

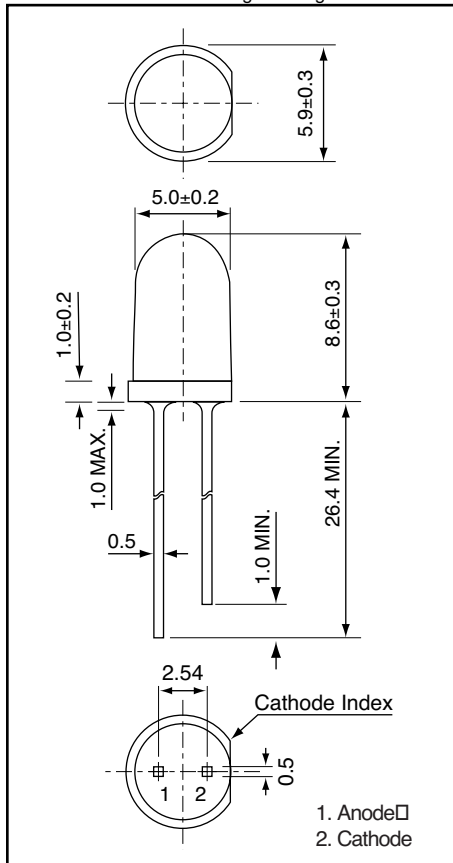

Weight: 0.31g Unit: mm



AND520HB

GaN High Brightness Blue Light Emission

- 5 mm (T1-3/4) Package
- Peak wavelength ($\lambda_p = 466\text{nm}$) high bright emission
- All plastic mold type, clear colorless lens
- Low drive current: 1 to 20 mA DC
- Excellent On-Off contrast ratio
- Fast response time, capable of pulse operation
- High power intensity – suitable for Outdoor Message Signboards
- High reliability
- **RoHS Compliant**

Maximum Ratings ($T_a = 25^\circ\text{C}$)

Characteristics	Symbol	Rating	Unit
Forward Current	I_F	30	mA
Reverse Voltage	V_R	5	V
Power Dissipation	P_D	120	mW
Operating Temperature Range	T_{Opr}	-40 to 85	C
Storage Temperature Range	T_{Sig}	-40 to 100	C

Electro-Optical Characteristics ($T_a = 25^\circ\text{C}$)

Characteristics	Symbol	Test Condition	Minimum	Typical	Maximum	Unit
Forward Voltage	V_F	$I_F = 20\text{ mA}$	–	3.5	4.0	V
Reverse Current	I_R	$V_R = 5\text{V}$	–	–	10	μA
Luminous Intensity	I_V	$I_F = 20\text{ mA}$	630	900	–	mcd
Peak Emission Wavelength	λ_p	$I_F = 20\text{ mA}$	–	475	–	nm
Spectral Line Half Width	$\Delta\lambda$	$I_F = 20\text{ mA}$	–	35	–	nm
Dominant Wavelength	λ_d	$I_F = 20\text{ mA}$	–	470	–	nm
Full Viewing Angle	q	$I_V = 1/2\text{ Peak}$	–	20	–	degree

Precaution

Please be careful of the following:

1. Soldering temperature: 260 C max.
Soldering time: 5 sec. max.
Soldering portion of lead: up to 1.6 mm from the body of the device
2. The lead can be formed up to 5 mm from the body of the device without forming stress.
Soldering should be performed after the lead forming.
3. Absolute secure counter measures against static electricity and surge should be taken when handling these products. It is recommended to use wrist band or antistatic gloves when handling these LEDs.

Product specifications contained herein may be changed without prior notice.

It is therefore advisable to contact Purdy Electronics before proceeding with the design of equipment incorporating this product.

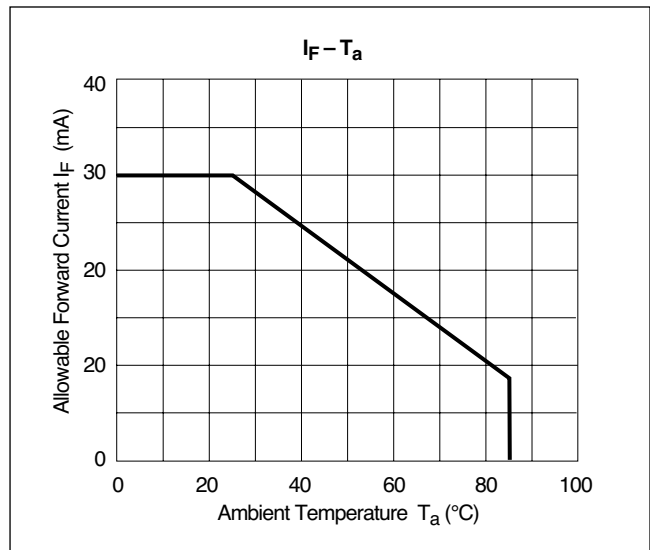
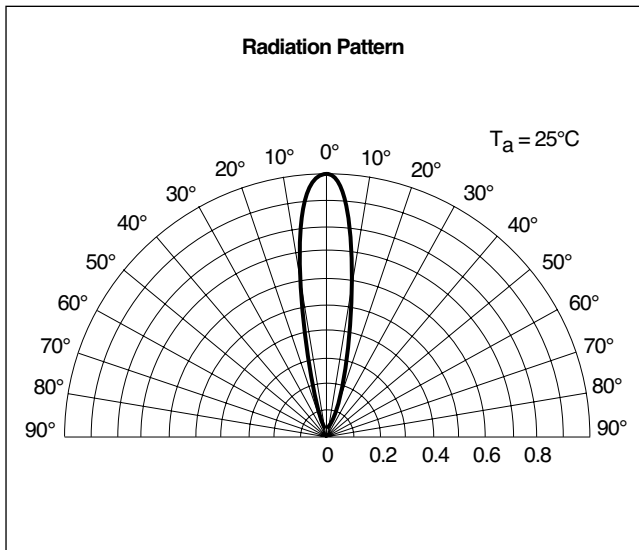
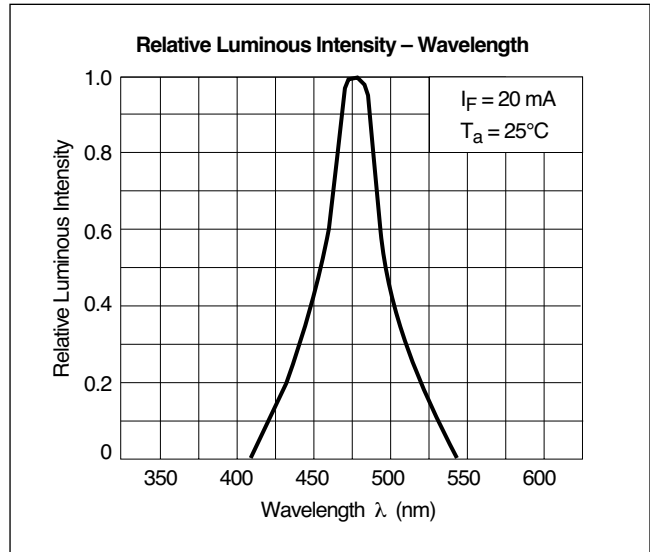
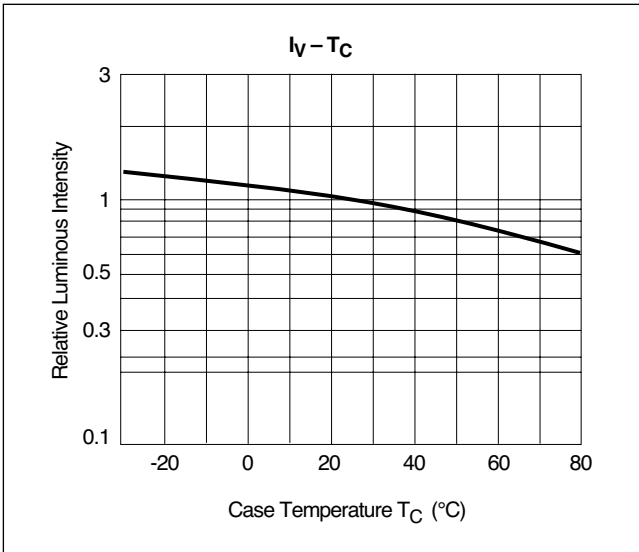
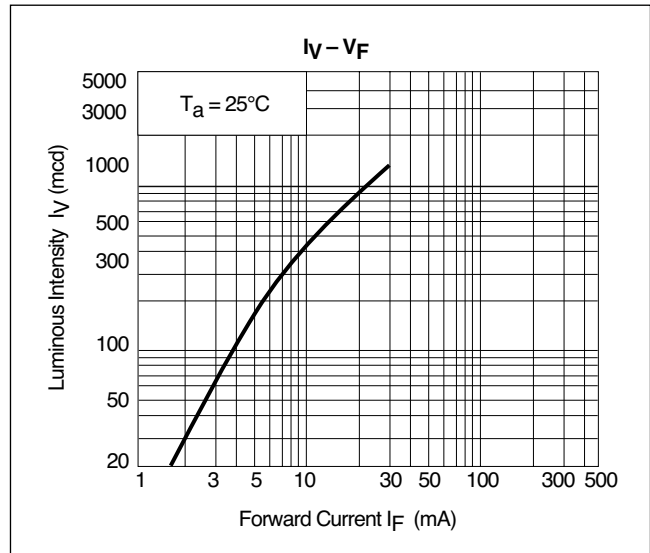
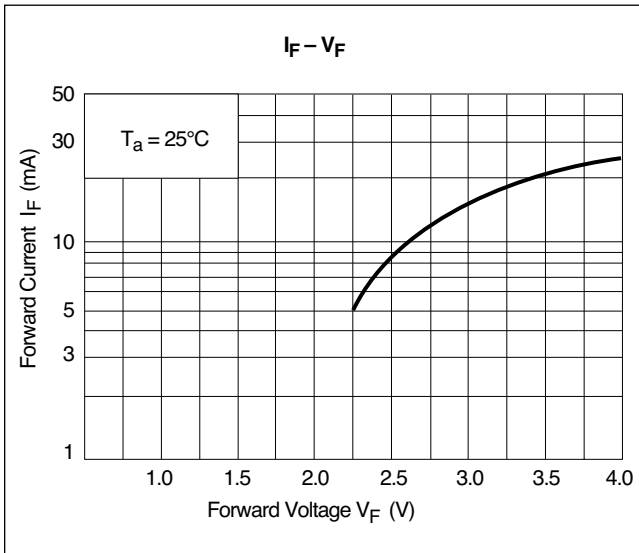

X-ON Electronics

Largest Supplier of Electrical and Electronic Components

Click to view similar products for [and manufacturer:](#)

Other Similar products are found below :

[EVB5.1 V5 ATMEGA32](#) [AND241](#) [AND113Y](#) [AVRPROG-MKII-ECO](#) [AND130CR](#) [AND113R](#) [AND180AYP](#) [AND721GST-LED](#)
[FE0203W-DU](#) [AND155CRP](#) [AND114YP](#) [FE0206W-DU](#) [AND262HBA](#) [AND113GP](#) [AND2451RGL](#) [AND114-R](#) [AND124R](#) [AND123R](#)
[AND120CRP](#) [AND240GCP](#)