

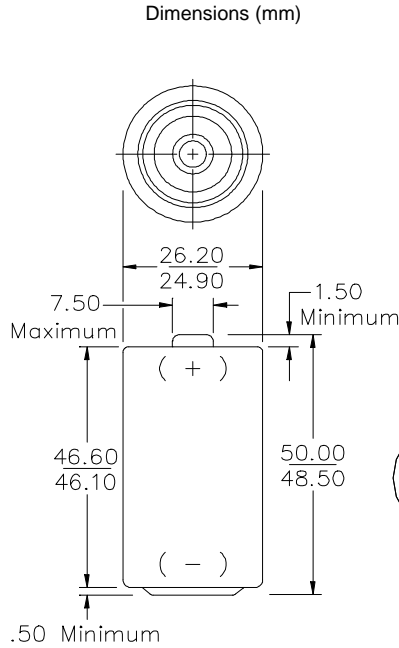

Engineering Data

C
Alkaline 1.5V
 No Added Mercury or Cadmium

ENERGIZER NO. E93



Millimeters	Inches
0.50	0.020
1.50	0.059
7.50	0.295
13.31	0.524
13.47	0.530
24.90	0.980
26.20	1.031
46.10	1.815
46.60	1.835
48.50	1.909
50.00	1.969

Chemical System: Zinc-Manganese Dioxide (Zn/MnO₂)

Designation: ANSI-14A, IEC-LR14

Battery Voltage: 1.5 Volts

Average Weight: 66.2 grams (2.3 oz.)

Volume: 26.9 cubic centimeters (1.6 cubic inch)

Average Service capacity (to 0.8 Volts / cell): 8350 mAh

(Rated Capacity at 25 mA continuous drain)

Cell: One No. 3-335 (size "C")

Jacket: Plastic Label

Shelf Life: 7 years

Temperature Effects
Typical Service to 0.8 Volts

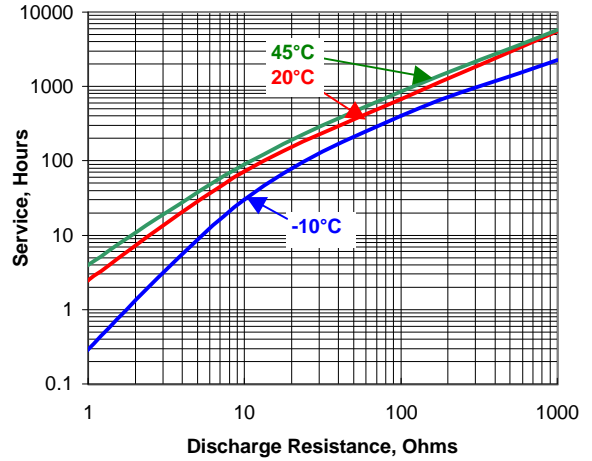

Constant Resistance Discharge
Typical Service

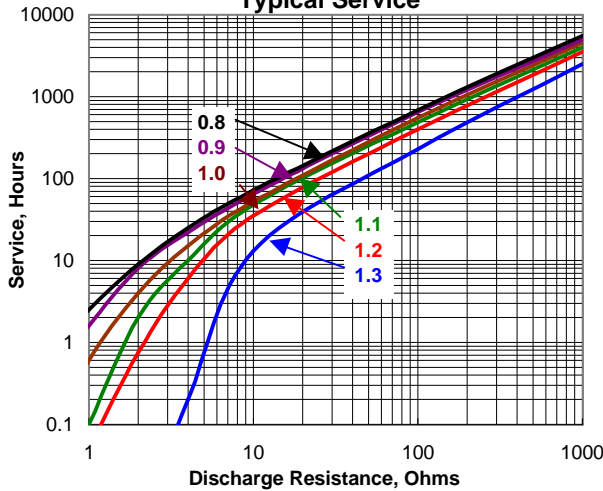

Constant Current Discharge
Typical Service

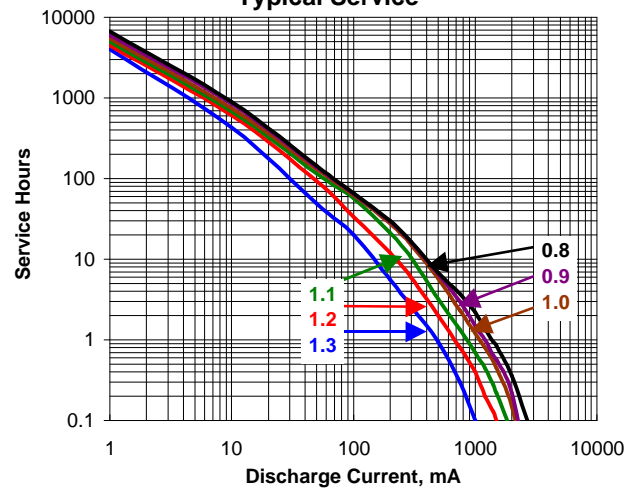

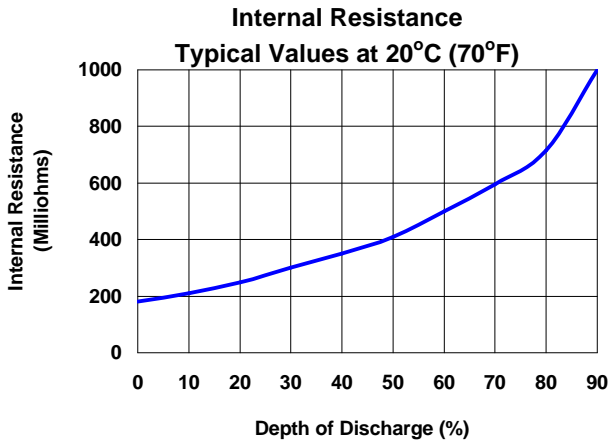

Typical Applications

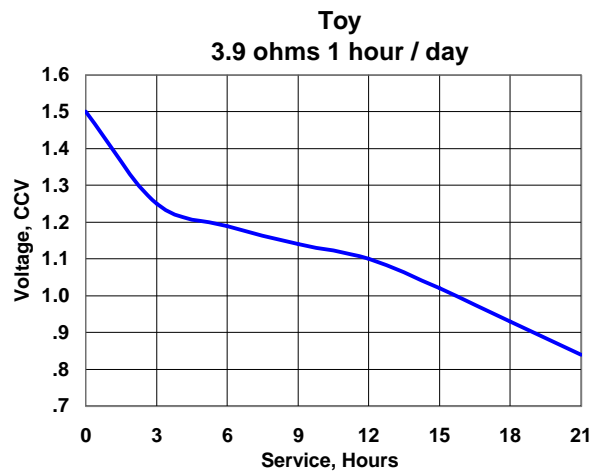
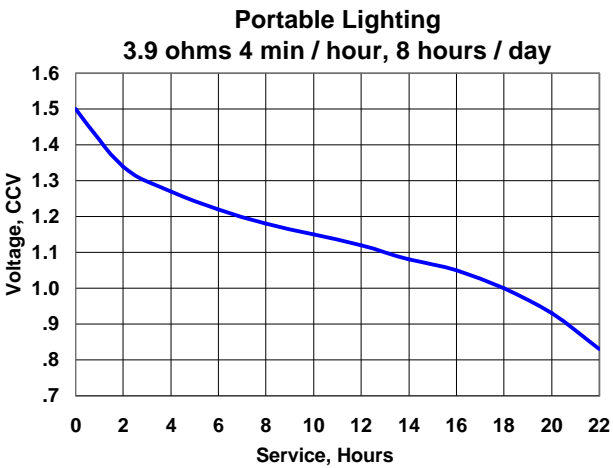
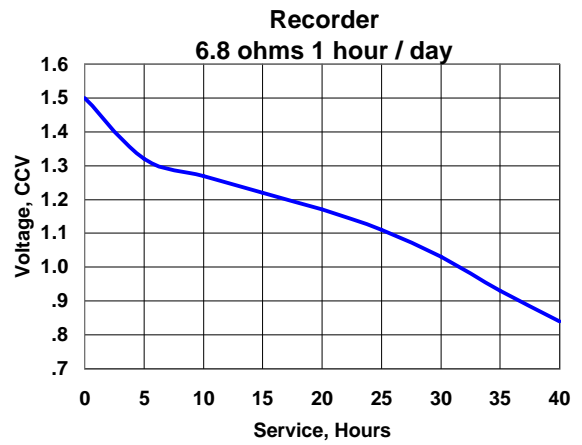
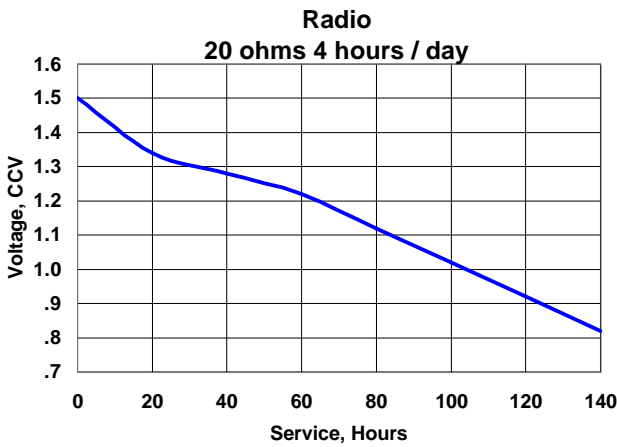

Important Notice

This data sheet contains information specific to batteries manufactured at time of its publication. Please contact your Energizer representative for most current information. Contents herein do not constitute a warranty.

X-ON Electronics

Largest Supplier of Electrical and Electronic Components

Click to view similar products for [energizer manufacturer](#):

Other Similar products are found below :

[A544](#) [1215F2X3](#) [E11A B2](#) [LR43 186](#) [AC13](#) [AC312](#) [AC675](#) [3LR12](#) [603298](#) [625302](#) [625304](#) [635706](#) [637871](#) [638006](#) [639830](#) [S9025](#)
[7638900426687](#) [7638900414660](#) [E92 MAX](#) [E91 MAX](#) [HARD CASE RECHARGEABLE](#) [HARD CASE PRO MULTI USE](#) [HCHD311](#)
[S9029](#) [639826](#) [603386](#) [HARD CASE PROFF 4AA](#) [HARDCASE PRO HEADLIGHT](#) [639618](#) [RCLINM2WR](#) [S8865](#) [S8707](#) [S8100](#)
[7638900424478](#) [7638900313130](#) [626177](#) [E300116200](#) [639838](#) [HARDCASE PRO WORK LIGHT](#) [603305](#) [E300280600](#) [METAL LED 6AA](#)
[S8864](#) [HDD32E](#) [MS2AALED](#) [ENERGIZER® 2-IN-1 LANTERN HANDHELD](#) [E300124200](#) [E300171700](#) [ENFFL81E](#) [E300112600](#)