

## T18 Sensors – ac-Voltage Series

Self-contained ac-operated sensors



### Features

- Featuring EZ-BEAM<sup>®</sup> technology, the specially-designed optics and electronics provide reliable sensing without the need for adjustments (most models)
- “T” style plastic housing with 18 mm threaded lens mount
- Models available in opposed, retroreflective, diffuse and fixed-field modes
- Completely epoxy-encapsulated to provide superior durability, even in harsh sensing environments to IP69K
- Innovative dual-indicator system takes the guesswork out of sensor performance monitoring
- 20 to 250V ac (3-wire hookup); SPST solid-state switch output, maximum load 300 mA

### Models

Sensing Mode		Range	LED	Output	Model*
	<b>Opposed</b>	20 m (66')	Infrared 950 nm	–	<b>T183E</b>
				LO	<b>T18AW3R</b>
	DO	<b>T18RW3R</b>			
	LO	<b>T18AW3L</b>			
	DO	<b>T18RW3L</b>	Visible Red 680 nm	LO	<b>T18AW3LP</b>
	DO	<b>T18RW3LP</b>			
	<b>Diffuse</b> with Gain Control	300 mm (12")	Infrared 880 nm	LO	<b>T18AW3D</b>
				DO	<b>T18RW3D</b>
	<b>Fixed-Field</b>	25 mm (1") cutoff		LO	<b>T18AW3FF25</b>
		50 mm (2") cutoff		DO	<b>T18RW3FF25</b>
		100 mm (4") cutoff		LO	<b>T18AW3FF50</b>
		DO		<b>T18RW3FF50</b>	
		LO	<b>T18AW3FF100</b>		
		DO	<b>T18RW3FF100</b>		

\* Standard 2 m (6.5') cable models are listed.

• **9 m (30') cable:** add suffix “W/30” (e.g., **T183E W/30**).

• **4-pin Micro-style QD models:** add suffix “Q1” (e.g., **T183EQ1**). A model with a QD connector requires a mating cable. (See page 7.)

† Use polarized models when shiny objects will be sensed.



#### WARNING . . . Not To Be Used for Personnel Protection

**Never use these products as sensing devices for personnel protection. Doing so could lead to serious injury or death.**

These sensors do NOT include the self-checking redundant circuitry necessary to allow their use in personnel safety applications. A sensor failure or malfunction can cause either an energized or de-energized sensor output condition. Consult your current Banner Safety Products catalog for safety products which meet OSHA, ANSI and IEC standards for personnel protection.

## Fixed-Field Mode Overview

T18 Series self-contained fixed-field sensors are small, powerful, infrared diffuse mode sensors with far-limit cutoff (a type of background suppression). Their high excess gain and fixed-field technology allow them to detect objects of low reflectivity, while ignoring background surfaces.

The cutoff distance is fixed. Backgrounds and background objects must *always* be placed beyond the cutoff distance.

### Fixed-Field Sensing – Theory of Operation

The T18FF compares the reflections of its emitted light beam (E) from an object back to the sensor's two differently aimed detectors, R1 and R2 (see Figure 1). If the near detector (R1) light signal is stronger than the far detector (R2) light signal (see object A, closer than the cutoff distance), the sensor responds to the object. If the far detector (R2) light signal is stronger than the near detector (R1) light signal (see object B, beyond the cutoff distance), the sensor ignores the object.

The cutoff distance for model T18FF sensors is fixed at 25, 50 or 100 millimeters (1", 2", or 4"). Objects lying beyond the cutoff distance usually are ignored, even if they are highly reflective. However, it is possible to falsely detect a background object, under certain conditions (see Background Reflectivity and Placement).

In the drawings and discussion on these pages, the letters E, R1, and R2 identify how the sensor's three optical elements (Emitter "E", Near Detector "R1", and Far Detector "R2") line up across the face of the sensor. The location of these elements defines the sensing axis (see Figure 2). The sensing axis becomes important in certain situations, such as those illustrated in Figures 5 and 6.

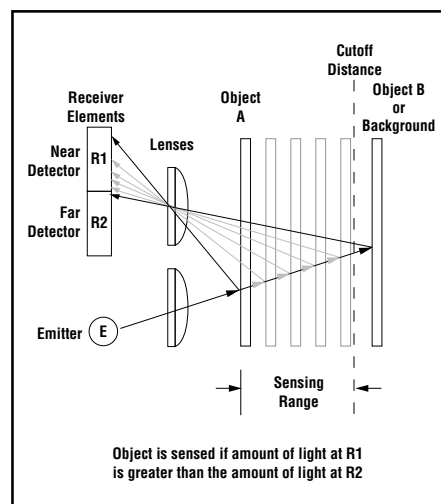

Figure 1. Fixed-field concept

## Sensor Setup

### Sensing Reliability

For highest sensitivity, position the target object for sensing at or near the point of maximum excess gain. The excess gain curves for these products are shown on page 5. They show excess gain vs. sensing distance for sensors with 25 mm, 50 mm, and 100 mm (1", 2", and 4") cutoffs. Maximum excess gain for the 25 mm models occurs at a lens-to-object distance of about 7 mm; for 50 mm models, at about 10 mm; and for the 100 mm models, at about 20 mm. Sensing at or near this distance will make maximum use of each sensor's available sensing power. The background must be placed beyond the cutoff distance. (Note that the reflectivity of the background surface also may affect the cutoff distance.) Following these two guidelines will improve sensing reliability.

### Background Reflectivity and Placement

*Avoid mirror-like backgrounds that produce specular reflections.* False sensor response will occur if a background surface reflects the sensor's light more strongly to the near detector, or "sensing" detector (R1), than to the far detector, or "cutoff" detector (R2). The result is a false ON condition (Figure 3). To cure this problem, use a diffusely reflective (matte) background, or angle either the sensor or the background (in any plane) so the background does not reflect light back to the sensor (see Figure 4). Position the background as far beyond the cutoff distance as possible.

An object beyond the cutoff distance, either stationary (and when positioned as shown in Figure 5), or moving past the face of the sensor in a direction perpendicular to the sensing axis, can cause unwanted triggering of the sensor if more light is reflected to the near detector than to the far detector. The problem is easily remedied by rotating the sensor 90° (Figure 6). The object then reflects the R1 and R2 fields equally, resulting in no false triggering. A better solution, if possible, may be to reposition the object or the sensor.

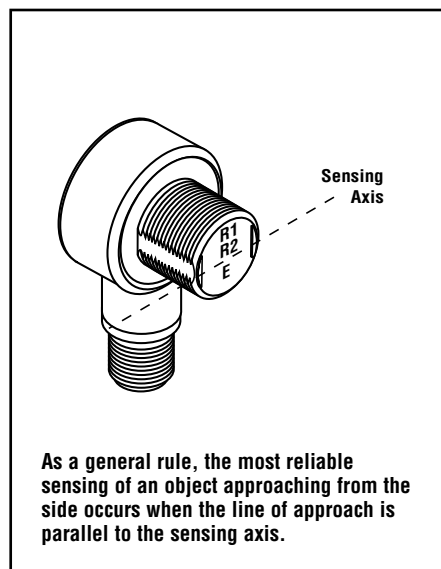

Figure 2. Fixed-field sensing axis

As a general rule, the most reliable sensing of an object approaching from the side occurs when the line of approach is parallel to the sensing axis.

## Color Sensitivity

The effects of object reflectivity on cutoff distance, though small, may be important for some applications. It is expected that at any given cutoff setting, the actual cutoff distance for lower reflectance targets will be slightly shorter than for higher reflectance targets (see Figure-of-Merit information on page 5). This behavior is known as color sensitivity.

For example, an excess gain of 1 (see page 5) for an object that reflects 1/10 as much light as the 90% white card is represented by the horizontal graph line at excess gain = 10. An object of this reflectivity results in a far limit cutoff of approximately 20 mm (0.8"), for the 25 mm (1") cutoff models for example; thus 20 mm represents the cutoff for this sensor and target.

These excess gain curves were generated using a white test card of 90% reflectance. Objects with reflectivity of less than 90% reflect less light back to the sensor, and thus require proportionately more excess gain in order to be sensed with the same reliability as more reflective objects. When sensing an object of very low reflectivity, it may be especially important to sense it at or near the distance of maximum excess gain.

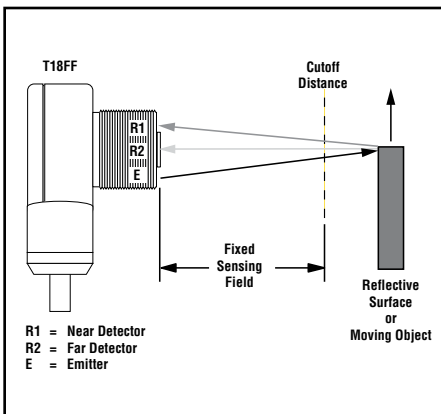

Figure 3. Reflective background – problem

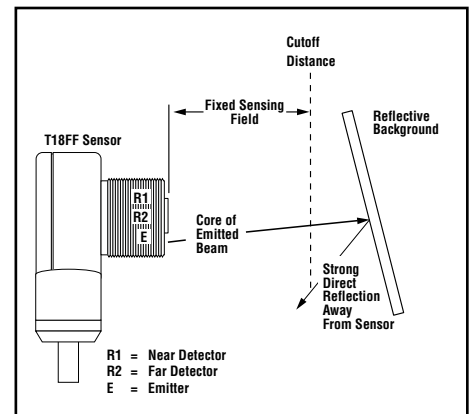

Figure 4. Reflective background – solution

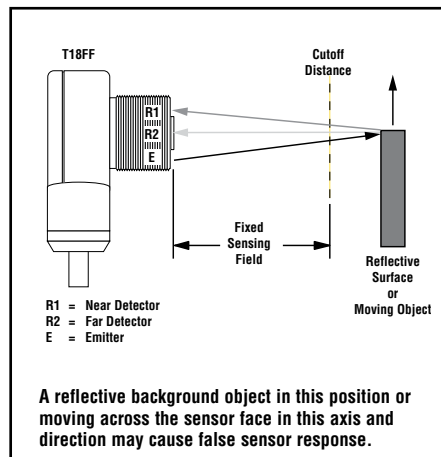

Figure 5. Object beyond cutoff – problem

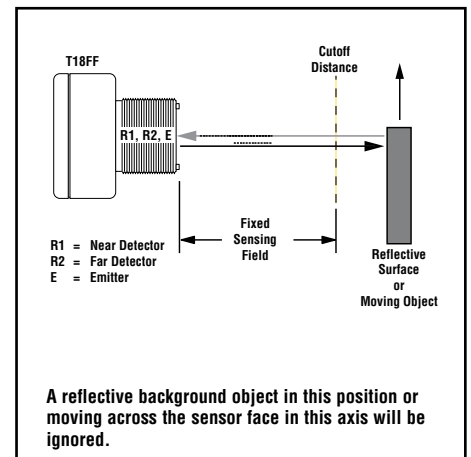



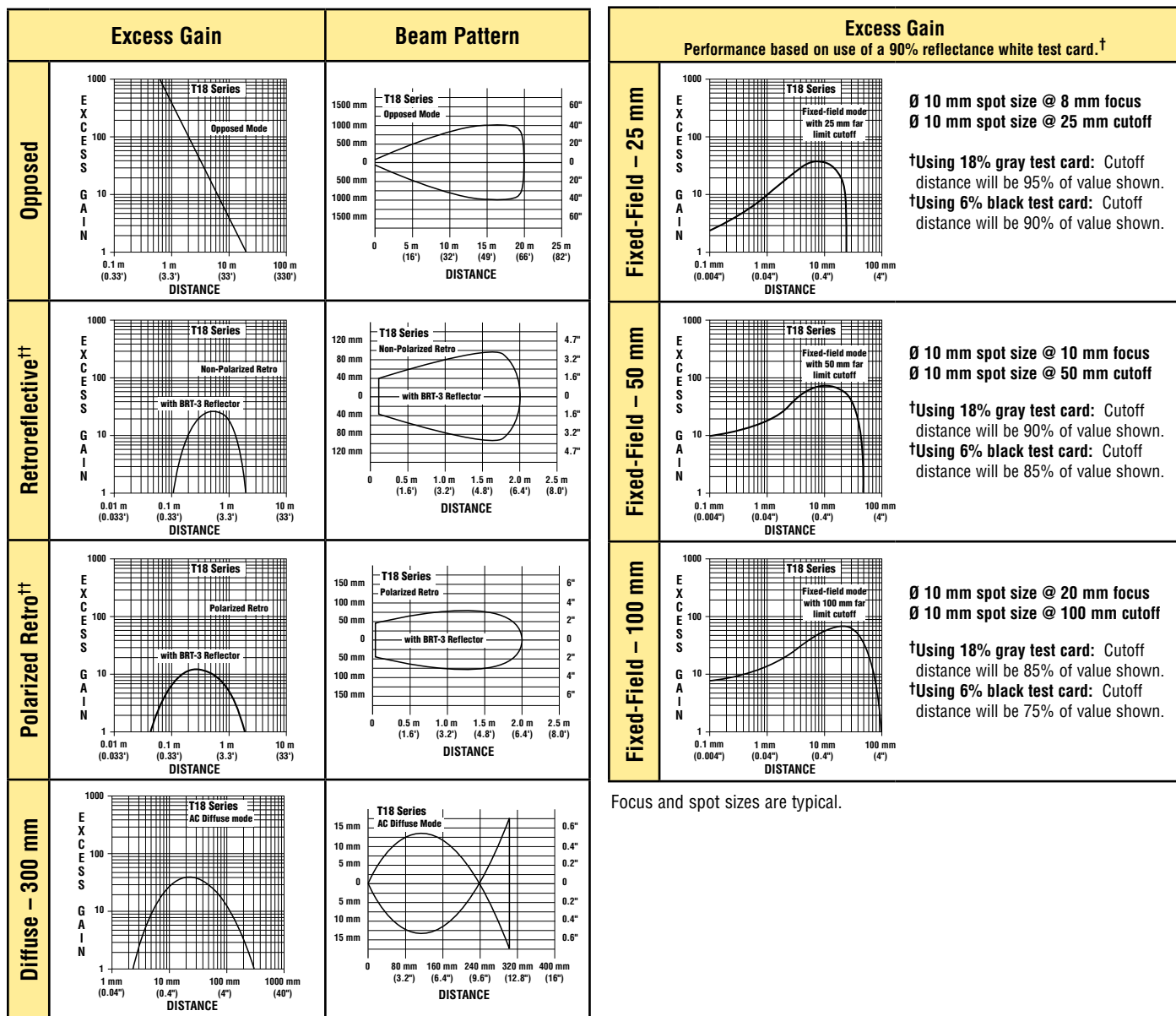

Figure 6. Object beyond cutoff – solution

## Specifications

<b>Supply Voltage and Current</b>	20 to 250V ac (50/60 Hz) <b>Average current:</b> 20 mA <b>Peak current:</b> 200 mA @ 20V ac, 500 mA @ 120V ac, 750 mA @ 250V ac
<b>Supply Protection Circuitry</b>	Protected against transient voltages
<b>Output Configuration</b>	SPST solid-state ac switch; three-wire hookup; light operate or dark operate, depending on model <i>Light Operate:</i> Output conducts when sensor sees its own (or the emitter's) modulated light <i>Dark Operate:</i> Output conducts when the sensor sees dark
<b>Output Rating</b>	300 mA maximum (continuous) <b>Fixed-Field models:</b> derate 5 mA/°C above +50° C (+122° F) <b>Inrush capability:</b> 1 amp for 20 milliseconds, non-repetitive <b>OFF-state leakage current:</b> < 100 microamps <b>ON-state saturation voltage:</b> 3V @ 300 mA ac; 2V @ 15 mA ac
<b>Output Protection Circuitry</b>	Protected against false pulse on power-up
<b>Output Response Time</b>	<b>Opposed mode:</b> 16 milliseconds ON, 8 milliseconds OFF <b>Other models:</b> 16 milliseconds ON and OFF NOTE: 100 millisecond delay on power-up; outputs do not conduct during this time.
<b>Repeatability</b>	<b>Opposed mode:</b> 2 milliseconds <b>Other models:</b> 4 milliseconds Repeatability and response are independent of signal strength.
<b>Adjustments</b>	Non-polarized retro and diffuse models (only) have a single-turn rear-panel Sensitivity control (turn clockwise to increase gain).
<b>Indicators</b>	Two LEDs (Green and Yellow) <b>Green ON steady:</b> power to sensor is ON <b>Yellow ON steady:</b> sensor sees light <b>Yellow flashing:</b> excess gain marginal (1 to 1.5x) in light condition
<b>Construction</b>	PBT polyester housing; polycarbonate (opposed-mode) or acrylic lens
<b>Environmental Rating</b>	Leakproof design rated NEMA 6P, DIN 40050 (IP69K)
<b>Connections</b>	2 m (6.5') attached cable or 4-pin Micro-style quick-disconnect fitting
<b>Operating Conditions</b>	<b>Temperature:</b> -40° to +70° C (-40° to +158° F) <b>Maximum relative humidity:</b> 90% at 50° C (non-condensing)
<b>Vibration and Mechanical Shock</b>	All models meet Mil. Std. 202F requirements. Method 201A (Vibration; frequency 10 to 60 Hz, max., double amplitude 0.06" acceleration 10G). Method 213B conditions H&I (Shock: 75G with unit operating; 100G for non-operation)
<b>Certifications</b>	  

## Performance Curves



Focus and spot sizes are typical.

††Performance based on use of a model BRT-3 retroreflector (3" diameter).

Actual sensing range may be more or less than specified, depending on the efficiency and reflective area of the retroreflector used.

## Dimensions

### Cabled Models

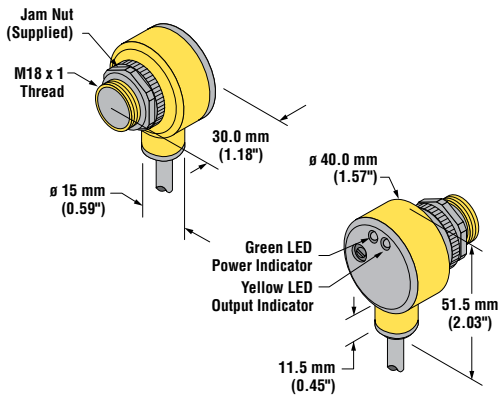

### QD Models

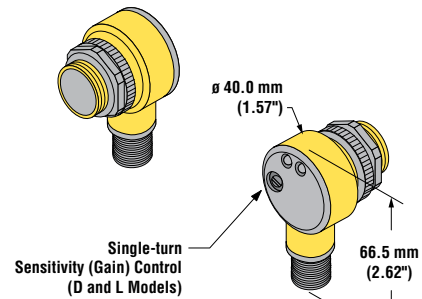

## Hookups

### Cabled Emitters

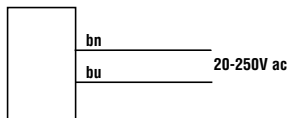

### QD Emitters (4-pin Micro-Style)

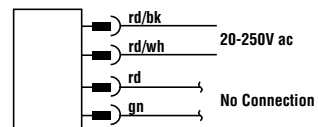

### All Other Cabled Models

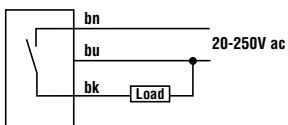

### All Other QD Models (4-pin Micro-Style)

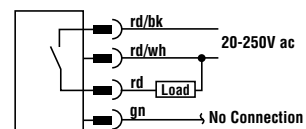

## Quick-Disconnect (QD) Cables

Style	Model	Length	Dimensions	Pinout
4-pin Micro-style Straight	<b>MQAC-406</b> <b>MQAC-415</b> <b>MQAC-430</b>	2 m (6.5') 5 m (15') 9 m (30')		
4-pin Micro-style Right-angle	<b>MQAC-406RA</b> <b>MQAC-415RA</b> <b>MQAC-430RA</b>	2 m (6.5') 5 m (15') 9 m (30')		



more sensors, more solutions

**WARRANTY:** Banner Engineering Corp. warrants its products to be free from defects for one year. Banner Engineering Corp. will repair or replace, free of charge, any product of its manufacture found to be defective at the time it is returned to the factory during the warranty period. This warranty does not cover damage or liability for the improper application of Banner products. This warranty is in lieu of any other warranty either expressed or implied.

## X-ON Electronics

Largest Supplier of Electrical and Electronic Components

*Click to view similar products for [banner manufacturer](#):*

Other Similar products are found below :

[Q45VR2FPQ](#) [BTA23S](#) [RS-11](#) [L16F](#) [2LM3](#) [2PBA](#) [LM8-1](#) [LMT](#) [SM312CV](#) [SM31RQD](#) [LS4ELQ](#) [FX1](#) [Q45BB6LLQ](#) [QM42VP6AFV150Q](#)  
[D12SP6FP](#) [MBCC-412](#) [BA23S](#) [BT21S](#) [BTA13S](#) [LM4-2](#) [Q25SP6LPQ](#) [ES-FA-6G](#) [T183E](#) [SLSP30-600Q88](#) [SLSP30-1200Q88](#) [OTBVN6QD](#)  
[OPBA5](#) [PBAT](#) [SBLV1](#) [SMA91EQD](#) [SMA91E](#) [SMA912LVQD](#) [SMA912DQD](#) [SM2A312CVQD](#) [SM2A912LVQD](#) [SM312FP1H](#) [SM31RL](#)  
[TL70RAQ](#) [TL70RQ](#) [K50LGRYPQ](#) [LEDRR70X70-78587](#) [BRT-THG-4X4-5](#) [T18-2VNDL-Q8](#) [SLLP14-1190P88](#) [SME312DQD](#)  
[SM312CUQD](#) [BR-2](#) [BR23P](#) [SM2A312FPQD](#) [SM2A312LVQD](#)