



Eveready Battery Company, Inc.

533 Maryville University Drive
 St. Louis, MO 63141
 Telephone 1-800-383-7323
 Internet: www.energizer.com

Engineering Data

AA
Alkaline 1.5V
 No Added Mercury or Cadmium

ENERGIZER NO. E91

Dimensions (mm)

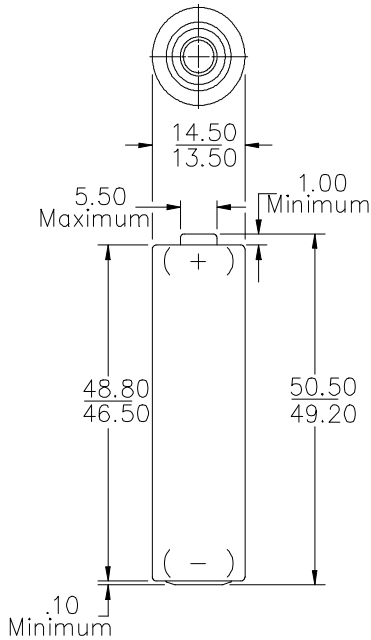

| Millimeters | Inches |
|-------------|--------|
| 0.1 | 0.004 |
| 1.0 | 0.039 |
| 5.5 | 0.217 |
| 13.5 | 0.531 |
| 14.5 | 0.571 |
| 46.5 | 1.831 |
| 48.8 | 1.921 |
| 49.2 | 1.937 |
| 50.5 | 1.988 |

Chemical System: Zinc-Manganese Dioxide (Zn/MnO₂)

Designation: ANSI-15A, IEC-LR6

Battery Voltage: 1.5 Volts

Average Weight: 23 grams (0.8oz.)

Volume: 8.1 cubic centimeters (0.5cubic inch)

Average Service capacity (to 0.8Volts / cell): 2850 mAh
 (Rated Capacity at 25 mA continuous drain)

Cell: One No. 3-315 (size "AA")

Jacket: Plastic Label

Shelf Life: 7 years

Temperature Effects Typical Service to 0.8 Volts

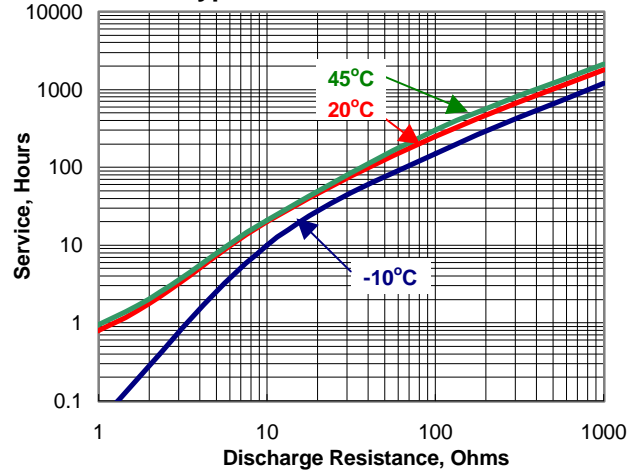

Constant Resistance Discharge Typical Service

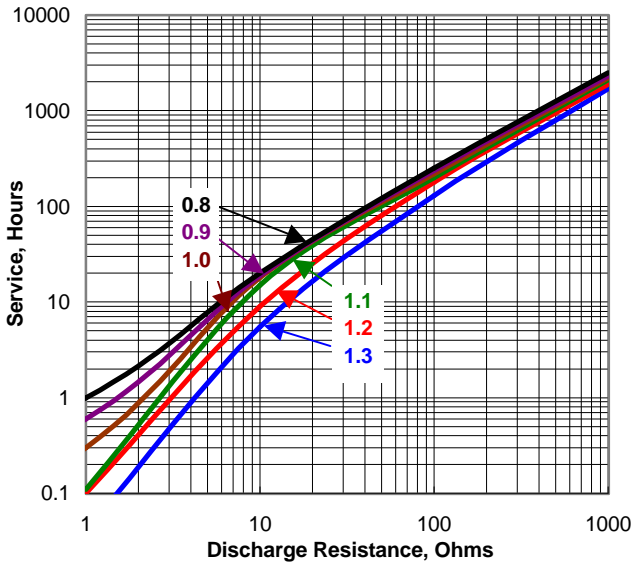

Constant Current Discharge Typical Service

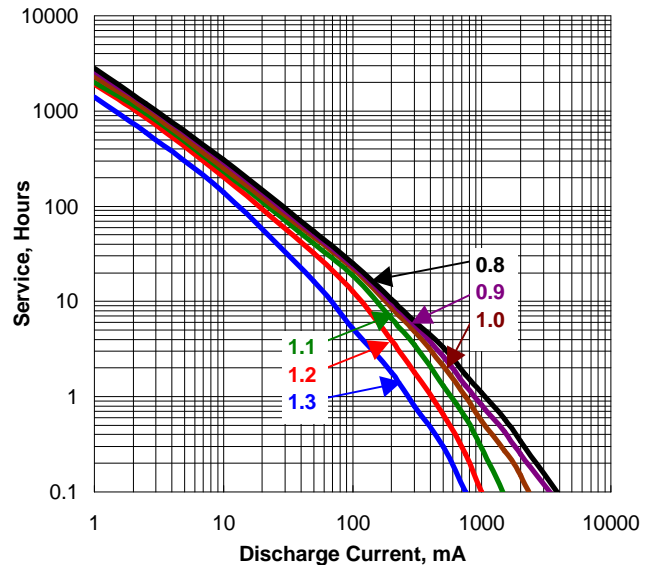

ENERGIZER NO. E91

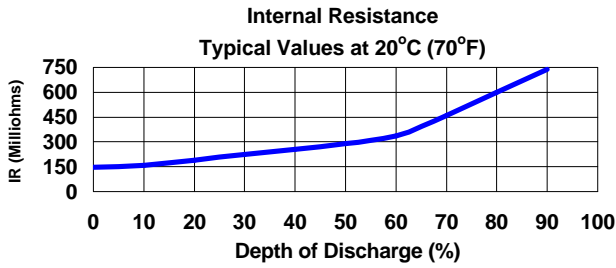

Typical Applications

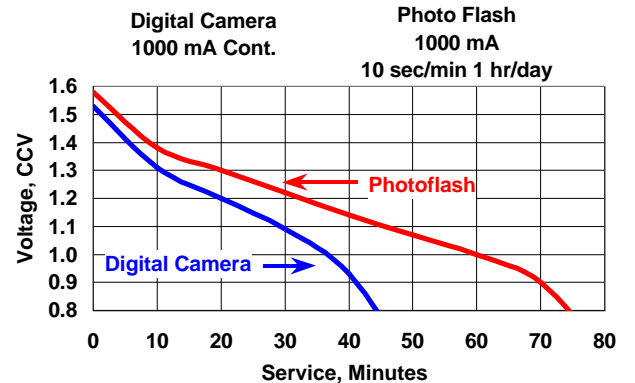
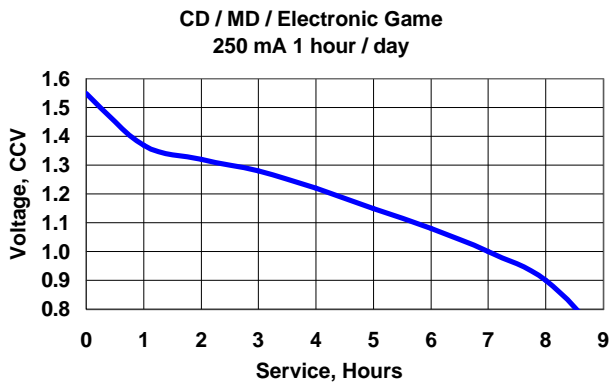
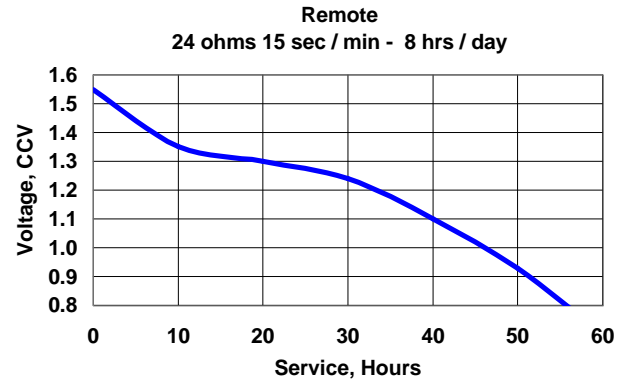
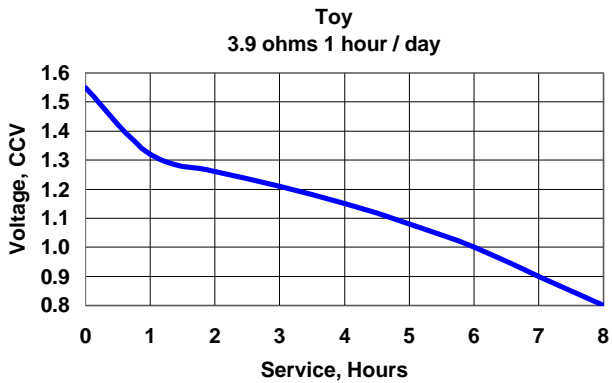
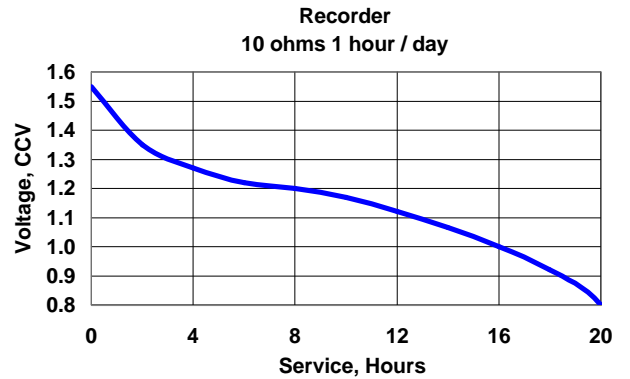
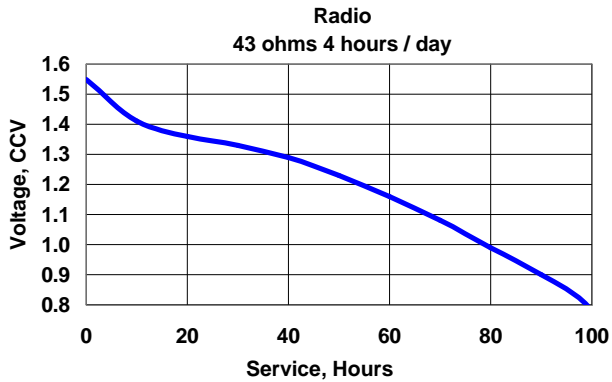

Important Notice

This data sheet contains information specific to batteries manufactured at time of its publication. Please contact your Energizer representative for most current information. Contents herein do not constitute a warranty.

X-ON Electronics

Largest Supplier of Electrical and Electronic Components

Click to view similar products for [energizer manufacturer](#):

Other Similar products are found below :

[A544](#) [1215F2X3](#) [E11A B2](#) [LR43 186](#) [AC13](#) [AC312](#) [AC675](#) [3LR12](#) [603298](#) [625302](#) [625304](#) [635706](#) [637871](#) [638006](#) [639830](#) [S9025](#)
[7638900426687](#) [7638900414660](#) [E92 MAX](#) [E91 MAX](#) [HARD CASE RECHARGEABLE](#) [HARD CASE PRO MULTI USE](#) [HCHD311](#)
[S9029](#) [639826](#) [603386](#) [HARD CASE PROFF 4AA](#) [HARDCASE PRO HEADLIGHT](#) [639618](#) [RCLINM2WR](#) [S8865](#) [S8707](#) [S8100](#)
[7638900424478](#) [7638900313130](#) [626177](#) [E300116200](#) [639838](#) [HARDCASE PRO WORK LIGHT](#) [603305](#) [E300280600](#) [METAL LED 6AA](#)
[S8864](#) [HDD32E](#) [MS2AALED](#) [ENERGIZER® 2-IN-1 LANTERN HANDHELD](#) [E300124200](#) [E300171700](#) [ENFFL81E](#) [E300112600](#)