

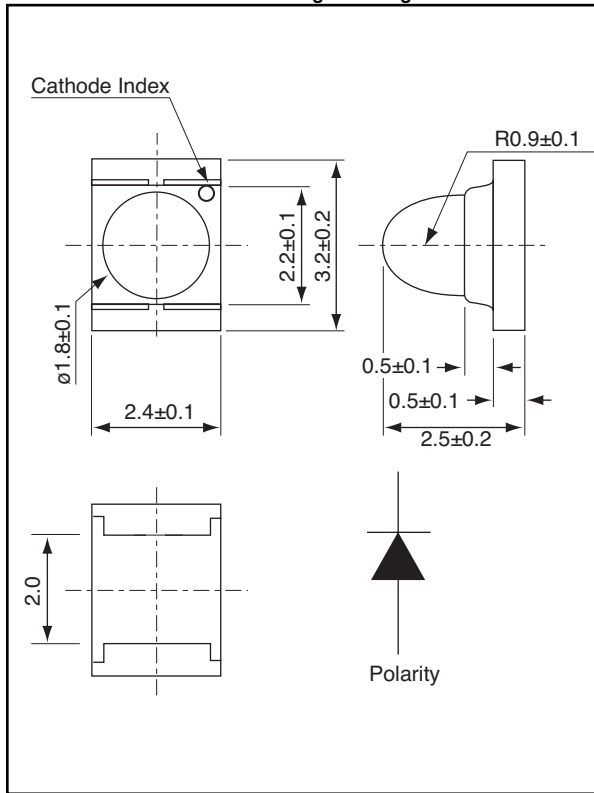

Weight: 2.0 mg Unit: mm



AND5YA

InGaAlP Ultra Bright Yellow Light Emission

Surface Mount Package

Features

- Small package size with dome lens
- 3.2 (l) x 2.4 (w) x 2.6 (h) size
- Suitable for REFLOW soldering
- Recommended Forward Current: 10 mA
- RoHS Compliant

Maximum Ratings (T_a = 25°C)

Characteristics	Symbol	Rating	Unit
Forward Current	I _F	25	mA
Reverse Voltage	V _R	5	V
Power Dissipation	P _D	100	mW
Operating Temperature Range	T _{Op}	-40 to 85	°C
Storage Temperature Range	T _{Stg}	-40 to 90	°C

Electro-Optical Characteristics (T_a = 25°C)

Characteristics	Symbol	Test Condition	Minimum	Typical	Maximum	Unit
Forward Voltage	V _F	I _F = 20 mA	-	2.1	2.4	V
Reverse Current	I _R	V _R = 5 V	-	-	25	μA
Luminous Intensity	I _V	I _F = 20 mA	395	625	-	mcd
Peak Emission Wavelength	I _P	I _F = 20 mA	-	591	-	nm
Spectral Line Half Width	Δλ	I _F = 20 mA	-	15	-	nm
Dominant Wavelength	λ _d	I _F = 20 mA	-	589	-	nm
Full Viewing Angle	θ	I _V = 1/2 Peak	-	30	-	degree

Precaution

Please be careful of the following:

1. Manual soldering: maximum temperature of iron tip: 260°C max.
Soldering time: within 5 sec. per solder-land
Soldering portion of lead: up to 1.6 mm from the body of the device
2. Reflow solder: recommended condition is as follows:

Product specifications contained herein may be changed without prior notice.

It is therefore advisable to contact Purdy Electronics before proceeding with the design of equipment incorporating this

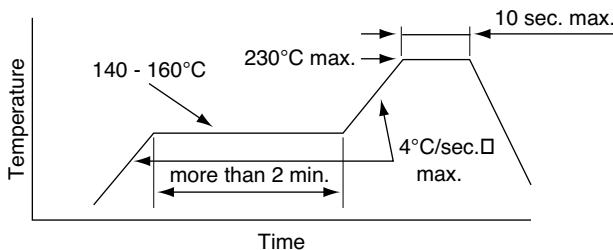

The following soldering patterns are recommended for reflow soldering

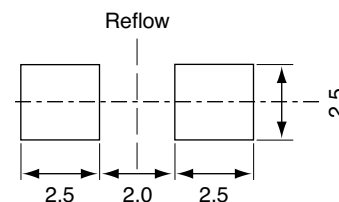

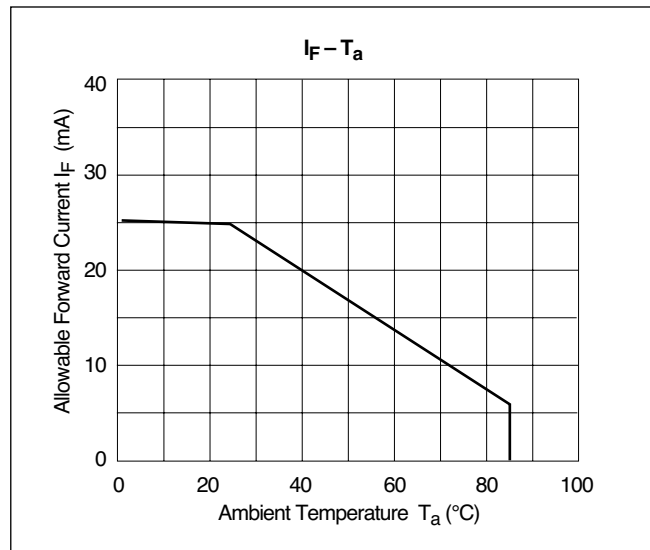
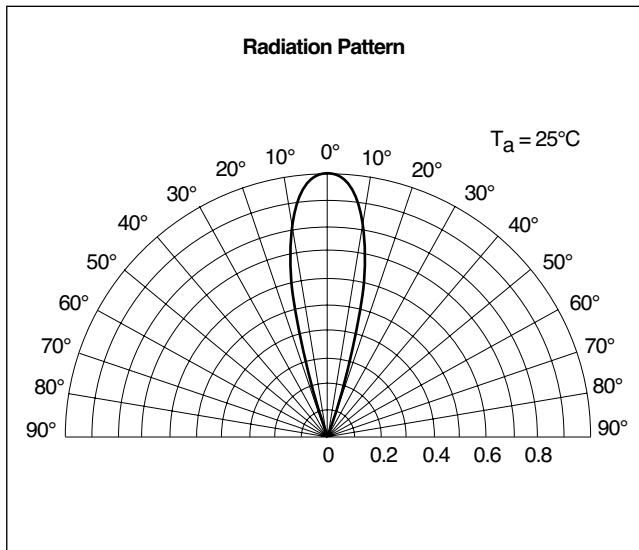
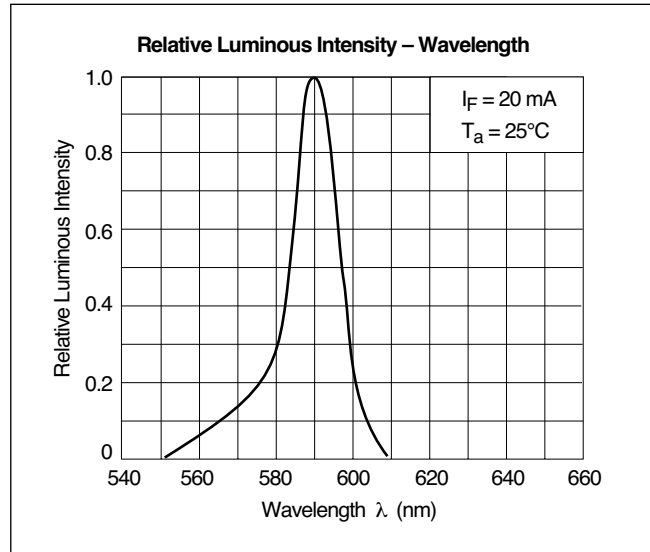
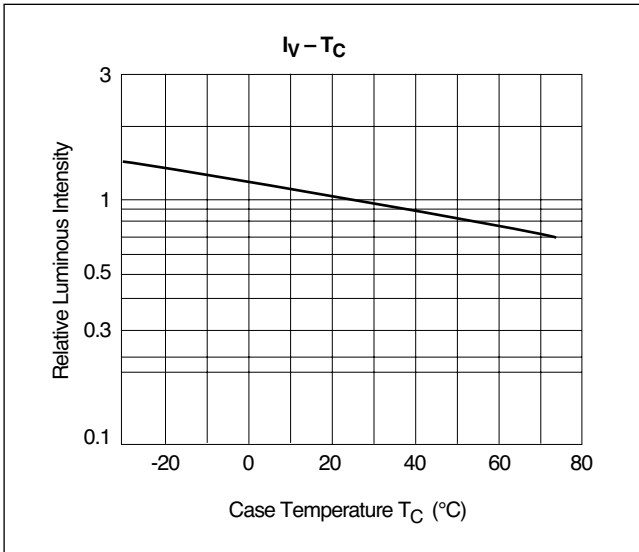
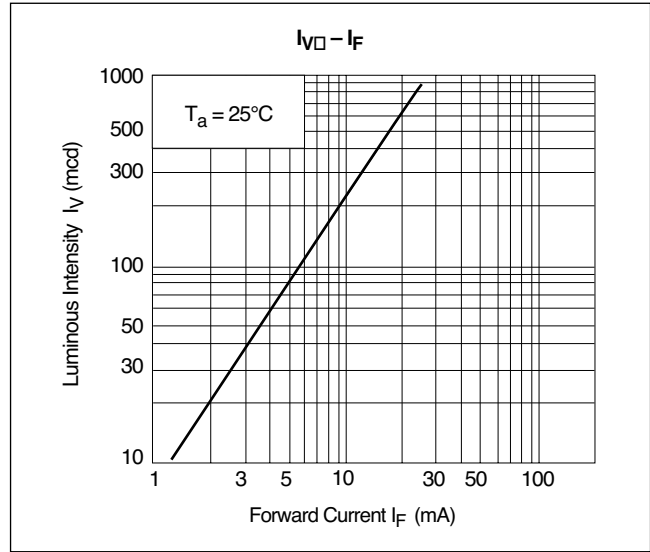
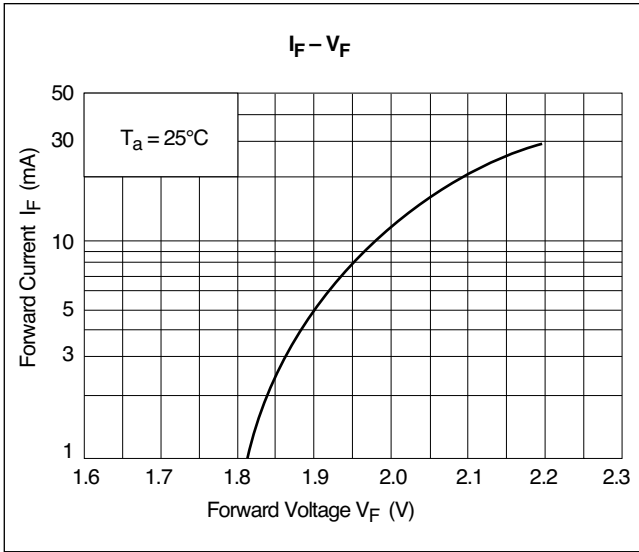

X-ON Electronics

Largest Supplier of Electrical and Electronic Components

Click to view similar products for [and manufacturer:](#)

Other Similar products are found below :

[EVB5.1 V5 ATMEGA32](#) [AND241](#) [AND113Y](#) [AVRPROG-MKII-ECO](#) [AND130CR](#) [AND113R](#) [AND180AYP](#) [AND721GST-LED](#)
[FE0203W-DU](#) [AND155CRP](#) [AND114YP](#) [FE0206W-DU](#) [AND262HBA](#) [AND113GP](#) [AND2451RGL](#) [AND114-R](#) [AND124R](#) [AND123R](#)
[AND120CRP](#) [AND240GCP](#)