

SERIES 1881 - SINGLE-POLE ROUND ROCKER SWITCHES

TO 12 (4) A 250 V AC



PRODUCT FEATURES

- ◆ Attractive round rocker switch
- ◆ High mechanical rating with at least 100 000 switching cycles
- ◆ Variants with IP 51
- ◆ Low depth with 18.7 mm
- ◆ Appliance cut-out with 20 mm

ON REQUEST























- ◆ Other colors
- ◆ Other printing variants
- ◆ Other terminal variants (e.g. PCB)
- ◆ Cable assembly
- ◆ Gold-plated contacts for low voltages
- ◆ Other switching functions (e.g. 1888 - middle off)
- ◆ Painted variants
- ◆ PVC-protection cap

Mechanical life endurance	10E4
Operating force	3 N
Inrush current (capacitive)	70 A
Contact resistance (new condition)	< 100 mOhm (1 A 12 V DC)
Insulation resistance (new condition)	> 100 MOhm (500 V DC)
Proof tracking	250 PTI
Protection type	IP 40 and IP 51 (product-dependent)
Ambient temperature	terminal side -20 °C ... +100 °C actuating side -20 °C ... +55 °C
Flammability	UL 94 V-2 UL 94 V-0 (product-dependent)
Glow wire test temperature	850 °C
Material	actuator PA housing PA terminals silver plated
Plug force of the terminals	≤ 80 N
Approval marks	
Suitable for appliances of protection class II	



SERIES 1881 - SINGLE-POLE ROUND ROCKER SWITCHES

TO 12 (4) A 250 V AC

 single-pole	Actuator color / printing	Housing color	12 (4) A 250 V AC 1E4	10 (4) A 250 V AC 1E4	8 (8) A 250 V AC 5E4	6 (4) A 250 V AV 5E4	15 A 250 V AC 1 1/2 HP	15 A 125 V AC 3/4 HP	10 A 250 V AC 1/2 HP	10 A 125 V AC 1/3 HP	Terminal type	Terminal description	Contact distance in mm	Contact material	Actuator	EN 60335 cap. 30 conform "G"	Miscellaneous	Stock version
	ON / OFF switch (SPST)																	
1881.1103		Black	●	●	●	●	●	●	●	●		4.8	≥ 3	Ag	IP 40			●
1881.1104		Black	●	●	●	●	●	●	●	●		4.8	≥ 3	Ag	IP 40			●
1881.1105		White	●	●	●	●	●	●	●	●		4.8	≥ 3	Ag	IP 40			
1881.1106		Black	●	●	●	●	●	●	●	●		4.8	≥ 3	Ag	IP 40	●		
1881.1108		Black	●	●	●	●	●	●	●	●		4.8	≥ 3	Ag	IP 51	●	with switching system cover	
1881.1109		Black	●	●	●	●	●	●	●	●		4.8	≥ 3	Ag	IP 40			
1881.1111		Black	●	●	●	●	●	●	●	●		4.8	≥ 3	Ag	IP 40			
1881.1112		White	●	●	●	●	●	●	●	●		1 mm longer 4.8	≥ 3	Ag	IP 51	●	with switching system cover	
Normally open contact (SPNO)																		
1881.1209		Black	●	●	●	●	●	●	●	●		4.8	≥ 3	Ag	IP 51		with switching system cover opening terminal 1b closed	
Changeover switch (SPDT)																		
1883.1105		Black	●	●	●	●	●	●	●	●		4.8	≥ 3	Ag	IP 40			
1883.1106		Black	●	●	●	●	●	●	●	●		4.8	≥ 3	Ag	IP 40	●		

ROCKER SWITCHES

PUSHBUTTON SWITCHES

TOGGLE SWITCHES

SLIDE SWITCHES

ROTARY SWITCHES

FOOT SWITCHES

FACT AND KEY SWITCHES

SNAP-ACTION SWITCHES

MICRO-SIGNAL SWITCHES

SENSORS

SERIES 1881 - SINGLE-POLE ROUND ROCKER SWITCHES

TO 12 (4) A 250 V AC



Basic type 1881

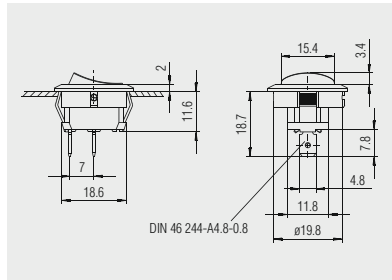

Quick-connect terminal 4.8 x 0.8

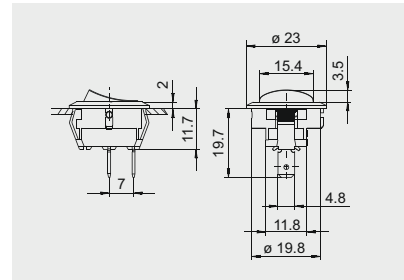

Quick-connect terminal 4.8 x 0.8
1 mm longer

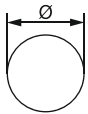

X = wall thickness

X	Ø
0.75 ... 1.25	20.3
1.25 ... 2	20.8
2 ... 3	21.1



Protection cap
on request

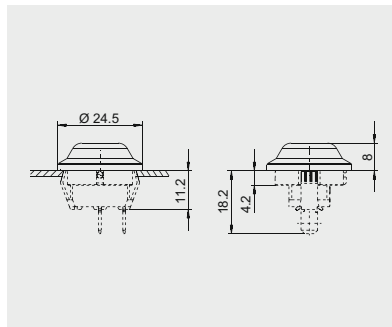

Transparent PVC-protection cap.
Serves as dust and water protection of
the actuation side.

SERIES 1855 - MINIATURE DOUBLE-POLE ROCKER SWITCHES

TO 4 (1) A 250 V AC





PRODUCT FEATURES

- ◆ Illuminated rocker switches
- ◆ Different lamp variants
- ◆ Powerful with 50 000 mechanical switching cycles
- ◆ Caulked terminals for reliable plugging of the receptacles

ON REQUEST

- ◆ Other colors
- ◆ Other printing variants
- ◆ Other terminal types
- ◆ Other lamp variants
- ◆ Cable assembly

Mechanical life endurance	5E4
Contact resistance (new condition)	< 100 mOhm (1 A 12 V DC)
Insulation resistance (new condition)	> 100 MOhm (500 V DC)
Proof tracking	250 PTI
Protection type	IP 40
Ambient temperature	terminal side -20 °C ... +85 °C actuating side -20 °C ... +55 °C
Flammability	UL 94 V-2
Glow wire test temperature	850 °C
Material	actuator PA housing PA terminals silver plated
Plug force of the terminals	≤ 80 N
Approval marks	 /  / 
Suitable for appliances of protection class II	



ROCKER SWITCHES

PUSHBUTTON SWITCHES

TOGGLE SWITCHES

SLIDE SWITCHES

ROTARY SWITCHES

FOOT SWITCHES

FACT AND KEY SWITCHES

SNAP-ACTION SWITCHES

MICRO-SIGNAL SWITCHES

SENSORS

X-ON Electronics

Largest Supplier of Electrical and Electronic Components

Click to view similar products for [Rocker Switches](#) category:

Click to view products by [Marquardt](#) manufacturer:

Other Similar products are found below :

[VKD2GHNB-00000-000](#) [VSD2GNNB-00000-000](#) [6-1571986-5](#) [6-1571986-9](#) [632422-4B-KD](#) [7036WWCDBX653+U622](#) [8055K52Z7V](#)
[8138K20E6M50](#) [FMC18A2200002](#) [84206L](#) [84312LX](#) [PREDD4-07F-BB0FW](#) [PREDD5-07F-BB0GW](#) [PRFDD1-16F-BB000](#) [PRFDD3-16F-](#)
[BB000](#) [1-1634201-0](#) [999-16702-001](#) [A101J2ZQ004](#) [A101J4ZQ004](#) [A101J51CB0004](#) [A107J51ZQ0004](#) [A201J1AQ004](#) [A201J1AV2Q004](#)
[A201J3ZB004](#) [A201J50ZQ004](#) [A203J51ZQ0004](#) [A226L11YZQ](#) [A22L11A](#) [A435S1YZQ](#) [H8500XBBBBL-A](#) [H8653VBBG2577W](#)
[HB130CHNWWNAAC](#) [1251.0303](#) [AE205J60V3B004](#) [RH110C2NBB](#) [1352.0107](#) [1363.0201](#) [AML25GBF2AA03GR](#) [1571099-3](#) [1571987-4](#)
[1571987-5](#) [1571989-7](#) [B123J77V7B2](#) [B226J50W4Q22P](#) [B433J37ZQ22M](#) [160212E](#) [1801.1164](#) [1831.1102](#) [1833.3402](#) [1837.1118](#)