



# Inductors for Decoupling Circuits

Multilayer Ferrite

## MLZ<sub>series</sub>

---

<b>MLZ1005</b>	<b>1005 [0402 inch]*</b>
<b>MLZ1608</b>	<b>1608 [0603 inch]</b>
<b>MLZ2012</b>	<b>2012 [0805 inch]</b>

\* Dimensions Code JIS[EIA]

---

## REMINDERS FOR USING THESE PRODUCTS

Before using these products, be sure to request the delivery specifications.

### SAFETY REMINDERS

Please pay sufficient attention to the warnings for safe designing when using these products.

#### REMINDERS

- The storage period is less than 12 months. Be sure to follow the storage conditions (Temperature: 5 to 40°C, Humidity: 10 to 75% RH or less).  
If the storage period elapses, the soldering of the terminal electrodes may deteriorate.
- Do not use or store in locations where there are conditions such as gas corrosion (salt, acid, alkali, etc.).
- Before soldering, be sure to preheat components.  
The preheating temperature should be set so that the temperature difference between the solder temperature and chip temperature does not exceed 150°C.
- Soldering corrections after mounting should be within the range of the conditions determined in the specifications.  
If overheated, a short circuit, performance deterioration, or lifespan shortening may occur.
- When embedding a printed circuit board where a chip is mounted to a set, be sure that residual stress is not given to the chip due to the overall distortion of the printed circuit board and partial distortion such as at screw tightening portions.
- Self heating (temperature increase) occurs when the power is turned ON, so the tolerance should be sufficient for the set thermal design.
- Carefully lay out the coil for the circuit board design of the non-magnetic shield type.  
A malfunction may occur due to magnetic interference.
- Use a wrist band to discharge static electricity in your body through the grounding wire.
- Do not expose the products to magnets or magnetic fields.
- Do not use for a purpose outside of the contents regulated in the delivery specifications.
- The products listed on this catalog are intended for use in general electronic equipment (AV equipment, telecommunications equipment, home appliances, amusement equipment, computer equipment, personal equipment, office equipment, measurement equipment, industrial robots) under a normal operation and use condition.  
The products are not designed or warranted to meet the requirements of the applications listed below, whose performance and/or quality require a more stringent level of safety or reliability, or whose failure, malfunction or trouble could cause serious damage to society, person or property.  
If you intend to use the products in the applications listed below or if you have special requirements exceeding the range or conditions set forth in the each catalog, please contact us.

- (1) Aerospace/Aviation equipment
- (2) Transportation equipment (cars, electric trains, ships, etc.)
- (3) Medical equipment
- (4) Power-generation control equipment
- (5) Atomic energy-related equipment
- (6) Seabed equipment
- (7) Transportation control equipment

- (8) Public information-processing equipment
- (9) Military equipment
- (10) Electric heating apparatus, burning equipment
- (11) Disaster prevention/crime prevention equipment
- (12) Safety equipment
- (13) Other applications that are not considered general-purpose applications

When designing your equipment even for general-purpose applications, you are kindly requested to take into consideration securing protection circuit/device or providing backup circuits in your equipment.

# Inductors for Decoupling Circuits

## Multilayer Ferrite

Product compatible with RoHS directive  
Halogen-free  
Compatible with lead-free solders

# Overview of the MLZ Series

## FEATURES

- The MLZ Series include inductors for decoupling circuits that have top-class DC superimposition characteristics and low DC resistance.
- Sizes range from 1005 to 2012, and they are compatible with wide frequency band noise, from low to high frequency.
- H type products have a rated current that is equivalent to that of wound coils.
- W type products are the new standard type products that have both large current and low resistance.
- L type products have a resistance up to 60% lower than W type products.

## APPLICATION

Smart phones, tablet terminals, laptop computers, various modules such as camera modules, DSCs, video games, portable memory audio devices, navigation systems, PNDs, WLANs, SSDs

## PART NUMBER CONSTRUCTION

MLZ	1005	M	R10	W	T	000		
Series name	LxWxH Dimensions (mm)	Product internal code	Inductance (μH)		Characteristic type		Packaging style	Internal code
1005	1.0x0.5x0.5	A	R10	0.1	H	Ultra-large current type	T Taping	000
1608	1.6x0.8x0.8	D	1R0	1	D	High frequency type		
2012	2.0x1.25x0.85	M	100	10	W	Large current type		
2012	2.0x1.25x1.25	N			L	Low resistance type		
		P						

## OPERATING TEMPERATURE RANGE, PACKAGE QUANTITY, PRODUCT WEIGHT

Type	Temperature range		Package quantity (pieces/reel)	Individual weight (mg)
	Operating temperature*	Storage temperature**		
	(°C)	(°C)		
MLZ1005	-55 to +125	-55 to +125	10000	1.2
MLZ1608	-55 to +125	-55 to +125	4000	4
MLZ2012	t=0.85	-55 to +125	2000	10
	t=1.25			14

\* Operating temperature range includes self-temperature rise.

\*\* The Storage temperature is for after the circuit board is mounted.

- RoHS Directive Compliant Product: See the following for more details related to RoHS Directive compliant products. <http://product.tdk.com/en/environment/rohs/>
- Halogen-free: Indicates that Cl content is less than 900ppm, Br content is less than 900ppm, and that the total Cl and Br content is less than 1500ppm.

• All specifications are subject to change without notice.

# Overview of the MLZ Series

## RECOMMENDED REFLOW PROFILE



Preheating			Soldering		Peak	
Temp.	Temp.	Time	Temp.	Time	Temp.	Time
T1	T2	t1	T3	t2	T4	t3
150°C	180°C	60 to 120s	230°C	30 to 60s	250 to 260°C	10s max.

MLZ series

# MLZ1005 Type



## ■ SHAPE & DIMENSIONS

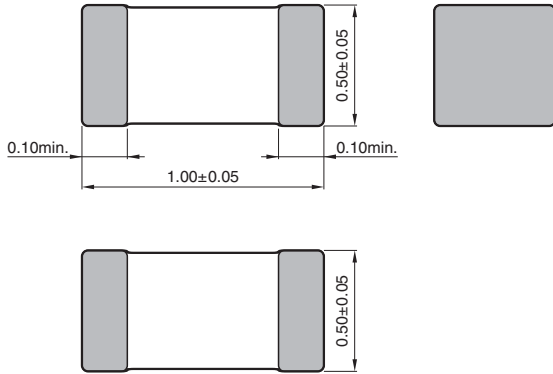

Dimensions in mm

## ■ RECOMMENDED LAND PATTERN

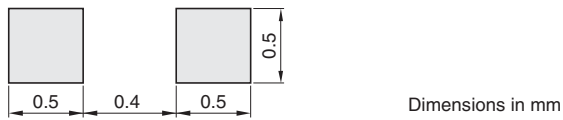

Dimensions in mm

• All specifications are subject to change without notice.

MLZ series **MLZ1005 Type**

## ■ ELECTRICAL CHARACTERISTICS

## □ CHARACTERISTICS SPECIFICATION TABLE

Type	L		L measuring conditions		DC resistance ( $\Omega$ ) $\pm$ 30%	Rated current* <sup>1</sup> (mA)	Rated current* <sup>2</sup> (mA)	Part No.
	( $\mu$ H)	Tolerance	Frequency (MHz)	Current (mA)				
Large current	0.47	$\pm$ 20%	2	0.1	0.20	120	500	MLZ1005MR47WT000
	0.68	$\pm$ 20%	2	0.1	0.30	110	450	MLZ1005MR68WT000
	1.00	$\pm$ 20%	2	0.1	0.35	100	450	MLZ1005M1R0WT000
	1.50	$\pm$ 20%	2	0.1	0.50	80	350	MLZ1005M1R5WT000
	2.20	$\pm$ 20%	2	0.1	0.55	60	350	MLZ1005M2R2WT000

\*<sup>1</sup> Current assumed when inductance ratio has decreased by 50% max..

\*<sup>2</sup> Current assumed when temperature has risen to 20°C max. (reference value).  
Operating temperature environment at this time: 105°C max.

## ○ Measurement equipment

Measurement item	Product No.	Manufacturer
L	4294A+16034G	Agilent Technologies
DC resistance	Type-7561	Yokogawa

\* Equivalent measurement equipment may be used.

# MLZ series **MLZ1005 Type**

## ■ ELECTRICAL CHARACTERISTICS

### □ L FREQUENCY CHARACTERISTICS GRAPH

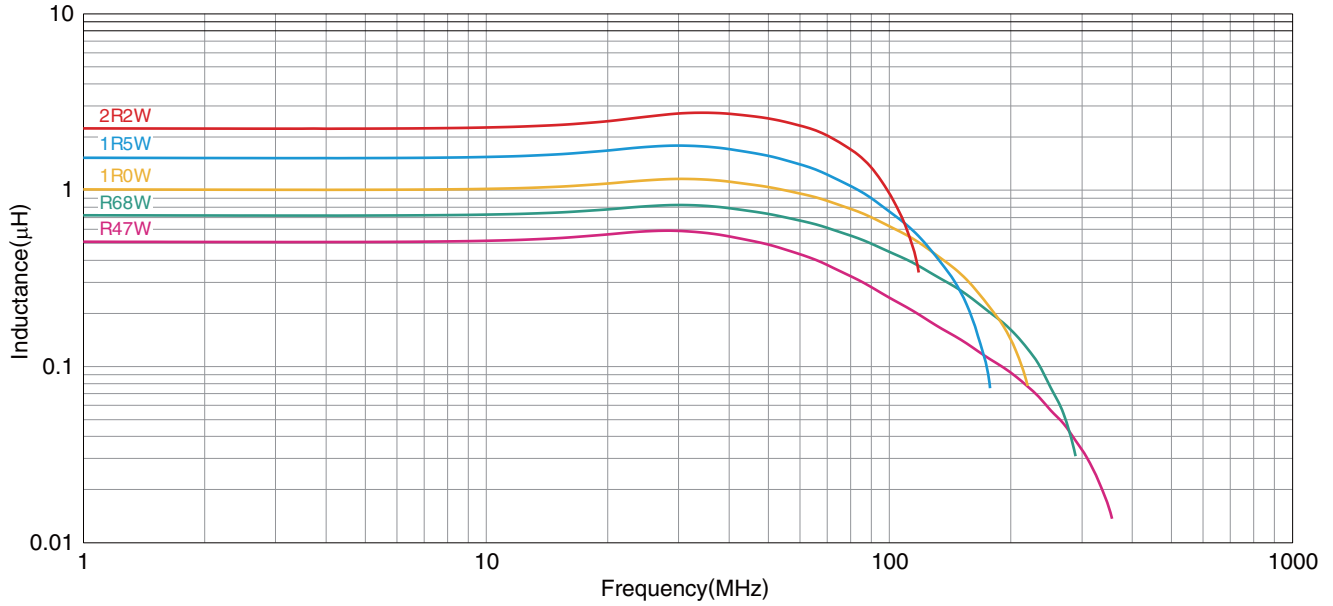

○ Measurement equipment

Product No.	Manufacturer
E4991A+16192A	Agilent Technologies

\* Equivalent measurement equipment may be used.

# MLZ series MLZ1005 Type

## ELECTRICAL CHARACTERISTICS

### INDUCTANCE VS. DC BIAS CHARACTERISTICS GRAPH

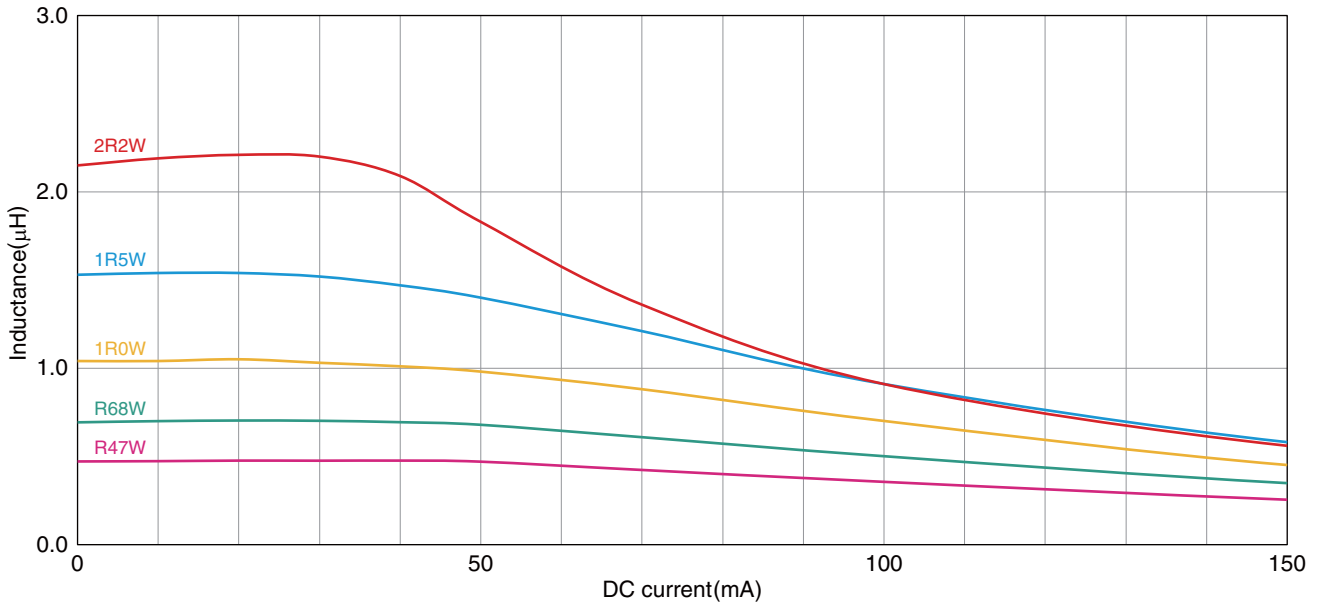

○ Measurement equipment

Product No.	Manufacturer
4291B+16200A+16192A	Agilent Technologies

\* Equivalent measurement equipment may be used.



# MLZ series MLZ1005 Type

## ■ ELECTRICAL CHARACTERISTICS

### □ IMPEDANCE FREQUENCY CHARACTERISTICS GRAPH

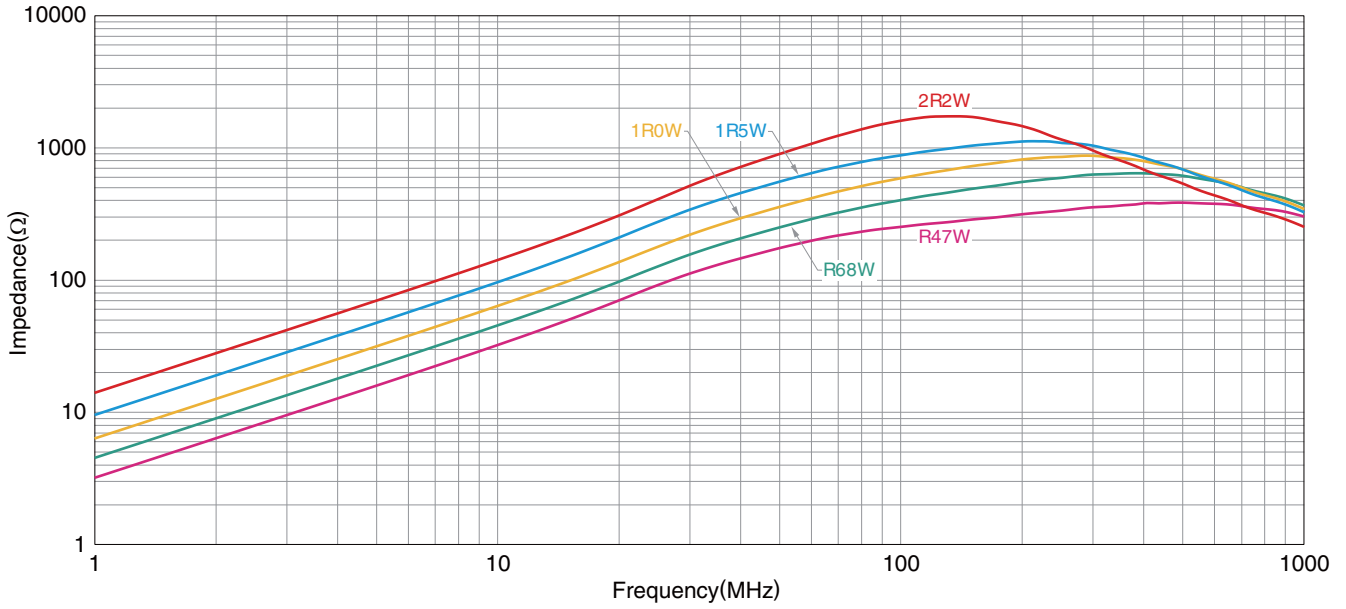

○ Measurement equipment

Product No.	Manufacturer
E4991A+16192A	Agilent Technologies

\* Equivalent measurement equipment may be used.

• All specifications are subject to change without notice.

MLZ series

# MLZ1608 Type



## ■ SHAPE & DIMENSIONS

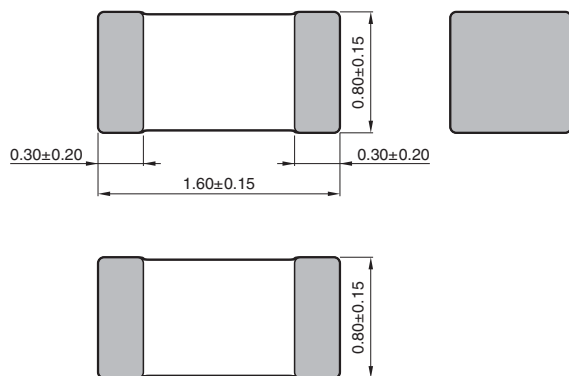

Dimensions in mm

## ■ RECOMMENDED LAND PATTERN

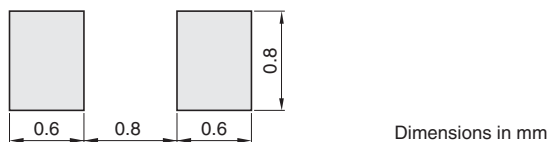

Dimensions in mm

• All specifications are subject to change without notice.

# MLZ series MLZ1608 Type

## ■ ELECTRICAL CHARACTERISTICS

### □ CHARACTERISTICS SPECIFICATION TABLE

Type	L		L measuring conditions		DC resistance ( $\Omega$ ) $\pm$ 30%	Rated current* <sup>1</sup> (mA)	Rated current* <sup>2</sup> (mA)	Part No.
	( $\mu$ H)	Tolerance	Frequency (MHz)	Current (mA)				
High frequency	0.10	$\pm$ 20%	25	1.0	0.14	700	850	MLZ1608DR10DT000
	0.22	$\pm$ 20%	25	1.0	0.27	550	600	MLZ1608DR22DT000
	0.47	$\pm$ 20%	25	1.0	0.42	400	500	MLZ1608DR47DT000
	1.00	$\pm$ 20%	10	1.0	0.15	190	600	MLZ1608A1R0WT000
Large current	2.20	$\pm$ 20%	10	1.0	0.25	130	500	MLZ1608A2R2WT000
	4.70	$\pm$ 20%	2	0.1	0.50	120	350	MLZ1608M4R7WT000
	10.0	$\pm$ 20%	2	0.1	1.05	90	250	MLZ1608M100WT000
	22.0	$\pm$ 20%	2	0.1	2.40	55	150	MLZ1608M220WT000
	1.00	$\pm$ 20%	2	0.1	0.11	140	700	MLZ1608N1R0LT000
Low resistance	2.20	$\pm$ 20%	2	0.1	0.18	110	500	MLZ1608N2R2LT000
	4.70	$\pm$ 20%	2	0.1	0.32	80	400	MLZ1608N4R7LT000
	10.0	$\pm$ 20%	2	0.1	0.60	60	300	MLZ1608N100LT000
	22.0	$\pm$ 20%	2	0.1	1.65	50	190	MLZ1608N220LT000

\*1 Current assumed when inductance ratio has decreased by 50% max..

\*2 Current assumed when temperature has risen to 20°C max. (reference value).  
Operating temperature environment at this time: 105°C max.

#### ○ Measurement equipment

Measurement item	Product No.	Manufacturer
L	4294A+16034G	Agilent Technologies
DC resistance	Type-7561	Yokogawa

\* Equivalent measurement equipment may be used.

# MLZ series MLZ1608 Type

## ELECTRICAL CHARACTERISTICS

### FREQUENCY CHARACTERISTICS GRAPH

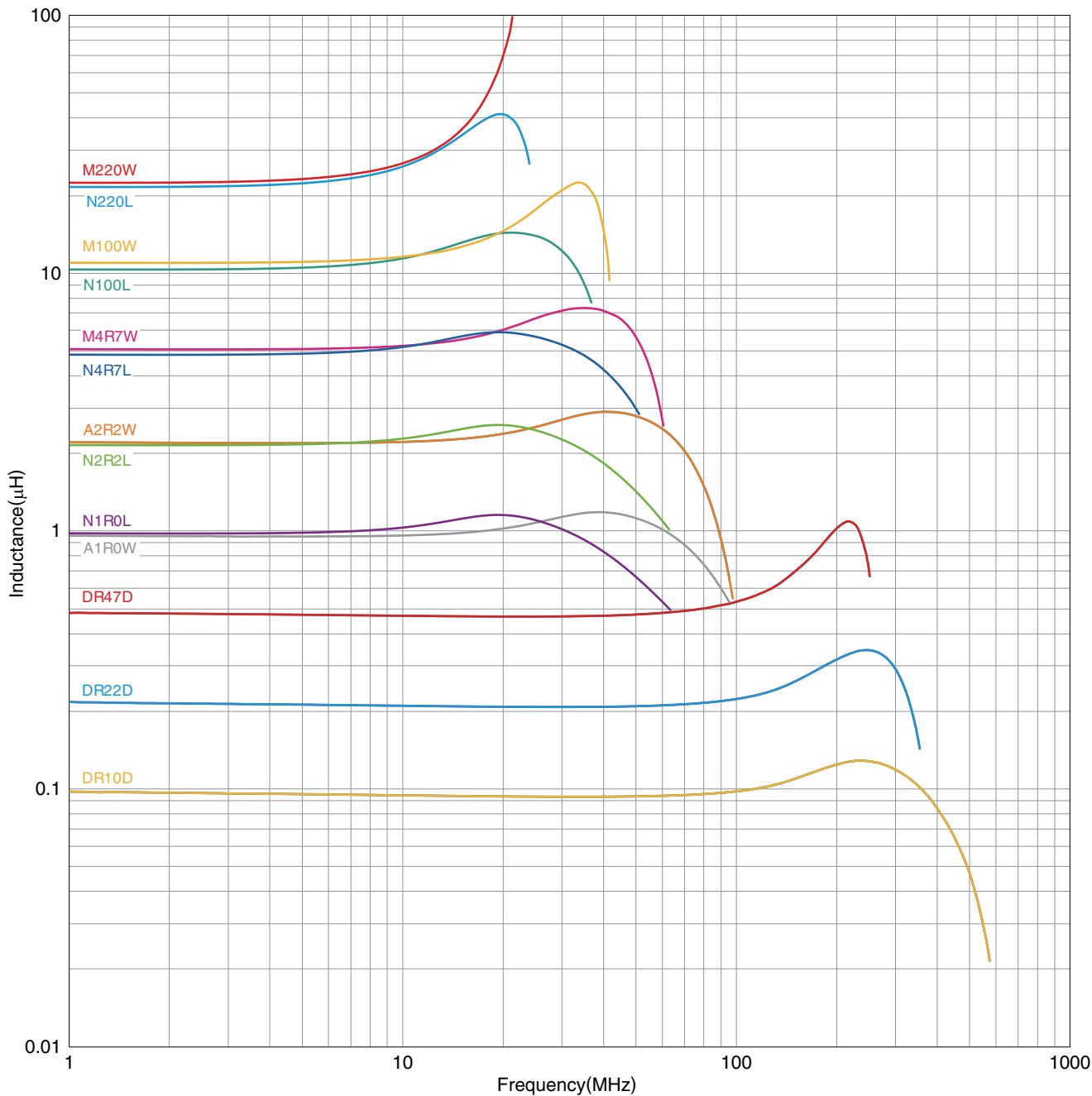

○ Measurement equipment

Product No.	Manufacturer
E4991A+16192A	Agilent Technologies

\* Equivalent measurement equipment may be used.

• All specifications are subject to change without notice.

# MLZ series MLZ1608 Type

## ELECTRICAL CHARACTERISTICS

### INDUCTANCE VS. DC BIAS CHARACTERISTICS GRAPH

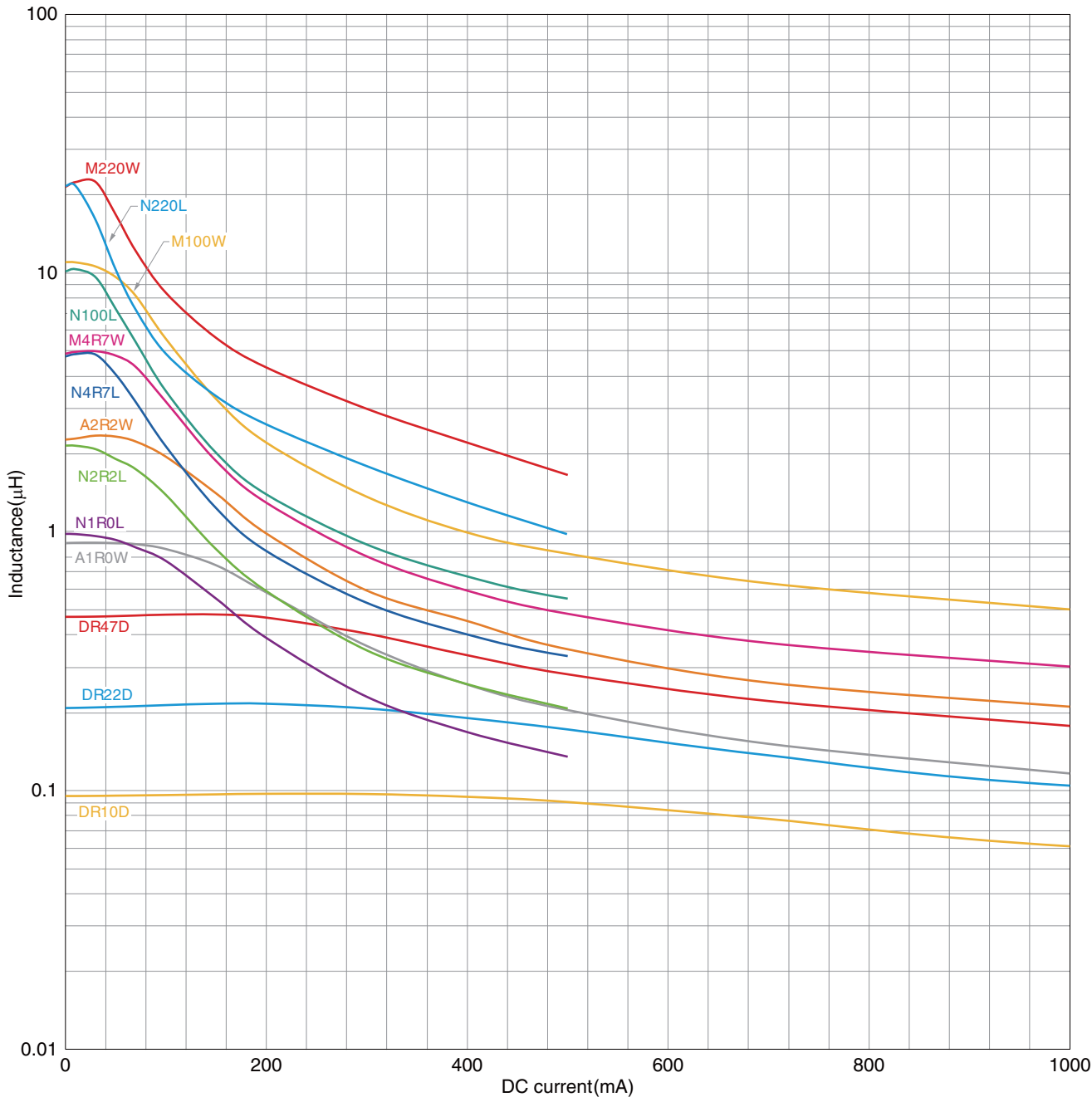

○ Measurement equipment

Product No.	Manufacturer
4291B+16200A+16192A	Agilent Technologies

\* Equivalent measurement equipment may be used.

• All specifications are subject to change without notice.

# MLZ series **MLZ1608 Type**

## ■ ELECTRICAL CHARACTERISTICS

### □ IMPEDANCE FREQUENCY CHARACTERISTICS GRAPH

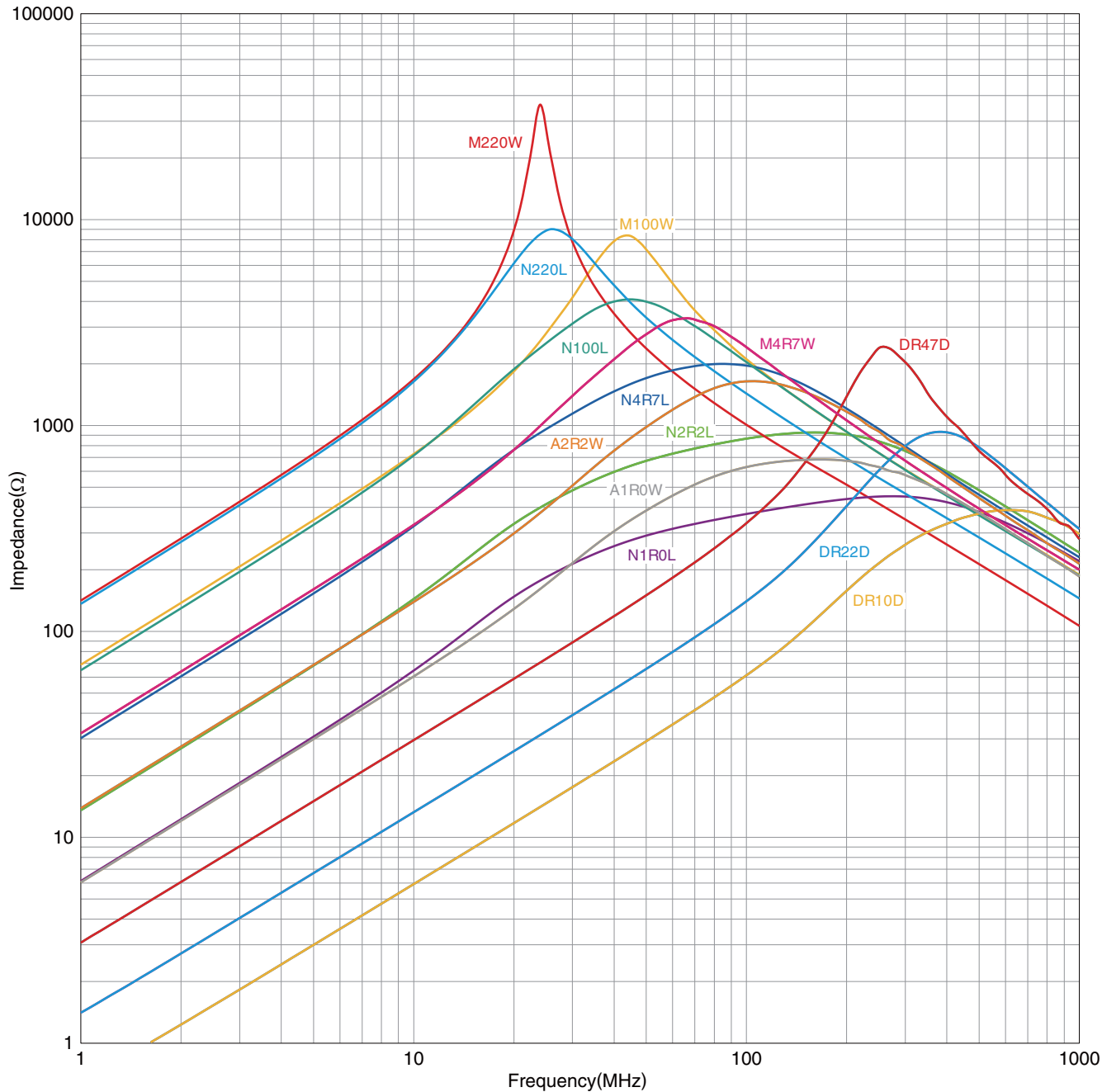

○ Measurement equipment

Product No.	Manufacturer
E4991A+16192A	Agilent Technologies

\* Equivalent measurement equipment may be used.

• All specifications are subject to change without notice.

MLZ series

# MLZ2012 Type



## ■ SHAPE & DIMENSIONS

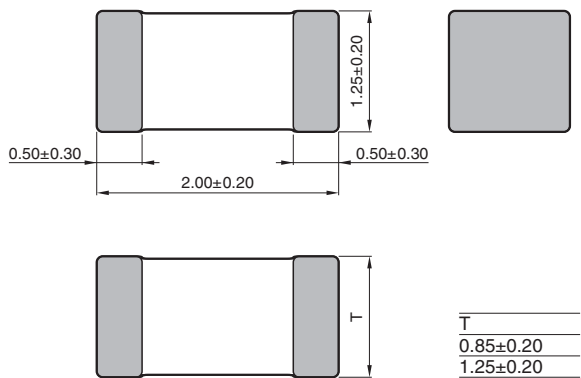

## ■ RECOMMENDED LAND PATTERN

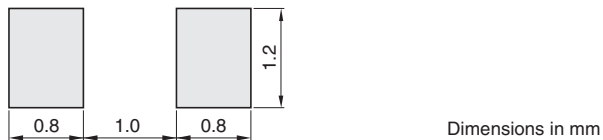

• All specifications are subject to change without notice.

MLZ series **MLZ2012 Type**

## ■ ELECTRICAL CHARACTERISTICS

## □ CHARACTERISTICS SPECIFICATION TABLE

Type	L		Thickness T (mm)	L measuring conditions		DC resistance ( $\Omega$ ) $\pm$ 30%	Rated current* <sup>1</sup> (mA)	Rated current* <sup>2</sup> (mA)	Part No.
	( $\mu$ H)	Tolerance		Frequency (MHz)	Current (mA)				
Ultra-large current	1.0	$\pm$ 20%	1.25	2	0.1	0.10	700	800	MLZ2012M1R0HT000
	1.5	$\pm$ 20%	1.25	2	0.1	0.14	550	700	MLZ2012M1R5HT000
	2.2	$\pm$ 20%	1.25	2	0.1	0.16	400	600	MLZ2012M2R2HT000
	3.3	$\pm$ 20%	1.25	2	0.1	0.20	350	500	MLZ2012M3R3HT000
	4.7	$\pm$ 20%	1.25	2	0.1	0.34	300	400	MLZ2012M4R7HT000
	6.8	$\pm$ 20%	1.25	2	0.1	0.40	220	350	MLZ2012M6R8HT000
High frequency	10	$\pm$ 20%	1.25	2	0.1	0.68	200	300	MLZ2012M100HT000
	0.10	$\pm$ 20%	0.85	25	1.0	0.07	1000	1150	MLZ2012DR10DT000
	0.22	$\pm$ 20%	0.85	25	1.0	0.13	800	900	MLZ2012DR22DT000
Large current	0.47	$\pm$ 20%	1.25	25	1.0	0.18	550	700	MLZ2012DR47DT000
	1.00	$\pm$ 20%	0.85	10	1.0	0.10	280	900	MLZ2012A1R0WT000
	1.50	$\pm$ 20%	0.85	10	1.0	0.13	250	750	MLZ2012A1R5WT000
	2.20	$\pm$ 20%	0.85	10	1.0	0.15	210	650	MLZ2012A2R2WT000
	3.30	$\pm$ 20%	0.85	10	1.0	0.34	200	450	MLZ2012A3R3WT000
	4.70	$\pm$ 20%	0.85	2	0.1	0.30	180	500	MLZ2012M4R7WT000
	6.80	$\pm$ 20%	1.25	2	0.1	0.40	160	400	MLZ2012M6R8WT000
	10.0	$\pm$ 20%	1.25	2	0.1	0.47	150	350	MLZ2012M100WT000
	15.0	$\pm$ 20%	1.25	2	0.1	0.95	120	250	MLZ2012M150WT000
	22.0	$\pm$ 20%	1.25	2	0.1	1.25	100	220	MLZ2012P220WT000
	22.0	$\pm$ 20%	1.25	2	0.1	2.0	60	220	MLZ2012M220WT000
	33.0	$\pm$ 20%	1.25	2	0.1	2.60	55	190	MLZ2012M330WT000
47.0	$\pm$ 20%	1.25	2	0.1	3.70	50	170	MLZ2012M470WT000	
Low resistance	1.00	$\pm$ 20%	0.85	2	0.1	0.06	220	1150	MLZ2012N1R0LT000
	1.50	$\pm$ 20%	0.85	2	0.1	0.10	190	900	MLZ2012N1R5LT000
	2.20	$\pm$ 20%	0.85	2	0.1	0.12	170	800	MLZ2012N2R2LT000
	3.30	$\pm$ 20%	0.85	2	0.1	0.15	130	750	MLZ2012N3R3LT000
	4.70	$\pm$ 20%	0.85	2	0.1	0.18	130	600	MLZ2012N4R7LT000
	6.80	$\pm$ 20%	0.85	2	0.1	0.25	110	550	MLZ2012N6R8LT000
	10.0	$\pm$ 20%	1.25	2	0.1	0.30	110	500	MLZ2012N100LT000
	15.0	$\pm$ 20%	1.25	2	0.1	0.47	90	350	MLZ2012N150LT000
	22.0	$\pm$ 20%	1.25	2	0.1	0.67	70	300	MLZ2012N220LT000
100.0	$\pm$ 20%	1.25	2	0.1	3.50	30	140	MLZ2012N101LT000	

\*1 Current assumed when inductance ratio has decreased by 50% max..

\*2 Current assumed when temperature has risen to 20°C max. (reference value).

Operating temperature environment at this time: 105°C max.

## ○ Measurement equipment

Measurement item	Product No.	Manufacturer
L	4294A+16034G	Agilent Technologies
DC resistance	Type-7561	Yokogawa

\* Equivalent measurement equipment may be used.



# MLZ series MLZ2012 Type

## ELECTRICAL CHARACTERISTICS

### L FREQUENCY CHARACTERISTICS GRAPH H CHARACTERISTIC PRODUCT

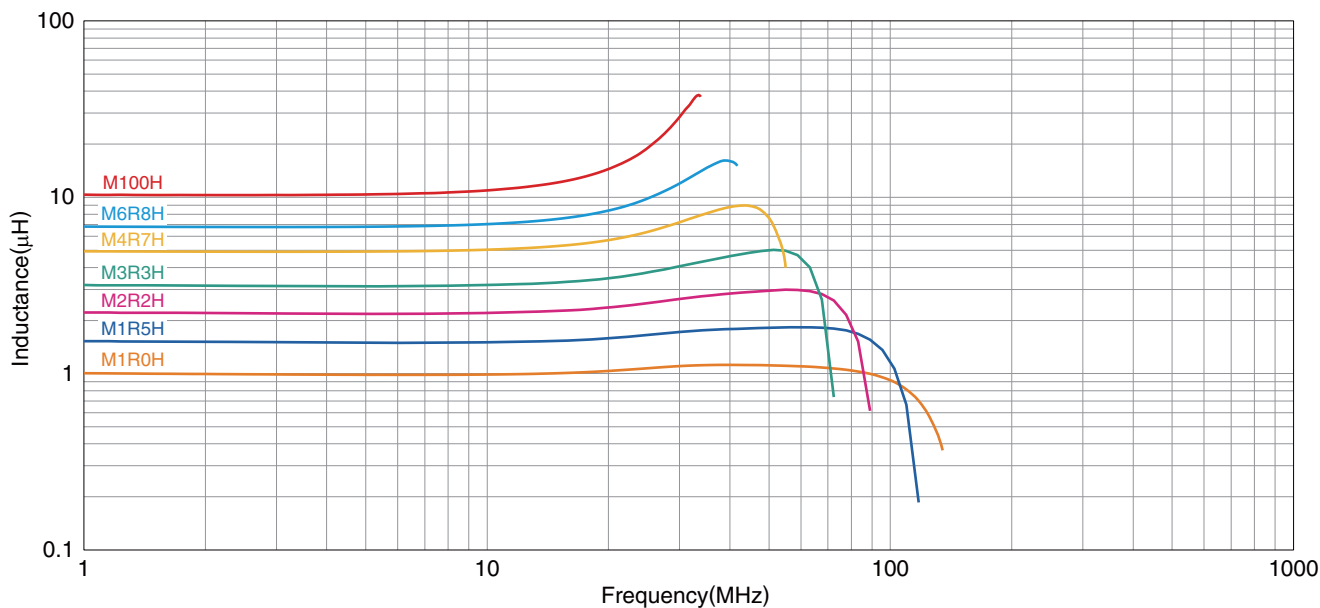

○ Measurement equipment

Product No.	Manufacturer
E4991A+16192A	Agilent Technologies

\* Equivalent measurement equipment may be used.

### L FREQUENCY CHARACTERISTICS GRAPH D CHARACTERISTIC PRODUCT

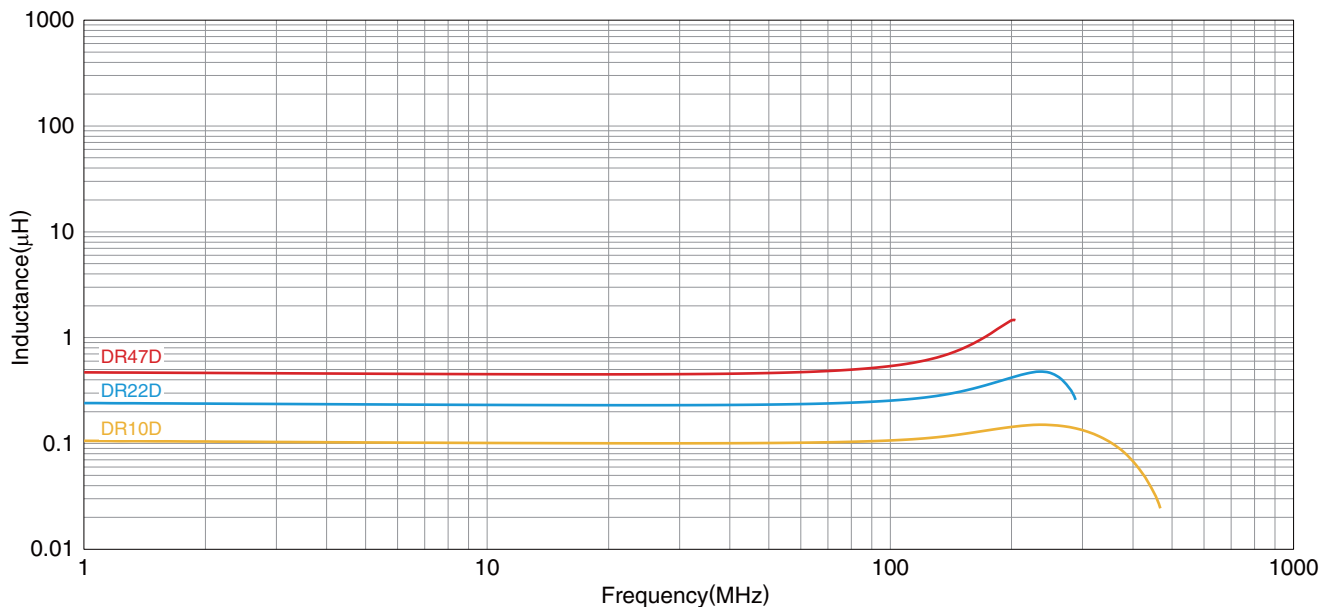

○ Measurement equipment

Product No.	Manufacturer
E4991A+16192A	Agilent Technologies

\* Equivalent measurement equipment may be used.

• All specifications are subject to change without notice.

# MLZ series MLZ2012 Type

## ELECTRICAL CHARACTERISTICS

### L FREQUENCY CHARACTERISTICS GRAPH W CHARACTERISTIC PRODUCT

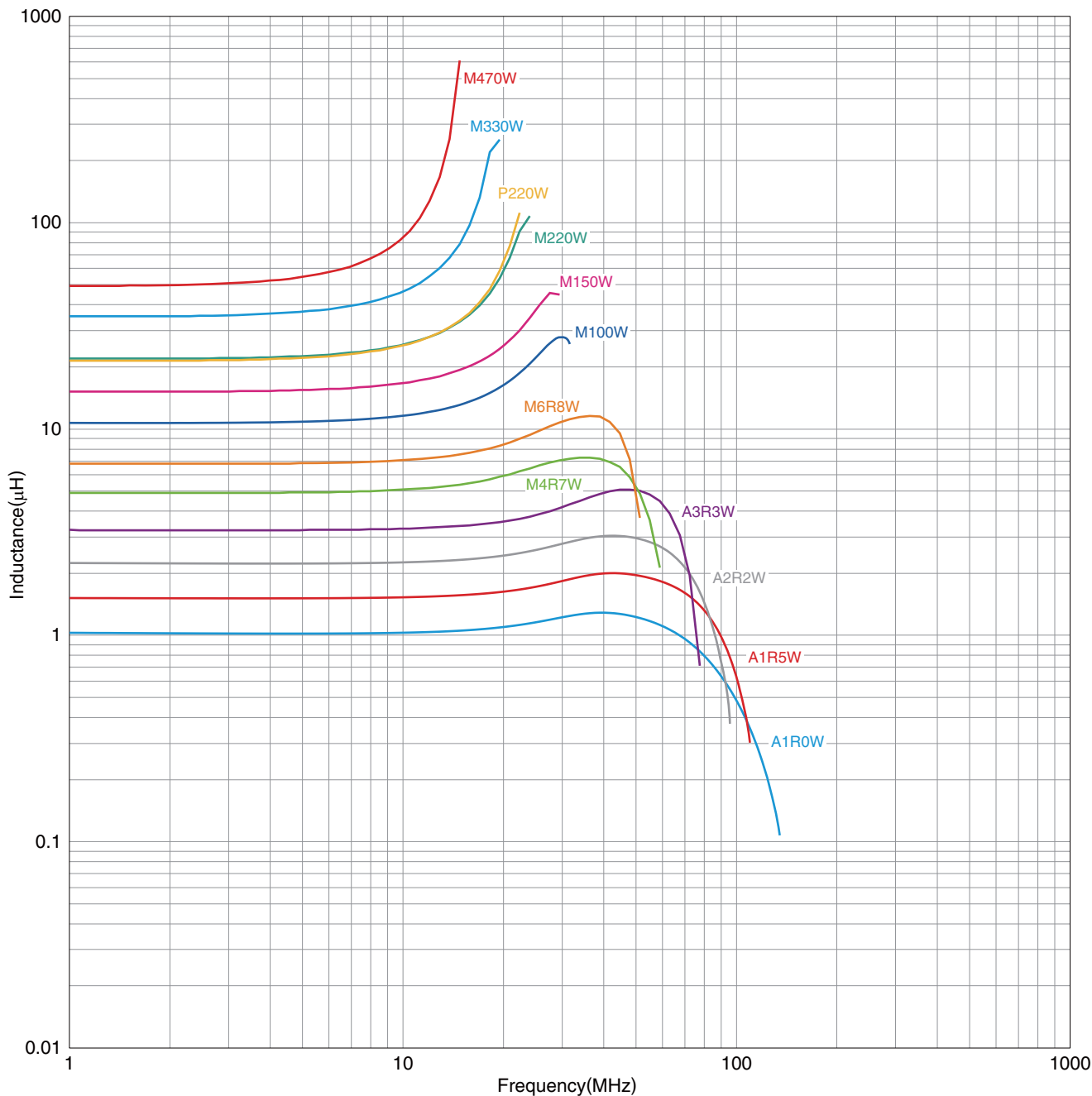

○ Measurement equipment

Product No.	Manufacturer
E4991A+16192A	Agilent Technologies

\* Equivalent measurement equipment may be used.

• All specifications are subject to change without notice.

# MLZ series MLZ2012 Type

## ELECTRICAL CHARACTERISTICS

### L FREQUENCY CHARACTERISTICS GRAPH L CHARACTERISTIC PRODUCT

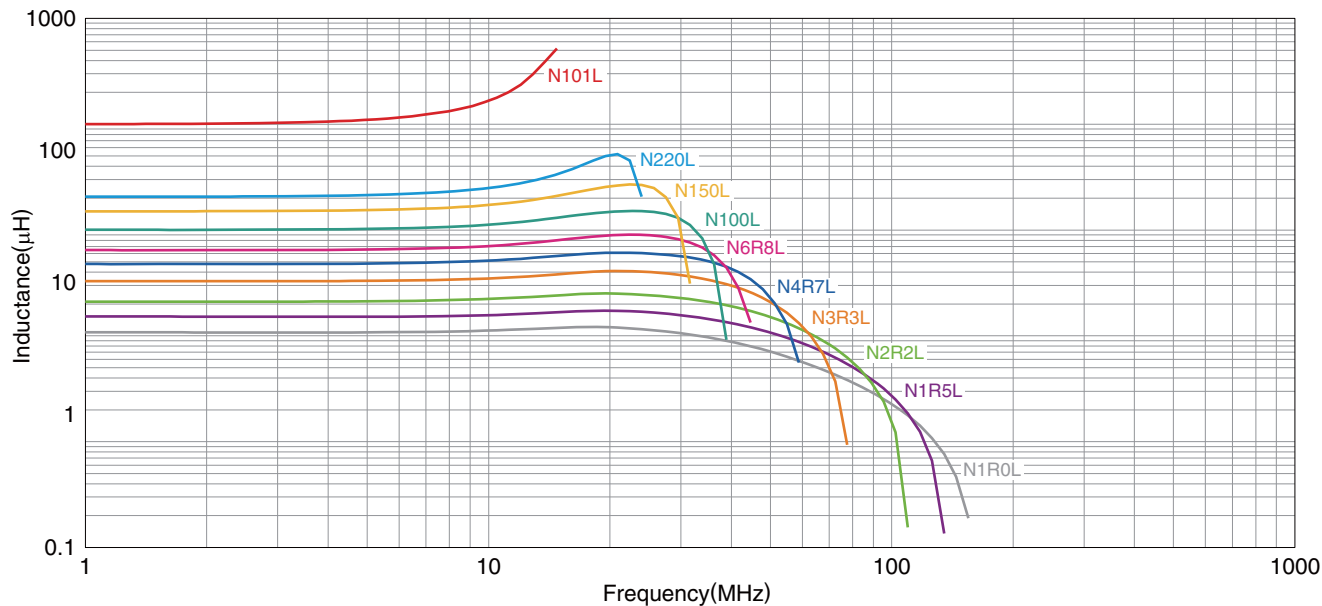

○ Measurement equipment

Product No.	Manufacturer
E4991A+16192A	Agilent Technologies

\* Equivalent measurement equipment may be used.

# MLZ series **MLZ2012 Type**

## ■ ELECTRICAL CHARACTERISTICS

### □ INDUCTANCE VS. DC BIAS CHARACTERISTICS GRAPH H CHARACTERISTIC PRODUCT

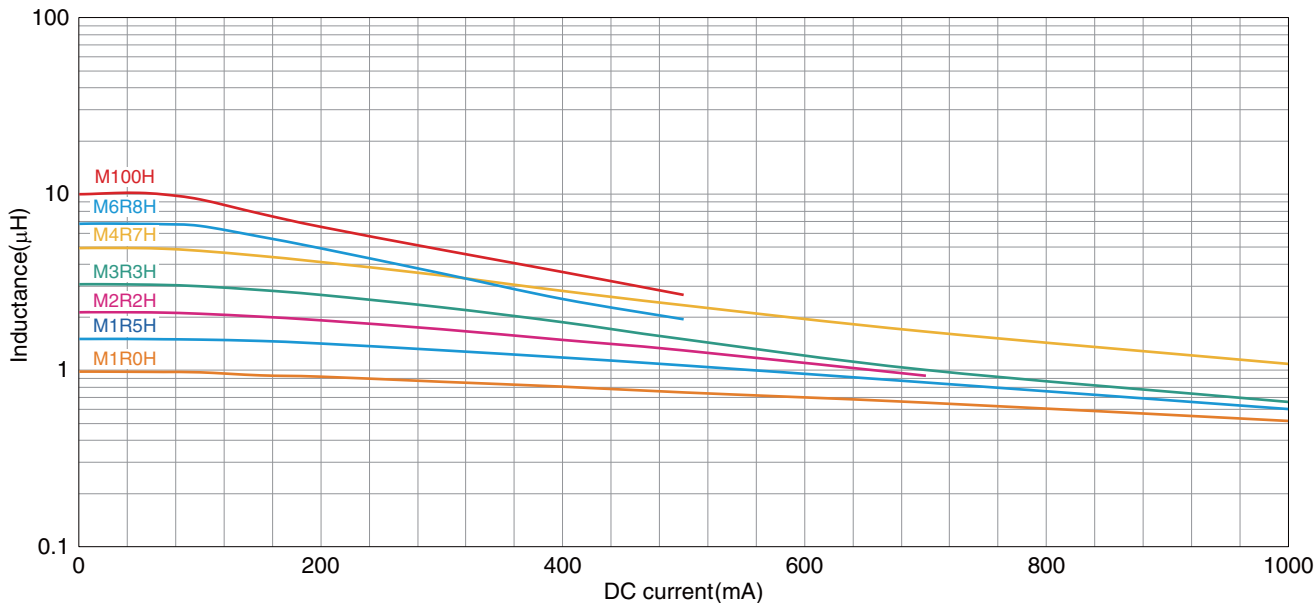

○ Measurement equipment

Product No.	Manufacturer
4291B+16200A+16192A	Agilent Technologies

\* Equivalent measurement equipment may be used.

### □ INDUCTANCE VS. DC BIAS CHARACTERISTICS GRAPH D CHARACTERISTIC PRODUCT

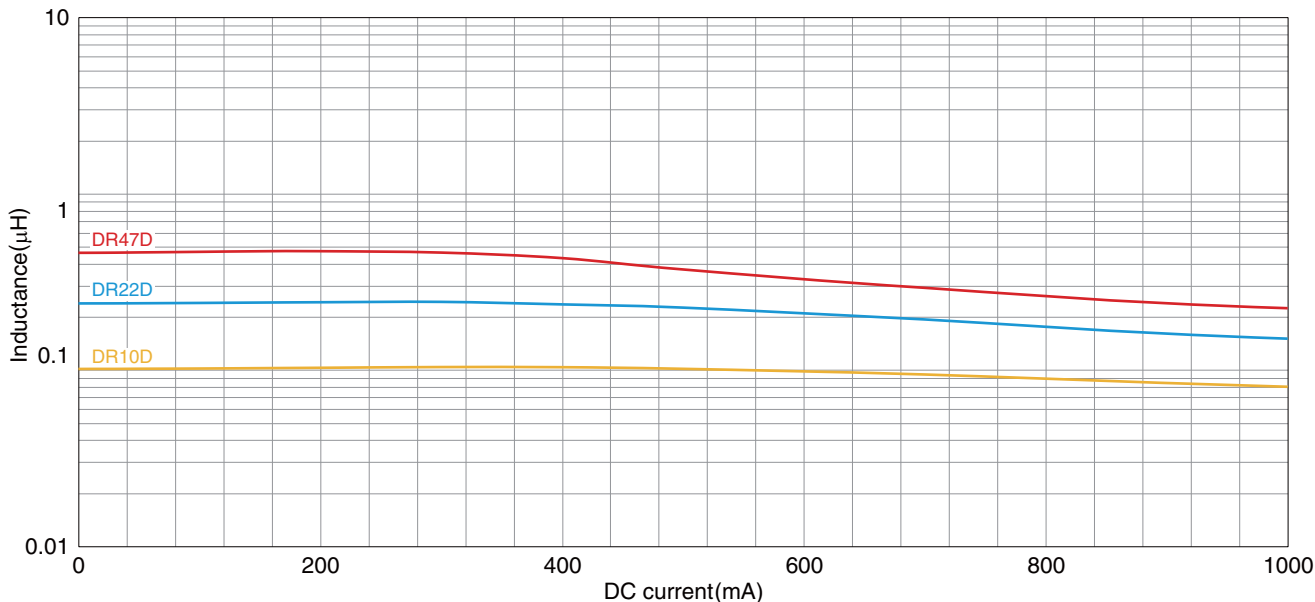

○ Measurement equipment

Product No.	Manufacturer
4291B+16200A+16192A	Agilent Technologies

\* Equivalent measurement equipment may be used.

• All specifications are subject to change without notice.

# MLZ series MLZ2012 Type

## ELECTRICAL CHARACTERISTICS

### INDUCTANCE VS. DC BIAS CHARACTERISTICS GRAPH (EXAMPLE) W CHARACTERISTIC PRODUCT

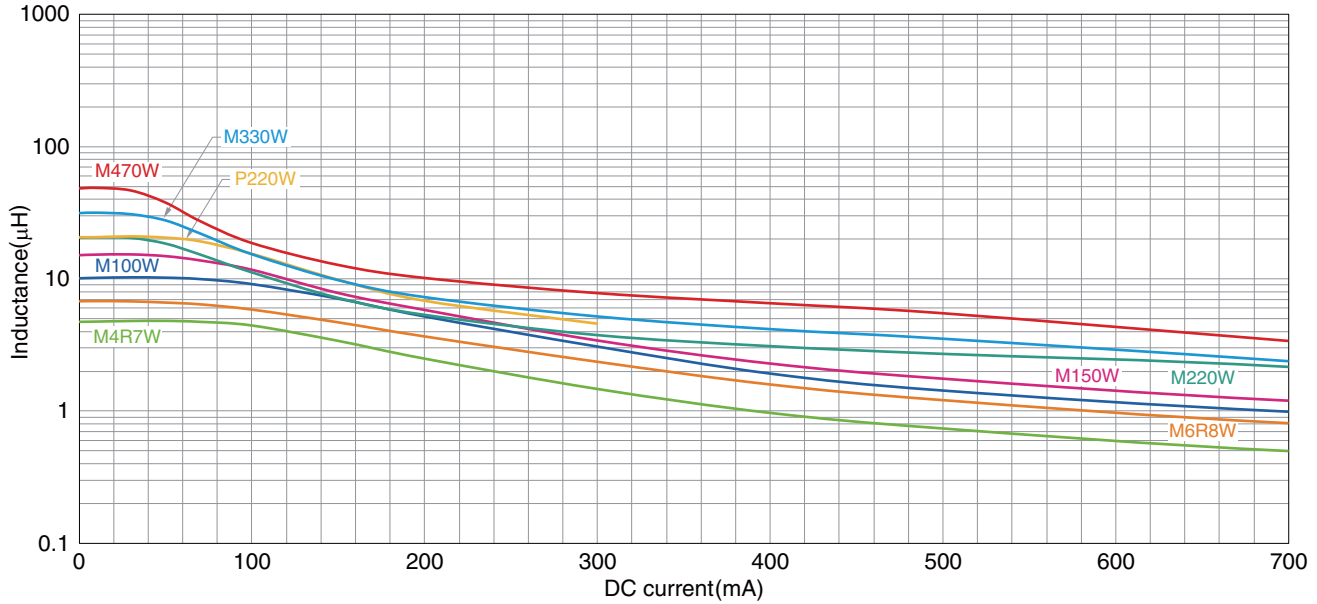

○ Measurement equipment

Product No.	Manufacturer
4291B+16200A+16192A	Agilent Technologies

\* Equivalent measurement equipment may be used.

### INDUCTANCE VS. DC BIAS CHARACTERISTICS GRAPH L CHARACTERISTIC PRODUCT

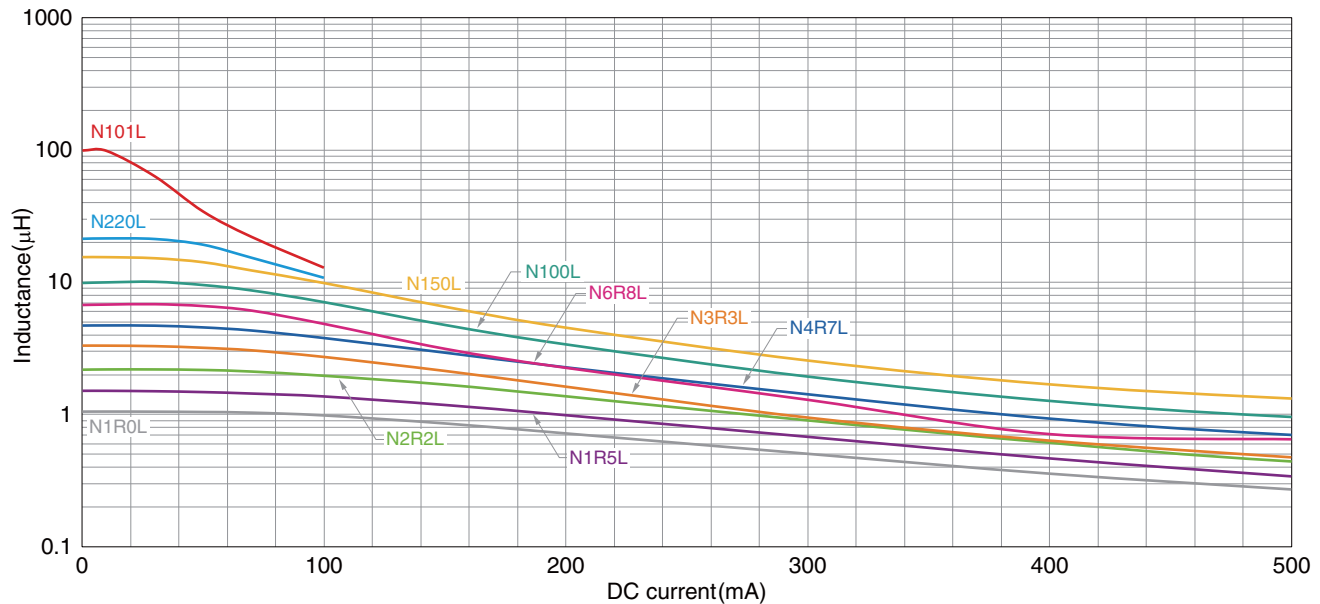

○ Measurement equipment

Product No.	Manufacturer
4291B+16200A+16192A	Agilent Technologies

\* Equivalent measurement equipment may be used.

• All specifications are subject to change without notice.

# MLZ series MLZ2012 Type

## ELECTRICAL CHARACTERISTICS

### IMPEDANCE FREQUENCY CHARACTERISTICS GRAPH H CHARACTERISTIC PRODUCT

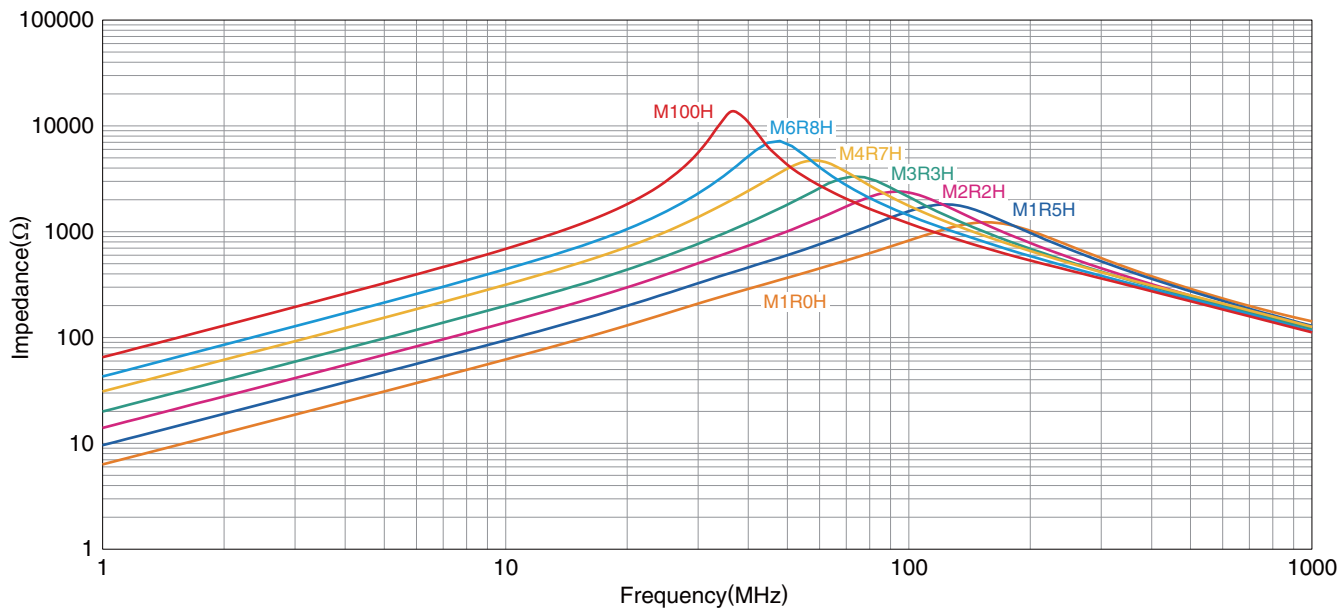

○ Measurement equipment

Product No.	Manufacturer
E4991A+16192A	Agilent Technologies

\* Equivalent measurement equipment may be used.

### IMPEDANCE FREQUENCY CHARACTERISTICS GRAPH D CHARACTERISTIC PRODUCT

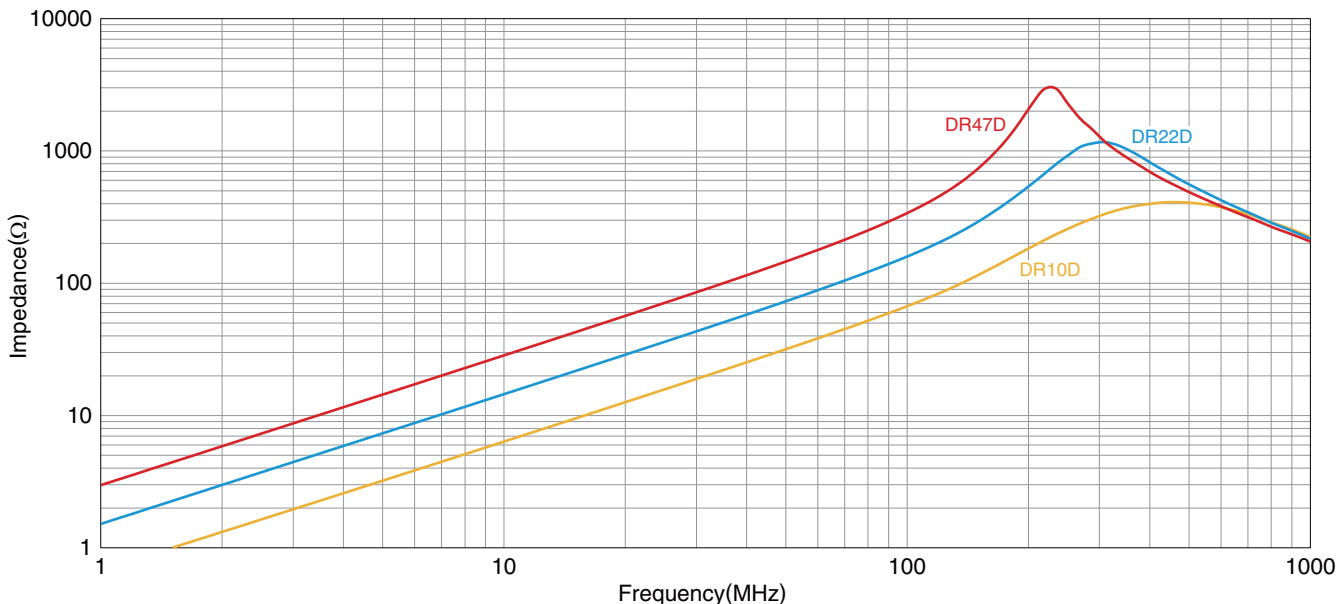

○ Measurement equipment

Product No.	Manufacturer
E4991A+16192A	Agilent Technologies

\* Equivalent measurement equipment may be used.

• All specifications are subject to change without notice.

# MLZ series **MLZ2012 Type**

## ■ ELECTRICAL CHARACTERISTICS

### □ IMPEDANCE FREQUENCY CHARACTERISTICS GRAPH W CHARACTERISTIC PRODUCT

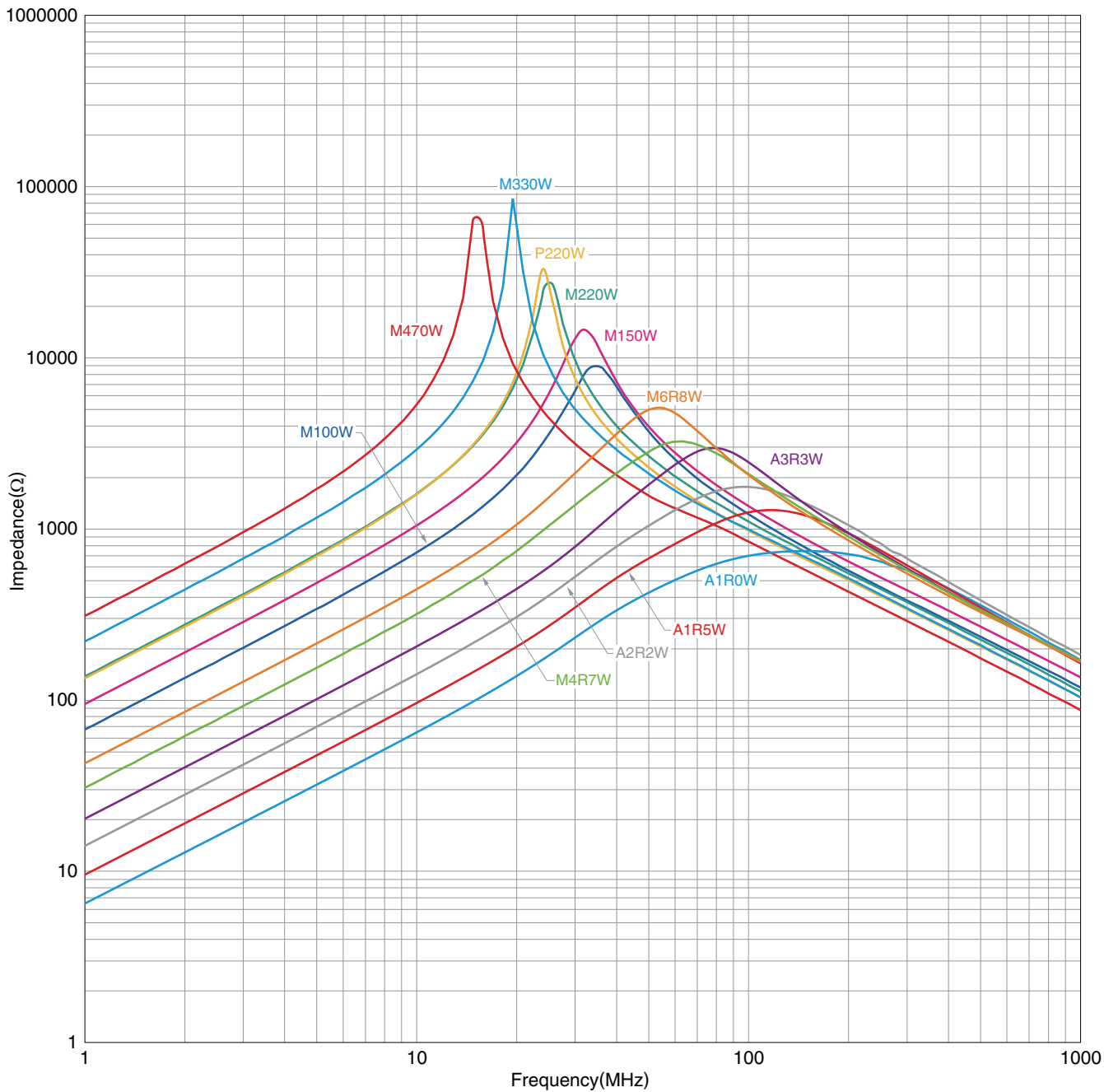

○ Measurement equipment

Product No.	Manufacturer
E4991A+16192A	Agilent Technologies

\* Equivalent measurement equipment may be used.

• All specifications are subject to change without notice.

# MLZ series MLZ2012 Type

## ELECTRICAL CHARACTERISTICS

### IMPEDANCE FREQUENCY CHARACTERISTICS GRAPH L CHARACTERISTIC PRODUCT

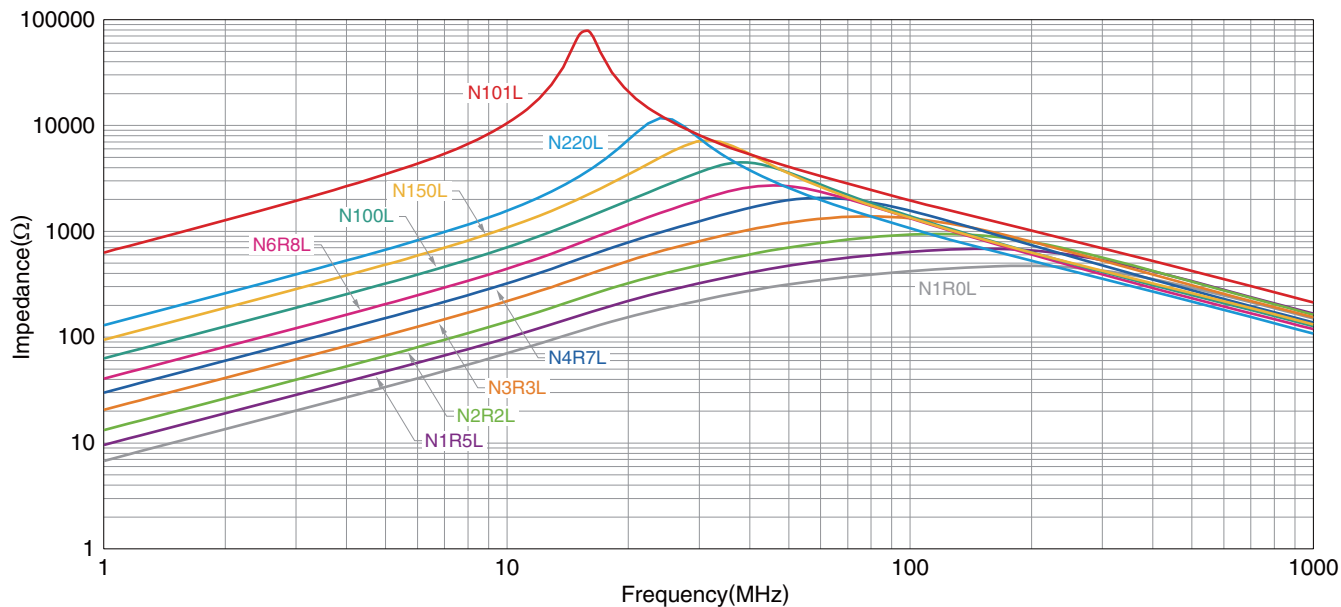

○ Measurement equipment

Product No.	Manufacturer
E4991A+16192A	Agilent Technologies

\* Equivalent measurement equipment may be used.



# MLZ series

# Packaging Style

## REEL DIMENSIONS

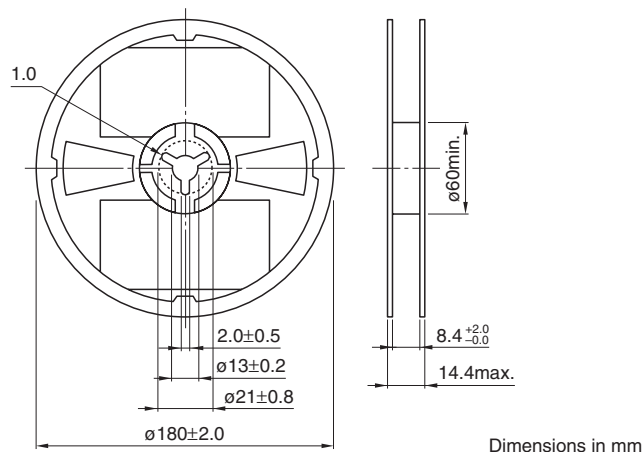

## TAPE DIMENSIONS

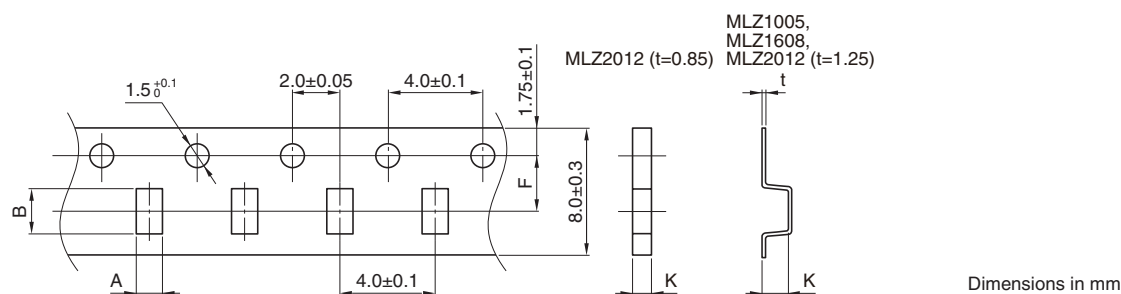

Type	A	B	K	t
MLZ1005	1.15±0.1	0.65±0.1	0.8 max.	—
MLZ1608	1.9±0.2	1.1±0.2	1.1 max.	—
MLZ2012	t=0.85	2.3±0.2	1.5±0.2	1.1 max.
	t=1.25	2.3±0.2	1.5±0.2	1.5 max.

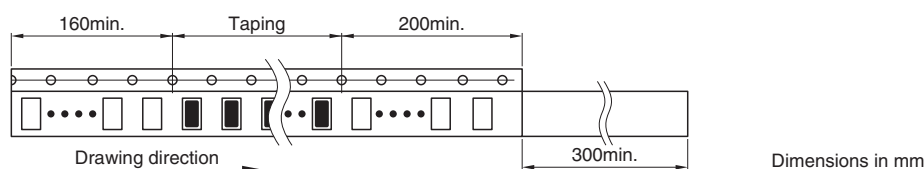

• All specifications are subject to change without notice.

## X-ON Electronics

Largest Supplier of Electrical and Electronic Components

*Click to view similar products for [Fixed Inductors](#) category:*

*Click to view products by [TDK](#) manufacturer:*

Other Similar products are found below :

[MLZ1608M6R8WTD25](#) [MLZ1608N6R8LT000](#) [MLZ1608N3R3LTD25](#) [MLZ1608N3R3LT000](#) [MLZ1608N150LT000](#)

[MLZ1608M150WTD25](#) [MLZ1608M3R3WTD25](#) [MLZ1608M3R3WT000](#) [MLZ1608M150WT000](#) [MLZ1608A1R5WT000](#)

[MLZ1608N1R5LT000](#) [B82432C1333K000](#) [PCMB053T-1R0MS](#) [PCMB053T-1R5MS](#) [PCMB104T-1R5MS](#) [CR32NP-100KC](#) [CR32NP-](#)

[151KC](#) [CR32NP-180KC](#) [CR32NP-181KC](#) [CR32NP-1R5MC](#) [CR32NP-390KC](#) [CR32NP-3R9MC](#) [CR32NP-680KC](#) [CR32NP-820KC](#)

[CR32NP-8R2MC](#) [CR43NP-390KC](#) [CR43NP-560KC](#) [CR43NP-680KC](#) [CR54NP-181KC](#) [CR54NP-470LC](#) [CR54NP-820KC](#) [CR54NP-8R5MC](#)

[MGDQ4-00004-P](#) [MGDU1-00016-P](#) [MHL1ECTTP18NJ](#) [MHL1JCTTD12NJ](#) [PE-51506NL](#) [PE-53601NL](#) [PE-53630NL](#) [PE-53824SNLT](#) [PE-](#)

[62892NL](#) [PE-92100NL](#) [PG0434.801NLT](#) [PG0936.113NLT](#) [PM06-2N7](#) [PM06-39NJ](#) [HC2LP-R47-R](#) [HC2-R47-R](#) [HC3-2R2-R](#) [HC8-1R2-R](#)