

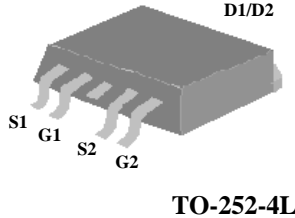

**Complementary N and P-channel
Enhancement-mode Power MOSFETs**

- Simple Drive Requirement
- Good Thermal Performance
- Fast Switching Performance
- RoHS-compliant, halogen-free



N-CH	BV_{DSS}	40V
	$R_{DS(ON)}$	28mΩ
	I_D	15A
P-CH	BV_{DSS}	-40V
	$R_{DS(ON)}$	42mΩ
	I_D	-12A

Description

Advanced Power MOSFETs from APEC provide the designer with the best combination of fast switching, low on-resistance and cost-effectiveness.

The AP4525GEH-HF-3 is in a four-lead TO-252 package, which is widely used for commercial and industrial surface-mount applications, and is well suited for applications such as DC and servo motor drives.

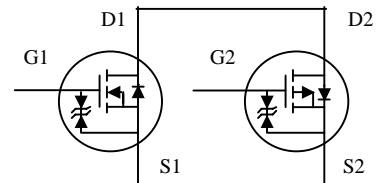

Absolute Maximum Ratings

Symbol	Parameter	Rating		Units
		N-channel	P-channel	
V_{DS}	Drain-Source Voltage	40	-40	V
V_{GS}	Gate-Source Voltage	±16	±16	V
I_D at $T_A=25^\circ\text{C}$	Continuous Drain Current ³	15.0	-12.0	A
I_D at $T_A=70^\circ\text{C}$	Continuous Drain Current ³	12.0	-10.0	A
I_{DM}	Pulsed Drain Current ¹	50	-50	A
P_D at $T_A=25^\circ\text{C}$	Total Power Dissipation	10.4		W
	Linear Derating Factor	0.083		W/°C
T_{STG}	Storage Temperature Range	-55 to 150		°C
T_J	Operating Junction Temperature Range	-55 to 150		°C

Thermal Data

Symbol	Parameter	Value	Unit
Rthj-c	Maximum Thermal Resistance, Junction-case	12	°C/W
Rthj-a	Maximum Thermal Resistance, Junction-ambient ³	40	°C/W

Ordering Information

AP4525GEH-HF-3TR RoHS-compliant TO-252-4L, shipped on tape and reel (3000 pcs/reel)
No longer recommended for new designs - use AP4543GEH-HF-3TR



N-channel Electrical Specifications at $T_j=25^\circ\text{C}$ (unless otherwise specified)

Symbol	Parameter	Test Conditions	Min.	Typ.	Max.	Units
BV_{DSS}	Drain-Source Breakdown Voltage	$V_{GS}=0V, I_D=250\mu A$	40	-	-	V
$\Delta BV_{DSS}/\Delta T_j$	Breakdown Voltage Temperature Coefficient	Reference to $25^\circ\text{C}, I_D=1\text{mA}$	-	0.03	-	$V/^\circ\text{C}$
$R_{DS(ON)}$	Static Drain-Source On-Resistance ²	$V_{GS}=10V, I_D=6A$	-	-	28	$\text{m}\Omega$
		$V_{GS}=4.5V, I_D=4A$	-	-	32	$\text{m}\Omega$
$V_{GS(th)}$	Gate Threshold Voltage	$V_{DS}=V_{GS}, I_D=250\mu A$	1	-	3	V
g_{fs}	Forward Transconductance	$V_{DS}=10V, I_D=6A$	-	6	-	S
I_{DSS}	Drain-Source Leakage Current	$V_{DS}=40V, V_{GS}=0V$	-	-	1	μA
	Drain-Source Leakage Current ($T_j=70^\circ\text{C}$)	$V_{DS}=32V, V_{GS}=0V$	-	-	25	μA
I_{GSS}	Gate-Source Leakage	$V_{GS}=\pm 16V$	-	-	± 30	μA
Q_g	Total Gate Charge ²	$I_D=6A$	-	9	14	nC
Q_{gs}	Gate-Source Charge	$V_{DS}=20V$	-	1.5	-	nC
Q_{gd}	Gate-Drain ("Miller") Charge	$V_{GS}=4.5V$	-	4	-	nC
$t_{d(on)}$	Turn-on Delay Time ²	$V_{DS}=20V$	-	7	-	ns
t_r	Rise Time	$I_D=6A$	-	20	-	ns
$t_{d(off)}$	Turn-off Delay Time	$R_G=3\Omega, V_{GS}=10V$	-	20	-	ns
t_f	Fall Time	$R_D=3.3\Omega$	-	4	-	ns
C_{iss}	Input Capacitance	$V_{GS}=0V$	-	580	930	pF
C_{oss}	Output Capacitance	$V_{DS}=25V$	-	100	-	pF
C_{rss}	Reverse Transfer Capacitance	$f=1.0\text{MHz}$	-	70	-	pF
R_g	Gate Resistance	$f=1.0\text{MHz}$	-	2	3	Ω

Source-Drain Diode

Symbol	Parameter	Test Conditions	Min.	Typ.	Max.	Units
V_{SD}	Forward On Voltage ²	$I_S=15A, V_{GS}=0V$	-	-	1.8	V
t_{rr}	Reverse Recovery Time ²	$I_S=6A, V_{GS}=0V$	-	20	-	ns
Q_{rr}	Reverse Recovery Charge	$di/dt=100A/\mu s$	-	15	-	nC

Notes:

1. Pulse width limited by maximum junction temperature.
2. Pulse width $\leq 300\mu s$, duty cycle $\leq 2\%$.
3. Values are the same for both N-CH and P-CH MOSFETs, when mounted on 2oz FR4 board, $t \leq 10s$.

THIS PRODUCT IS SENSITIVE TO ELECTROSTATIC DISCHARGE, PLEASE HANDLE WITH CAUTION.

USE OF THIS PRODUCT AS A CRITICAL COMPONENT IN LIFE SUPPORT OR OTHER SIMILAR SYSTEMS IS NOT AUTHORIZED.

APEC DOES NOT ASSUME ANY LIABILITY ARISING OUT OF THE APPLICATION OR USE OF ANY PRODUCT OR CIRCUIT DESCRIBED HEREIN; NEITHER DOES IT CONVEY ANY LICENSE UNDER ITS PATENT RIGHTS, NOR THE RIGHTS OF OTHERS.

APEC RESERVES THE RIGHT TO MAKE CHANGES WITHOUT FURTHER NOTICE TO ANY PRODUCTS HEREIN TO IMPROVE RELIABILITY, FUNCTION OR DESIGN.



P-channel Electrical Specifications at $T_j=25^\circ\text{C}$ (unless otherwise specified)

Symbol	Parameter	Test Conditions	Min.	Typ.	Max.	Units
BV_{DSS}	Drain-Source Breakdown Voltage	$V_{GS}=0V, I_D=-250\mu A$	-40	-	-	V
$\Delta BV_{DSS}/\Delta T_j$	Breakdown Voltage Temperature Coefficient	Reference to $25^\circ\text{C}, I_D=-1\text{mA}$	-	-0.03	-	$V/^\circ\text{C}$
$R_{DS(ON)}$	Static Drain-Source On-Resistance ²	$V_{GS}=-10V, I_D=-5A$	-	-	42	$\text{m}\Omega$
		$V_{GS}=-4.5V, I_D=-3A$	-	-	60	$\text{m}\Omega$
$V_{GS(th)}$	Gate Threshold Voltage	$V_{DS}=V_{GS}, I_D=-250\mu A$	-0.8	-	-2.5	V
g_{fs}	Forward Transconductance	$V_{DS}=-10V, I_D=-5A$	-	5	-	S
I_{DSS}	Drain-Source Leakage Current	$V_{DS}=-40V, V_{GS}=0V$	-	-	-1	μA
	Drain-Source Leakage Current ($T_j=70^\circ\text{C}$)	$V_{DS}=-32V, V_{GS}=0V$	-	-	-25	μA
I_{GSS}	Gate-Source Leakage	$V_{GS}=\pm 16V$	-	-	± 30	μA
Q_g	Total Gate Charge ²	$I_D=-5A$	-	9	24	nC
Q_{gs}	Gate-Source Charge	$V_{DS}=-20V$	-	2	-	nC
Q_{gd}	Gate-Drain ("Miller") Charge	$V_{GS}=-4.5V$	-	5	-	nC
$t_{d(on)}$	Turn-on Delay Time ²	$V_{DS}=-20V$	-	8.5	-	ns
t_r	Rise Time	$I_D=-5A$	-	15	-	ns
$t_{d(off)}$	Turn-off Delay Time	$R_G=3\Omega, V_{GS}=-10V$	-	27	-	ns
t_f	Fall Time	$R_D=4\Omega$	-	25	-	ns
C_{iss}	Input Capacitance	$V_{GS}=0V$	-	770	1230	pF
C_{oss}	Output Capacitance	$V_{DS}=-20V$	-	165	-	pF
C_{rss}	Reverse Transfer Capacitance	$f=1.0\text{MHz}$	-	115	-	pF
R_g	Gate Resistance	$f=1.0\text{MHz}$	-	6	9	Ω

Source-Drain Diode

Symbol	Parameter	Test Conditions	Min.	Typ.	Max.	Units
V_{SD}	Forward On Voltage ²	$I_S=-12A, V_{GS}=0V$	-	-	-1.8	V
t_{rr}	Reverse Recovery Time ²	$I_S=-5A, V_{GS}=0V$	-	20	-	ns
Q_{rr}	Reverse Recovery Charge	$di/dt=-100A/\mu s$	-	16	-	nC

Notes:

1. Pulse width limited by maximum junction temperature.
2. Pulse width $\leq 300\mu s$, duty cycle $\leq 2\%$.
3. Values are the same for both N-CH and P-CH MOSFETs, when mounted on 2oz FR4 board, $t \leq 10s$.

THIS PRODUCT IS SENSITIVE TO ELECTROSTATIC DISCHARGE, PLEASE HANDLE WITH CAUTION.

USE OF THIS PRODUCT AS A CRITICAL COMPONENT IN LIFE SUPPORT OR OTHER SIMILAR SYSTEMS IS NOT AUTHORIZED.

APEC DOES NOT ASSUME ANY LIABILITY ARISING OUT OF THE APPLICATION OR USE OF ANY PRODUCT OR CIRCUIT DESCRIBED HEREIN; NEITHER DOES IT CONVEY ANY LICENSE UNDER ITS PATENT RIGHTS, NOR THE RIGHTS OF OTHERS.

APEC RESERVES THE RIGHT TO MAKE CHANGES WITHOUT FURTHER NOTICE TO ANY PRODUCTS HEREIN TO IMPROVE RELIABILITY, FUNCTION OR DESIGN.



Typical N-channel Electrical Characteristics

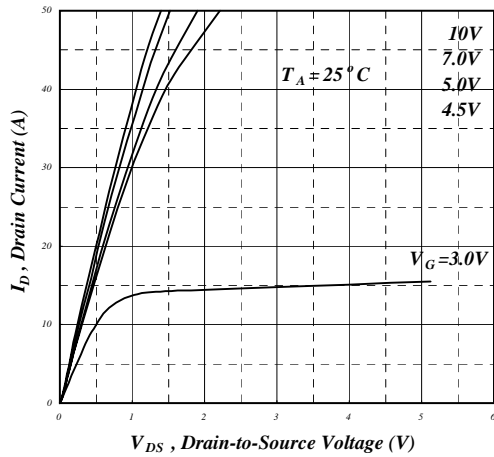

Fig 1. Typical Output Characteristics

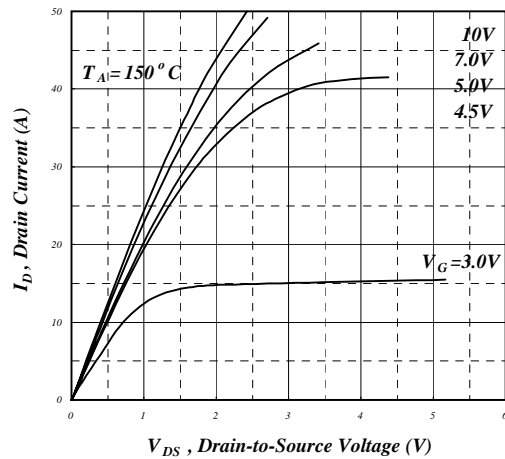

Fig 2. Typical Output Characteristics

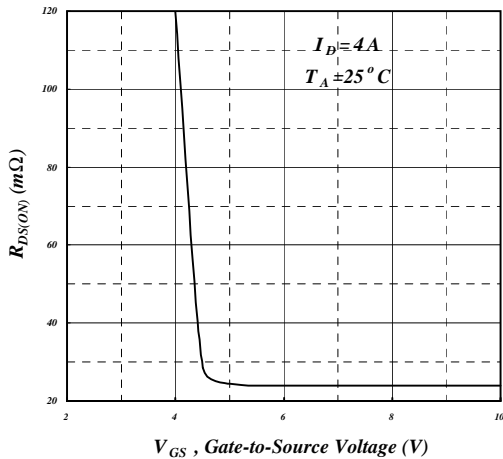

Fig 3. On-Resistance vs. Gate Voltage

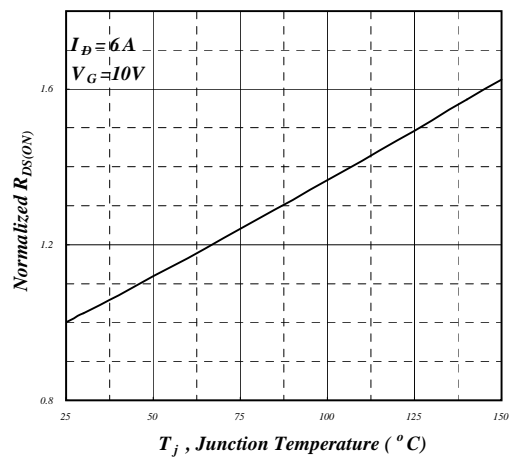

Fig 4. Normalized On-Resistance vs. Junction Temperature

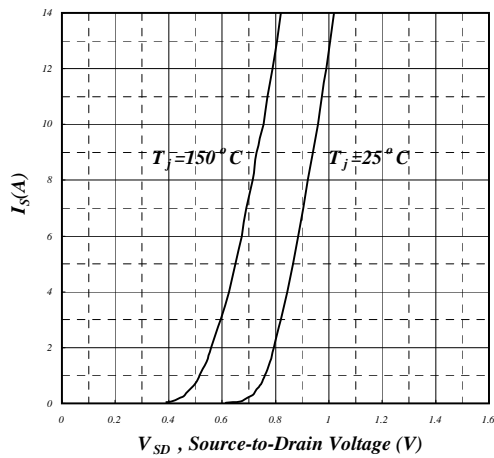

Fig 5. Forward Characteristic of Reverse Diode

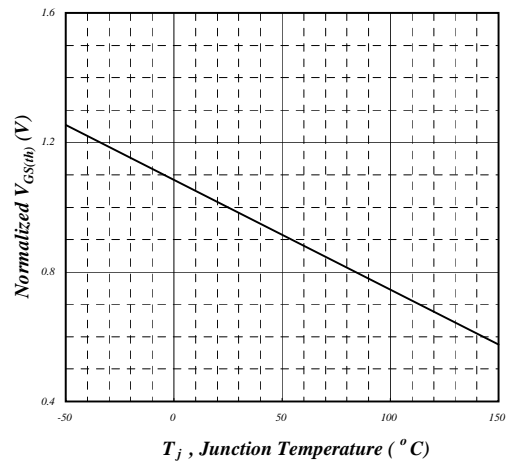

Fig 6. Gate Threshold Voltage vs. Junction Temperature



Typical N-channel Electrical Characteristics (cont.)

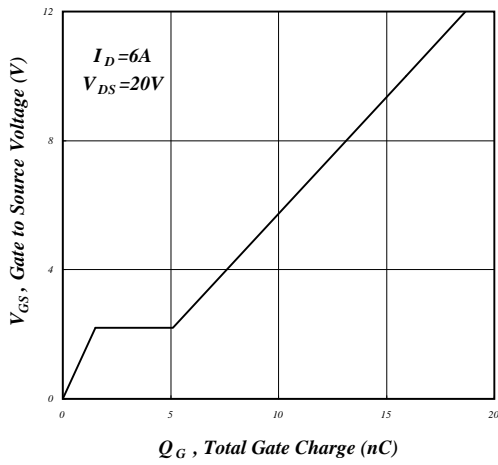

Fig 7. Gate Charge Characteristics

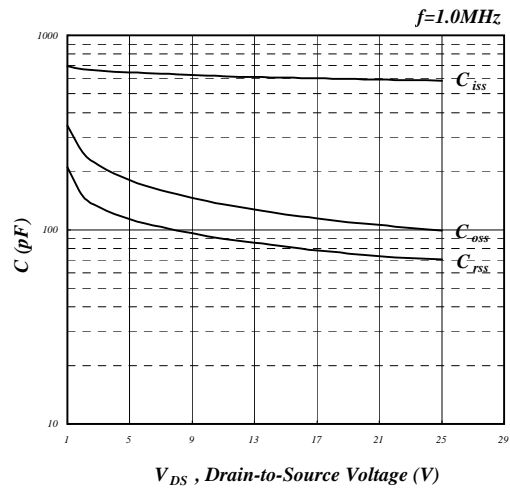

Fig 8. Typical Capacitance Characteristics

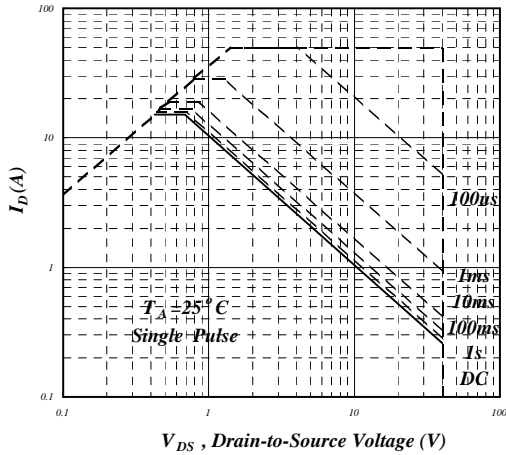

Fig 9. Maximum Safe Operating Area

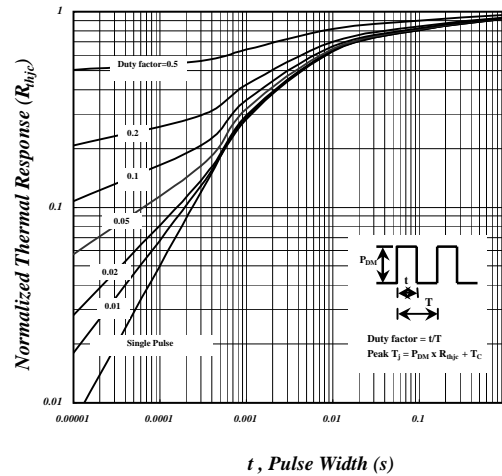

Fig 10. Effective Transient Thermal Impedance

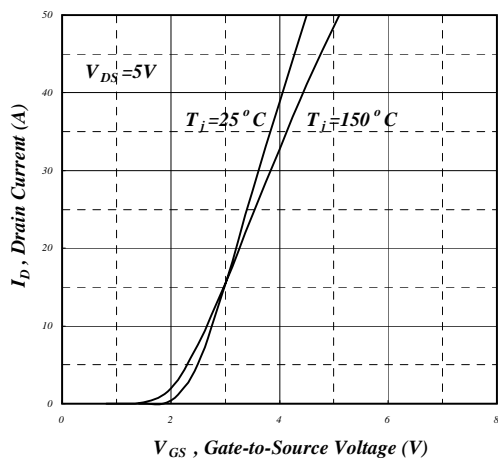

Fig 11. Transfer Characteristics

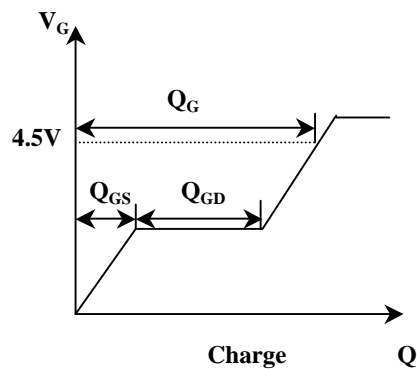

Fig 12. Gate Charge Waveform



Typical P-channel Electrical Characteristics

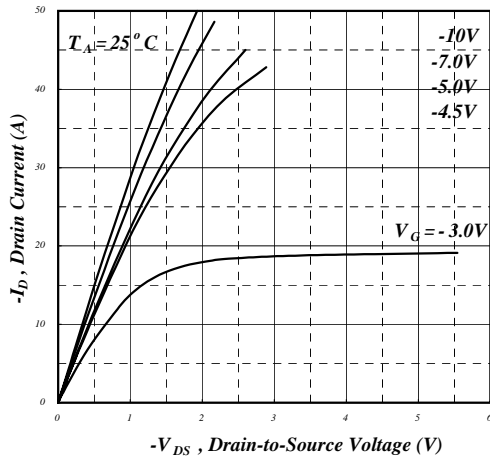

Fig 1. Typical Output Characteristics

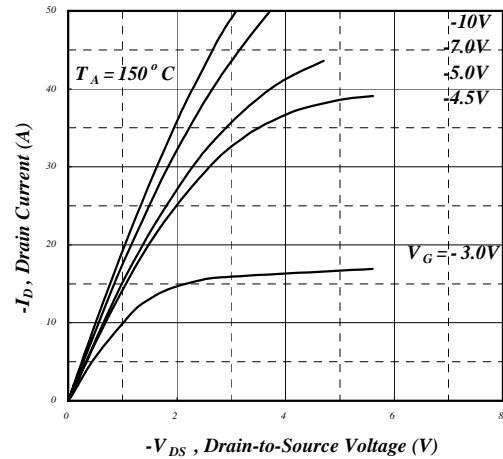

Fig 2. Typical Output Characteristics

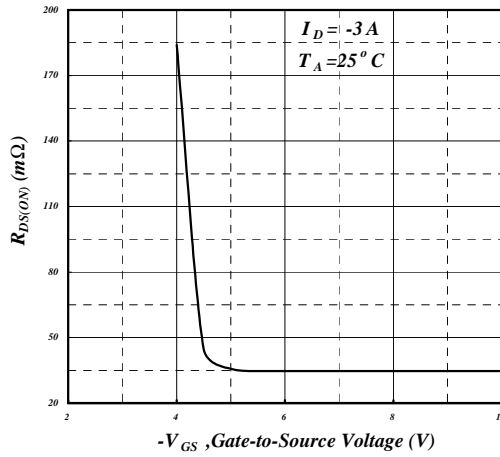

Fig 3. On-Resistance vs. Gate Voltage

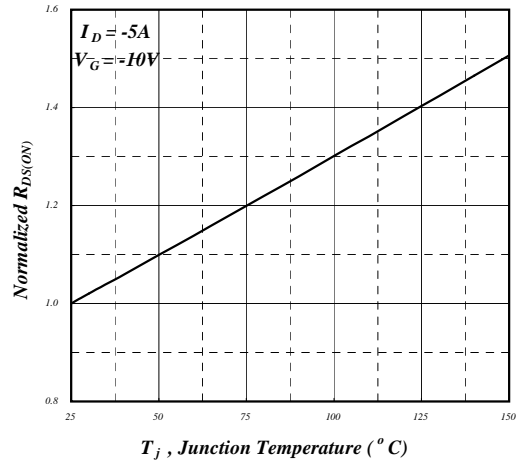

Fig 4. Normalized On-Resistance vs. Junction Temperature

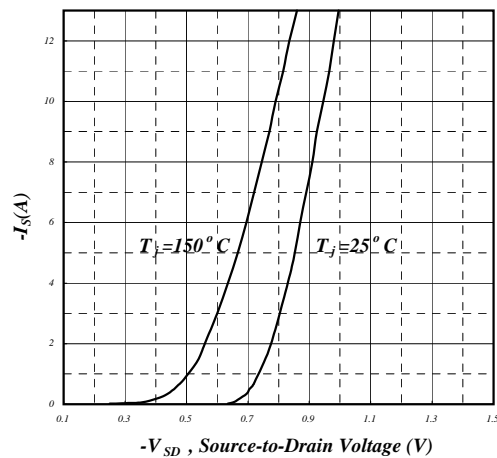

Fig 5. Forward Characteristic of Reverse Diode

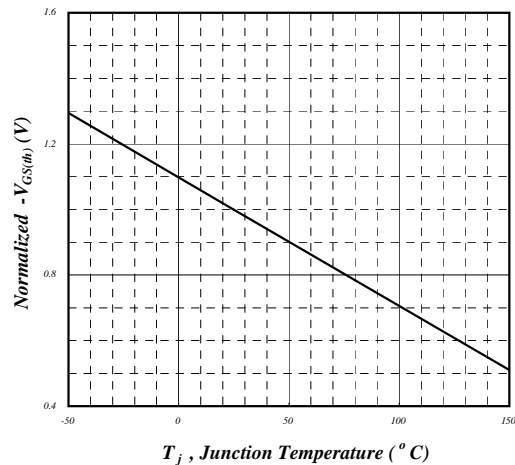

Fig 6. Gate Threshold Voltage vs. Junction Temperature



Typical P-channel Electrical Characteristics (cont.)

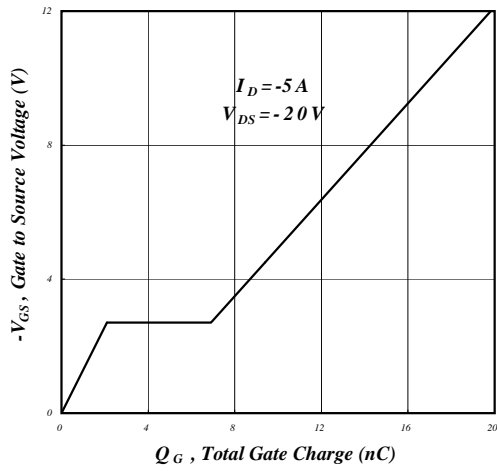

Fig 7. Gate Charge Characteristics

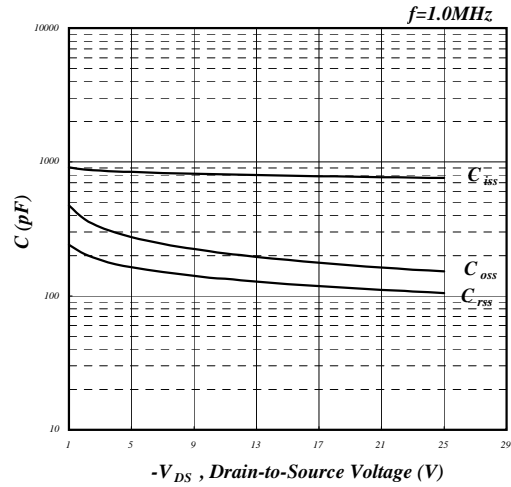

Fig 8. Typical Capacitance Characteristics

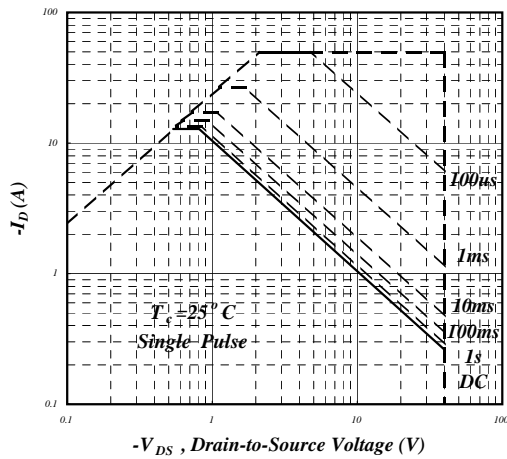

Fig 9. Maximum Safe Operating Area

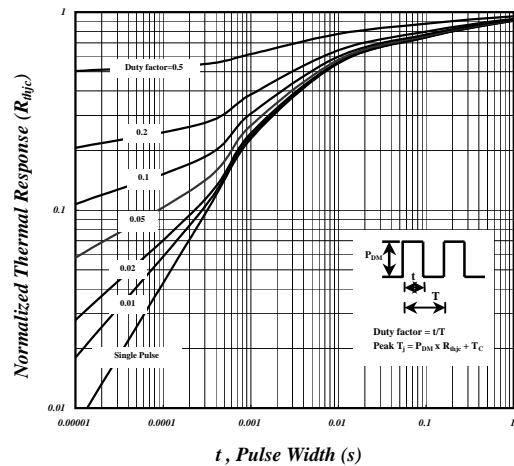

Fig 10. Effective Transient Thermal Impedance

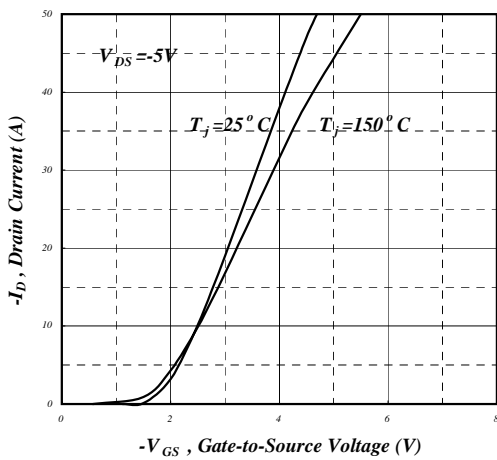

Fig 11. Transfer Characteristics

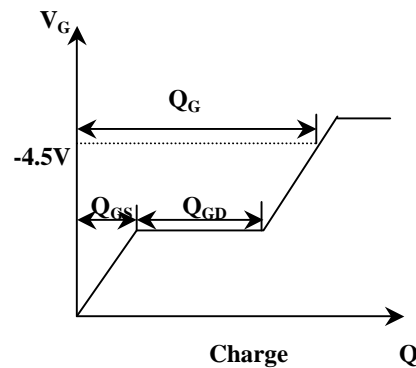
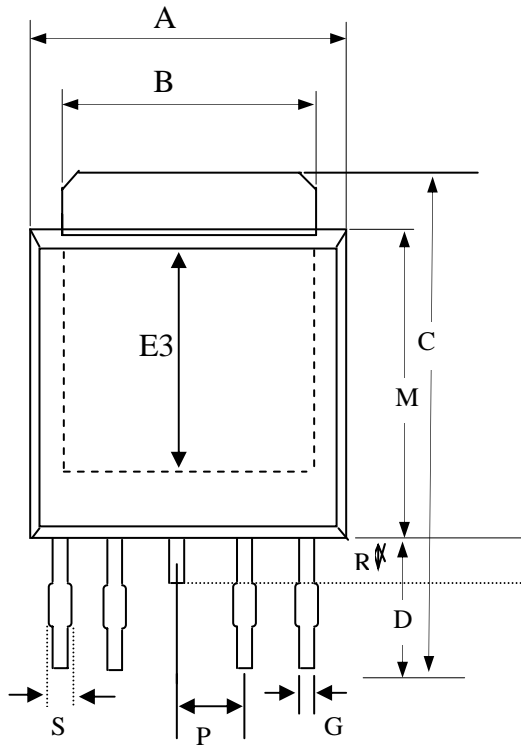

Fig 12. Gate Charge Waveform



Package Dimensions: TO-252-4L



SYMBOLS	Millimeters		
	MIN	NOM	MAX
A	6.40	6.6	6.80
B	5.2	5.35	5.50
C	9.40	9.80	10.20
D	2.40	2.70	3.00
P	1.27 REF.		
S	0.50	0.65	0.80
E3	3.50	4.00	4.50
R	0.80	1.00	1.20
G	0.40	0.50	0.60
H	2.20	2.30	2.40
J	0.45	0.50	0.55
K	0.00	0.075	0.15
L	0.90	1.20	1.50
M	5.40	5.60	5.80

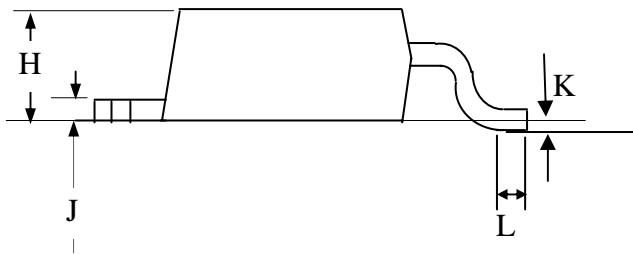

1. All dimensions are in millimeters.
2. Dimensions do not include mold protrusions.

Marking Information:

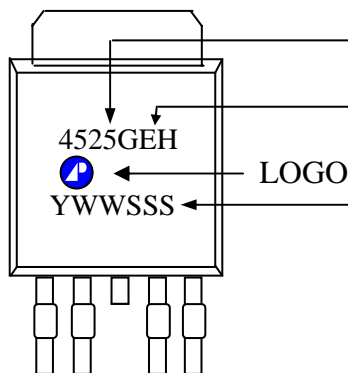

Product: AP4525

Package:

GEH = RoHS-compliant halogen-free TO-252-4L

Date/lot code (YWWSSS)

Y: Last digit of the year

WW: Work week

SSS: Lot code sequence

X-ON Electronics

Largest Supplier of Electrical and Electronic Components

Click to view similar products for [advanced power manufacturer](#):

Other Similar products are found below :

[AP50T10GH](#) [AP9923GEO-HF](#) [AP2P053N](#) [AP9575GP-HF](#) [AP10TN135N](#) [APT802R8KN](#) [AP83T03GH](#) [AP9410GH-HF](#) [AP2311GN](#)
[AP4439GM](#) [AP40N03GP](#) [AP4953GM](#) [AP9987GH](#) [AP9T18GH-HF](#) [AP09N70I-A](#) [AP8600S](#) [AP04N70BI-A](#) [AP30T10GM-HF](#) [AP9985GM-](#)
[HF](#) [AP3P050M](#) [AP9990GH-HF](#) [AP9T16AGH-HF](#) [AP4920GM](#) [AP2320GN](#) [AP4451GYT-HF](#) [AP4034GYT-HF](#) [AP65SL380DH](#)
[AP2323GN-HF](#) [AP83T03GM](#) [AP9870GH](#) [AP3P3R0MT](#) [AP2305GN-HF](#) [AP6679GH-HF](#) [AP4435GM-HF](#) [AP2306GN-HF](#)