

RoHS

Specification

SSC-SZ5P

(Rev.02_110824)

SSC		Customer
Drawn	Approval	Approval

SSC-SZ5P
August 2011

www.seoulsemicon.com

[Contents]

1. Description
2. Characteristics of Z5P
3. Characteristic diagrams
4. Outline dimensions
5. Recommended solder pad
6. Labeling
7. Reel Packing
8. Soldering profile
9. Precaution for Use

SZ5P

Description

The Z-Power series is designed for high current operation and high flux output applications.

It incorporates state of the art SMD design and low thermal resistant material. The Z Power LED is ideal light sources for general illumination applications, custom designed solutions, automotive, large backlights and high performance torches.

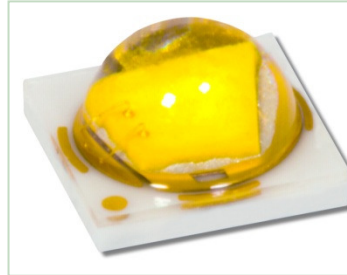

SZ5P

Features

- Super high Flux output and high Luminance
- Designed for high current operation
- SMT solderable
- Lead Free product
- RoHS compliant

Applications

- Automotive interior / exterior lighting
- Automotive signal lighting
- Automotive forward lighting
- General Torch
- Architectural lighting
- Projector light source
- Traffic signals
- Task lighting
- Decorative / Pathway lighting
- Remote / Solar powered lighting

SSC-SZ5P

August 2011

www.seoulsemicon.com

Characteristics of SZ5-P0-W0-00

Pure White

1-1 Electro-Optical characteristics at 350mA

(Ta=25℃)

Parameter	Symbol	Value			Unit
		Min	Typ	Max	
Luminous Flux [1]	Φ_V [2]	-	120	-	lm
	Φ_V (Tj=100℃)	-	115	-	
Correlated Color Temperature [3]	CCT	-	6000	-	K
CRI	R _a	-	70	-	-
Forward Voltage [4]	V _F	-	3.3	-	V
Thermal resistance (J to S)	R θ_{J-S}		6.2		K/W
View Angle	2 θ 1/2		120		deg.

1-2 Absolute Maximum Ratings

Parameter	Symbol	Value	Unit
Forward Current	I _F	1000	mA
		1000(1/10duty@1kHz)	
Reverse Voltage	V _R	5	V
Power Dissipation	P _d	4	W
Junction Temperature	T _j	145(@ I _F ≤ 1000mA)	°C
Operating Temperature	T _{opr}	-40 ~ +85	°C
Storage Temperature	T _{stg}	-40 ~ +100	°C
ESD Sensitivity [5]	-	± 8,000V HBM	-

*Notes :

- [1] SSC maintains a tolerance of ±10% on flux and power measurements.
- [2] Φ_V is the total luminous flux output as measured with an integrating sphere.
- [3] Correlated Color Temperature is derived from the CIE 1931 Chromaticity diagram.
Color coordinate : 0.005, CCT ±5% tolerance.
- [4] Tolerance is ±0.06V on forward voltage measurements
- [5] A zener diode is included to protect the product from ESD.

Characteristics of SZ5-P0-WN-00

Neutral White

1-1 Electro-Optical characteristics at 350mA

(Ta=25°C)

Parameter	Symbol	Value			Unit
		Min	Typ	Max	
Luminous Flux [1]	Φ_V [2]	-	120	-	lm
	Φ_V (Tj=100°C)	-	113	-	
Correlated Color Temperature [3]	CCT	-	4200	-	K
CRI	R _a	-	65	-	-
Forward Voltage [4]	V _F	-	3.3	-	V
Thermal resistance (J to S)	R θ_{J-S}		6.2		K/W
View Angle	2 θ 1/2		120		deg.

1-2 Absolute Maximum Ratings

Parameter	Symbol	Value	Unit
Forward Current	I _F	1000	mA
		1000(1/10duty@1kHz)	
Reverse Voltage	V _R	5	V
Power Dissipation	P _d	4	W
Junction Temperature	T _j	145(@ I _F ≤ 1000mA)	°C
Operating Temperature	T _{opr}	-40 ~ +85	°C
Storage Temperature	T _{stg}	-40 ~ +100	°C
ESD Sensitivity [5]	-	± 8,000V HBM	-

*Notes :

- [1] SSC maintains a tolerance of ±10% on flux and power measurements.
- [2] Φ_V is the total luminous flux output as measured with an integrating sphere.
- [3] Correlated Color Temperature is derived from the CIE 1931 Chromaticity diagram.
Color coordinate : 0.005, CCT ±5% tolerance.
- [4] Tolerance is ±0.06V on forward voltage measurements
- [5] A zener diode is included to protect the product from ESD.

Characteristics of SZ5-P0-WN-C8

Neutral White

1-1 Electro-Optical characteristics at 350mA

(Ta=25°C)

Parameter	Symbol	Value			Unit
		Min	Typ	Max	
Luminous Flux [1]	Φ_V [2]	-	100	-	lm
	Φ_V (Tj=100°C)	-	98	-	
Correlated Color Temperature [3]	CCT	-	4200	-	K
CRI	R _a	80	-	-	-
Forward Voltage [4]	V _F	-	3.3	-	V
Thermal resistance (J to S)	R θ_{J-S}		6.2		K/W
View Angle	2 θ 1/2	120			deg.

1-2 Absolute Maximum Ratings

Parameter	Symbol	Value	Unit
Forward Current	I _F	1000	mA
		1000(1/10duty@1kHz)	
Reverse Voltage	V _R	5	V
Power Dissipation	P _d	4	W
Junction Temperature	T _j	145(@ I _F ≤ 1000mA)	°C
Operating Temperature	T _{opr}	-40 ~ +85	°C
Storage Temperature	T _{stg}	-40 ~ +100	°C
ESD Sensitivity [5]	-	± 8,000V HBM	-

*Notes :

- [1] SSC maintains a tolerance of ±10% on flux and power measurements.
- [2] Φ_V is the total luminous flux output as measured with an integrating sphere.
- [3] Correlated Color Temperature is derived from the CIE 1931 Chromaticity diagram.
Color coordinate : 0.005, CCT ±5% tolerance.
- [4] Tolerance is ±0.06V on forward voltage measurements
- [5] A zener diode is included to protect the product from ESD.

Characteristics of SZ5-P0-WW-C8

Warm White

1-1 Electro-Optical characteristics at 350mA

(Ta=25°C)

Parameter	Symbol	Value			Unit
		Min	Typ	Max	
Luminous Flux [1]	Φ_V [2]	-	85	-	lm
	$\Phi_V (T_j=100^\circ\text{C})$	-	83	-	
Correlated Color Temperature [3]	CCT	-	3000	-	K
CRI	R_a	80	-	-	-
Forward Voltage [4]	V_F	-	3.3	-	V
Thermal resistance (J to S)	$R_{\theta_{J-S}}$		6.2		K/W
View Angle	$2\theta \frac{1}{2}$		120		deg.

1-2 Absolute Maximum Ratings

Parameter	Symbol	Value	Unit
Forward Current	I_F	1000	mA
		1000(1/10duty@1kHz)	
Reverse Voltage	V_R	5	V
Power Dissipation	P_d	4	W
Junction Temperature	T_j	145(@ $I_F \leq 1000\text{mA}$)	°C
Operating Temperature	T_{opr}	-40 ~ +85	°C
Storage Temperature	T_{stg}	-40 ~ +100	°C
ESD Sensitivity [5]	-	± 8,000V HBM	-

*Notes :

- [1] SSC maintains a tolerance of ±10% on flux and power measurements.
- [2] Φ_V is the total luminous flux output as measured with an integrating sphere.
- [3] Correlated Color Temperature is derived from the CIE 1931 Chromaticity diagram.
Color coordinate : 0.005, CCT ±5% tolerance.
- [4] Tolerance is ±0.06V on forward voltage measurements
- [5] A zener diode is included to protect the product from ESD.

Forward Current Characteristics

Forward Voltage vs. Forward Current, Ta=25°C

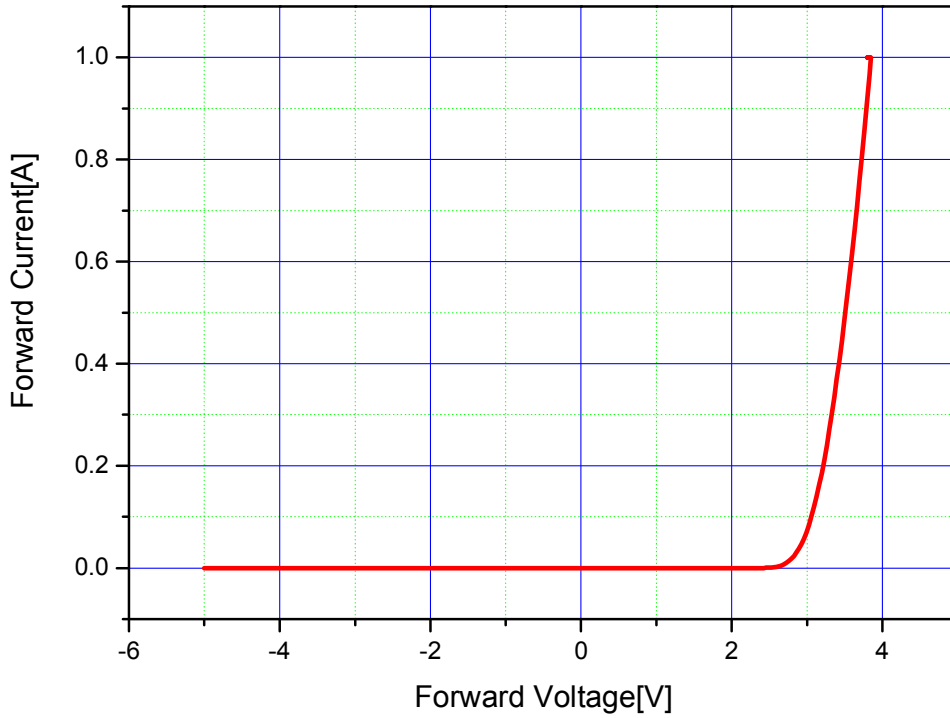

Forward Current vs. Normalized Relative Luminous Flux, Ta=25°C

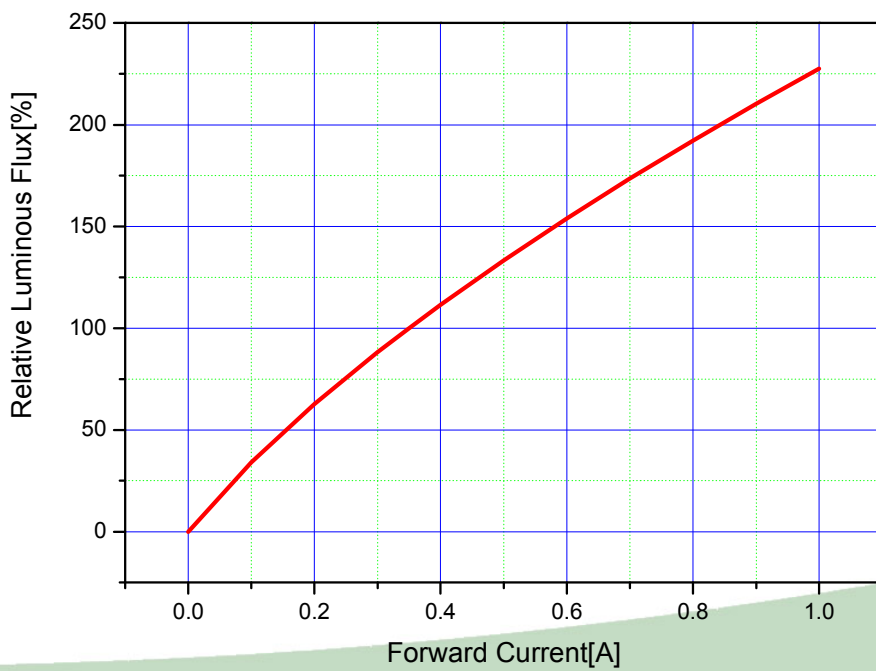

SSC-SZ5P

August 2011

www.seoulsemicon.com

Forward Current Characteristics

CCT vs. Forward Current, Ta=25℃

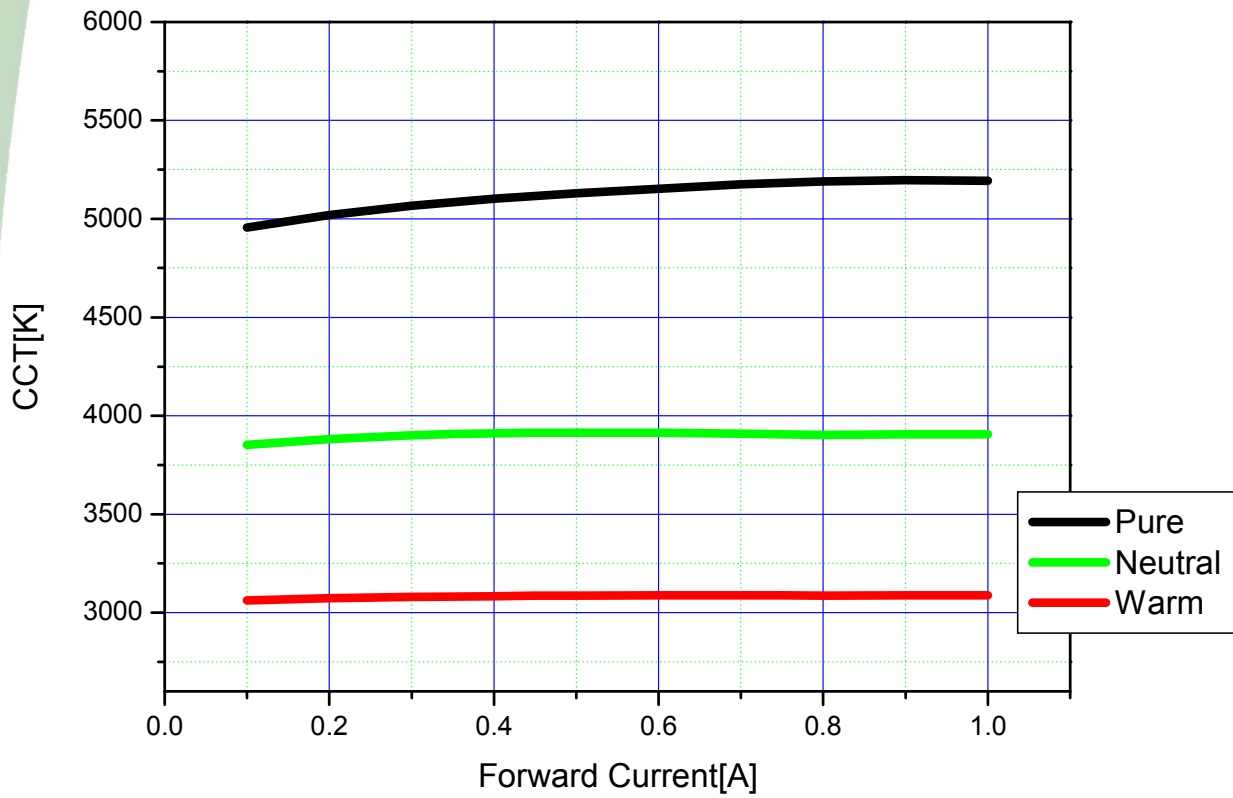

Ambient Temperature vs. Allowable Forward Current

Pure White, Neutral White, Warm White ($T_{jmax} = 145^{\circ}C, @1A$)

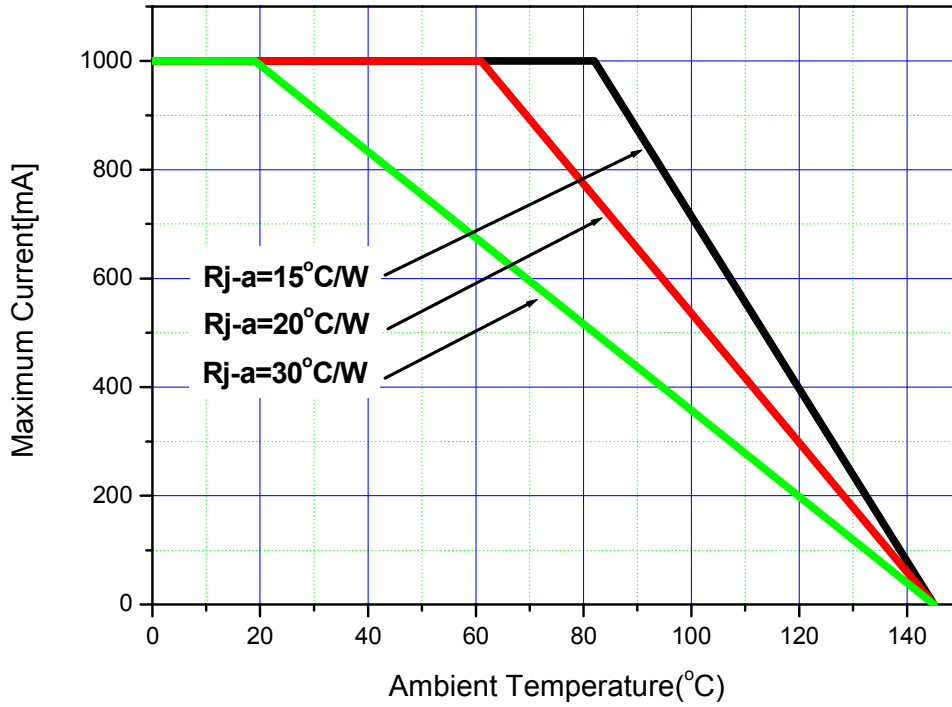

Radiation pattern

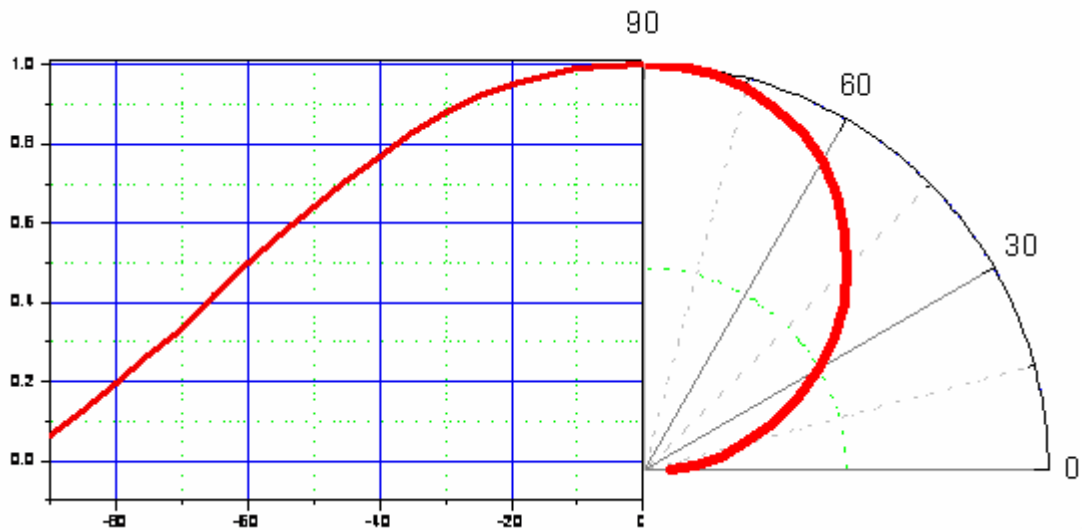

Current Color Spectrum, Ta=25°C

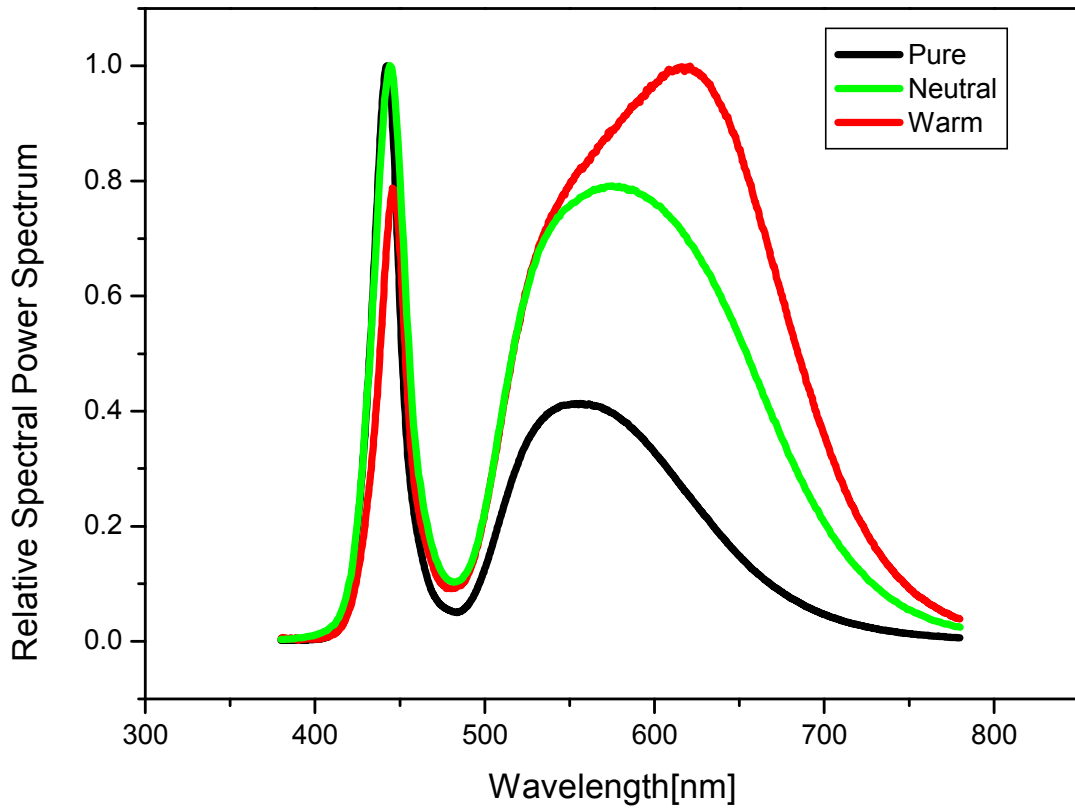

Junction Temperature Characteristics

Relative Light Output vs. Junction Temperature at IF=350mA

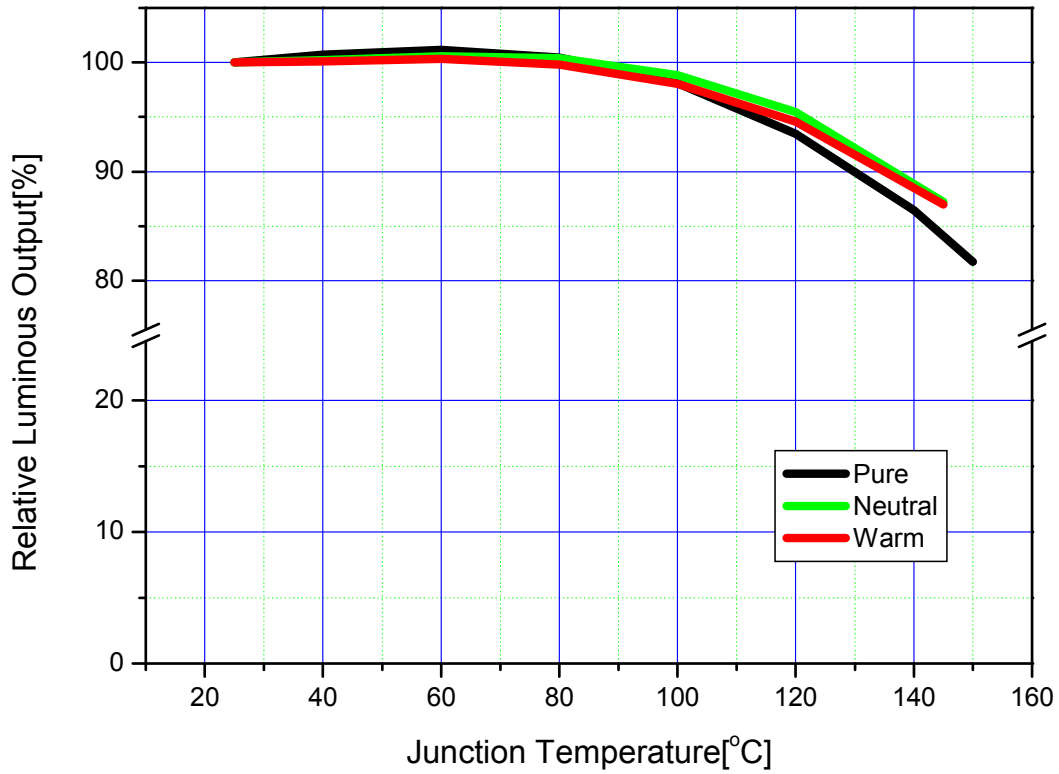

Junction Temperature Characteristics

VF vs. Junction Temperature at IF=350mA

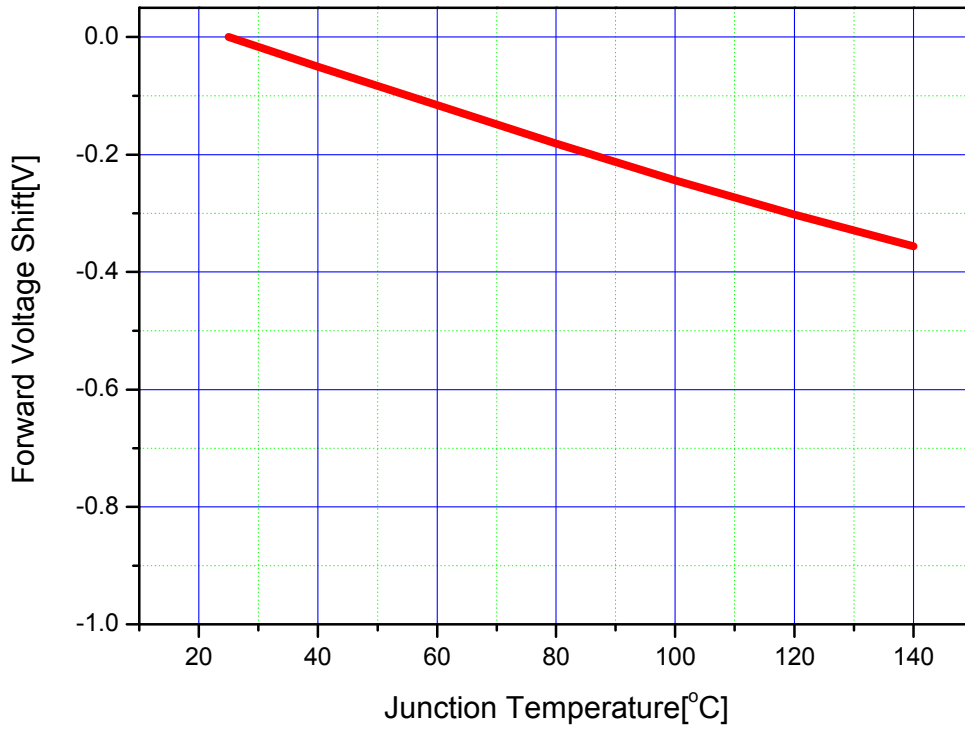

Junction Temperature Characteristics

CCT vs. Junction Temperature at IF=350mA

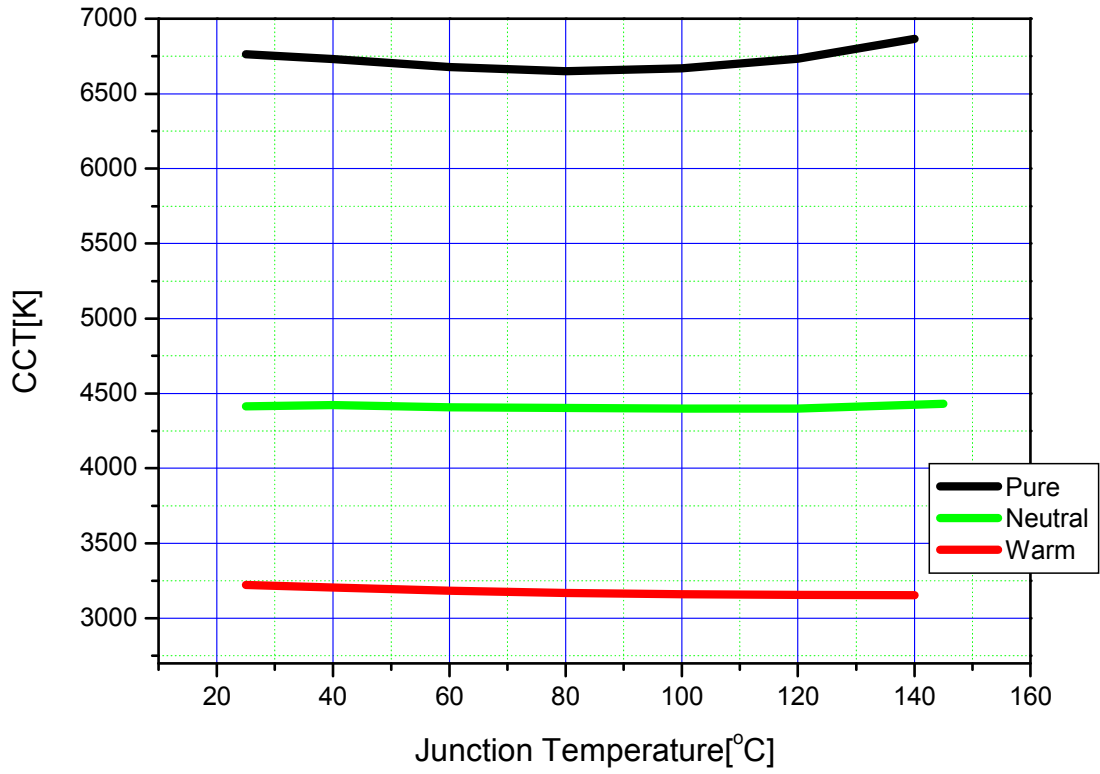

Outline dimensions

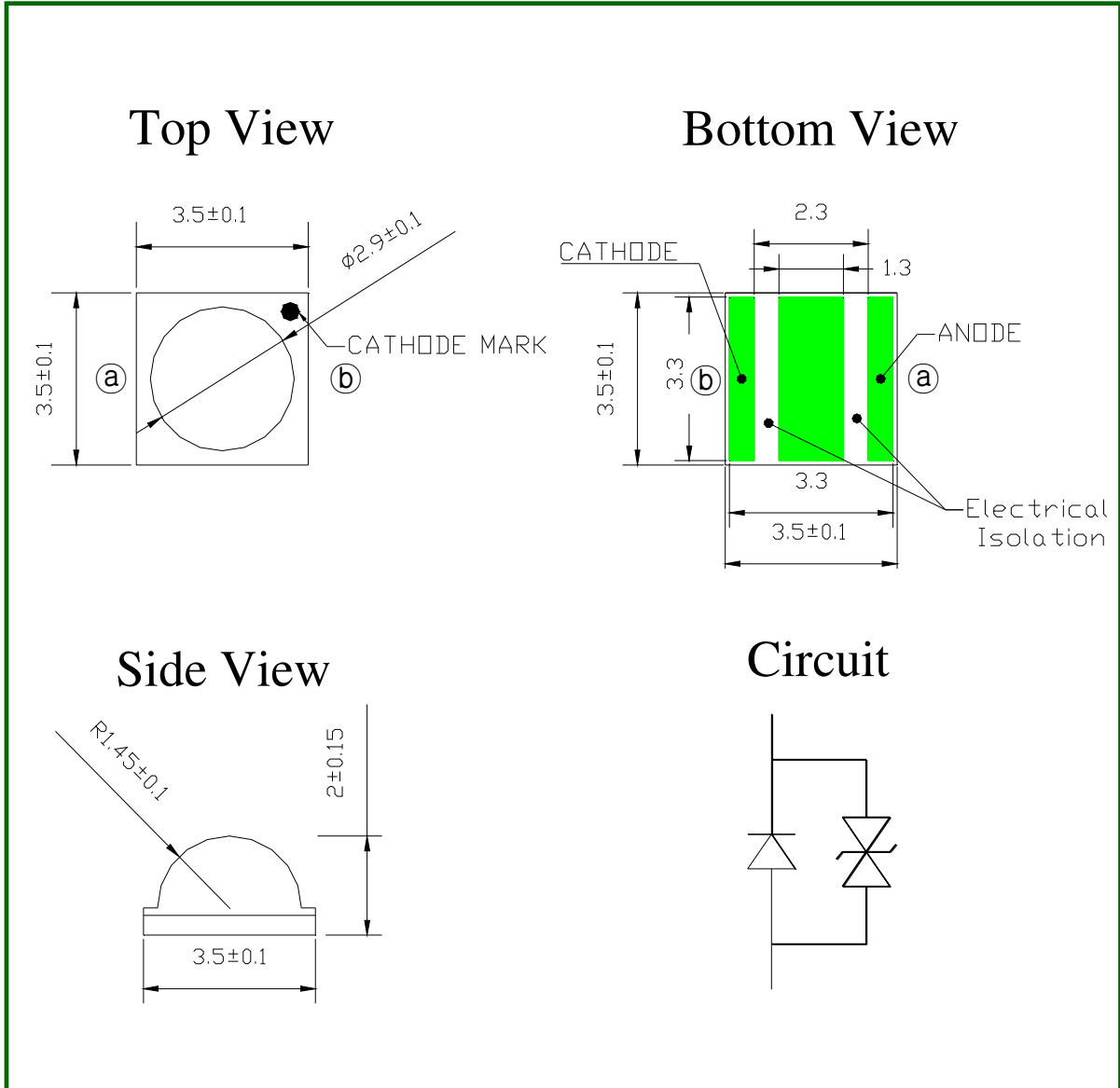

Notes :

- [1] All dimensions are in millimeters.
- [2] Scale : none
- [3] Undefined tolerance is ± 0.1mm

Recommended solder pad

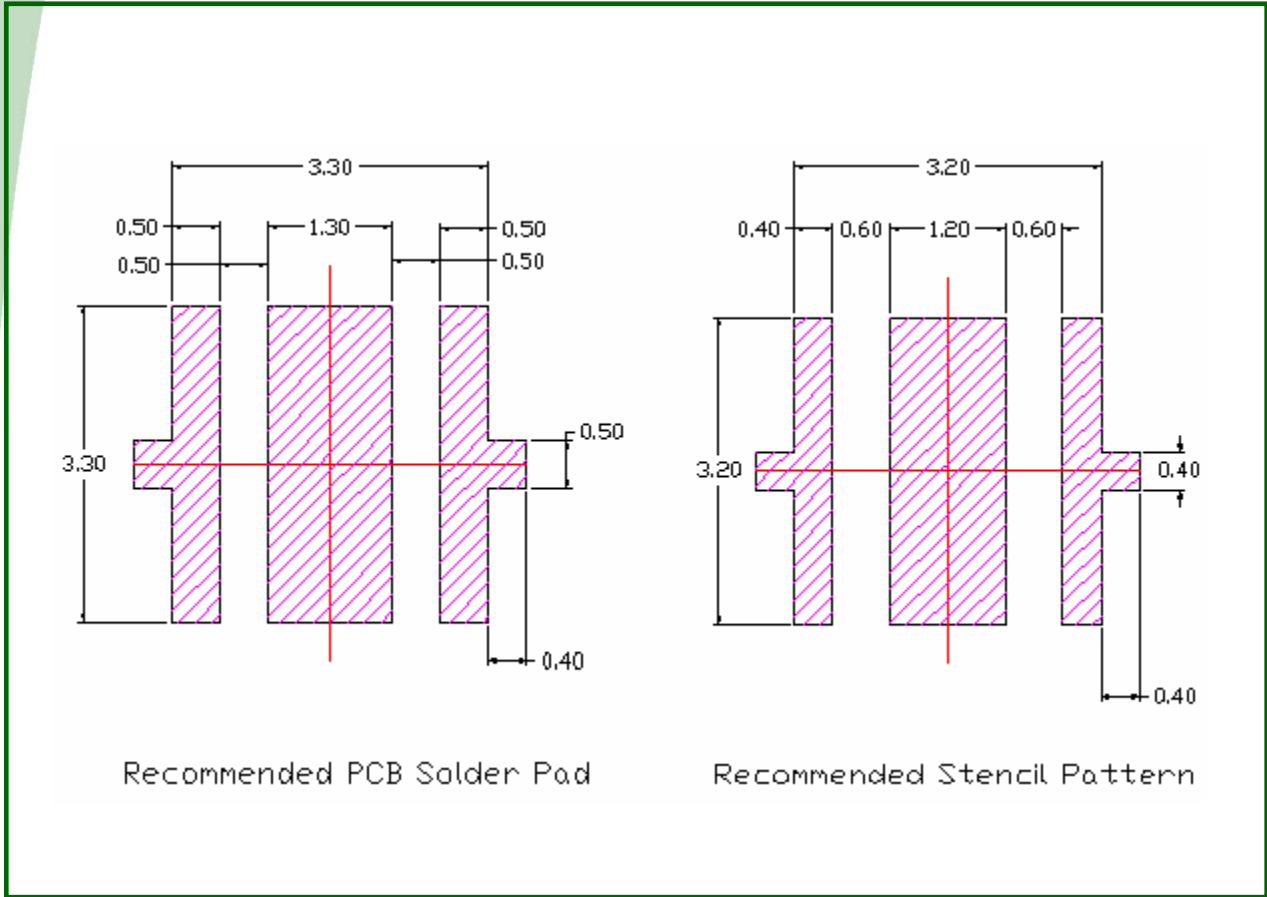

Recommended PCB Solder Pad

Recommended Stencil Pattern

Notes :

- [1] All dimensions are in millimeters.
- [2] Scale : none
- [3] This drawing without tolerances are for reference only

Label

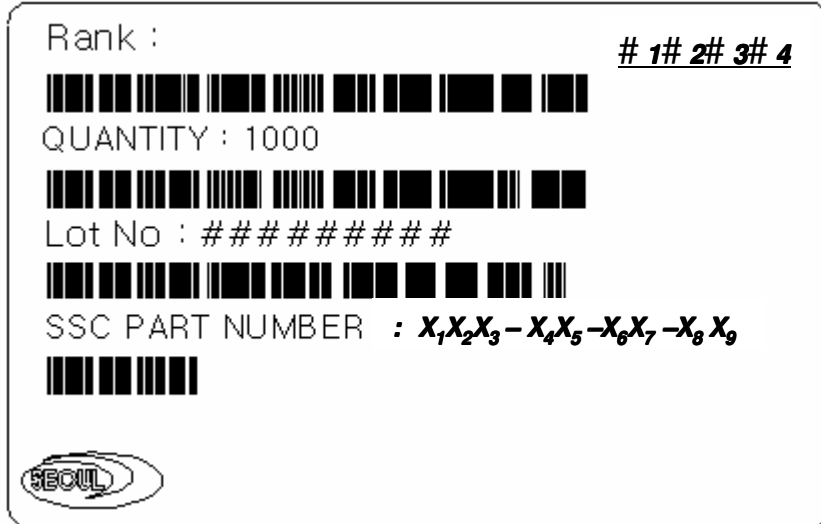

Full code form :

$X_1X_2X_3 - X_4X_5 - X_6X_7 - X_8X_9$

- $X_1X_2X_3$: Part Number
- X_4 : Series Code
- X_5 : Revision No
- X_6X_7 : Color specification
- X_8X_9 : CRI group

Rank

1# 2# 3# 4

- #1 : Luminous Flux : LF [lm]
- #2 #3 : Color Coordinates : x, y
- #4 : Forward Voltage : V_F [V]

Emitter Carrier & Reel Packaging

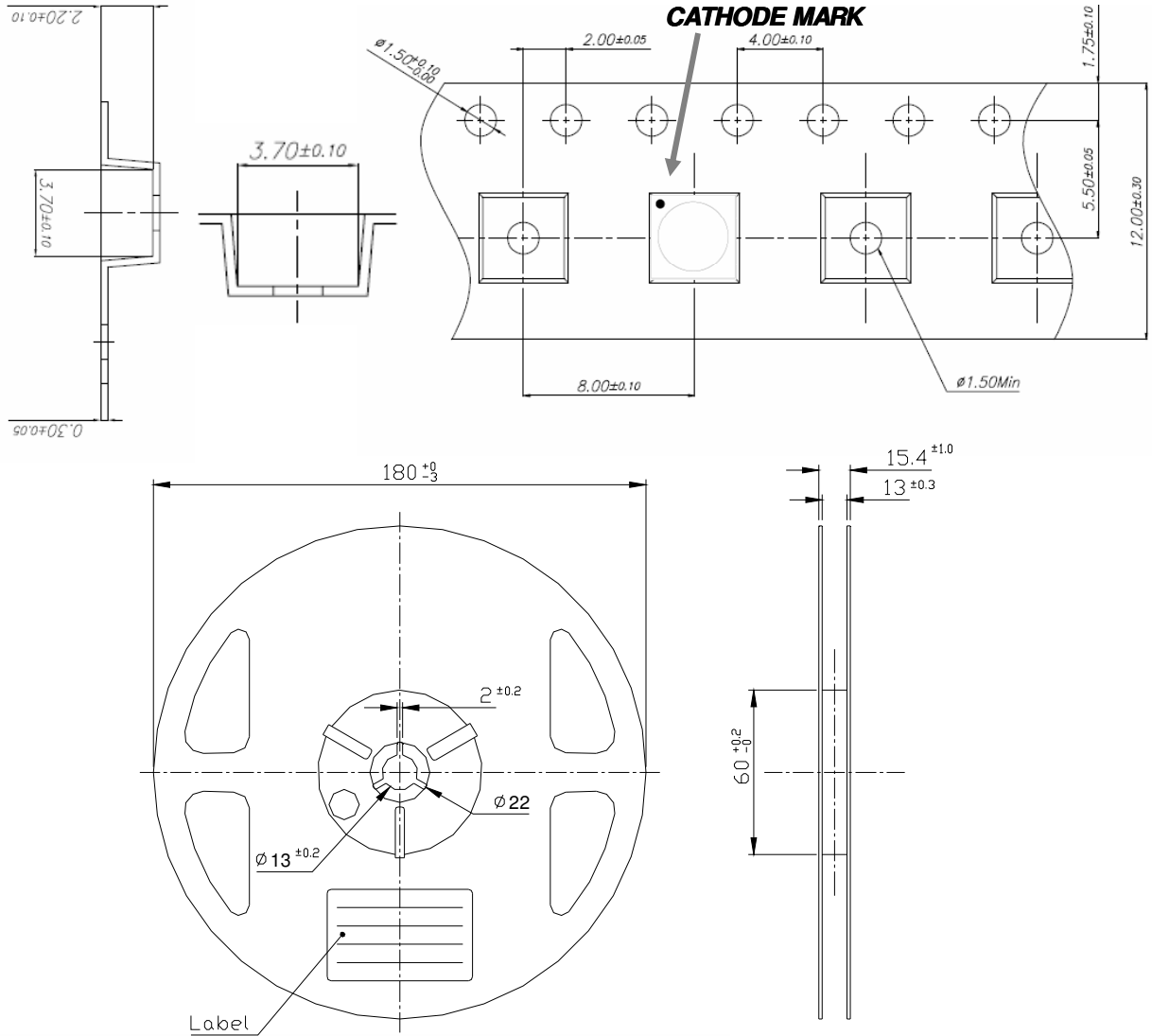

NOTES:

1. 10 sprocket hole pitch cumulative tolerance ± 0.20
2. Camber not to exceed 1mm in 250mm
3. Material: Black conductive Polystyrene
4. A_0 and B_0 measured on a plane 0.3mm above the bottom of the pocket
5. K_0 measured from a plane on the inside bottom of the pocket to the top surface of the carrier.
6. Pocket position relative to sprocket hole measured as true position of pocket, not pocket hole.
7. Pocket center and pocket hole center must be same position.

SSC-SZ5P

August 2011

www.seoulsemicon.com

Reflow Soldering Conditions / Profile

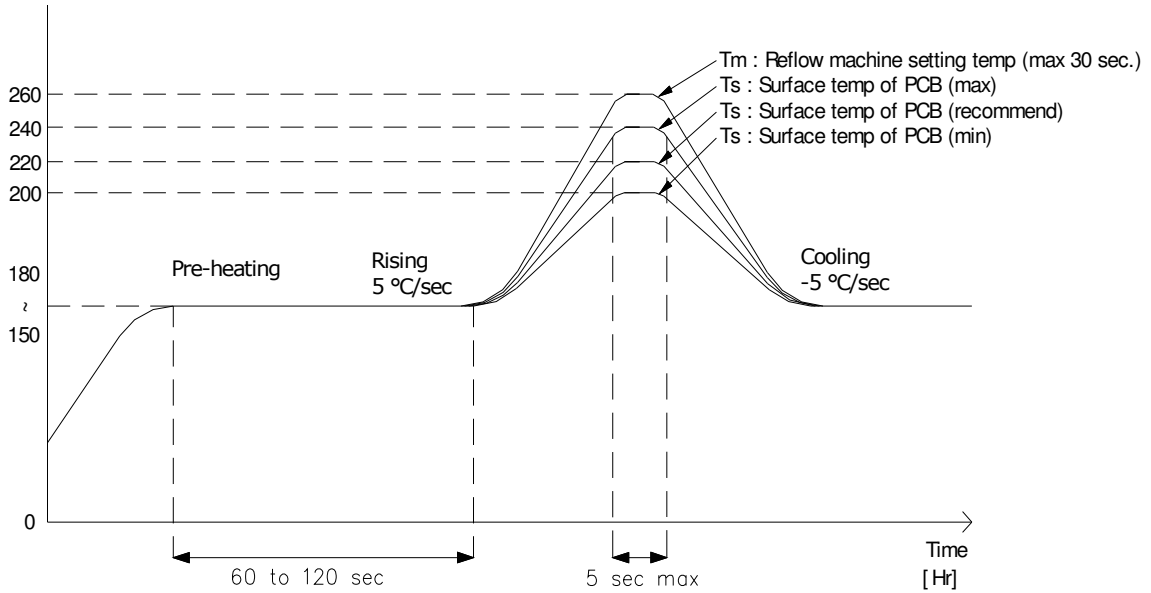

*** Caution**

1. Reflow soldering should not be done more than one time.
2. Repairs should not be done after the LEDs have been soldered. When repair is unavoidable, suitable tools must be used.
3. Die slug is to be soldered.
4. When soldering, do not put stress on the LEDs during heating.
5. After soldering, do not warp the circuit board.
6. Recommend to use a convection type reflow machine with 7 ~ 8 zones.

Precaution for use

- Storage

To avoid the moisture penetration, we recommend storing Z Power LEDs in a dry box with a desiccant . The recommended storage temperature range is 5C to 30C and a maximum humidity of 50%.

- Use Precaution after Opening the Packaging

Use proper SMD techniques when the LED is to be soldered dipped as separation of the lens may affect the light output efficiency.

Pay attention to the following:

a. Soldering should be done immediately after opening the package (within 24Hrs).

b. Required conditions after opening the package

- Sealing

- Temperature : 5 ~ 40°C Humidity : less than 30%

c. If the package has been opened more than 4 week or the color of the desiccant changes, components should be dried for 10-12hr at 60±5°C

- Do not apply mechanical force or excess vibration during the cooling process to normal temperature after soldering.

- Do not rapidly cool device after soldering.

- Components should not be mounted on warped (non coplanar) portion of PCB.

- Radioactive exposure is not considered for the products listed here in.

- Gallium arsenide is used in some of the products listed in this publication. These products are dangerous if they are burned or shredded in the process of disposal. It is also dangerous to drink the liquid or inhale the gas generated by such products when chemically disposed of.

- This device should not be used in any type of fluid such as water, oil, organic solvent and etc. When washing is required, IPA (Isopropyl Alcohol) should be used.

- When the LEDs are in operation the maximum current should be decided after measuring the package temperature.

- LEDs must be stored properly to maintain the device. If the LEDs are stored for 3 months or more after being shipped from SSC, a sealed container with a nitrogen atmosphere should be used for storage.

- The appearance and specifications of the product may be modified for improvement without notice.

- Long time exposure of sunlight or occasional UV exposure will cause lens discoloration.

- The slug is isolated from anode electrically.

Therefore, we recommend that you don't isolate the heat sink.

- Attaching LEDs, do not use adhesives that outgas organic vapor.

SSC-SZ5P

August 2011

www.seoulsemicon.com

Handling of Silicone resin LEDs

The Z-Power LED is encapsulated with a silicone resin for the highest flux efficiency.

Notes for handling:

- Avoid touching silicone resin parts especially with sharp tools such as Pincetter (Tweezers)
- Avoid leaving fingerprints on silicone resin parts.
- Silicone resin will attract dust so use covered containers for storage.
- When populating boards in SMT production, there are basically no restrictions regarding the form of the pick and place nozzle, except that excessive mechanical pressure on the surface of the resin must be prevented.
- It is not recommend to cover the silicone resin of the LEDs with other resin (epoxy, urethane, etc)

X-ON Electronics

Largest Supplier of Electrical and Electronic Components

Click to view similar products for [seoul semiconductor manufacturer](#):

Other Similar products are found below :

[STW8Q14BE-U0U7-AA](#) [SZ5-M1-W0-00-V3/W1-BA](#) [STW9Q14C-T0U0-FA](#) [STW8Q14BE-T0U7-FT](#) [STW8Q14BE-U0W5-AA](#)
[SMJC2V08W2P4-GA](#) [STW9Q14C-T0U0-GA](#) [SDW81F1C-C/D-GA](#) [STW8Q14BE-T5U0-FA](#) [SMJE3V04W1P3-CA \(220\)](#) [STW8Q14BE-S5T0-HA](#) [G42180-08](#) [SAW09H0A-V3W3-CA](#) [SMJE-2V12W2P4-EA](#) [S1CH-3535660003-00000000-00001](#) [STW8C2SA-J19K24-EA](#)
[SZR05A0A](#) [B42180-08](#) [STW8T16C-Q0S0-HA](#) [C9WT803](#) [STW8Q14BE-T0U7-FB](#) [SZ5-M1-WW-C8-V1/V3-FA](#) [SAW8WA2A-L37/M40-BA](#) [SAW09H0A-V3W3-DA](#) [STW8Q14BE-U0U7-DA](#) [SMJE-2V12W2P4-CA](#) [STW8Q2PA-S5T5-CA](#) [SFT722N-S](#) [STW8B12C-AABL](#)
[SAW0LH0A-W1/W2-BA](#) [SAW8WA2A-L32L35-BA](#) [SZ5-M1-W0-00-V3/W2-AA](#) [SMJE-2V12W2P4-HA](#) [STW0Q2PA](#) [STW8Q14C-V5W5-FA](#) [STW8T16C-Q0S0-EA](#) [STW8Q14BE-U0W5-EA](#) [SAW8LH0A-V2/W1-GA](#) [SZ5-M0-W0-00-TWM](#) [SZ5-M1-WN-00-V2W3-EA](#) [SMJE-2V08W2P4-HA](#) [SAW8A32E-MinL35-H4C](#) [SMJE-2V08W2P4-EA](#) [SMJE-2V08W2P4-CA](#) [SZ5-M0-WN-00](#) [F50360](#) [STW8Q2PA-R5-HA](#)
[SAW8A32E-MinL37-C4C](#) [STW8Q14BE-T0V5-GA](#) [SAW8WA2A-L30L32-GA](#)