

LS-Titan Miniature DIN Switches



## 46.3 LS-Titan Miniature DIN Switches

Product Description . . . . .	2
Features . . . . .	2
Standards and Certifications . . . . .	2
Product Identification . . . . .	3
Product Selection . . . . .	4
Accessories . . . . .	14
Technical Data and Specifications . . . . .	15
Contact Travel Diagrams . . . . .	18
Dimensions . . . . .	21

## 45.1 LS-Titan Safety Interlock Switches

Product Description . . . . .	24
Features . . . . .	24
Standards and Certifications . . . . .	24
Product Identification . . . . .	25
Product Selection . . . . .	26
Technical Data and Specifications . . . . .	29
Mounting Instructions . . . . .	30
Dimensions . . . . .	31

LS-Titan Safety Interlock Switches



**Note:** Supplement to Volume 8—Sensing Solutions, CA08100010E, Tabs 46 and 45.

LS-Titan Miniature DIN Switches



### Contents

<i>Description</i>	<i>Page</i>
LS-Titan Miniature DIN Switches	
Product Identification . . . . .	3
Product Selection . . . . .	4
LS-Titan Plastic Safety Switches . . . . .	4
LS-Titan Plastic Electronic Safety Position Switches . . . . .	7
LS-Titan Metal Safety Switches . . . . .	11
Understanding LS-Titan Electronic Safety Position Switches . . . . .	13
Operating Point Adjustment . . . . .	13
Accessories . . . . .	14
Technical Data and Specifications . . . . .	15
Contact Travel Diagrams . . . . .	18
Dimensions . . . . .	21

### LS-Titan Miniature DIN Switches

#### Product Description

Eaton's LS-Titan™ limit switch line is a complete offering of safety position switches designed for worldwide application. Economical insulated plastic or rugged metal enclosures and modular, plug-in operating heads and bodies make LS-Titan a flexible switching solution.

A highlight of the LS-Titan switch line is the world's first electronic position switch (LSE models). These switches feature freely programmable operating points that can be set individually at any time. Additional LSE models provide analog outputs proportional to the actuator position.

LS-Titan switches are suitable for use in safety applications designed to protect persons or processes.

#### Features

- Modular, plug-in system (head and body components)
- Positive opening NC contacts for safety applications
- Wide variety of economical plastic and rugged metal versions available
- Operating heads can be rotated 90 degrees to suit specific direction of operation
- Unique electronic safety position switches (LSE models) provide analog (0–10 Vdc or 4–20 mA) outputs proportional to the actuator position and allow for easy configuration of a custom trip point

- Can be ordered as separate components (head and body) or as completely assembled switches
- Screw and Cage Clamp® (standard on LSE models and optionally available on mechanical models) connections provide larger wiring areas for easier installation
- Approved for worldwide application

#### Standards and Certifications

- Safety function by positive opening contacts per IEC/EN 60947-5-1 up to Category 4 per EN 954-1
- TÜV-Rheinland Certified for Functional-Safety (LSE models)
- CSA® certified
- UL® listed
- CE
- CCC



**Note:** Cage Clamp is a registered trademark of Wago Kontakttechnik, 32423 Minden, Germany.

For the most current information on this product, visit our web site: [www.eaton.com](http://www.eaton.com)

## Product Identification

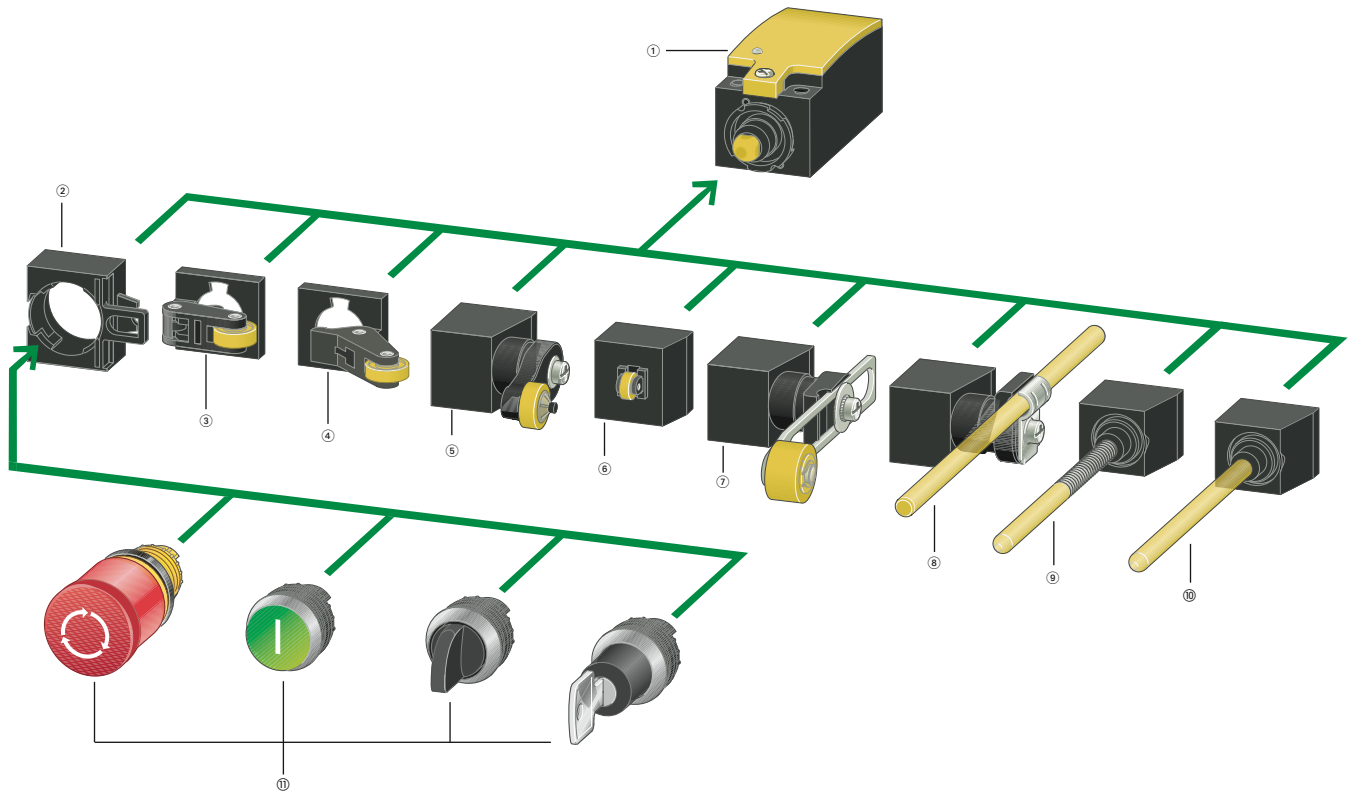

## Notes

- ① **Basic device** (see Pages 4–12)  
 According to EN 50047  
 With screw-on cover  
 Contacts: 1NO-1NC, 2NO, 2NC  
 Cage Clamp, screw terminal  
 As snap-action or standard-action switch  
 As electronic snap-action switch  
 (individually adjustable)  
 As 4–20 mA analog signal encoder  
 As 0–10 Vdc analog signal encoder
- ② **Fixing adapter** (see Page 14)  
 Allows mounting of M22 pushbuttons
- ③ **Roller lever** (see Pages 4 and 7)  
 For one-sided operation with higher operating speed
- ④ **Angled roller lever**  
 (see Pages 4, 7 and 11)  
 For actuation along the unit axis
- ⑤ **Rotary lever** (see Pages 4, 8 and 11)  
 For actuation from the side, for pendulum movements
- ⑥ **Roller plunger** (see Pages 4, 7 and 11)  
 For actuation from the side with low actuating force
- ⑦ **Adjustable roller lever**  
 (see Pages 5, 8, 9 and 11)  
 For length adjustment as required
- ⑧ **Actuating rod** (see Pages 6, 10 and 12)  
 On conveyor belts for lightweight goods
- ⑨ **Spring-rod** (see Pages 6, 10 and 12)  
 For flexible actuation from all sides
- j **Actuating rod** (see Pages 6, 10 and 12)  
 Withdrawable mechanism from front
- k Pushbuttons from the M22 family; see M22 catalog (CA04716001E) or [www.eaton.com/m22](http://www.eaton.com/m22)

**Operating heads can be rotated by 90 degrees.**

#### Product Selection

#### LS-Titan Plastic Safety Switches

46

##### Plastic Safety Switch Body



##### Assembled Switch



#### Plastic Safety Switches

##### Switch Body Catalog Number

##### Output Function

##### Terminal Connection

##### Contact Sequence

##### Contact Travel

- = contact closed
- = contact open

##### Operating Head Type ②

##### Head Only Catalog Number

##### LS-S02

2NC with positive opening contacts

Screw terminal ①

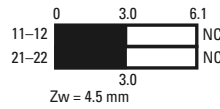

##### LS-S20A

2NO with slow make/break

Screw terminal ①

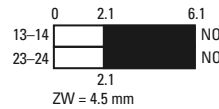

##### LS-S11S

1NO and 1NC with positive opening contact

Screw terminal ①



##### Snap-action contact

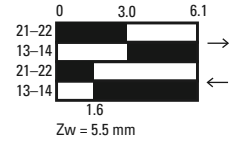

##### Top Push Roller Plunger



LS-XP

LS-S02-P

LS-S20A-P

LS-S11S-P

##### Long Roller Lever



LS-XL

LS-S02-L

LS-S20A-L

LS-S11S-L

##### Short Roller Lever



LS-XLS

LS-S02-LS

LS-S20A-LS

LS-S11S-LS

##### Large Roller Lever



LS-XLB

LS-S02-LB

LS-S20A-LB

LS-S11S-LB

##### Angled Roller



LS-XLA

LS-S02-LA

LS-S20A-LA

LS-S11S-LA

##### Rotary Lever



LS-XRL

LS-S02-RL

LS-S20A-RL

LS-S11S-RL

#### Notes

① Cage Clamp versions available. Contact Application Engineering.

② For operating head dimensions, see **Page 21**.

Plastic Safety Switch Body



Assembled Switch



Plastic Safety Switches, continued

Switch Body Catalog Number

Output Function

Terminal Connection

Contact Sequence

Contact Travel

■ = contact closed  
□ = contact open

Operating Head Type ②

Head Only Catalog Number

LS-S02

2NC with positive opening contacts

Screw terminal ①

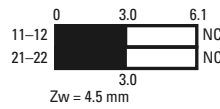

LS-S20A

2NO with slow make/break

Screw terminal ①

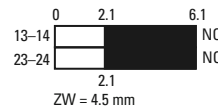

LS-S11S

1NO and 1NC with positive opening contact

Screw terminal ①

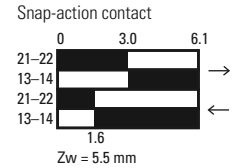

Assembled Switch Catalog Number

Adjustable Roller Lever (with 18 mm Roller)



LS-XRLA

LS-S02-RLA

LS-S20A-RLA

LS-S11S-RLA

Adjustable Roller Lever (with 30 mm Roller)



LS-XRLA30

LS-S02-RLA30

LS-S20A-RLA30

LS-S11S-RLA30

Adjustable Roller Lever (with 40 mm Roller)



LS-XRLA40

LS-S02-RLA40

LS-S20A-RLA40

LS-S11S-RLA40

Adjustable Roller Lever (with 40 mm Rubber Roller)



LS-XRLA40R

LS-S02-RLA40R

LS-S20A-RLA40R

LS-S11S-RLA40R

Notes

- ① Cage Clamp versions available. Contact Application Engineering.
- ② For operating head dimensions, see Page 21.

# 46.3

## Limit Switches

### LS-Titan Miniature DIN Switches

46

Plastic Safety Switch Body



Assembled Switch



#### Plastic Safety Switches, continued

Switch Body Catalog Number

Output Function

Terminal Connection

Contact Sequence

Contact Travel

■ = contact closed  
□ = contact open

Operating Head Type ②

Head Only Catalog Number

LS-S02

2NC with positive opening contacts

Screw terminal ①

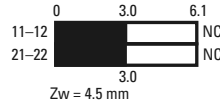

LS-S20A

2NO with slow make/break

Screw terminal ①

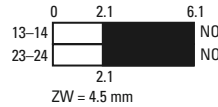

LS-S11S

1NO and 1NC with positive opening contact

Screw terminal ①



Snap-action contact

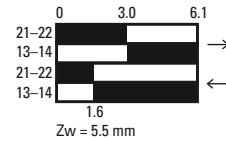

Assembled Switch Catalog Number

Plastic Rod Lever



LS-XRR

LS-S02-RR

LS-S20A-RR

LS-S11S-RR

Metal Rod



LS-XRRM

LS-S02-RRM

LS-S20A-RRM

LS-S11S-RRM

Spring Rod (Wobble) ③



LS-XS

LS-S02-S

LS-S20A-S

LS-S11S-S

Actuating Rod



LS-XOR

LS-S02-OR

LS-S20A-OR

LS-S11S-OR

#### Notes

- ① Cage Clamp versions available. Contact Application Engineering.
- ② For operating head dimensions, see **Page 21**.
- ③ Not to be used as a safety position switch. Use only in conjunction with snap-action contact.

**LS-Titan Plastic Electronic Safety Position Switches**

**Plastic Electronic Safety Position Switch Body**



**Assembled Switch**



**Plastic Electronic Safety Position Switches**

**Switch Body**

**Catalog Number**

**LSE-11**

**LSE-02**

**LSE-AI**

**LSE-AU**

**Output Function**

1NO and 1 NC

2NC

Analog 4–20 mA

Analog 0–10V

**Terminal Connections**

Cage Clamp ①

Cage Clamp ①

Cage Clamp ①

Cage Clamp ①

**Safety Functions and Approvals**

These models may be used in safety-oriented circuits. Visual status LED indication is comparable to positive opening contacts. Certified by TÜV as a “Functional-Safety” device. Suitable for protection of people or processes.

Additional diagnostic output that registers a 0V signal in the event of a fault. Self-test function continuously tests both outputs for overloads, short circuits to 0V and short circuits to +U<sub>e</sub>. Certified by TÜV to EN 954-1, Category 3 or 4. Suitable for protection of people or processes.



**Contact Sequence**

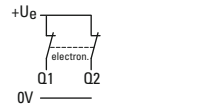
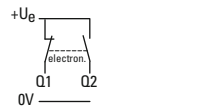

Analog 4–20 mA

Analog 0–10V

**Contact Travel**

■ = contact closed

□ = contact open

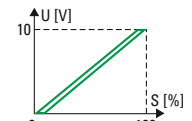
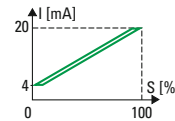
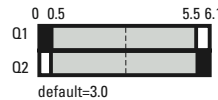
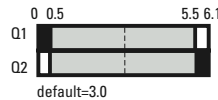

**Operating Head Type ②**

**Head Only**

**Catalog Number**

**Assembled Switch  
Catalog Number**

**Top Push Roller Plunger**



LS-XP

LSE-11-P

LSE-02-P

LSE-AI-P

LSE-AU-P

**Long Roller Lever**



LS-XL

LSE-11-L

LSE-02-L

LSE-AI-L

LSE-AU-L

**Short Roller Lever**



LS-XLS

LSE-11-LS

LSE-02-LS

LSE-AI-LS

LSE-AU-LS

**Large Roller Lever**



LS-XLB

LSE-11-LB

LSE-02-LB

LSE-AI-LB

LSE-AU-LB

**Angled Roller**



LS-XLA

LSE-11-LA

LSE-02-LA

LSE-AI-LA

LSE-AU-LA

**Notes**

① A compatible Cage Clamp tool is available as an accessory on **Page 14**.

② For operating head dimensions, see **Page 21**.

**Plastic Electronic Safety Position Switch Body**



**Assembled Switch**



**Plastic Electronic Safety Position Switches, continued**

**Switch Body**

**Catalog Number**

**LSE-11**

**LSE-02**

**LSE-AI**

**LSE-AU**

**Output Function**

1NO and 1NC

2NC

Analog 4–20 mA

Analog 0–10V

**Terminal Connections**

Cage Clamp ①

Cage Clamp ①

Cage Clamp ①

Cage Clamp ①

**Safety Functions and Approvals**

These models may be used in safety-oriented circuits. Visual status LED indication is comparable to positive opening contacts. Certified by TÜV as a "Functional-Safety" device. Suitable for protection of people or processes.

Additional diagnostic output that registers a 0V signal in the event of a fault. Self-test function continuously tests both outputs for overloads, short circuits to 0V and short circuits to +U<sub>e</sub>. Certified by TÜV to EN 954-1, Category 3 or 4. Suitable for protection of people or processes.



**Contact Sequence**

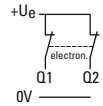
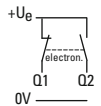

Analog 4–20 mA

Analog 0–10V

**Contact Travel**

■ = contact closed  
□ = contact open

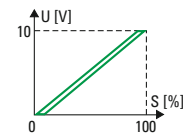
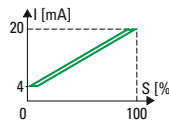
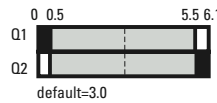
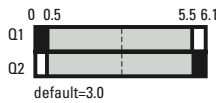

**Operating Head Type ②**

**Head Only**

**Catalog Number**

**Assembled Switch**

**Catalog Number**

**Rotary Lever**



**LS-XRL**

**LSE-11-RL**

**LSE-02-RL**

**LSE-AI-RL**

**LSE-AU-RL**

**Adjustable Roller Lever (with 18 mm Roller)**



**LS-XRLA**

**LSE-11-RLA**

**LSE-02-RLA**

**LSE-AI-RLA**

**LSE-AU-RLA**

**Adjustable Roller Lever (With 30 mm Roller)**



**LS-XRLA30**

**LSE-11-RLA30**

**LSE-02-RLA30**

**LSE-AI-RLA30**

**LSE-AU-RLA30**

**Notes**

- ① A compatible Cage Clamp tool is available as an accessory on **Page 14**.
- ② For operating head dimensions, see **Page 21**.



Plastic Electronic Safety Position Switches, continued

Plastic Electronic Safety Position Switch Body



Assembled Switch



Switch Body Catalog Number	LSE-11	LSE-02	LSE-AI	LSE-AU
<b>Output Function</b>	1NO and 1NC	2NC	Analog 4–20 mA	Analog 0–10V
<b>Terminal Connections</b>	Cage Clamp ①	Cage Clamp ①	Cage Clamp ①	Cage Clamp ①
<b>Safety Functions and Approvals</b>	These models may be used in safety-oriented circuits. Visual status LED indication is comparable to positive opening contacts. Certified by TÜV as a “Functional-Safety” device. Suitable for protection of people or processes.		Additional diagnostic output that registers a 0V signal in the event of a fault. Self-test function continuously tests both outputs for overloads, short circuits to 0V and short circuits to +U <sub>e</sub> . Certified by TÜV to EN 954-1, Category 3 or 4. Suitable for protection of people or processes.	



Contact Sequence

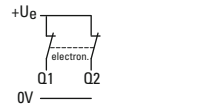
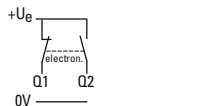

Analog 4–20 mA

Analog 0–10V

Contact Travel

■ = contact closed  
□ = contact open

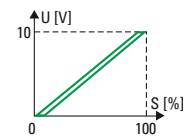
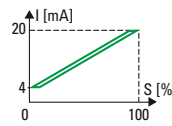
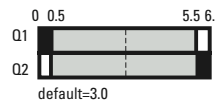
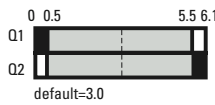

Operating Head Type ②

Head Only Catalog Number	Assembled Switch Catalog Number
--------------------------	---------------------------------

Adjustable Roller Lever (With 40 mm Roller)



LS-XRLA40	LSE-11-RLA40	LSE-02-RLA40	LSE-AI-RLA40	LSE-AU-RLA40
-----------	--------------	--------------	--------------	--------------

Adjustable Roller Lever (With 40 mm Roller)



LS-XRLA40R	LSE-11-RLA40R	LSE-02-RLA40R	LSE-AI-RLA40R	LSE-AU-RLA40R
------------	---------------	---------------	---------------	---------------

Plastic Rod Lever



LS-XRR	LSE-11-RR	LSE-02-RR	LSE-AI-RR	LSE-AU-RR
--------	-----------	-----------	-----------	-----------

Notes

- ① A compatible Cage Clamp tool is available as an accessory on Page 14.
- ② For operating head dimensions, see Page 21.

**Plastic Electronic Safety Position Switch Body**



**Assembled Switch**



**Plastic Electronic Safety Position Switches, continued**

**Switch Body**

**Catalog Number**

**LSE-11**

**LSE-02**

**LSE-AI**

**LSE-AU**

**Output Function**

1NO and 1NC

2NC

Analog 4–20 mA

Analog 0–10V

**Terminal Connections**

Cage Clamp ①

Cage Clamp ①

Cage Clamp ①

Cage Clamp ①

**Safety Functions and Approvals**

These models may be used in safety-oriented circuits. Visual status LED indication is comparable to positive opening contacts. Certified by TÜV as a “Functional-Safety” device. Suitable for protection of people or processes.

Additional diagnostic output that registers a 0V signal in the event of a fault. Self-test function continuously tests both outputs for overloads, short circuits to 0V and short circuits to +U<sub>e</sub>. Certified by TÜV to EN 954-1, Category 3 or 4. Suitable for protection of people or processes.



**Contact Sequence**

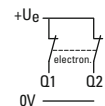
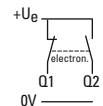

Analog 4–20 mA

Analog 0–10V

**Contact Travel**

■ = contact closed  
□ = contact open

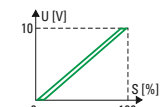
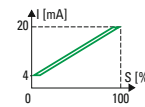
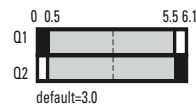

**Operating Head Type ②**

**Head Only Catalog Number**

**Assembled Switch Catalog Number**

**Metal Rod**



**LS-XRRM**

**LSE-11-RRM**

**LSE-02-RRM**

**LSE-AI-RRM**

**LSE-AU-RRM**

**Spring Rod (Wobble) ③**



**LS-XS**

**LSE-11-S**

**LSE-02-S**

**LSE-AI-S**

**LSE-AU-S**

**Actuating Rod**



**LS-XOR**

**LSE-11-OR**

**LSE-02-OR**

**LSE-AI-OR**

**LSE-AU-OR**

**Notes**

- ① A compatible Cage Clamp tool is available as an accessory on **Page 14**.
- ② For operating head dimensions, see **Page 21**.
- ③ Not to be used as a safety position switch. Use only in conjunction with snap-action contact.

**LS-Titan Metal Safety Switches**

**Metal Safety Switch Body**



**Assembled Switch**



**Metal Safety Switches**

**Switch Body Catalog Number**

**Output Function**

**Terminal Connection**

**Contact Sequence**

**Contact Travel**

■ = contact closed

□ = contact open

**Operating Head Type ①**

**Head Only Catalog Number**

**LSM-02**

2NC with positive opening contacts

Cage Clamp

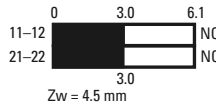

**LSM-20A**

2NO with slow make/break

Cage Clamp

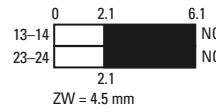

**LSM-11S**

1NO and 1NC with positive opening contact

Cage Clamp



Snap-action contact

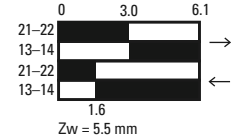

**Assembled Switch Catalog Number**

**Top Push Roller Plunger**



**LSM-XP**

**LSM-02-P**

**LSM-20A-P**

**LSM-11S-P**

**Long Roller Lever**



**LSM-XL**

**LSM-02-L**

**LSM-20A-L**

**LSM-11S-L**

**Angled Roller**



**LSM-XLA**

**LSM-02-LA**

**LSM-20A-LA**

**LSM-11S-LA**

**Rotary Lever**



**LSM-XRL**

**LSM-02-RL**

**LSM-20A-RL**

**LSM-11S-RL**

**Adjustable Roller Lever**



**LSM-XRLA**

**LSM-02-RLA**

**LSM-20A-RLA**

**LSM-11S-RLA**

**Note**

① For operating head dimensions, see Page 21.

# 46.3

## Limit Switches

### LS-Titan Miniature DIN Switches

46

**Metal Safety Switch Body**



**Assembled Switch**



### Metal Safety Switches, continued

**Switch Body Catalog Number**

**Output Function**

**Terminal Connection**

**Contact Sequence**

**Contact Travel**

■ = contact closed

□ = contact open

**Operating Head Type** ①

**Head Only**

**Catalog Number**

**LSM-02**

2NC with positive opening contacts

Cage Clamp

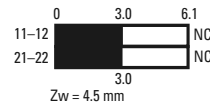

**LSM-20A**

2NO with slow make/break

Cage Clamp

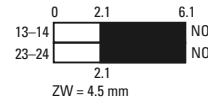

**LSM-11S**

1NO and 1NC with positive opening contact

Cage Clamp



Snap-action contact

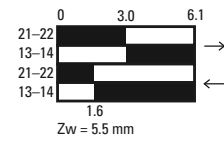

**Assembled Switch Catalog Number**

**Plastic Rod Lever**



**LSM-XRR**

**LSM-02-RR**

**LSM-20A-RR**

**LSM-11S-RR**

**Metal Rod Lever**



**LSM-XRRM**

**LSM-02-RRM**

**LSM-20A-RRM**

**LSM-11S-RRM**

**Spring Rod (Wobble)**



**LSM-XS**

**LSM-02-S**

**LSM-20A-S**

**LSM-11S-S**

**Note**

① For operating head dimensions, see **Page 21**.

### Understanding LS-Titan Electronic Safety Position Switches

All four LS-Titan LSE switch bodies are safety-rated products. The LSE-11 and LSE-02 switch bodies both have a freely programmable operating point and can be individually adjusted to suit the application, and can be changed as often as required. These devices feature an LED on the body, providing simple indication during programming and operation.

The LSE-AI (4–20 mA) and LSE-AU (0–10V) analog position switches take position data and convert to an analog current or voltage value that can then be continuously fed into an automation system. These two switches also feature a diagnostic output for additional data processing.

This ensures that a safe operating state can be monitored and evaluated at any time. A self-test function is also present on these models. Outputs Q1 and Q2 are continuously tested for overloads, short circuits to 0V and short circuits to +U<sub>e</sub>.

Like the electromechanical position switches, LS-Titan electronic position switches meet Category 3 or 4 of the EN 954-1 standard for machine safety when configured as a redundant system. All devices are thus suitable for safety applications that are used for the protection of persons or processes.

### Operating Point Adjustment

#### LSE-11

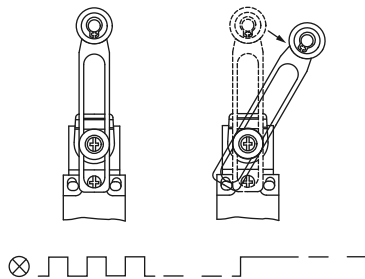

#### LSE-02

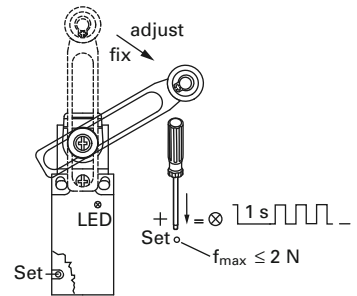

### Example of LS-Titan LSE Models in a Safety-Oriented Circuit

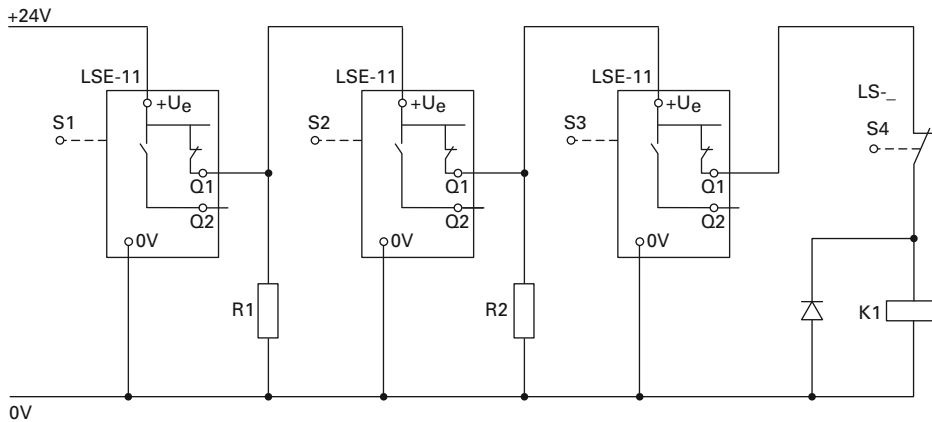



#### Notes

- LSE-11 and LSE-02—individual operating point adjustment.
- LSE-11 and LSE-02 can be used in safety circuits.
- S1 is connected to 24 Vdc
- S2, S3 each switch with a delay of 0.7s
- R1, R2, e.g., series element M22-XLED60 (2820 ohms/0.5W)

#### Accessories

46

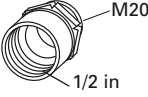
#### LS-Titan Safety Switches

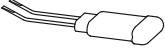
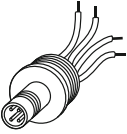
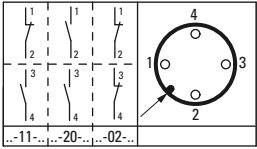
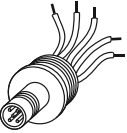
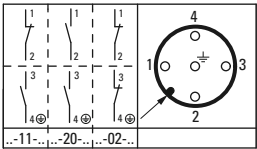
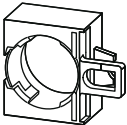
	For Use With	Description	Notes	Catalog Number
<b>V1-2-M20</b> 	Any	M20 screw terminal in 1/2 in. For use with American pipe thread, metal.	The screw connection must be earthed. Not total insulation.	<b>V1-2-M20-NA</b>
	Any	M20 screw terminal in 1/2 in. For use with American pipe thread, molded material.	—	<b>V1-2-M20</b>
<b>EMS20</b> 	Any	M20 diaphragm bolt. With internal push-through membrane. Will fit cable with an external diameter of up to 13 mm. Rated IP65 with cable inserted.	—	<b>EMS20</b>
<b>LS-XTW</b> 	Any	Cage Clamp tool.	—	<b>LS-XTW</b>
<b>M12A</b> 	LS-Titan plastic bodies (LS-_)	Plug connector, 12 mm, 4-pin male connector M12x1 (M12x1). Rated IP65. Molded material. Color coded to IEC/EN 60947-5-2.		<b>MS12A</b>
<b>M12A5</b> 	LS-Titan metal bodies (LSM-_)	Plug connector, 12 mm, 5-pin male connector (M12x1). Rated IP65. Molded material. Color coded to IEC/EN 60947-5-2.		<b>MS12A5</b>
<b>M22-LS</b> 	Any	Allows mounting of M22 pushbuttons. (See the M22 catalog, CA04716001E, for a full selection of pushbuttons.)	—	<b>M22-LS</b>

## Technical Data and Specifications

### LS-Titan Miniature DIN Switches—IP66, IP67 Complete Units

Units			LS, LSM	LSE-11/LSE-02	LSE-AI ①	LSE-AU ①
<b>General</b>						
Standards			IEC/EN 60947	IEC/EN 60947 EN 61000-4	IEC/EN 60947 EN 61000-4	IEC/EN 60947 EN 61000-4
Climatic proofing			Damp heat, constant, to IEC 60068-2-78; damp heat, cyclical, to IEC 60068-2-30	Damp heat, constant, to IEC 60068-2-78; damp heat, cyclical, to IEC 60068-2-30	Damp heat, constant, to IEC 60068-2-78; damp heat, cyclical, to IEC 60068-2-30	Damp heat, constant, to IEC 60068-2-78; damp heat, cyclical, to IEC 60068-2-30
Ambient temperature	°F (°C)		−13° to 158°F (−25° to 70°C)	−13° to 158°F (−25° to 70°C)	−13° to 158°F (−25° to 70°C)	−13° to 158°F (−25° to 70°C)
Mounting position			As required	As required	As required	As required
Protection type			IP66, IP67	IP66, IP67	IP66, IP67	IP66, IP67
Terminal capacity of screw terminal and Cage Clamp						
Solid	mm <sup>2</sup>		1 x (0.5–2.5)	1 x (0.5–2.5)	1 x (0.5–2.5)	1 x (0.5–2.5)
Flexible with ferrules to DIN 46228	mm <sup>2</sup>		1 x (0.5–1.5)	1 x (0.5–1.5)	1 x (0.5–1.5)	1 x (0.5–1.5)
<b>Power Supply</b>						
Rated voltage	U <sub>e</sub>	Vdc	N/A	12–30	24 (−15%/+20%)	24 (−15%/+20%)
Burden current						
12V	I <sub>e</sub>	mA	N/A	15	N/A	N/A
24V	I <sub>e</sub>	mA	N/A	18	28–45	24
30V	I	mA	N/A	19	N/A	N/A
<b>Contacts/Switching Capacity</b>						
Rated impulse withstand voltage	U <sub>imp</sub>	Vac	4000	N/A	N/A	N/A
Rated insulation voltage	U <sub>i</sub>	V	400	N/A	N/A	N/A
Overvoltage category/ pollution degree			III/3	III/3	N/A	N/A
<b>Rated Operational Current</b>						
AC-15						
24V	I <sub>e</sub>	A	6	N/A	N/A	N/A
230V/240V	I <sub>e</sub>	A	6	N/A	N/A	N/A
400V/415V	I <sub>e</sub>	A	4	N/A	N/A	N/A
DC-13						
24V	I <sub>e</sub>	A	3	0.2	N/A	N/A
110V	I <sub>e</sub>	A	0.8	N/A	N/A	N/A
220V	I <sub>e</sub>	A	0.3	N/A	N/A	N/A

#### Note

① The following applies for LSE-11 and LSE-02: ensure that the power supply operates correctly when setting the operating point.

## LS-Titan Miniature DIN Switches—IP66, IP67 Complete Units. continued

	Units	LS, LSM	LSE-11/LSE-02	LSE-AI ①	LSE-AU ①
<b>Burden Current</b>					
Analog output Q1					
Output voltage (max. 10 mA)	Vdc	N/A	N/A		0–10
Output current	mA	N/A	N/A	4–20	
Fault scenario	V	N/A	N/A	0	0
Resolution	Steps	N/A	N/A	100	100
Step tolerance	Steps	N/A	N/A	1	1
Shunt resistor, resistive load	ohms	N/A	N/A	<400	>1000
Digital diagnostics output Q2 (switching to + pole PNP)					
Response threshold	V	N/A	N/A	Approx. $U_e$	Approx. $U_e$
	mA	N/A	N/A	<200	<200
Control circuit reliability					
At 24 Vdc/5 mA	$H_F$	Fault probability	$<10^{-7}$ , <1 fault in $10^7$ operations	N/A	N/A
At 5 Vdc/1 mA	$H_F$	Fault probability	$<10^{-6}$ , <1 failure at $5 \times 10^6$ operations	N/A	N/A
Supply frequency	Hz	Max. 400	N/A	N/A	N/A
Short-circuit rating to IEC/EN 60947-5-1					
Maximum fuse	A gG/gL	6	N/A	N/A	N/A
Repetition accuracy	mm	$\pm 0.02$	$\pm 0.02$	$\pm 0.02$	$\pm 0.02$

**Note**

① The following applies for LSE-11 and LSE-02: ensure that the power supply operates correctly when setting the operating point.



## LS-Titan Miniature DIN Switches—IP66, IP67 Complete Units

	Units	LS, LSM		LSE-11/LSE-02	LSE-AI/LSE-AU	LSE-AI/LSE-AU
<b>Mechanical Variables</b>						
Lifespan						
Standard-action contact	Operations	X 10 <sup>6</sup>	8	N/A	N/A	N/A
Snap-action contact	Operations	X 10 <sup>6</sup>	8	3 (electronic)	N/A	N/A
Contact temperature of roller head		°C	≤100	≤100	≤100	≤100
Mechanical shock resistance (half-sinusoidal shock, 20 ms)						
Standard-action contact		g	25	N/A	N/A	N/A
Snap-action contact		g	N/A	N/A	N/A	N/A
Basic unit		g	N/A	30	30	30
Operating frequency	Operations/h		≤6000	≤3000	≤3000	≤3000
Switching point			N/A	0.5–5.5 mm freely adjustable	N/A	N/A
Hysteresis		mm	N/A	0.4	0.4	0.4
Contact sequence (contact closed open Zw = positive opening clearance)		mm	N/A	0.04	0.06	0.06
<b>Actuation</b>						
Mechanical						
Actuating force at beginning/end of stroke						
Basic units		N	1.0/8.0	3.5/8.0	3.5/8.0	3.5/8.0
LS(M)-XP		N	1.0/8.0	1.0/8.0	1.0/8.0	1.0/8.0
LS(M)-XL		N	1.0/8.0	1.0/8.0	1.0/8.0	1.0/8.0
LS(M)-XLA		N	1.0/8.0	1.0/8.0	1.0/8.0	1.0/8.0
Actuating torque of rotary drives		Nm	0.2	0.2	0.2	0.2
Maximum operating speed with DIN cam						
Basic units for angle of actuation	$\alpha = 0^\circ/30^\circ$	m/s	1/0.5	1/0.5	1/0.5	1/0.5
LS(M)-XRL for angle of actuation	$\alpha = 0^\circ$	m/s	1.5	1.5	1.5	1.5
LS(M)-XRLA for angle of actuation	$\alpha = 30^\circ, L = 125 \text{ mm}$	m/s	1.5	1.5	1.5	1.5
LS(M)-XRR for angle of actuation	$L = 130 \text{ mm}$	m/s	1.5	1.5	1.5	1.5
LS(M)-XL for angle of actuation	$\alpha = 30^\circ/45^\circ$	m/s	1	1	1	1
LS(M)-XLA for angle of actuation	$\alpha = 30^\circ/45^\circ$	m/s	1	1	1	1
LS(M)-XP for angle of actuation	$\alpha = 0^\circ/30^\circ$	m/s	1/1	1/1	1/1	1/1
<b>Electromagnetic Compatibility (EMC)</b>						
Electrostatic discharge (IEC/EN 61000-4-2, Level 3 ESD)						
Air discharge		kV		8	8	8
Contact discharge		kV		4	4	4
Electromagnetic fields (IEC/EN 61000-403, RFI)		V/m		10	10	10
Burst pulses (IEC/EN 61000-4-4, Level 3)						
Supply cables		kV		2	2	2
Signal lines		kV		2	2	2
High-energy pulses (surge) (IEC/EN 61000-4-5)		kV		0.5	0.5	0.5
Immunity to line-conducted interference to (IEC/EN 610000-4-6)		V		10	10	10

#### Contact Travel Diagrams

#### LSE

46

Description	Contact Travel	LSE-11	LSE-02
	■ = contact closed □ = contact open		
<b>Basic Units</b>			
<b>Operating Heads</b>			
Roller plunger			
LS-XP LSM-XP			
Roller lever			
LS-XL LSM-XL LS-XL LS-XLB			
Angled roller lever			
LS-XLA LSM-XLA			
Rotary lever			
LS-XRL LSM-XRL			
Adjustable roller lever			
LS-XRLA LSM-XRLA LS-XRLA30 LS-XRLA40 LS-XRLA40R			
Actuating rod			
LS-XRR LSM-XRR LS-XRRM LSM-XRRM			
Spring rod			
LS-XS LSM-XS			

### LS and LSM

**Contact Travel**  
 ■ = contact closed  
 □ = contact open

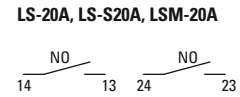
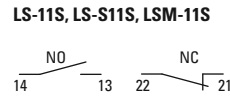
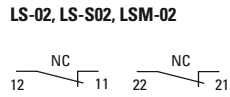

**Description**

**Basic Units**

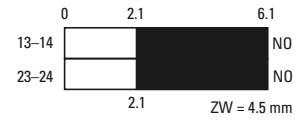
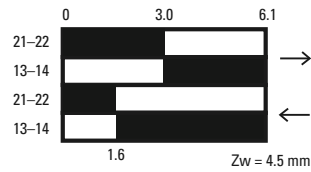
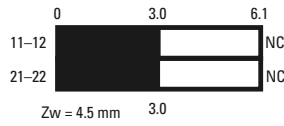

**Operating Heads**

**Roller plunger**

LS-XP, LSM-XP

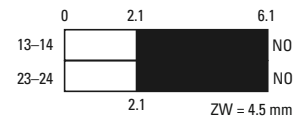
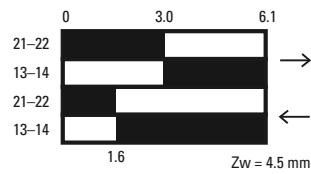
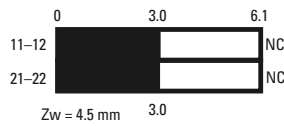

**Roller lever**

LS-XL, LSM-XL

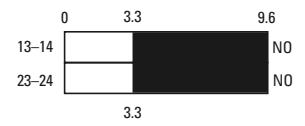
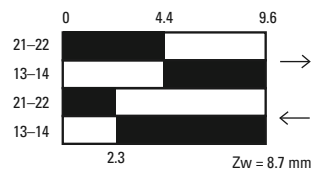
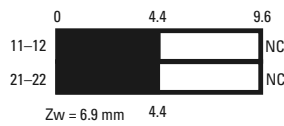

**Roller lever, short**

LS-XLS

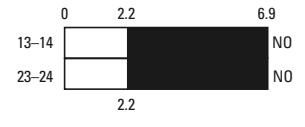
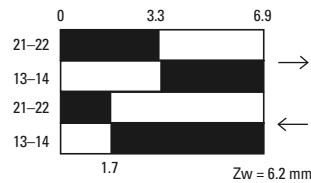
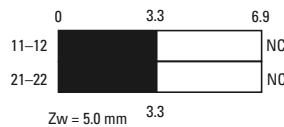

**Roller lever, large**

LS-XLB

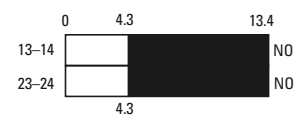
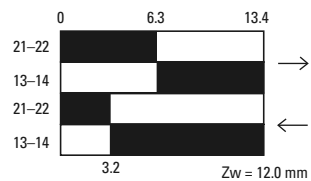
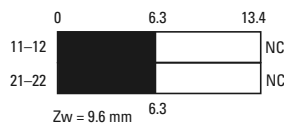

# 46.3

## Limit Switches

### LS-Titan Miniature DIN Switches

46

#### LS and LSM, continued

**Contact Travel**

■ = contact closed  
□ = contact open

**LS-02, LS-S02, LSM-02**

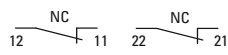

**LS-11S, LS-S11S, LSM-11S**

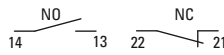

**LS-20A, LS-S20A, LSM-20A**

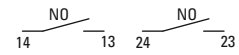

**Description**

**Operating Heads, continued**

Angled roller lever

LS-XLA, LSM-XLA

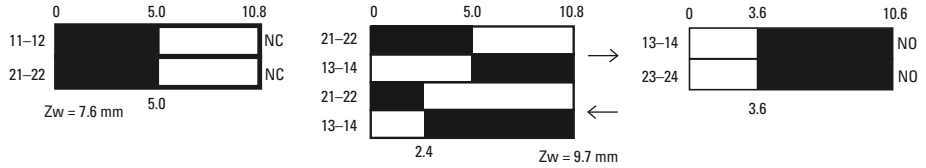

Rotary lever

LS-XRL, LSM-XRL

Adjustable roller lever

LS-XRLA, LSM-XRLA  
LS-XRLA30, LS-XRLA40  
LS-XRLA40R

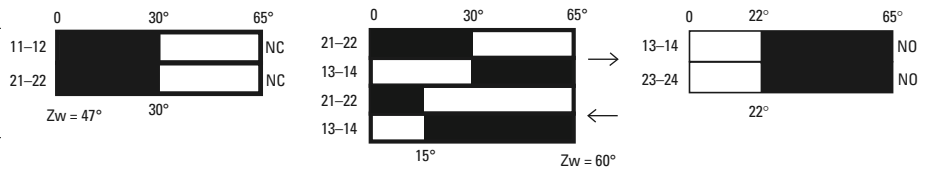

Actuating rod

LS-XRR, LSM-XRR  
LS-XRRM, LSM-XRRM

Spring rod

LS-XS, LSM-XS

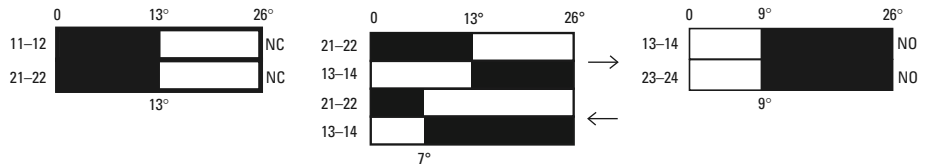

**Dimensions**

Approximate Dimensions in Inches (mm)

**Position Switches**

**LS-, LSM-, LSE-**

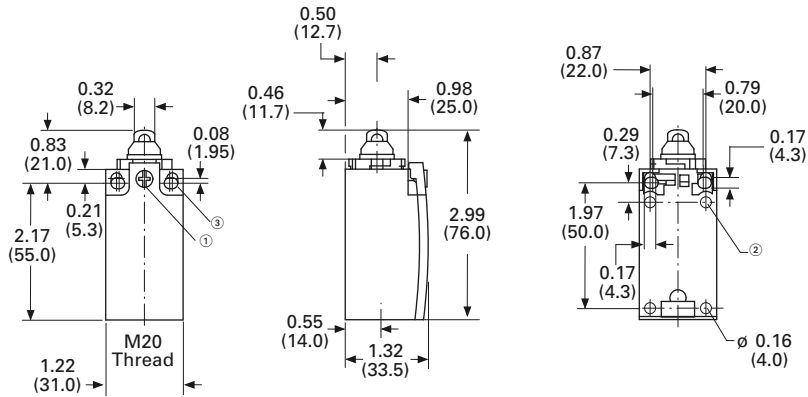

**LS-, LSM-, LSE-**

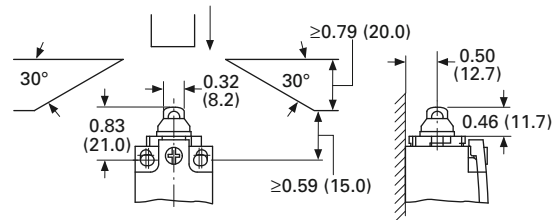

**LS(M)-/S**

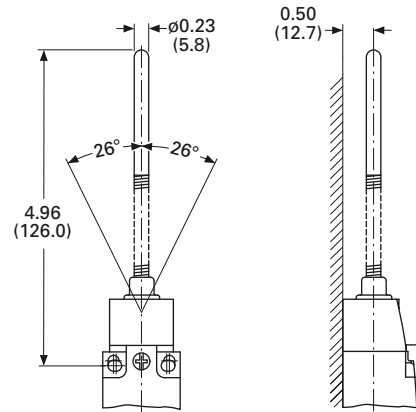

**LS(M)-/P**

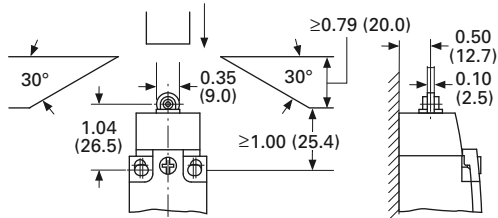

**Notes**

- ① Tightening torque of cover screws: 0.8 Nm  $\pm$  0.2 Nm.
- ② Only with LS (insulated version).
- ③ Fixing screws 2 x M4  $\geq$  30  
M<sub>A</sub> = 1.5 Nm

# 46.3

## Limit Switches

### LS-Titan Miniature DIN Switches

Approximate Dimensions in Inches (mm)

46

#### Rotary Lever

LS(M)-\_/RL

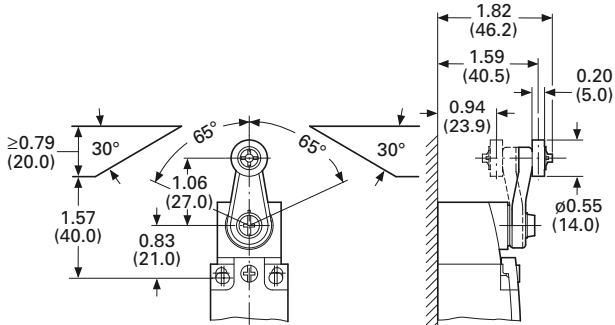

#### Roller Lever, Short

LS(M)-\_/LS

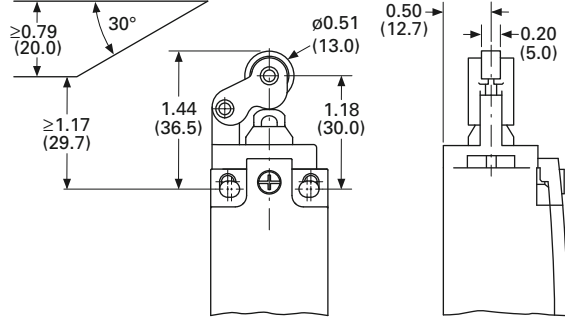

#### Roller Lever

LS(M)-\_/L

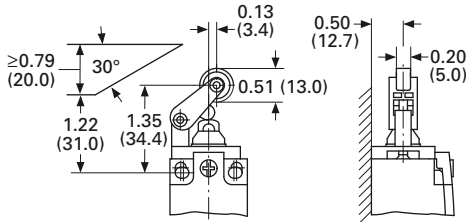

#### Adjustable Roller Lever

LS(M)-\_/RLA

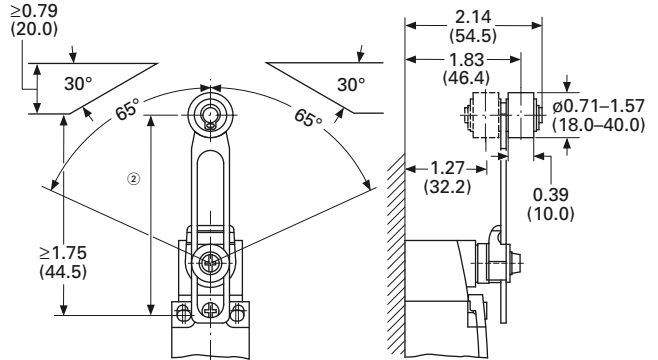

#### Roller Lever, Large

LS(M)-\_/LB ①

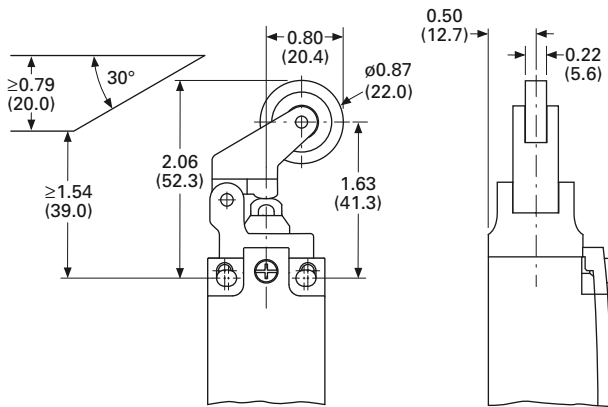

#### Angled Roller Lever

LS(M)-\_/XLA

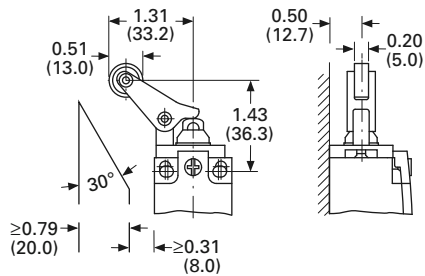

#### Notes

- ① Tightening torque of cover screws: 0.8 Nm ±0.2 Nm.
- ② Setting range of 54.5 to 97.

Approximate Dimensions in Inches (mm)

**Actuating Rod**

**LS(M)-\_/RR**

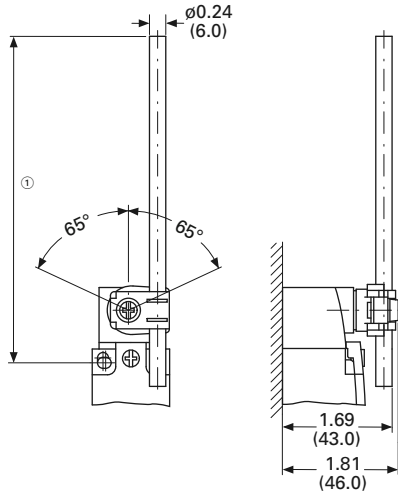

**LS(M)-\_/OR**

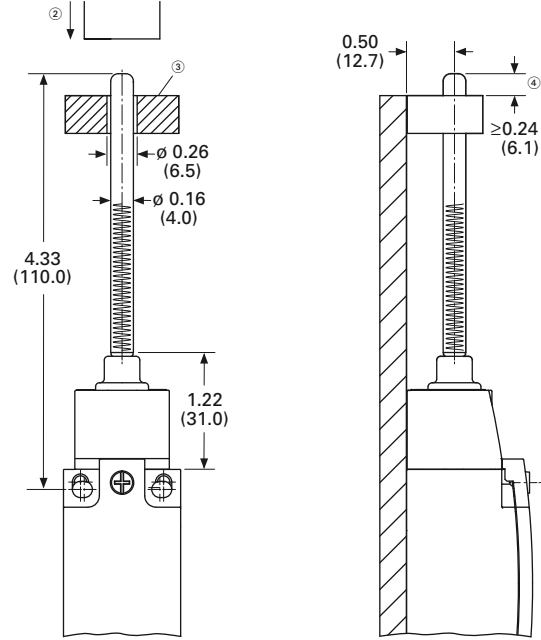

**Notes**

- ① LS\_/RR ≤150  
LS\_/RRM ≤210
- ② Approach direction, vertical.
- ③ Guide is done by customer, not included.
- ④ Maximum push-through.

LS-Titan Safety Interlock Switches



### LS-Titan Safety Interlock Switches

#### Product Description

Eaton's LS-Titan™ safety interlock switches have been specifically designed for monitoring the position of protective guards, such as doors, flaps, hoods and grilles. All switches in this family are safety-rated, include positively opening NC contacts, and cannot be defeated using simple tools, such as pliers, screwdrivers and nails.

The LS-Titan safety interlock family is comprised of three types of safety switches: key interlock, door-flap and door-hinge switches.

Key interlock switches are a two-piece design, made up of the switch and key (actuator). The key portion of the switch is affixed to a movable door, cover or other such guard. The switch itself is mounted to a rigid portion of the machine. When the guard is opened, the key is removed from the switch, thereby positively breaking the NC contacts. This interrupts the control circuit, stopping machine operation.

The door-flap and door-hinge switches are one-piece designs, suitable for when a key cannot be mounted in the application. When an attempt is made to open a protected door hinge or flap during operation, these switches disconnect the power supply to the machine or installation. Both switches feature four-way adjustable heads.

All LS-Titan safety interlock switches are approved to protect personnel and processes.

### Contents

<i>Description</i>	<i>Page</i>
LS-Titan Safety Interlock Switches	
Product Identification . . . . .	25
Product Selection	
LS-Titan Miniature DIN Safety Interlock Switches . . . . .	26
LS-Titan Full-Size DIN Safety Interlock Switches . . . . .	27
LS-Titan Solenoid Safety Interlock Switches . . . . .	27
LS-Titan Solenoid Safety Interlock Keys . . . . .	28
Technical Data and Specifications . . . . .	29
Mounting Instructions . . . . .	30
Dimensions . . . . .	31

#### Features

- Broad family of safety interlock switches in industry-standard enclosure sizes: miniature DIN; full-size DIN; and larger, solenoid key interlocks providing the highest degree of personnel and process protection
- Large selection of actuators (keys), including those for sliding doors, swing doors and doors that do not close precisely
- Miniature DIN models have a five-way adjustable head, while full-size DIN models have four-way adjustable heads
- Fully safety-rated as interlocking devices per EN 1088, with safety function by positive opening contacts per IEC/EN 60947-5-1
- Door-flap and door-hinge safety switches provide a unique solution when actuators (keys) cannot be used
- IP65 degree of protection

#### Standards and Certifications

- UL® listed
- CSA® approved
- CCC



- Positive opening NC contacts per EN 60947-5-1



#### Safety Notes

**Do not use as a mechanical stop/shipping brace.**

**Any change to an original Eaton safety position switch is not permitted and automatically leads to the loss of all approvals.**

**⚠ Switch must never be used as a mechanical stop.**

For the most current information on this product, visit our web site: [www.eaton.com](http://www.eaton.com)



**Product Identification**

**Solenoid Safety Interlock Switches (LS-...ZBZ)**

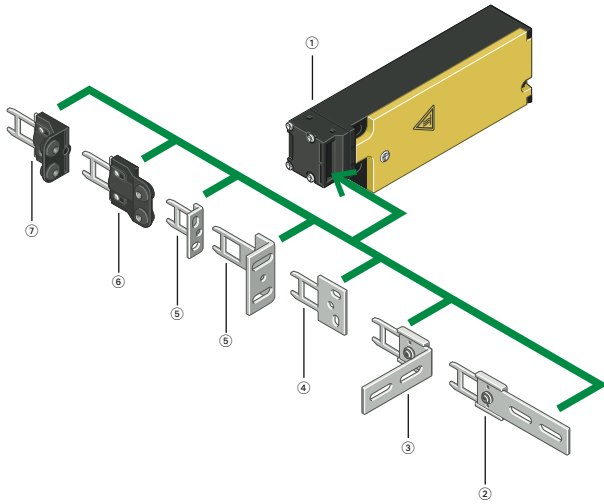

**Notes**

- ① **Basic device** (see Page 27)  
Spring or magnet-powered interlock  
For increased personnel and process protection  
Tamper-proof  
Multiple coded actuators  
Contacts: 1NO-1NC or 2NC
- ② **Flat flexible actuator** (see Page 28)  
For doors that do not close precisely
- ③ **Angled flexible actuator** (see Page 28)  
For doors that do not close precisely
- ④ **Flat actuator** (see Page 28)  
For sliding doors
- ⑤ **Angled actuator** (see Page 28)  
For swing doors
- ⑥ **Flat compensating actuator** (see Page 28)  
For increased tolerance compensation in the direction of door closure
- ⑦ **Angled compensating actuator** (see Page 28)  
For increased tolerance compensation in the direction of door closure

**Miniature DIN Safety Interlock Switch (LS-...ZB)**

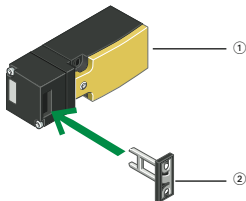

**Notes**

- ① **Complete device** (see Page 26)  
For personnel protection  
Contacts: 1NC, 1NO-1NO or 2NC  
Five directions of operation possible
- ② **Actuator** (see Page 26)  
Included with switch  
Multiple coding protection against tampering

**Door Flap Safety Switch (LSR-...TKG)**

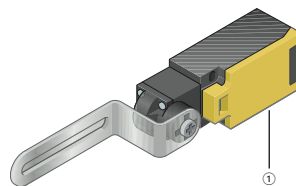

**Note**

- ① **Complete device** (see Page 26)  
For personnel protection  
Contacts: 1NO-1NC or 2NC  
For swing doors with fixed connection to the door/hinge pin

**Door Hinge Safety Switch (LSR-...TS)**

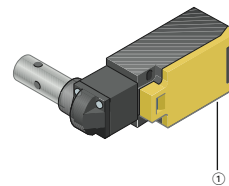

**Note**

- ① **Complete device** (see Page 26)  
For personnel protection  
Contacts: 1NO-1NC or 2NC  
For swing doors with fixed connection to the door/hinge pin

**Full-Size DIN Safety Interlock Switch (LS4-...ZB)**

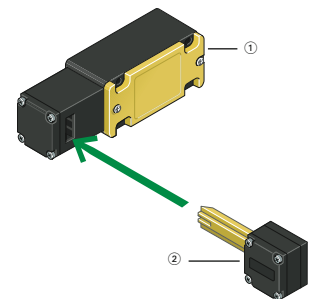

**Notes**

- ① **Complete device** (see Page 27)  
Narrow enclosure version  
For personnel protection  
Contacts: 1NO, 1NO-1NC
- ② **Actuator**  
Included with switch, not orderable as a separate item  
Multiple coding  
For horizontal or vertical operation

#### Product Selection

#### LS-Titan Miniature DIN Safety Interlock Switches

##### Key Interlock Switch



##### Key Interlock Switch—LS-...ZB ①

Contacts	Contact Sequence	Contact Travel	Connection	Catalog Number (Includes Key)
2NC with positive opening		—	Screw terminal	<b>LS-S02-ZB</b>
1NO and 1NC with positive opening		—	Screw terminal	<b>LS-S11-ZB</b>
		Snap action contacts	Screw terminal	<b>LS-S11S-ZB</b>

##### Door-Flap Switch



##### Door-Flap Switch—LSR-...TKG ①

Contacts	Contact Sequence	Contact Travel	Connection	Catalog Number (Includes Key)
2NC with positive opening			Screw terminal	<b>LSR-S02-1-I-TKG</b>
1NO and 1NC with positive opening			Screw terminal	<b>LSR-S11-1-I-TKG</b>

##### Door-Hinge Switch



##### Door-Hinge Switch—LSR-...TS ①

Contacts	Contact Sequence	Contact Travel	Connection	Catalog Number (Includes Key)
2NC with positive opening			Screw terminal	<b>LSR-S02-1-I-TS</b>
1NO and 1NC with positive opening			Screw terminal	<b>LSR-S11-1-I-TS</b>

##### Replacement Safety Interlock Key

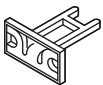

##### Replacement Safety Interlock Key ①

Description	Catalog Number
Replacement key for miniature DIN key interlock switches (only models LS-...ZB).	<b>LS-XB-ZB</b>

##### Note

① For dimensions, see **Page 31**.

**LS-Titan Full-Size DIN Safety Interlock Switches**

**Key Interlock Switch**

**Full-Size DIN—LS4...ZB** ①②



Contacts	Contact Sequence	Contact Travel	Connection	Catalog Number (Includes Key)
1NO and 1NC with positive opening		—	Screw terminal	<b>LS4-S11-1-I-ZB</b>

**LS-Titan Solenoid Safety Interlock Switches**

**Switch Body without Key**

**Switch Body without Key—LS...ZBZ** ①②③







Operation	Operating Voltage	Contacts	Contact Sequence	Catalog Number (Key not Included)
Power to unlock (mechanical bypass present)	24 Vdc	1NO and 1NC with positive opening		<b>LS-S11-24DFT-ZBZ-X</b>
		2NC with positive opening		<b>LS-S02-24DFT-ZBZ-X</b>
Power to lock (mechanical bypass present)	120 Vac (50/60 Hz)	1NO and 1NC with positive opening		<b>LS-S11-120AFT-ZBZ-X</b>
		2NC with positive opening		<b>LS-S02-120AFT-ZBZ-X</b>
Power to lock (mechanical bypass present)	24 Vdc	1NO and 1NC with positive opening		<b>LS-S11-24DMT-ZBZ-X</b>
		2NC with positive opening		<b>LS-S02-24DMT-ZBZ-X</b>
Power to lock (mechanical bypass present)	120 Vac (50/60 Hz)	1NO and 1NC with positive opening		<b>LS-S11-120AMT-ZBZ-X</b>
		2NC with positive opening		<b>LS-S02-120AMT-ZBZ-X</b>

**Notes**

- ① For dimensions, see **Page 31**.
- ② For mounting instructions, see **Page 30**.
- ③ Key ordered separately, see **Page 28**.

#### LS-Titan Solenoid Safety Interlock Keys

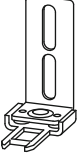
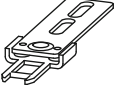
##### Keys Only—LS...ZBZ <sup>①②</sup>

	Description	Application	Catalog Number
<b>LS-XG-ZBZ</b> 	Flat actuator	For sliding doors	<b>LS-XG-ZBZ</b>
<b>LS-X...ZBZ</b> 	Angled actuator, short	For swing doors starting at 250 mm in width	<b>LS-XW-ZBZ</b>
	Angled actuator, long	For swing doors starting at 250 mm in width	<b>LS-XWA-ZBZ</b>
<b>LS-XF-ZBZ</b> 	Angled, flexible actuator	For doors that do not close precisely	<b>LS-XF-ZBZ</b>
<b>LS-XFG-ZBZ</b> 	Even, flexible coasting actuator	For doors that do not close precisely	<b>LS-XFG-ZBZ</b>
<b>LS-XNG-ZBZ</b> 	Flat, compensating actuator	Increased tolerance in closing direction for inaccurately closing doors	<b>LS-XNG-ZBZ</b>
<b>LS-XNW-ZBZ</b> 	Angled, compensating actuator	Increased tolerance in closing direction for inaccurately closing doors	<b>LS-XNW-ZBZ</b>

#### Notes

- ① Switch body ordered separately, see **Page 27**.
- ② For mounting instructions, see **Page 30**.

## Technical Data and Specifications

## LS-Titan Safety Interlock Switches

	Units		LS-...ZBZ	LS-...ZB	LS4...ZB
<b>General</b>					
Standards			IEC/EN 60947	IEC/EN 60947	IEC/EN 60947
Climatic proofing			①	①	①
Ambient temperature	°C		-25... +0	-25... +70	-25... +70
Mounting position			As required	As required	As required
Protection type			IP65	IP65	IP65
Terminal capacities					
Solid	mm <sup>2</sup>		1 x (0.75-2.5)/2 x (0.75-1.5)	1 x (0.75-2.5)/2 x (0.75-1.5)	1 x (0.75-2.5)/2 x (0.75-1.5)
Flexible with ferrule	mm <sup>2</sup>		1 x (0.75-2.5)/2 x (0.75-1.5)	1 x (0.75-2.5)/2 x (0.75-1.5)	1 x (0.75-2.5)/2 x (0.75-1.5)
<b>Contacts/Switching Capacity</b>					
Rated impulse withstand voltage	U <sub>imp</sub>	Vac	4000	6000	6000
Rated insulation voltage	U <sub>i</sub>	V	400	500	500
Overvoltage category/pollution degree			III/3	III/3	III/3
<b>Burden Current</b>					
AC-15					
24V	I <sub>e</sub>	A	6	10	10
230V/240V	I <sub>e</sub>	A	6	6	6
400V/415V	I <sub>e</sub>	A	4	4	4
DC-13					
24V	I <sub>e</sub>	A	3	3	3
110V	I <sub>e</sub>	A	0.8	0.8	0.8
220V	I <sub>e</sub>	A	0.3	0.3	0.3
Supply frequency		Hz	max. 400	max. 400	max. 400
Short-circuit rating to IEC/EN 60947-5-1 Max. fuse		A gG/gL	6	6	6
Repetition accuracy		mm	± 0.02	± 0.02	± 0.02
<b>Mechanical Variables</b>					
Lifespan					
Standard-action contact	Operations	x 10 <sup>6</sup>	1	10	10
Snap-action contact	Operations	x 10 <sup>6</sup>	—	—	—
Mechanical shock resistance (half-sinusoidal shock, 20 ms)					
Standard-action contact		g	10	25	5
Snap-action contact		g	—	—	—
Operating frequency	Operations/h		≤ 800	≤ 1800	≤ 1800
<b>Actuation</b>					
Mechanical					
Actuating force at beginning/end of stroke					
ZB/ZBZ (push in/pull out)		N	25/15	10/5	15/20
Mechanical holding force according to GS-ET-19 (04/2004)					
XG, XW		N	1500	N/A	N/A
XFF, XNG, XWA		N	1300	N/A	N/A
XF		N	750	N/A	N/A
XNW		N	500	N/A	N/A
Electromechanical					
For magnet					
Power consumption					
at 120 Vac		VA	8	N/A	N/A
at 230 Vac		VA	11	N/A	N/A
at 24 Vdc		W	8	N/A	N/A
Pickup and dropout values		x U <sub>s</sub>	0.85-1.1	N/A	N/A
Magnet duty factor		% ED	100	N/A	N/A

**Note**

① Damp heat, constant, to IEC 60068-2-78; damp heat, cyclical, to IEC 60068-2-30.

# 45.1

## Safety Products

### LS-Titan Safety Interlock Switches

45

#### Mounting Instructions

##### LS-...ZB, TKG, TS

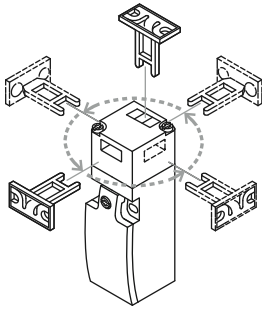

Actuator can be repositioned for horizontal or vertical installation. The operating heads can be rotated manually in 90° steps to suit the specified direction of operation.

##### LS4-...ZB

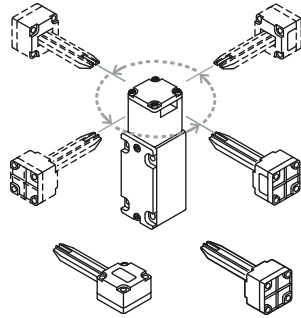

Actuator can be repositioned for horizontal or vertical installation. The operating heads can be rotated manually in 90° steps to suit the specified direction of operation.

##### LS-...ZBZ

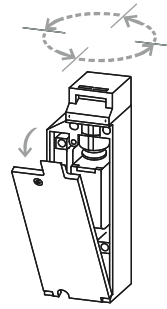

The operating head can be rotated manually in 90° steps to suit the specified level of actuation.

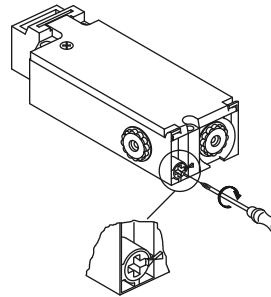

In the event of a loss of voltage, (e.g., during commissioning), the spring-powered LS-...-...FT-ZBZ can be released with a screwdriver. **The auxiliary release mechanism must be sealed.**

**Dimensions**

Approximate Dimensions in Inches (mm)

**Safety Position Switches**

**LS...ZB**

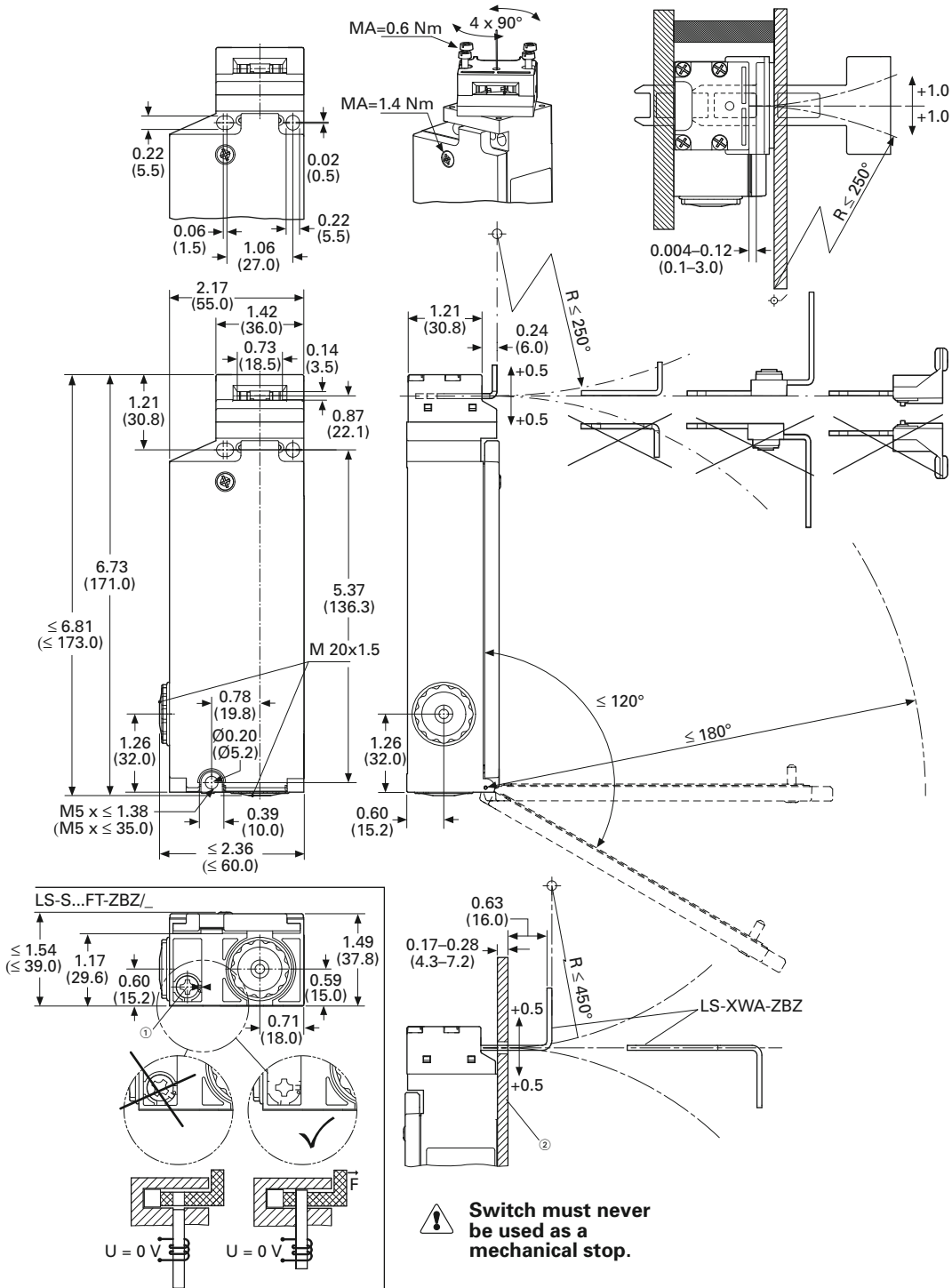

- Notes**
- ① The auxiliary release mechanism must be sealed for proper operation.
  - ② Can be used as stop with the corresponding material selection and design.

# 45.1

## Safety Products

### LS-Titan Safety Interlock Switches

45

Approximate Dimensions in Inches (mm)

#### Actuators

##### LS-XG-ZBZ

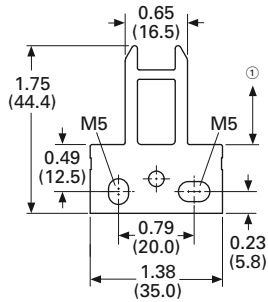

##### LS-XW-ZBZ

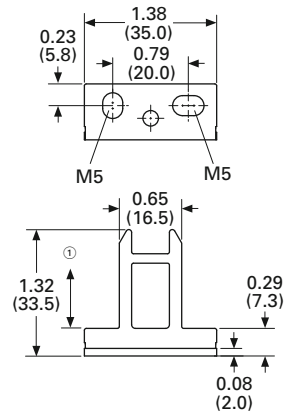

##### LS-XF-ZBZ

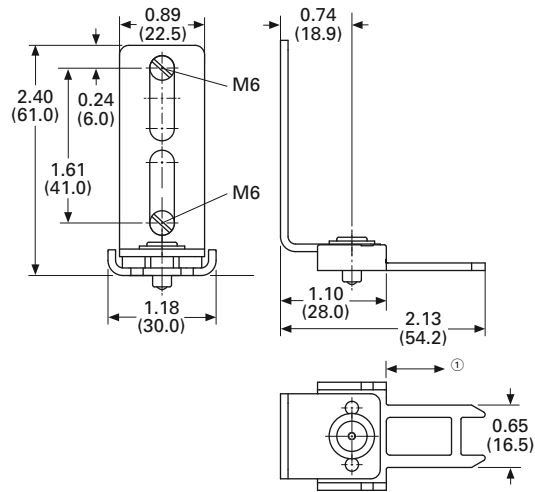

##### LS-XNW-ZBZ<sup>②</sup>

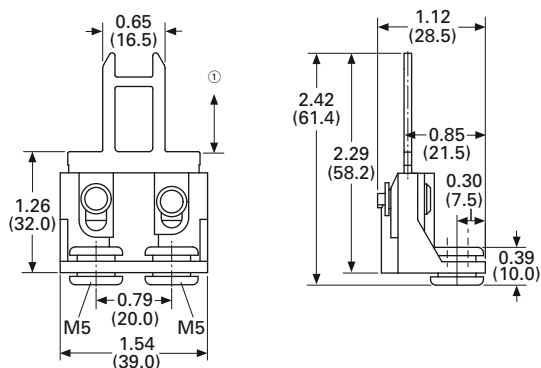

##### LS-XNG-ZBZ<sup>②</sup>

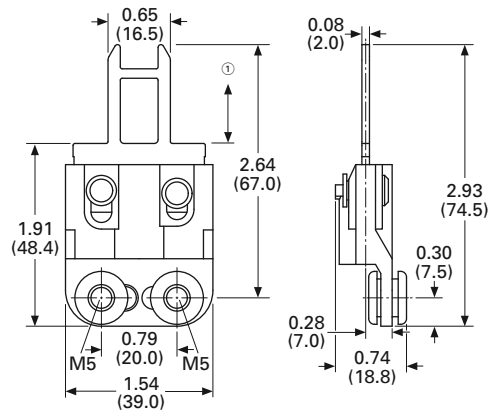

##### LS-XFG-ZBZ

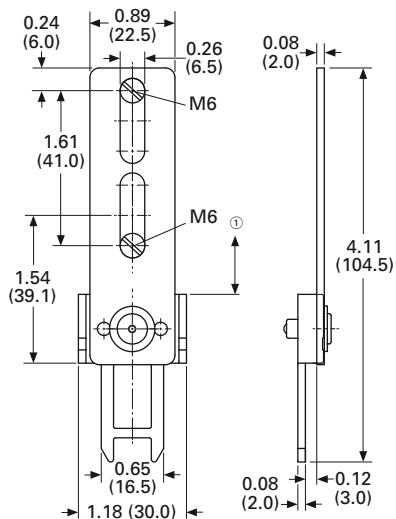

##### LS-XWA-ZBZ<sup>③</sup>

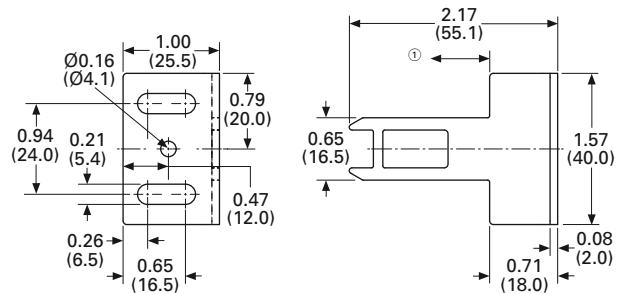

#### Notes

- ① Distance to device head = 0.1–3.0 mm.
- ② Fixing only allowed with M5 fixing screw and washer according to DIN EN ISO 7093.
- ③ Pin with a 4 mm pin after mounting.



Approximate Dimensions in Inches (mm)

### Safety Door Flap Switch

LSR-.../TKG

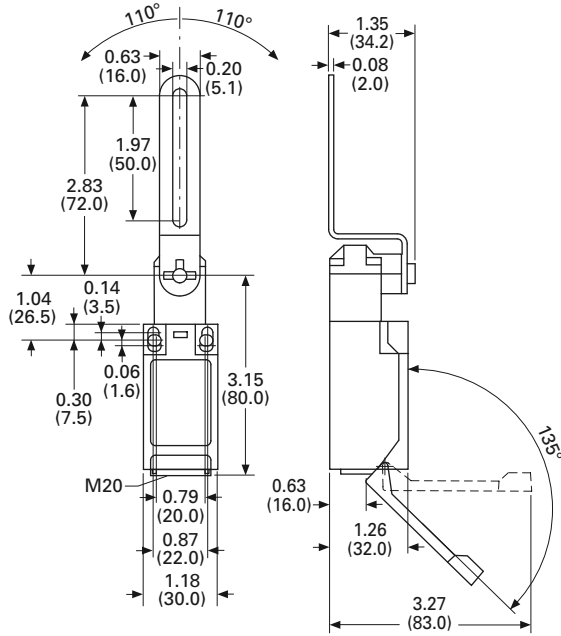

### Safety Hinge Switch

LSR-.../TS

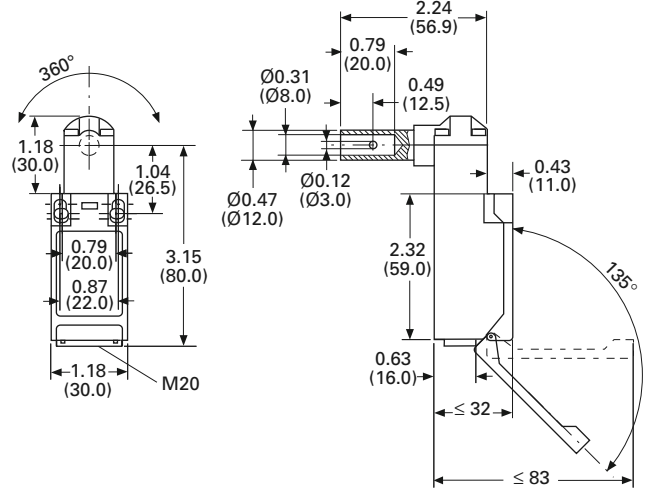

### Safety Position Switches

LS-...-ZB

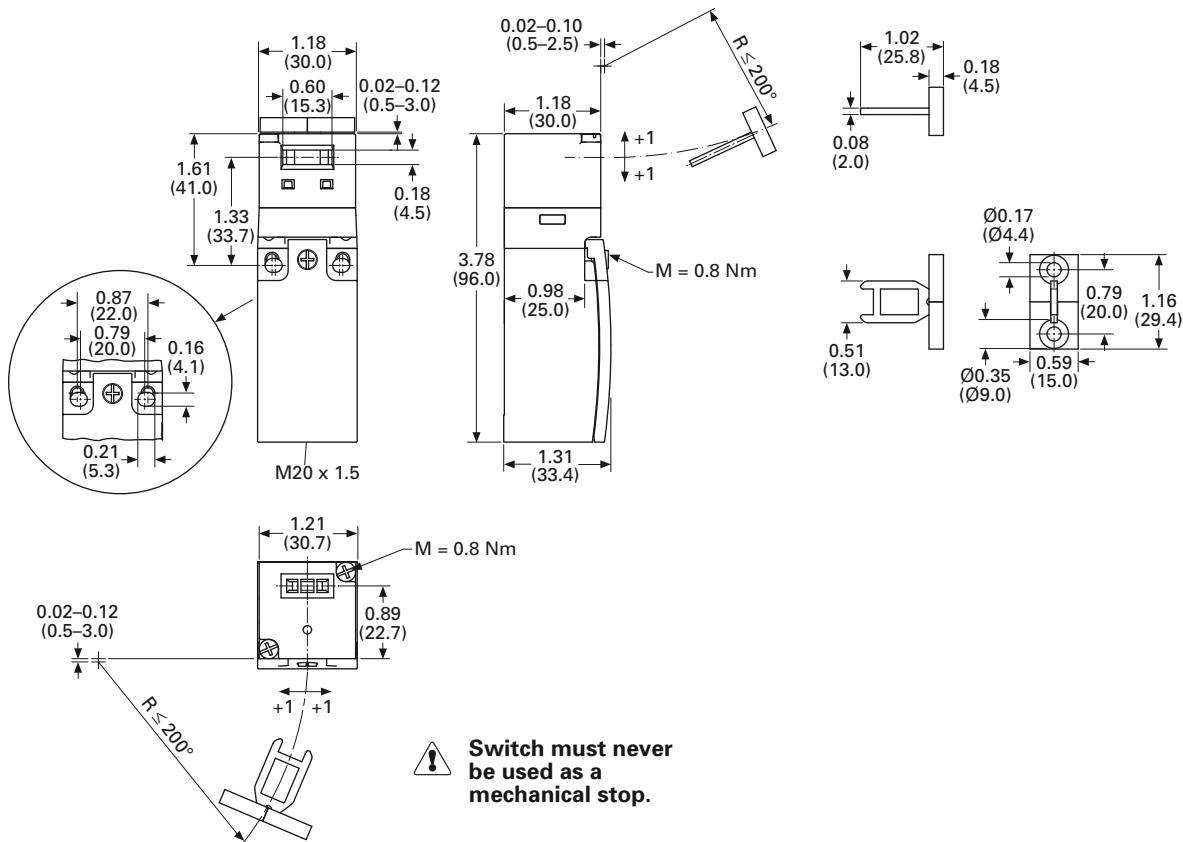

# 45.1

## Safety Products

### LS-Titan Safety Interlock Switches

45

Approximate Dimensions in Inches (mm)

#### Safety Position Switches

##### LS4...ZB

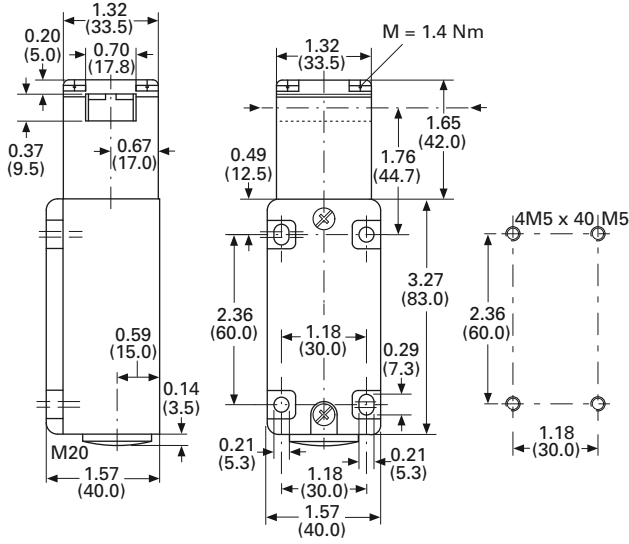

#### Actuator—Included with Switch Above

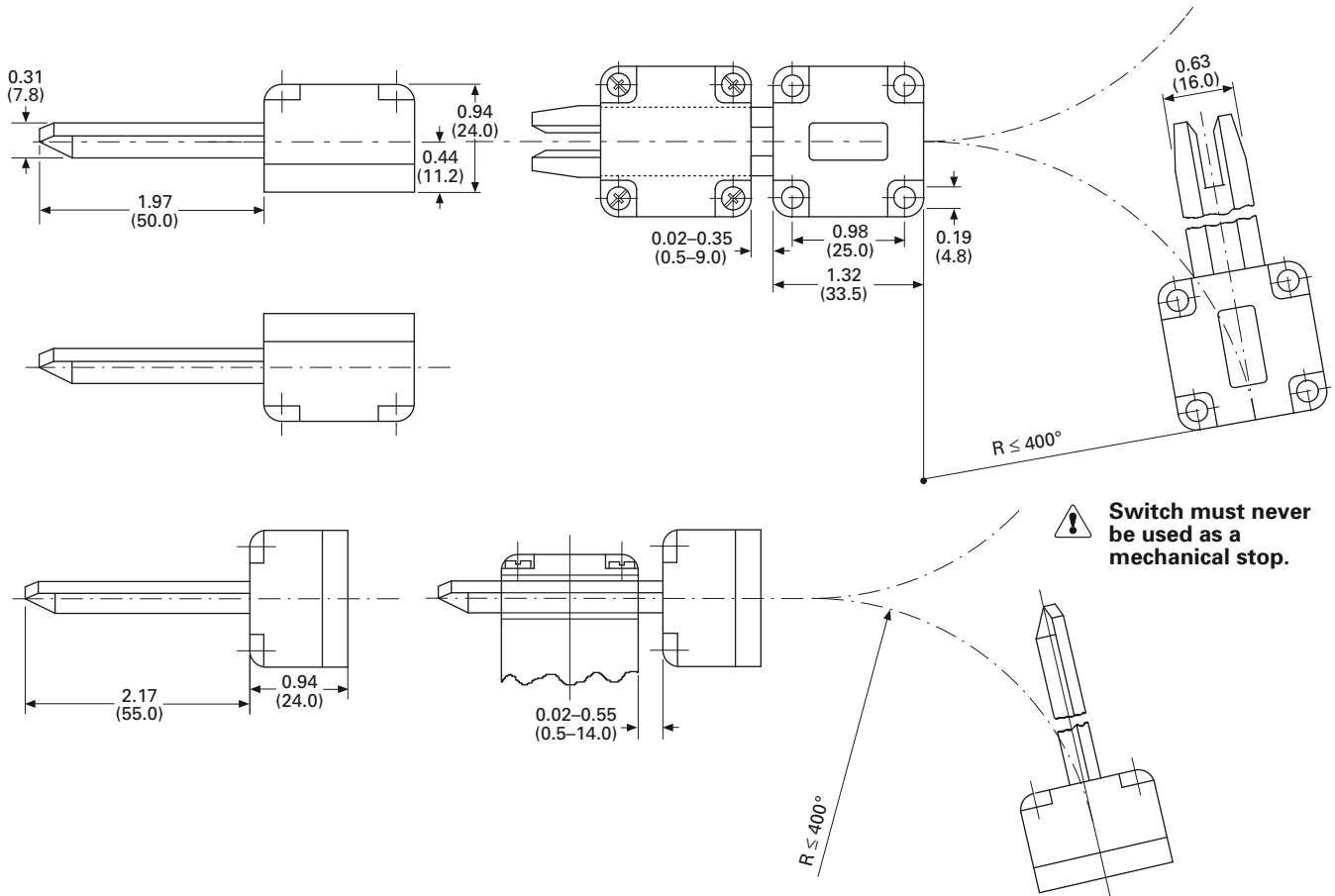



Eaton's Electrical Sector is a global leader in power distribution, power quality, control and automation, and monitoring products. When combined with Eaton's full-scale engineering services, these products provide customer-driven PowerChain™ solutions to serve the power system needs of the data center, industrial, institutional, public sector, utility, commercial, residential, IT, mission critical, alternative energy and OEM markets worldwide.

PowerChain solutions help enterprises achieve sustainable and competitive advantages through proactive management of the power system as a strategic, integrated asset throughout its life cycle, resulting in enhanced safety, greater reliability and energy efficiency. For more information, visit [www.eaton.com/electrical](http://www.eaton.com/electrical).

**Eaton Corporation**  
Electrical Sector  
1111 Superior Ave.  
Cleveland, OH 44114  
United States  
877-ETN-CARE (877-386-2273)  
[Eaton.com](http://Eaton.com)

©2011 Eaton Corporation  
All Rights Reserved  
Printed in USA  
Publication No. CA05208003E / Z10714  
January 2011



**PowerChain  
Management®**

PowerChain Management is a registered trademark of Eaton Corporation.

All other trademarks are property of their respective owners.

## X-ON Electronics

Largest Supplier of Electrical and Electronic Components

*Click to view similar products for [Basic / Snap Action Switches](#) category:*

*Click to view products by [Eaton](#) manufacturer:*

Other Similar products are found below :

[83228001](#) [01.098.1358.1](#) [602EN1-6B](#) [602EN532](#) [602EN535-RB](#) [602HE5-RB1](#) [604HE162](#) [604HE223-6B](#) [624HE17-RB](#) [6HM89](#) [6PA78-JM](#)  
[6SE1](#) [6SX1-H58](#) [70500840](#) [MBD5B1](#) [MBH2731](#) [73-316-0012](#) [79211759](#) [79211923](#) [79218589](#) [7AS12](#) [ML-1155](#) [ML-1376](#) [831010C3.0](#)  
[831060C3.TL](#) [831090C2.EL](#) [83131904](#) [84212012](#) [8AS239](#) [8HM73-3](#) [903VB1-PG](#) [914CE1-6G](#) [PL-100](#) [11SM1077-H4](#) [11SM1077-H58](#)  
[11SM1-TN107](#) [11SM405](#) [11SM703-T](#) [11SM8423-H2](#) [11SX37-T](#) [11SX48-H58](#) [11SX55-H58](#) [11SM2442-T](#) [11SM76-T](#) [11SM77-H58](#)  
[11SM77-T](#) [11SM863-T](#) [11SM866](#) [11SX47-H58](#) [A7CN-1M-1-LEFT](#)