

Data Sheet

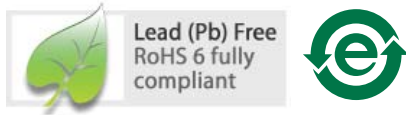

Description

This family of SMT LEDs is packaged in standard PLCC-4 package with additional heat sinking capability enabling it to be driven at even higher current. These SMT LEDs have high brightness and reliability performance and are designed to work under a wide range of environmental conditions. This high reliability feature makes them ideally suited to be used under exterior and interior full color signs application conditions.

To facilitate easy pick & place assembly, the LEDs are packed in EIA-compliant tape and reel. Every reel will be shipped in single intensity and color bin; except red color to provide close uniformity.

These LEDs are compatible with reflow soldering process.

This super wide viewing angle at 120° together with the built in reflector pushing up the intensity of the light output makes these LED suitable to be used in the interior electronics signs. The black top surface of the LED provides better contrast enhancement especially in the full color sign application.

Features

- PLCC-4 package (Plastic Leaded Chip Carrier) with additional heat sinking capability
- High reliability LED package with silicone encapsulation
- High brightness using AlInGaP and InGaN dice technologies
- Wide viewing angle at 120°
- Compatible with reflow soldering process
- JEDEC MSL 2a
- Water- Resistance (IPX6*) per IEC 60529:2001

* The test is conducted on component level by mounting the components on PCB with proper potting to protect the leads. It is strongly recommended that customers perform necessary tests on the components for their final application.

Applications

- Indoor and outdoor full color display

CAUTION: LEDs are Class 1C ESD sensitive. Please observe appropriate precautions during handling and processing. Please refer to Avago Application Note AN-1142 for additional details.

CAUTION: Customer is advised to keep the LED in the MBB when not in use as prolonged exposure to environment may cause the silver plated leads to tarnish and lead to difficulties in soldering.

Package Dimensions

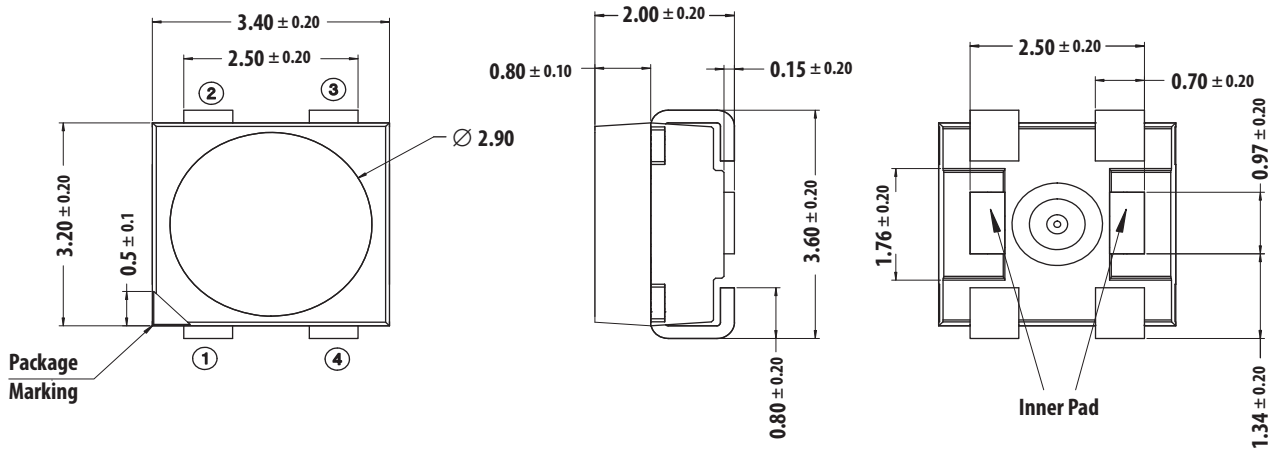

Notes:

1. All Dimensions are in millimeters
2. Tolerance = ± 0.2 mm unless otherwise specified
3. Terminal Finish: Ag plating

Lead Configuration

1	Cathode	Red
2	Common Anode	
3	Cathode	Blue
4	Cathode	Green

Note: Both inner pads is connected to common anode (pin2)

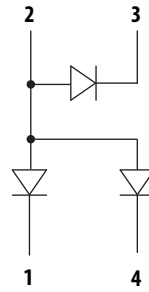

Circuit Diagram

Table 1. Device Selection Guide

Part Number	Color 1	Color 2	Color 3
ASMT-QTB4-0AA02	AllnGaP Red	InGaN Green	InGaN Blue

Part Number	Color 1- Red			Color 2- Green			Color 3- Blue		
	Bin ID	Min. I_V @ 20 mA (mcd)	Typ. I_V @ 20 mA (mcd)	Bin ID	Min. I_V @ 20 mA (mcd)	Typ. I_V @ 20 mA (mcd)	Bin ID	Min. I_V @ 20 mA (mcd)	Typ. I_V @ 20 mA (mcd)
ASMT-QTB4-0AA02	U1	450	620	V2	900	1200	S2	224	280

Notes:

1. The luminous intensity I_V is measured at the mechanical axis of the LED package. The actual peak of the spatial radiation pattern may not be aligned with this axis.
2. Tolerance = $\pm 12\%$.

Part Numbering System

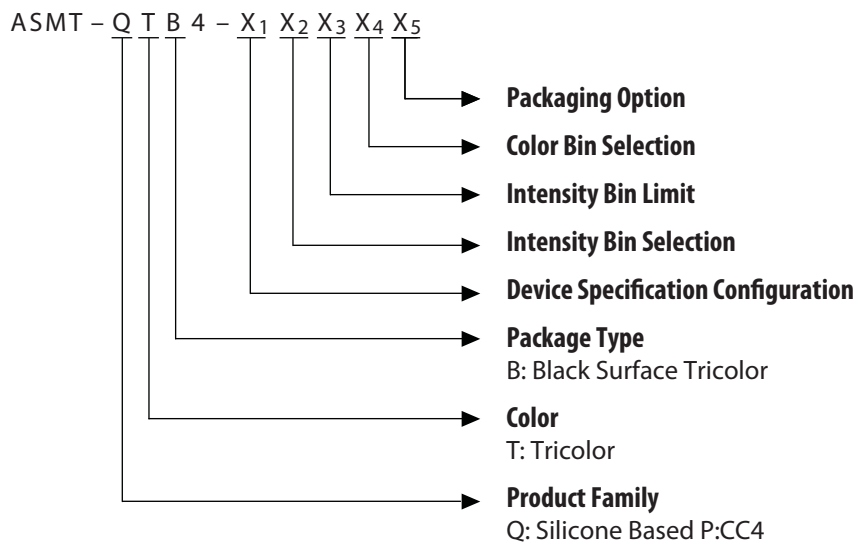

Table 2. Absolute Maximum Ratings ($T_A = 25^\circ\text{C}$)

Parameter	Red	Green & Blue	Unit
DC forward current ^[1]	50	30	mA
Peak forward current ^[2]	100	100	mA
Power dissipation	120	117	mW
Reverse voltage		4 ^[3]	V
Maximum junction temperature T_{jmax}		125	$^\circ\text{C}$
Operating temperature range		- 40 to + 110 ^[4]	$^\circ\text{C}$
Storage temperature range		- 40 to + 110	$^\circ\text{C}$

Notes:

1. Derate linearly as shown in Figure 5a & 5b.
2. Duty Factor = 0.5%, Frequency = 500Hz
3. Driving the LED in reverse bias condition is suitable for short term only
4. Refer to Figure 5a and figure 5b for more information

Table 3. Optical Characteristics ($T_A = 25^\circ\text{C}$)

Color	Dominant Wavelength, λ_d (nm) ^[1]			Peak Wavelength, λ_p (nm)	Viewing Angle $2\theta_{1/2}$ ^[2] (Degrees)	Luminous Efficacy η_V ^[3] (lm/W)
	Min	Typ.	Max	Typ.	Typ.	Typ.
Red	618	622	628	629	120	210
Green	525	530	537	521	120	535
Blue	465	470	477	464	120	84

Notes:

1. The dominant wavelength is derived from the CIE Chromaticity Diagram and represents the perceived color of the device.
2. $\theta_{1/2}$ is the off axis angle where the luminous intensity is $1/2$ the peak intensity
3. Radiant intensity, I_e in watts / steradian, may be calculated from the equation $I_e = I_V / \eta_V$, where I_V is the luminous intensity in candelas and η_V is the luminous efficacy in lumens / watt.

Table 4. Electrical Characteristics ($T_A = 25^\circ\text{C}$)

Color	Forward Voltage, V_F (V) ^[1]			Reverse Voltage V_R @ 100 μA	Reverse Voltage V_R @ 10 μA	Thermal Resistance $R_{\theta J-P}$
	Min	Typ.	Max.	Min.	Min.	Typ
Red	1.80	2.10	2.40	4	–	50
Green	2.80	3.20	3.80	–	4	95
Blue	2.80	3.20	3.80	–	4	95

Note:

1. Tolerance $\pm 0.1\text{V}$.

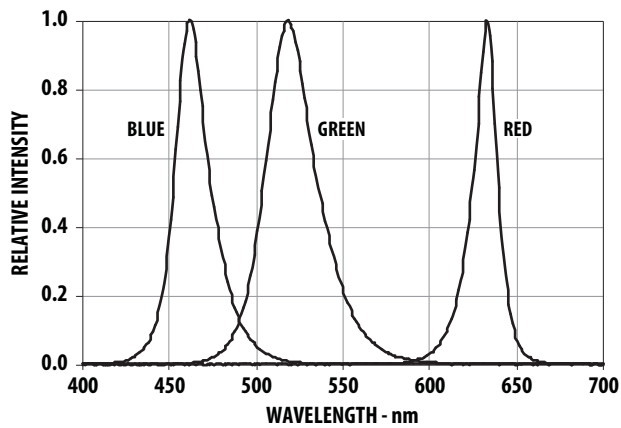

Figure 1. Relative intensity vs. wavelength

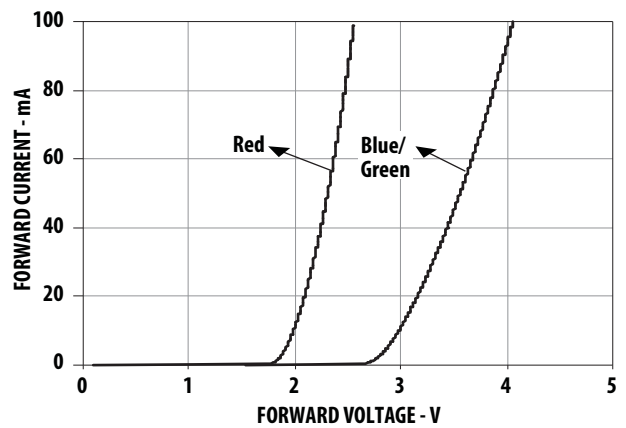

Figure 2. Forward Current-mA vs Forward Voltage-V

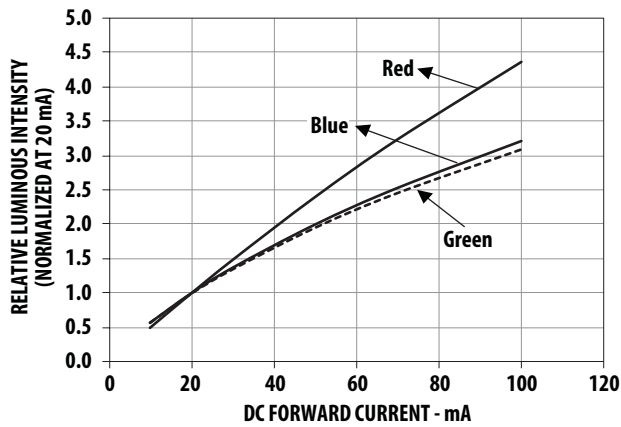

Figure 3. Relative Intensity vs Forward Current

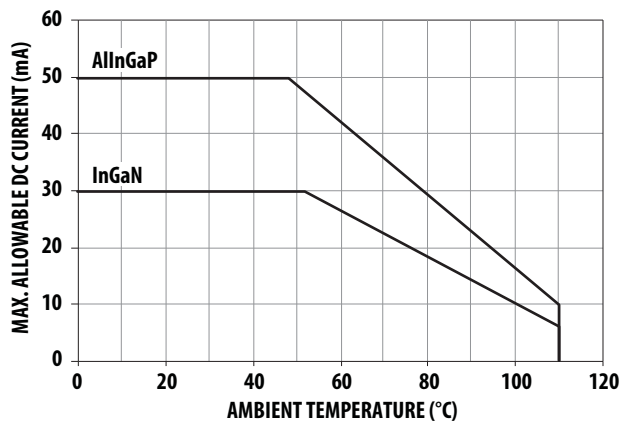

Figure 4a. Maximum forward current vs. ambient temperature. Derated based on $T_{jMAX} = 125^{\circ}C$. (3 chips)

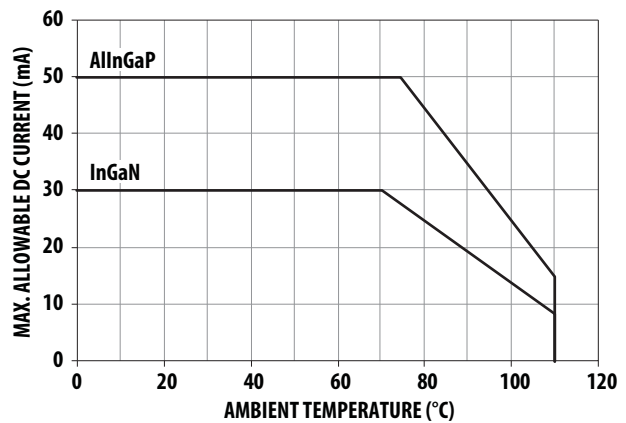

Figure 4b. Maximum forward current vs. ambient temperature. Derated based on $T_{jMAX} = 125^{\circ}C$. (single chip)

Note: Figure 4a & 4b is established based on four pins together with two inner pads were soldered on PCBs. Customer is advised to re-calculate the thermal resistance if two inner pads are not solder.

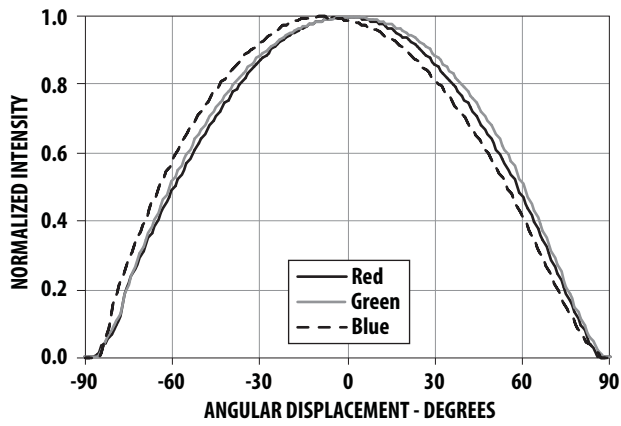

Figure 5. Radiation Pattern

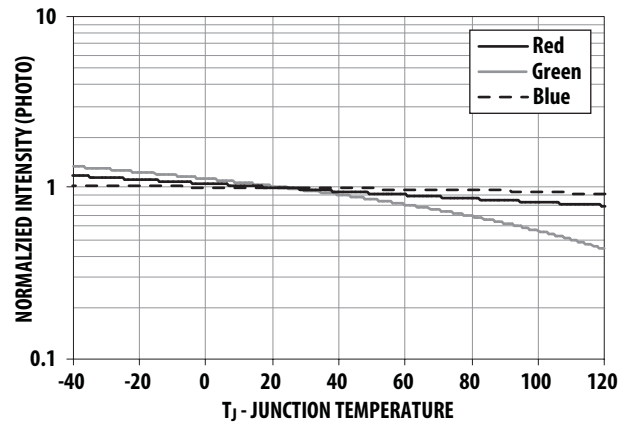

Figure 6. Relative Intensity vs Junction Temperature

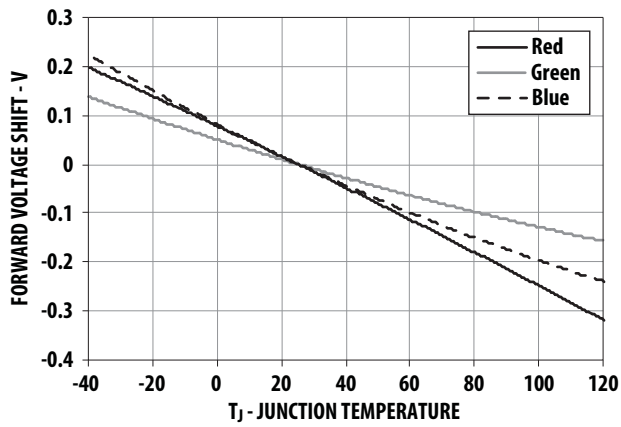

Figure 7. Relative Forward Voltage vs Junction Temperature

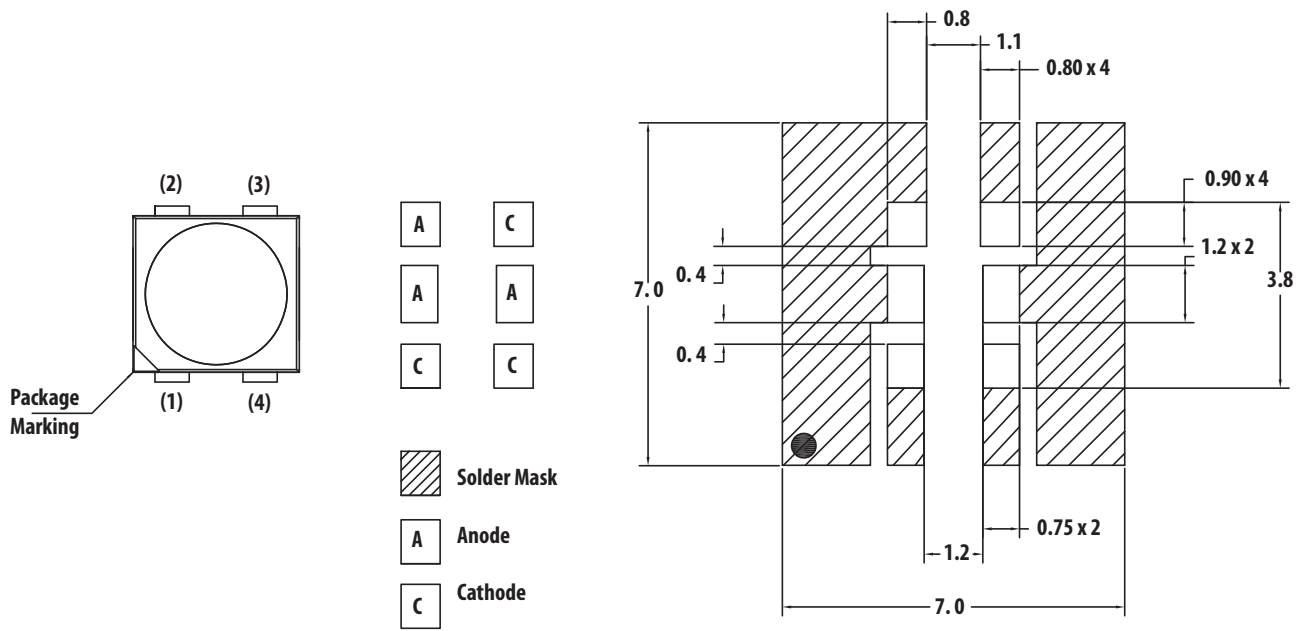

Figure 8. Recommended soldering land pattern.

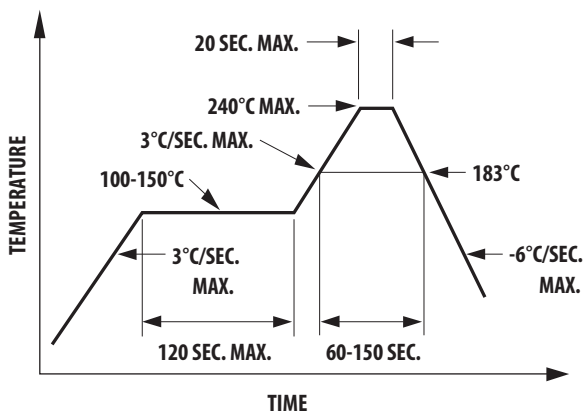

Figure 9. Recommended leaded reflow soldering profile.

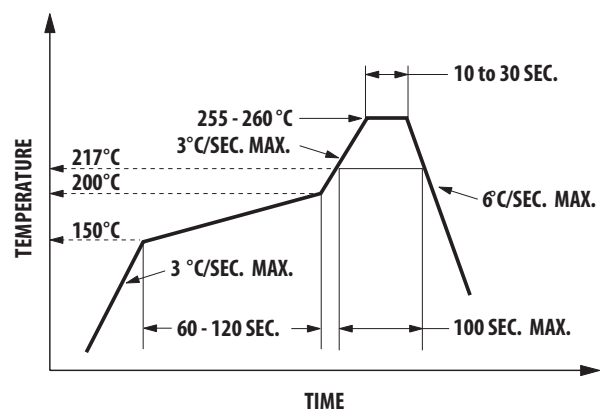

Figure 10. Recommended Pb-free reflow soldering profile.

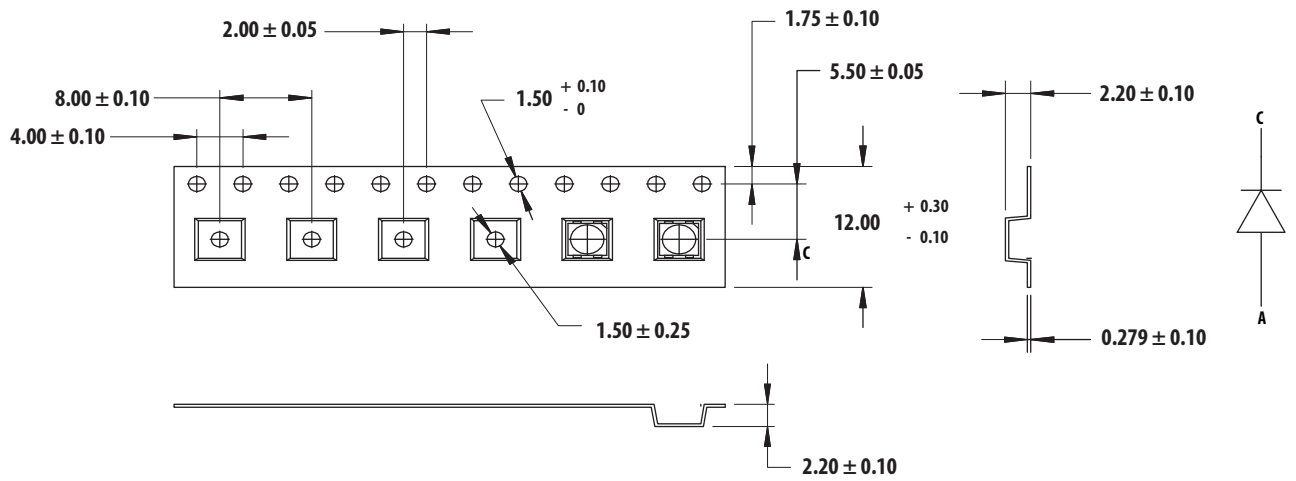

Figure 11. Carrier Tape Dimension

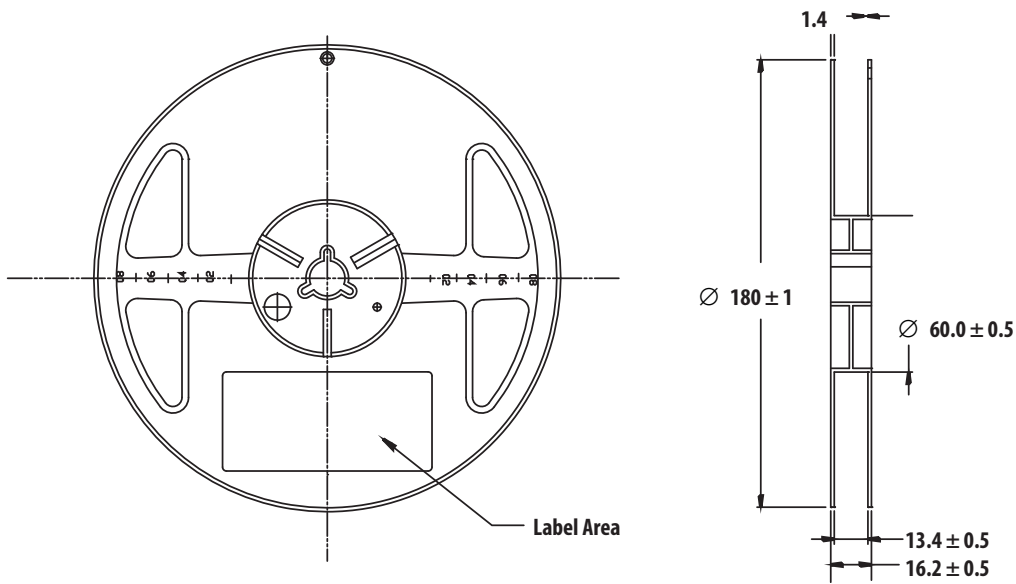

Figure 12. Reel Dimension

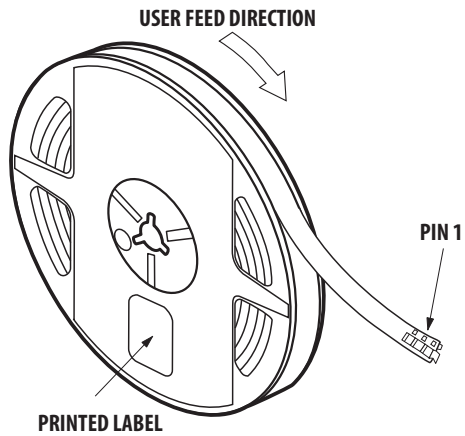













Figure 13. Reeling Orientation





Note: For detail information on reflow soldering of Avago surface mount LEDs, do refer to Avago Application Note AN 1060 Surface Mounting SMT LED Indicator Components

Packaging Label:

(i) Avago Mother Label (Available on MBB bags)

<p>(1P) Item: Part Number</p> 		<p>AVAGO TECHNOLOGIES STANDARD LABEL LS0002 RoHS Compliant Halogen Free e4 Max Temp 260C MSL2a</p>	
<p>(1T) Lot: Lot Number</p> 		<p>(Q) QTY: Quantity</p> 	
<p>LPN:</p> 		<p>CAT: Intensity Bin</p> 	
<p>(9D)MFG Date: Manufacturing Date</p> 		<p>BIN: Color Bin</p> 	
<p>(P) Customer Item:</p> 			
<p>(V) Vendor ID:</p> 		<p>(9D) Date Code: Date Code</p> 	
<p>DeptID:</p> 		<p>Made In: Country of Origin</p> 	

(ii) Avago Baby Label (Available on reel)

<p>(1P) PART #: Part Number</p> 		<p>AVAGO TECHNOLOGIES BABY LABEL COSB001B V0.0</p>	
<p>(1T) LOT #: Lot Number</p> 		<p>QUANTITY: Packing Quantity</p> 	
<p>(9D)MFG DATE: Manufacturing Date</p> 		<p>(9D): DATE CODE:</p>	
<p>C/O: Country of Origin</p>		<p>D/C: Date Code VF:</p>	
<p>(1T) TAPE DATE:</p> 		<p>CAT: INTENSITY BIN</p>	
		<p>BIN : COLOR BIN</p>	

Example indicates luminous Intensity information for Red, Green and Blue respectively from label:

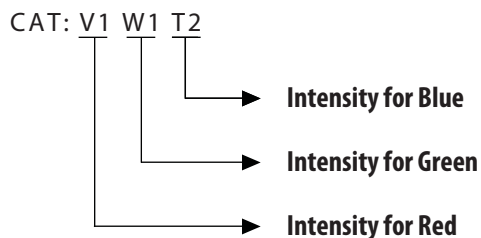

Example indicates color bin information for Green and Blue from label:

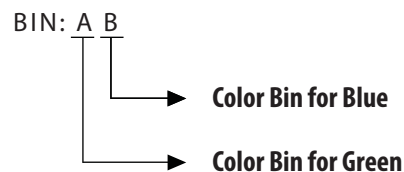

Note: There will be no red color bin information appear on label as it is not binned and support with full distribution range.

Intensity Bin Select (X₂, X₃)

Individual reel will contain parts from 1 half bin only

X ₂	Min Iv Bin (Minimum Intensity Bin)		
	Red	Green	Blue
A	U1	V2	S2

X ₃	Number of Half bin from X ₂		
	Red	Green	Blue
A	4	4	4

Color Bin Select (X₄)

Individual Reel will contain part from 1 full bin only

X ₄	Color Bin Combinations		
	Red	Green	Blue
0	Full distribution	A, B, C	A, B, C, D, E

Packaging Option (X₅)

Option	Test Current	Package Type	Reel Size
2	20 mA	Top mount	7 inch

Intensity Bin Limits

Bin ID	Min (mcd)	Max (mcd)
S2	224.0	285.0
T1	285.0	355.0
T2	355.0	450.0
U1	450.0	560.0
U2	560.0	715.0
V1	715.0	900.0
V2	900.0	1125.0
W1	1125.0	1400.0
W2	1400.0	1800.0
X1	1800.0	2240.0

Tolerance of each bin limit $\pm 12\%$

Color Bin Limits

Red	Min (nm)	Max (nm)
–	618.0	628.0

Green	Min (nm)	Max (nm)
A	525.0	531.0
B	528.0	534.0
C	531.0	537.0

Blue	Min (nm)	Max (nm)
A	465.0	469.0
B	467.0	471.0
C	469.0	473.0
D	471.0	475.0
E	473.0	477.0

Tolerance of each bin limit is ± 1 nm

Handling Precaution

The encapsulation material of the LED is made of silicone for better product reliability. Since silicone is a soft material, avoid pressing on the silicon or poking the silicon with a sharp object as the product could be damaged and cause premature failure. During assembly handling, the unit should be held by the body only. Please refer to Avago Application Note AN 5288 for additional handling information and proper procedures.

Moisture Sensitivity

This product has a Moisture Sensitive Level 2a rating per JEDEC J-STD-020. Refer to Avago Application Note AN5305, Handling of Moisture Sensitive Surface Mount Devices, for additional details and a review of proper handling procedures.

A. Storage before use

- An Unopened moisture barrier bag (MBB) can be stored at < 40°C/90%RH for 12 months. If the actual shelf life has exceeded 12 months and the humidity Indicator Card (HIC) indicates that baking is not required, then it is safe to reflow the LEDs per the original MSL rating.
- It is recommended that the MBB not be opened prior to assembly (e.g. for IQC).

B. Control after opening the MBB

- The humidity indicator card (HIC) shall be read immediately upon opening of MBB.
- The LEDs must be kept at < 30°C/60%RH at all times and all high temperature related processes including soldering, curing or rework need to be completed within 672 hours.

C. Control for unfinished reel

- Unused LEDs must be stored in a sealed MBB with desiccant or desiccator at < 5%RH.

D. Control of assembled boards

- If the PCB soldered with the LEDs is to be subjected to other high temperature processes, the PCB need to be stored in sealed MBB with desiccant or desiccator at <5%RH to ensure that all LEDs have not exceeded their floor life of 672 hours.

E. Baking is required if:

- The HIC indicator is not BROWN at 10% and is AZURE at 5%.
- The LEDs are exposed to condition of > 30°C/60% RH at any time.
- The Led floor life exceeded 672 hrs.

The recommended baking condition is: 60 ±5° C for 20 hrs.

DISCLAIMER: Avago's products and software are not specifically designed, manufactured or authorized for sale as parts, components or assemblies for the planning, construction, maintenance or direct operation of a nuclear facility or for use in medical devices or applications. Customer is solely responsible, and waives all rights to make claims against avago or its suppliers, for all loss, damage, expense or liability in connection with such use.

For product information and a complete list of distributors, please go to our web site: www.avagotech.com

Avago, Avago Technologies, and the A logo are trademarks of Avago Technologies in the United States and other countries. Data subject to change. Copyright © 2005-2011 Avago Technologies. All rights reserved. AV02-3200EN - October 10, 2011

AVAGO
TECHNOLOGIES

X-ON Electronics

Largest Supplier of Electrical and Electronic Components

Click to view similar products for [avago manufacturer](#):

Other Similar products are found below :

[ACPL-C790-500E](#) [PEX8724-CA RDK](#) [HCMS-2962](#) [HCPL-0611-000E](#) [HEDM-5500#B02](#) [HEDS-8937](#) [HEDS-9731#A50](#) [HFBR-5961ALZ](#)
[HEDS-5505-A06](#) [HCPL-2631-000E](#) [ACPL-K64L-060E](#) [AFBR-5803AZ](#) [PEX8747-CA RDK](#) [HCPL-5431](#) [409091B](#) [5962-8957201XA](#)
[610861X](#) [610962A](#) [6N140A/883B](#) [8302401EC](#) [HCPL-0731-500E](#) [HEDS-8949](#) [HLMP-2550](#) [ACPL-K342-060E](#) [4N46](#) [HCNW4503-000E](#)
[HFBR-1415TZ](#) [HCPL-0600-500E](#) [HCPL-0930-000E](#) [HEDL-5540-I06](#) [HCPL-5401](#) [HLMP-1301-E00A1](#) [HCPL-4503-520E](#) [HEDS-5540#I06](#)
[HFBR-2316TZ](#) [HEDS-6140#B09](#) [HCMS-3906](#) [HEDS-9700H52](#) [HFBR-1515BZ](#) [ACPL-5631L](#) [HLMA-QL00](#) [HSSR-7112](#) [HDLS-1414](#)
[HFBR-RSD005Z](#) [HLMP-1540](#) [055407X](#) [5962-8876801PA](#) [HCMS-2922](#) [HCPL-2232-300](#) [HEDS-5500#I12](#)