

Technical Specification:

DC Sounder with LED beacon

Supply Voltage Range	17-60V DC
Current – Sounder & beacon	10-50mA*
Current – Beacon only	5mA
Peak Sound Level:	96-107 dBA at 1m*
Number of Tones:	32 – dipswitch selectable
Frequency Range	400-2850 Hz*
Operating Temperature:	- 25°C to +70°C
Casing:	High Impact Polycarbonate
IP Rating:	IP65 (with deep base)
Synchronisation	Automatic with other Klaxon 32 Tone Sounders
Volume Adjustment	20dB
Beacon Control	Optional independent control of beacon with separate negative supply
Locking mechanism	Optional by removing tab on base
Compliance	EN54-3:2001
Body colour	Red or white
Beacon lens colours	Red or amber











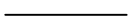
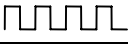
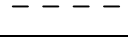
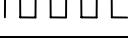
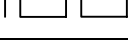
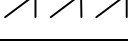
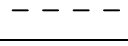
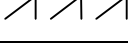
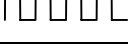
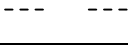

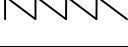
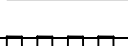
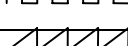
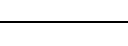
*depends on selected tone and input voltage

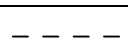
Part Numbers:

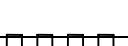
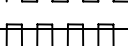
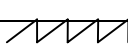
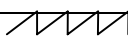
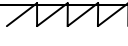
Sounder Beacon DC/Timesaver	Red lens/red base	Head only	18-980502
		Shallow base	18-980500
		Deep base	18-980501
	Amber lens/red base	Head only	18-980505
		Shallow base	18-980503
		Deep base	18-980504
Beacon only DC/Timesaver	Red lens/red base	Head only	18-980509
		Shallow base	18-980507
		Deep base	18-980508
	Amber lens/red base	Head only	18-980512
		Shallow base	18-980510
		Deep base	18-980511

Sonos

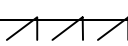
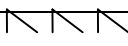
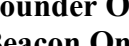
Tone Table

TONE	TONE TYPE	TONE DESCRIPTION/ APPLICATION	2 ND STAGE TONE	DIP SWITCH 1_2_3_4_5	SOUND LEVEL (dBA @ 1m)	AVERAGE CURRENT (mA)
1		970Hz (BS5839-1:2002)	4	0-0-0-0-0	97	22
2		800Hz/970Hz @ 2Hz (BS5839-1:2002)	1	0-0-0-0-I	97	21
3		800Hz – 970Hz @ 1Hz (BS5839-1:2002)	1	0-0-0-I-0	98	21
4		970Hz 1s OFF/1s ON (Apollo Fire Systems Alert Tone, BS5839-1:2002)	1	0-0-0-I-I	96	15
5		970Hz, 0.5s/ 630Hz, 0.5s (Apollo Fire Systems Alert Tone, BS5839-1:2002)	4	0-0-I-0-0	97	20
6		554Hz, 0.1s/ 440Hz, 0.4s (France - AFNOR NF S 32 001)	1	0-0-I-0-I	96	14
7		500 - 1200Hz, 3.5s/ 0.5s OFF (Netherlands – NEN 2575:2000)	1	0-0-I-I-0	99	17
8		420Hz 0.625s ON/0.625s OFF (Australia AS2220 Alert tone)	9	0-0-I-I-I	93	12
9		500 - 1200Hz, 3.75s/ 0.25s OFF (Australia AS2220 Evacuation tone)	8	0-I-0-0-0	99	17
10		550Hz/440Hz @ 0.5Hz	1	0-I-0-0-I	99	11
11		970Hz, 0.5s ON/0.5s OFF x 3/ 1.5s OFF (ISO 8201 Low tone)	12	0-I-0-I-0	97	13
12		2850Hz, 0.5s ON/0.5s OFF x 3/1.5s OFF (ISO 8201 High tone)	11	0-I-0-I-I	93	24
13		1200Hz – 500Hz @ 1Hz (DIN 33 404)	1	0-I-I-0-0	97	18
14		400Hz	6	0-I-I-0-I	92	14
15		550Hz, 0.7s/1000Hz, 0.33s ('SafeSound')	1	0-I-I-I-0	99	18
16		1500Hz - 2700Hz @ 3Hz (Vandal Alarm)	1	0-I-I-I-I	105	36
17		750Hz	27	I-0-0-0-0	98	19
18		2400Hz	26	I-0-0-0-I	106	39
19		750Hz 0.33s ON/0.51s OFF	1	I-0-0-I-0	98	12
20		750Hz 0.51s ON/0.33s OFF	1	I-0-0-I-I	98	14
21		800Hz 0.2s ON/0.2s OFF	1	I-0-I-0-0	97	13
22		510Hz, 0.5s/ 610Hz, 0.5s	4	I-0-I-0-I	95	16
23		550Hz, 0.33s/1000Hz, 0.7s	1	I-0-I-I-0	99	21
24		250Hz – 1200Hz @ 12Hz	18	I-0-I-I-I	94	14
25		500Hz – 1200Hz @ 0.33Hz.	18	I-I-0-0-0	99	18
26		2500Hz – 2850Hz @ 7Hz.	18	I-I-0-0-I	98	49
27		600Hz – 900Hz/ 0.9s	1	I-I-0-I-0	97	19
28		660Hz – 680Hz/ 0.9s	1	I-I-0-I-I	95	15
29		670Hz – 725Hz/ 0.9s	1	I-I-I-0-0	96	19
30		920Hz – 750Hz/ 0.9s	1	I-I-I-0-I	98	20
31		700Hz – 900Hz, 0.3s/0.6s OFF	1	I-I-I-I-0	97	10
32		900Hz – 760Hz, 0.6s/0.3s OFF	1	I-I-I-I-I	98	15

Sounder Only: Subtract 4mA from figure in table
Beacon Only: 5mA

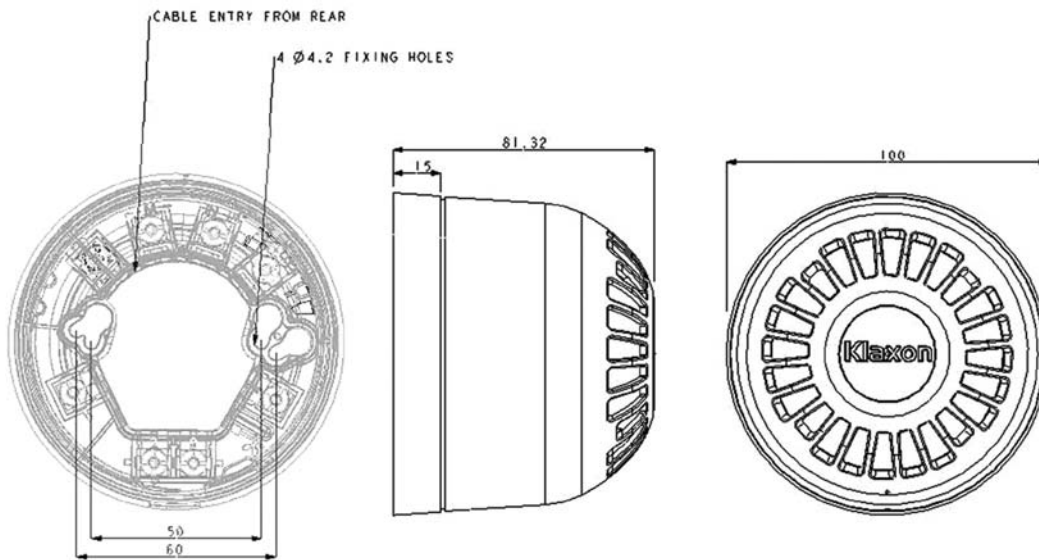
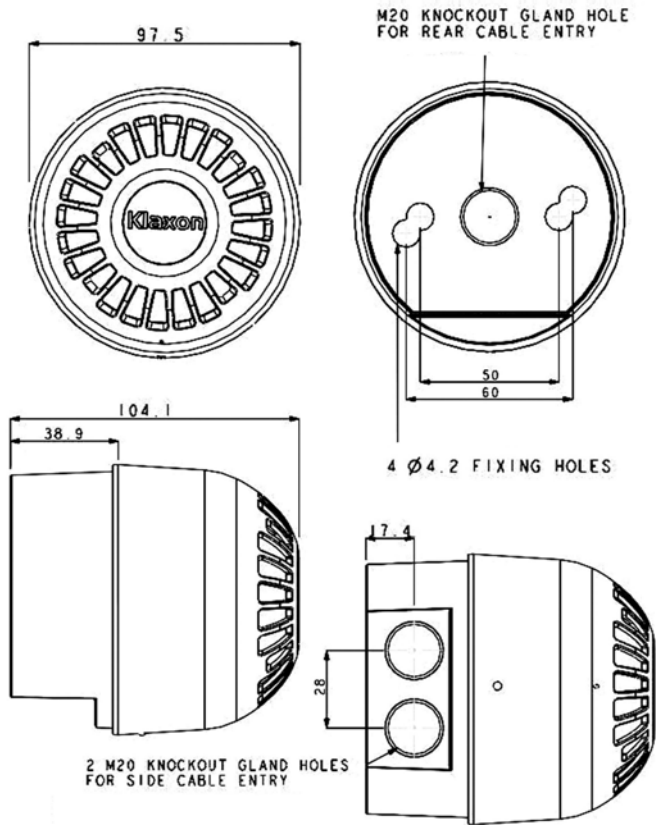

X-ON Electronics

Largest Supplier of Electrical and Electronic Components

Click to view similar products for [klaxon](#) manufacturer:

Other Similar products are found below :

[PNS-0011](#) [PNV-0006](#) [SLD-0002](#) [PSS-0063](#) [PNV-0018](#) [PNC-0013](#) [PNV-0001](#) [18-980228](#) [SLE-0004](#) [QBS-0023](#) [18-980205](#) [QBS-0038](#)
[PSB-0004](#) [QBS-0065](#) [18-980476](#) [QBS-0042](#) [QBS-0026](#) [QBS-0052](#) [QBS-0056](#) [PNC-0009](#) [PNS-0009](#) [PNC-0007](#) [QBS-0063](#) [PSS-0096](#)
[QBS-0022](#) [QBS-0002](#) [PSS-0094](#) [PSB-0017](#) [18-980451](#) [PSB-0026](#) [PSB-0040](#) [QBS-0067](#) [PNC-0002](#) [PSB-0002](#) [QBS-0058](#) [QBS-0017](#) [SLA-0002](#) [PSB-0039](#) [QBS-0047](#) [PSB-0009](#) [PSB-0031](#) [QBS-0018](#) [QBS-0020](#) [QBS-0054](#)