

3 Port Solenoid Valve Rubber Seal Series SY100

**Low power consumption: 0.5W (Standard, Without light)
(Current draw: 21mA at 24V DC)**

*Large flow capacity style: 0.75W (Current draw: 31mA at 24V DC)

Body width: 10mm
7.85 N ℓ /min (Standard style)
11.78 N ℓ /min (Large flow capacity style)

Exceedingly long life
100 million cycles (By SMC life test data)

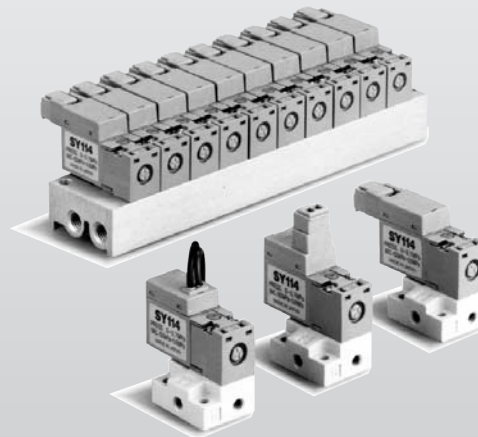
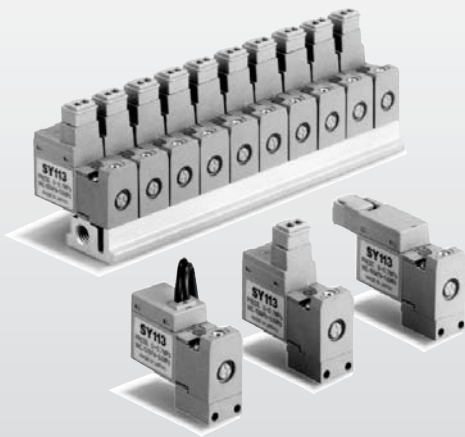

Vacuum Applications Possible

Can be used up to -100kPa

Copper free

No copper used for sections in contact with fluids.

Bright colour tone and "state of the art" design

A bright grey concept has been adopted for this product to complement the surrounding operational environment.

SY100/ Application example (Pneumatic symbols shown are typical examples.)

- ① Valve for blow off ② Valve for vacuum ③ Operation for single acting cylinder ④ Operation for air operated style fluid control valve

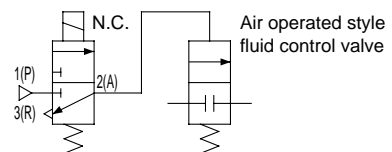
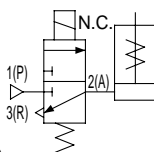
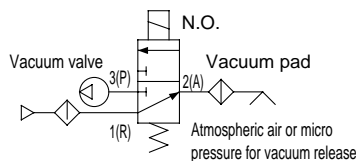
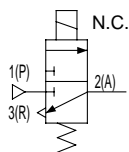

Characteristics values indicated in this catalog are not guaranteed values but typical ones.

SY

SYJ

VK

VZ

VT

VT

VP

VG

VQ

VQZ

⚠️ Precautions

Be sure to read before handling. Refer to p.0-33 to 0-36 for Safety Instructions and common precautions.

⚠️ Warning

Operation of Manual Override

Make sure that there is no danger, since manual override operation can make any connected equipment operate.

■ **Non-locking push style [Standard style]** ■ **Locking slotted style [B]**

Press in the direction of the arrow. Turn in the direction of arrow.

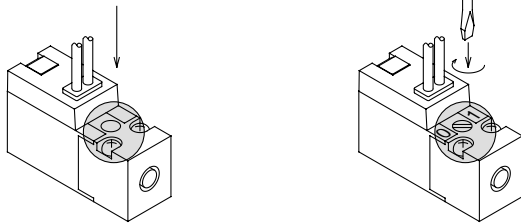

■ **Push-locking slotted style [D]** ■ **Push-locking lever style [E]**

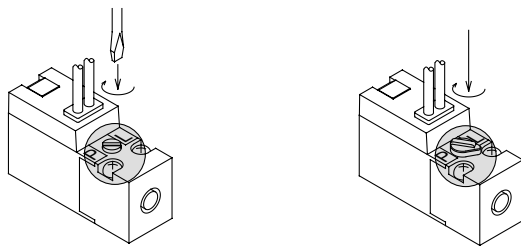

(Pressing makes the valve operate. The valve can be locked in the manual override position by turning it to the direction that the arrow shows while keeping it pressed. If it is not turned, it can be used as a non-locking push style.)

⚠️ Caution

Gently operate locking manual override styles B, D using small screwdriver. [Torque: 0.1Nm or less]

⚠️ Caution

How to Use Plug Connector

① Connection/Disconnection of connector

● **Connection:** Push the connector straight onto the pins of the solenoid, making sure the lip of the lever securely “locks” into the groove of the solenoid cover.

● **Disconnect:** Press the lever against the connector housing and pull it outward from the solenoid.

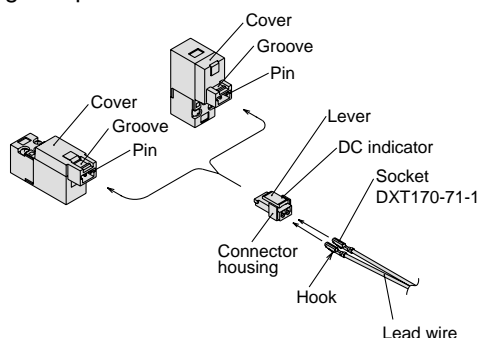

② Crimping connection of lead wire and socket

Strip 3.2 to 3.7mm of the lead wire ends, insert each stripped wire into a socket and crimp contact it using special crimping tool. Be careful that the outer insulation of the lead wires does not interfere with the socket contact part. Use exclusive crimping tool for crimping. (Contact SMC for special crimping tool.)

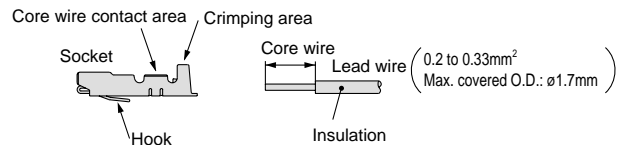

③ Connection/Disconnection of socket with lead wire

● Connection

Insert lead wire and crimped socket into square holes (indicated as A, B, COM) of connector. Press the socket in fully until the hook of the socket locks into the groove of the connector housing. Confirm the locked position by lightly pulling on the lead wire.

● Disconnection

To remove the socket from the connector, pull out lead wire while depressing the hook of the socket with a fine screw driver (≅1mm). If the socket is to be re-used, reposition the hook again.

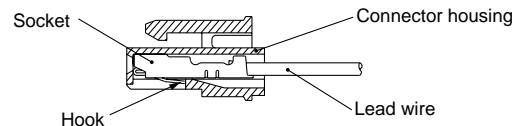

Plug Connector Lead Wire Length

Standard length is 300mm, but the following lengths are also available.

How to Order Connector Assembly

For DC: **SY100-30-4A** - []

Without lead wire: **SY100-30-A**

(Only with a connector and two sockets.)

How to Order

To order a valve with lead wire length of other than 300mm, indicate part numbers of the valve without connector and the required connector ass'y separately. Example: 2000mm lead wire length

For DC
SY114-5LO
SY100-30-4A-20

● Lead wire length

—	300mm
6	600mm
10	1000mm
15	1500mm
20	2000mm
25	2500mm
30	3000mm
50	5000mm

Surge Voltage Suppressor

<DC>

Grommet, L and M plug connector

Standard style (With polarity) With surge voltage suppressor

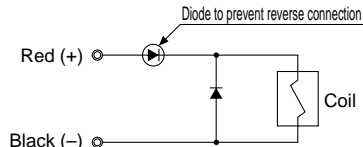

Indicator light and surge voltage suppressor (□Z)

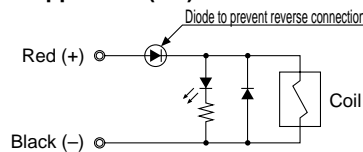

Non-polar style With surge voltage suppressor ("□R")

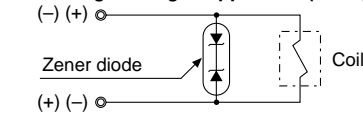

Indicator light and surge voltage suppressor ("□U")

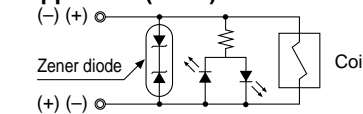

- Please connect correctly the lead wires to ⊕ (positive) and ⊖ (negative) indications on the connector.
For non-polar style, the lead wires can be connected to either one.
- For DC voltages other than 12, 24V DC, incorrect wiring will cause damage to the surge voltage suppressor circuit. (Wrong polarity will cause trouble.)
- Solenoids, whose lead wires have been pre-wired: positive side red and negative side black.

⚠ Caution

Since there is some residual voltage according to the protection device and rated voltage in case of voltage surge suppressor by zener diode, pay attention to the surge protection on the controller side. (Diode residual voltage: $\approx 1V$)

Connector Assembly with Protective Cover

Connector assembly with protective cover enhances dust protection.

- Effective in preventing possible short circuit problems due to contaminants in contact with connector section.
- Cover material is chloroprene rubber which has excellent weatherability and electric insulation properties. However, be careful not to allow contact with cutting oil.
- Round cord provides neat appearance.

How to Order

SY100-68-A



Lead wire (L)

—	300mm
6	600mm
10	1000mm
15	1500mm
20	2000mm
25	2500mm
30	3000mm
50	5000mm

Connector Assembly with Cover/Dimension

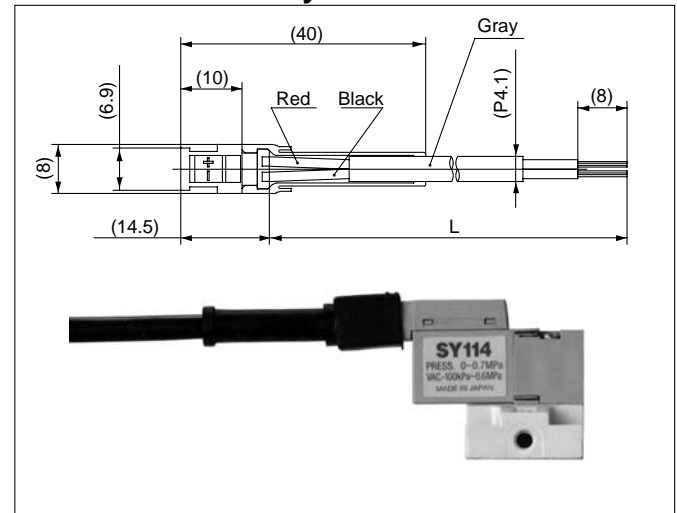

How to Order

Indicate part number of connector assembly with cover in addition to the solenoid valve part number without connector of the plug connector.

<Example 1> Lead wire length: 2000mm

SY114-5LOZ-M3-Q

SY100-68-A-20

<Example 2> Lead wire length: 300mm (Standard)

SY114-5LPZ-M3-Q

Symbol of connector assembly with cover

*No part numbers of connector assembly with cover are needed to be indicated in this case.

SY

SYJ

VK

VZ

VT

VT

VP

VG

VQ

VQZ

3 Port Direct Operated Rubber Seal Series SY100

Model



Body ported



Base mounted

Actuation	Model	Style	Operating pressure range (MPa)	Vacuum application (MPa)		Effective area (mm ²) (N _e /min)	Weight (g) ⁽²⁾	
				P port	R port		Grommet style	L, M Plug connector
N.C.	SY11 ³ ₄	Standard	0 to 0.7	-100kPa to 0.6	-100kPa to 0	0.14 (7.85)		
N.C.	SY11 ³ ₄ A	Large flow capacity	0 to 0.7	-100kPa to 0.6	-100kPa to 0	0.22 (11.78)	SY1□3 (A): 13 SY1□4 (A): 24	SY1□3 (A): 15 SY1□4 (A): 26
N.O.	SY12 ³ ₄ ⁽¹⁾	Standard	0 to 0.7	-100kPa to 0	-100kPa to 0.6	0.14 (7.85)	(Without sub-plate 12)	(Without sub-plate 14)
N.O.	SY12 ³ ₄ A ⁽¹⁾	Large flow capacity	0 to 0.7	-100kPa to 0	-100kPa to 0.6	0.22 (11.78)		



Note 1) SY123/SY124 and SY123/SY124 A: Supply pressure to 1(R) port and exhaust air from 3(P) port.
Note 2) Value for DC.

Specifications

Fluid	Air
Ambient and fluid temperature (°C)	Max. 50°C
Response time (ms) ⁽¹⁾	10ms or less
Max. operating frequency (Hz)	20
Manual override	Non-locking push, Locking slotted, Push-locking slotted, Push-locking lever
Lubrication	Not required
Mounting position	Free
Impact/Vibration resistance (m/s ²) ⁽²⁾	150/30
Enclosure	Dust-proof



Note 1) According to dynamic performance test JIS B8374-1981 (Coil temperature 20°C, at rated voltage, without surge suppressor.)

Note 2) Impact resistance: No malfunction from tests using drop impact tester, to axis and right angle direction of main valve and armature, each one time when energized and de-energized. (Value in the initial stage)

Vibration resistance: No malfunction from tests with 8.3~2000Hz 1 sweep, to axis and right angle direction of main valve and armature, each one time when energized and de-energized. (Value in the initial stage.)

JIS Symbol

SY11³₄(A)

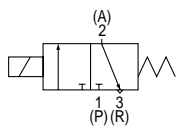

SY12³₄(A)

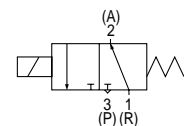

P.2.1-15

Solenoid Specifications

Series		SY1 ¹³ ₂₄	SY1 ¹³ ₂₄ A
Electrical entry		Grommet (G), (H), L plug connector (L), M plug connector (M)	
Coil rated voltage (V)	DC	24, 12, 6, 5, 3	
Allowable voltage		-10 to +10%	
Power consumption (W) ⁽¹⁾	DC	0.5W (With light: 0.55W)	0.75W (With light: 0.8W)
Surge voltage suppressor		Diode	
Indicator light		LED	

(1) At rated voltage

How to Order

Standard (7.85 Nl/min)

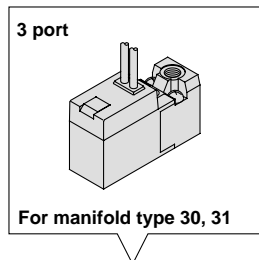

Standard (Nl/min: 7.85) : Body ported

SY1 1 3 - 5 L [] [] [] M3 - Q

Standard (Nl/min: 7.85) : Base mounted

SY1 1 4 - 5 M [] [] [] - Q

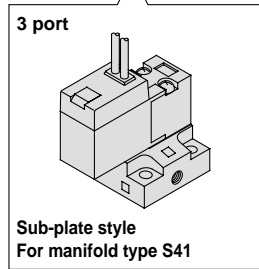

Actuation

1	Normally closed
2	Normally open

Rated voltage

5	24V DC
6	12V DC
V	6V DC
S	5V DC
R	3V DC
9	50V or less

Contact SMC for other voltages (9)

Light and surge voltage suppressor

—	Without light and surge voltage suppressor
S	With surge voltage suppressor
Z	With light and surge voltage suppressor
U	With light and surge voltage suppressor (Non-polar style)

Piping

— : For manifold P : For body ported style to P, R, A port

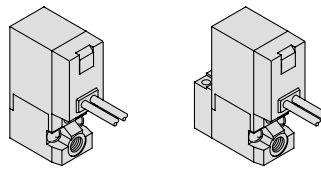

Bracket

— : Without bracket F : With bracket

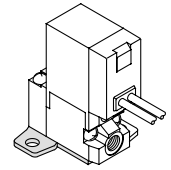

"P" piping specification only.

Piping port

— : Without sub-plate M3: With sub-plate

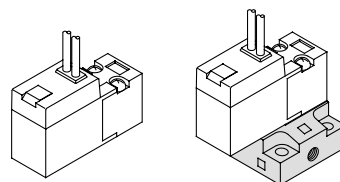

(With gasket and screw)

Electrical entry

24V, 12V, 6V, 5V, 3V DC			
Grommet	L plug connector	M plug connector	
G: 300mm lead wire	L: 300mm lead wire	M: 300mm lead wire	MN: Without lead wire
H: 600mm lead wire	LN: Without lead wire	LO: Without connector	MO: Without connector

*LN or MN option includes 2 sockets.



Protective class class III (Mark:)

Manual override

— : Non-locking push style D: Push-locking slotted style

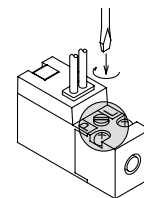
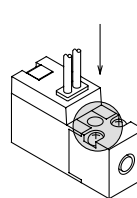

B: Locking slotted style

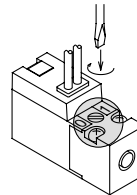

E: Push-locking lever style

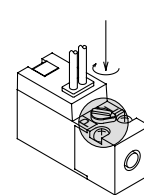

SY114/SY124, SY114A/SY124A only.

SY

SYJ

VK

VZ

VT

VT

VP

VG

VQ

VQZ

Series SY100

How to Order

Large flow capacity (11.78 Nl/min)

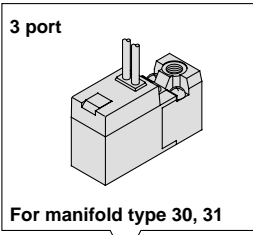

Large flow capacity : Body ported
(11.78 Nl/min)

Large flow capacity : Base mounted
(11.78 Nl/min)

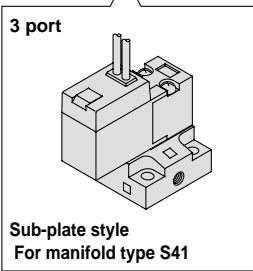

Light and surge voltage suppressor

—	Without light and surge voltage suppressor
S	With surge voltage suppressor
Z	With light and surge voltage suppressor
U	With light and surge voltage suppressor (Non-polar style)

Piping

—: For manifold P: For body ported style to P, R, A port

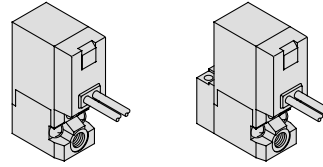

Bracket

—: Without bracket F: With bracket

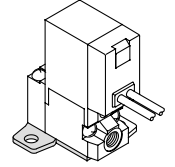

"P" piping specification only.

Actuation

1	Normally closed
2	Normally open

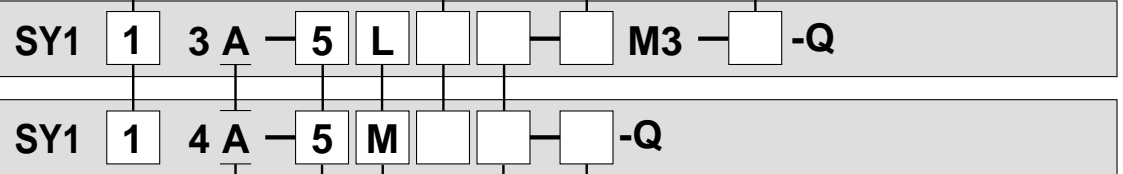

Rated voltage

5	24V DC
6	12V DC
V	6V DC
S	5V DC
R	3V DC
9	50V or less

Order Made Contact SMC for other voltages (9)

Piping port

—: Without sub-plate M3: With sub-plate

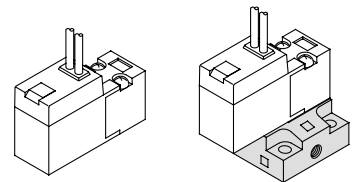

(With gasket and screw)

Large flow capacity

Electrical entry

24V, 12V, 6V, 5V, 3V DC			
Grommet	L plug connector	M plug connector	
G: 300mm lead wire	L: 300mm lead wire	M: 300mm lead wire	MN: Without lead wire
H: 600mm lead wire	LN: Without lead wire	LO: Without connector	MO: Without connector

*LN or MN option includes 2 sockets.

Manual override

—: Non-locking push style D: Push-locking slotted style

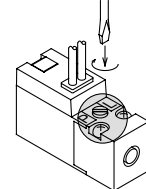
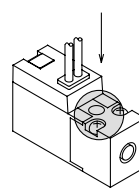

B: Locking slotted style

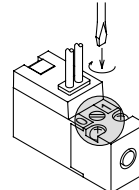

E: Push-locking lever style

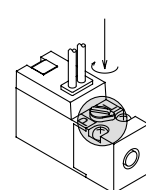

SY114/SY124, SY114A/SY124A only.

Protective class class III (Mark: ⚡)

Construction

SY114, SY114A

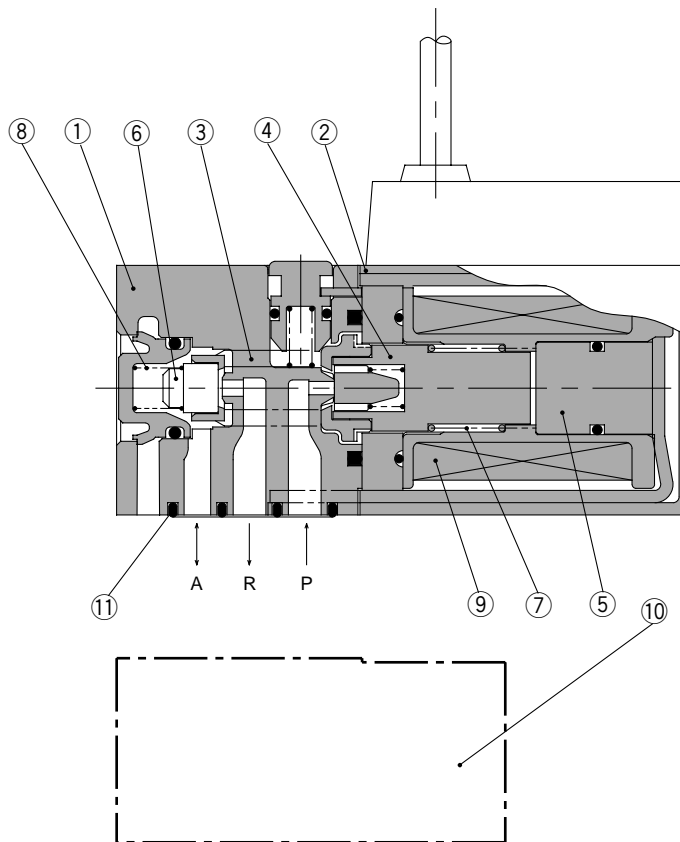
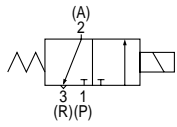

SY

SYJ

VK

VZ

VT

VT

VP

VG

VQ

VQZ

Component Parts

No.	Description	Material	Notes
①	Body	Resin	Gray
②	Cover	Resin	Gray
③	Push rod	Resin	—
④	Armature ass'y	NBR/Stainless steel	—
⑤	Core	Stainless steel	—
⑥	Exhaust poppet	NBR	—
⑦	Return spring	Stainless steel	—
⑧	Poppet spring	Stainless steel	—
⑨	Coil ass'y	—	—

Replacement Parts

No.	Description	Part No.	Material
⑩	Sub-plate	SY100-74-1-Q	Zinc die cast
⑪	Gasket	VJ100-6-1-Q	NBR

How to Order Connector Assembly

For DC: **SY100-30-4A** 

Without lead wire: **SY100-30-A**
(Only with a connector and two sockets.)

Lead wire

—	300mm
6	600mm
10	1000mm
15	1500mm
20	2000mm
25	2500mm
30	3000mm
50	5000mm

Series SY100

Body Ported

Grommet (G), (H): SY1₂¹/₃ (A)-□^G□□-PM3 (-F) -Q

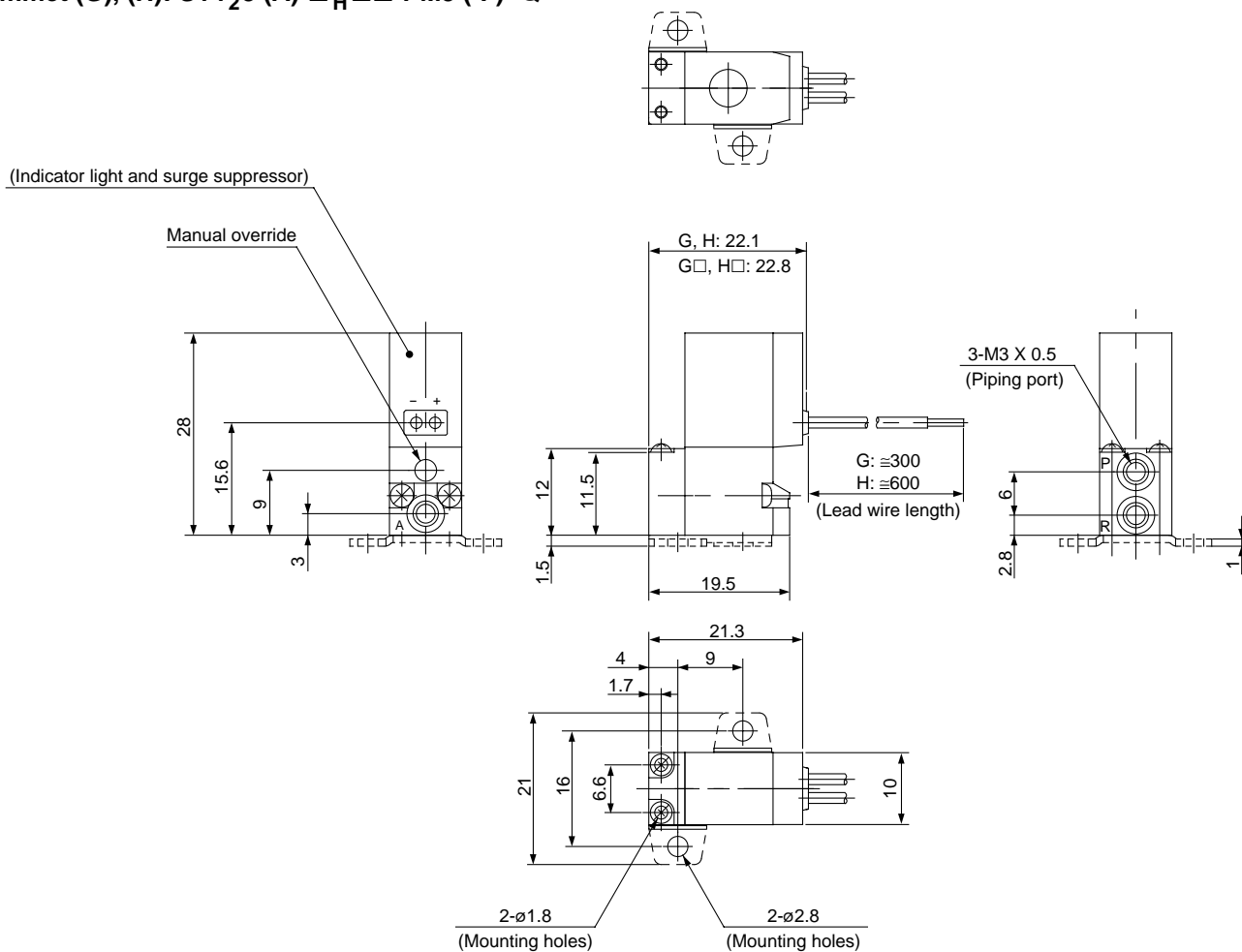

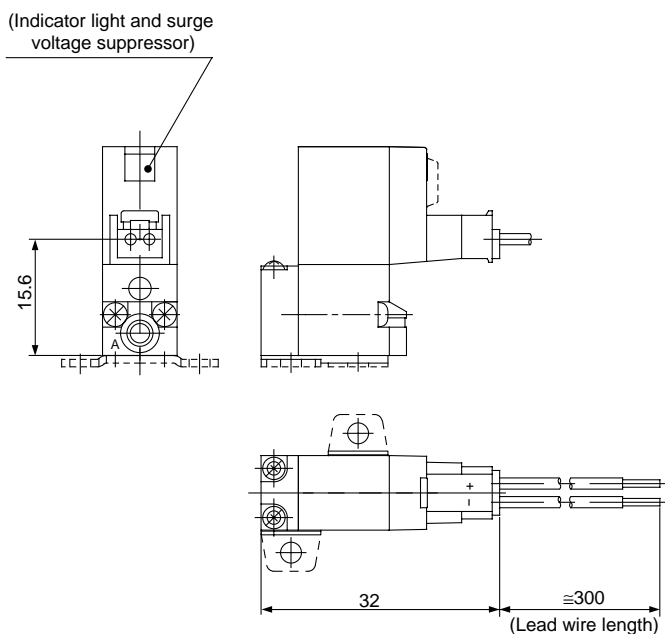

L plug connector (L): SY1₂¹/₃ (A)-□L□□-PM3 (F)-Q

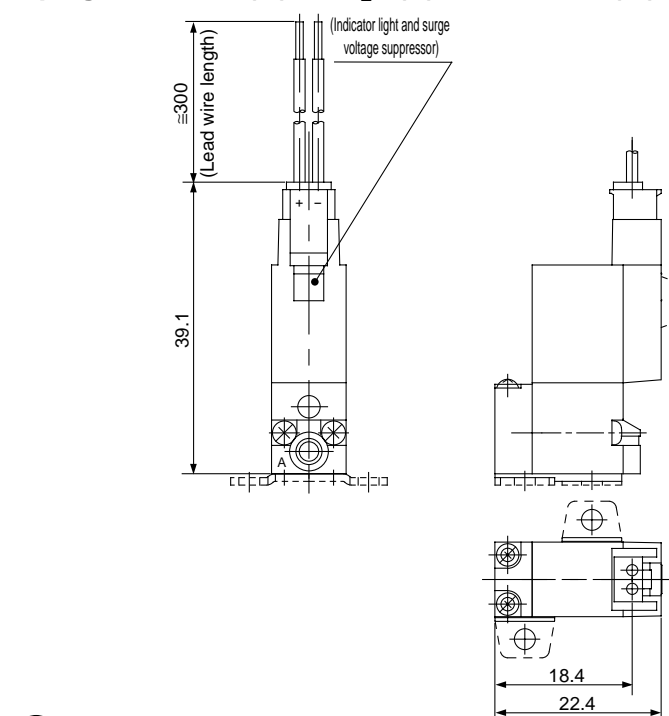

M plug connector (M): SY1₂¹/₃ (A)-□M□□-PM3 (-F)-Q



 * Other dimensions are same as grommet style.

 * Other dimensions are same as grommet style.

Base Mounted (With Sub-plate)

Grommet (G), (H): SY1₂₄ (A)-□^G_H□□-M3-Q

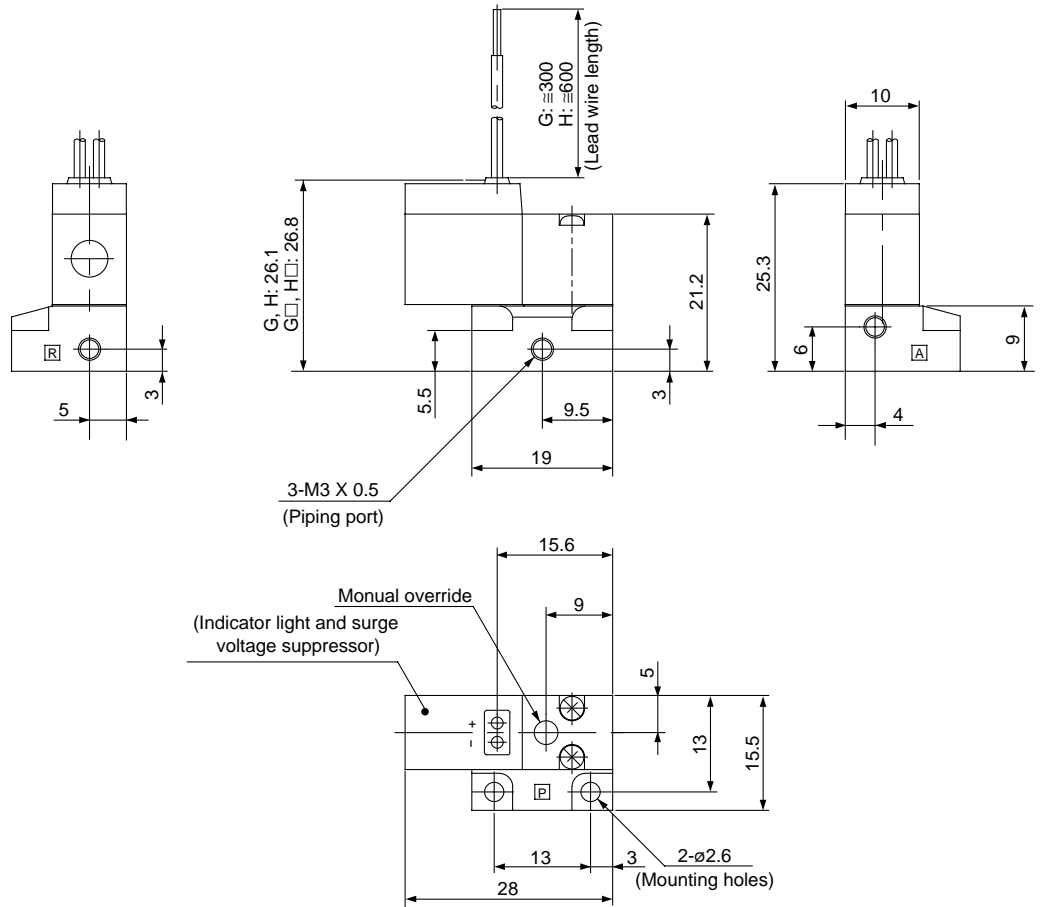

SY

SYJ

VK

VZ

VT

VT

VP

VG

VQ

VQZ

L plug connector (L): SY1₂₄ (A)-□L□□-M3-Q

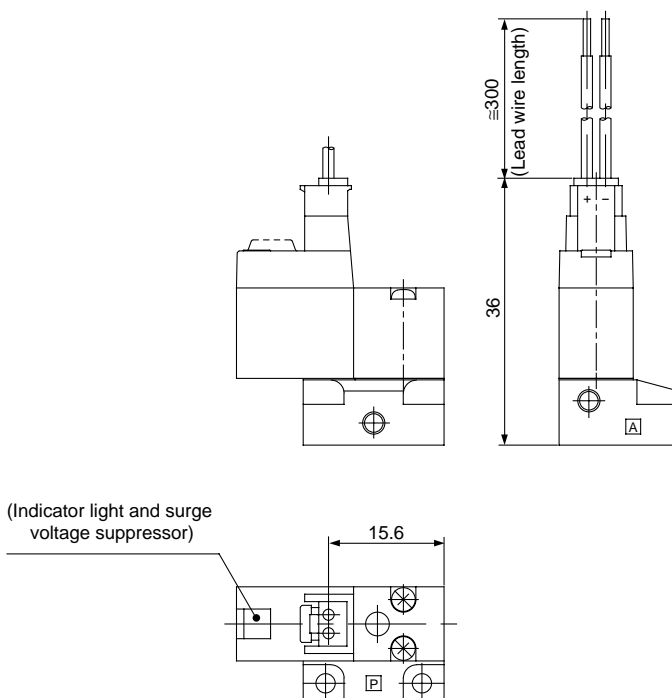

(Indicator light and surge voltage suppressor)



* Other dimensions are same as grommet style.

M plug connector (M): SY1₂₄ (A)-□M□□-M3-Q

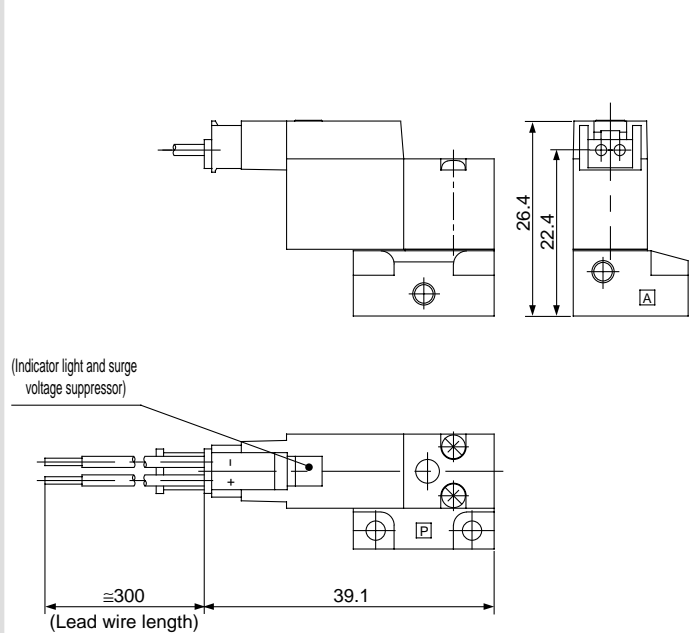

(Indicator light and surge voltage suppressor)



* Other dimensions are same as grommet style.

Series SY100 Manifold

Specifications

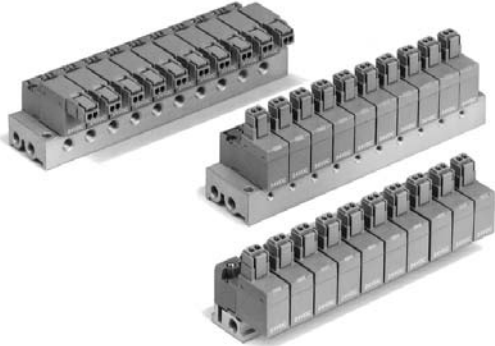

Type	30 ⁽⁴⁾	31	S41
Manifold style	Single base style, B mount		
P (SUP)/R (EXH) style	Common SUP/Common EXH		
Valve stations	2 to 10 stations	2 to 20 stations	
A porting	Location	Valve	Base
	Direction	Top	Side
Port size	P, R port	M5 X 0.8	
	A port	M3 X 0.5	M3 X 0.5, M5 X 0.8
Valve effective area mm ² (Nl/min) ⁽¹⁾	SY1□3	0.14 (7.85)	—
	SY1□3A	0.21 (11.78)	—
	SY1□4	—	0.13 (6.87)
	SY1□4A	—	0.2 (10.8)



Note 1) When mounted on manifold base

Note 2) SY114 (A) and SY124 (A) can not be mounted on the same manifold.

Note 3) Supply to R port and exhaust from P port for SY124 (A).

Note 4) 30 Type is applicable only for SY113 and SY113A. Piping to exhaust port is not possible.

How to Order Manifold Base (Ordering Example)

Example

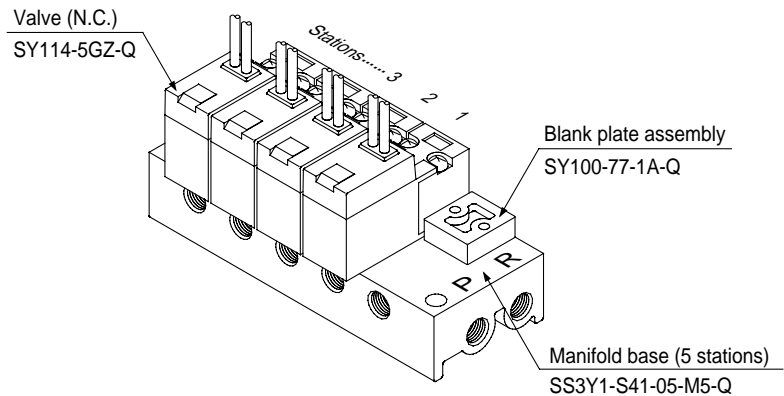

SS3Y1-S41-05-M5-Q.....1set (S41 type 5-station manifold part number)

SY100-77-1A-Q.....1set (Blank plate assembly part number)

SY114-5GZ-Q.....4set (Valve)

List part numbers of the installed valve and option in required station location separately under manifold part number.



Protective class
class III (Mark: ⚡)

Common SUP/Common EXH

30 Type

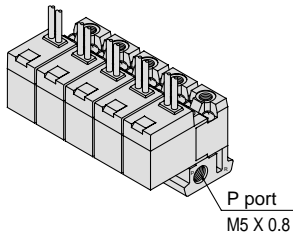

How to Order

SS3Y1 - 30 - 05 - F-Q

● Stations

02	2 stations
⋮	⋮
10	10 stations

Applicable solenoid valve ⁽¹⁾

SY113-□□□□-M3-Q

SY113A-□□□□-M3-Q

Applicable blank plate assembly

SY100-77-1A-Q



Note 1) Piping to exhaust port not possible.

31 Type

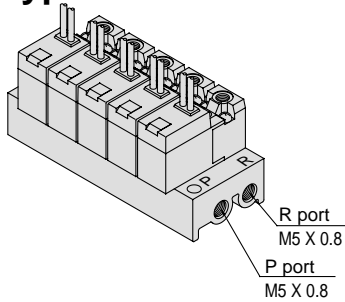

How to Order

SS3Y1 - 31 - 05 - Q

● Stations

02	2 stations
⋮	⋮
20	20 stations

Applicable solenoid valve ⁽¹⁾

SY113-□□□□-M3-Q

SY113A-□□□□-M3-Q

SY123-□□□□-M3-Q

SY123A-□□□□-M3-Q

Applicable blank plate assembly

SY100-77-1A-Q



Note 1) SY113 (A) and SY123 (A) cannot be mounted on the same manifold.

S41 Type

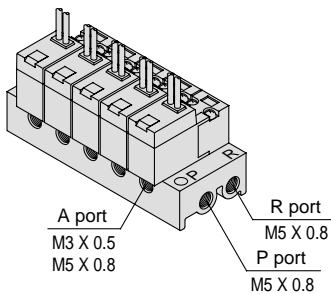

How to Order

SS3Y1 - S41 - 05 - M3 - Q

● Stations

02	2 stations
⋮	⋮
20	20 stations

● A port size

M3	M3 X 0.5
M5	M5 X 0.8

Applicable solenoid valve ⁽¹⁾

SY114-□□□□-Q

SY114A-□□□□-Q

SY124-□□□□-Q

SY124A-□□□□-Q

Applicable blank plate assembly

SY100-77-1A-Q



Note 1) SY114 (A) and SY124 (A) cannot be mounted on the same manifold.



Protective class class III (Mark: ⚡)

Combination with Solenoid Valve and Gasket Manifold Base

Body ported

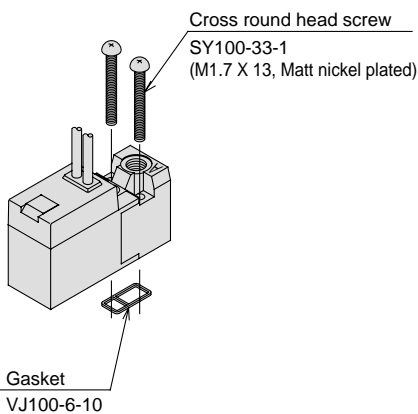

Applicable base

Sub-plate (For body ported style)
SS3Y1-30 type } Manifold base
SS3Y1-31 type }

Base mounted

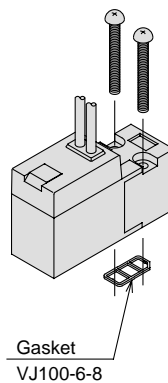

Applicable base

Sub-plate
SS3Y1-S41 type manifold base

Blank Plate Assembly

Parts No.: SY100-77-1A-Q

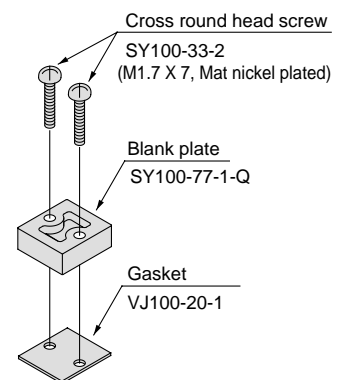

Applicable base

Sub-plate
SS3Y1- 30 type } Manifold base
SS3Y1- 31 type }
SS3Y1- S41 type }

Series SY100

30 Type Manifold: Top Ported/SS3Y1-30-Station -F-Q

Grommet (G), (H)

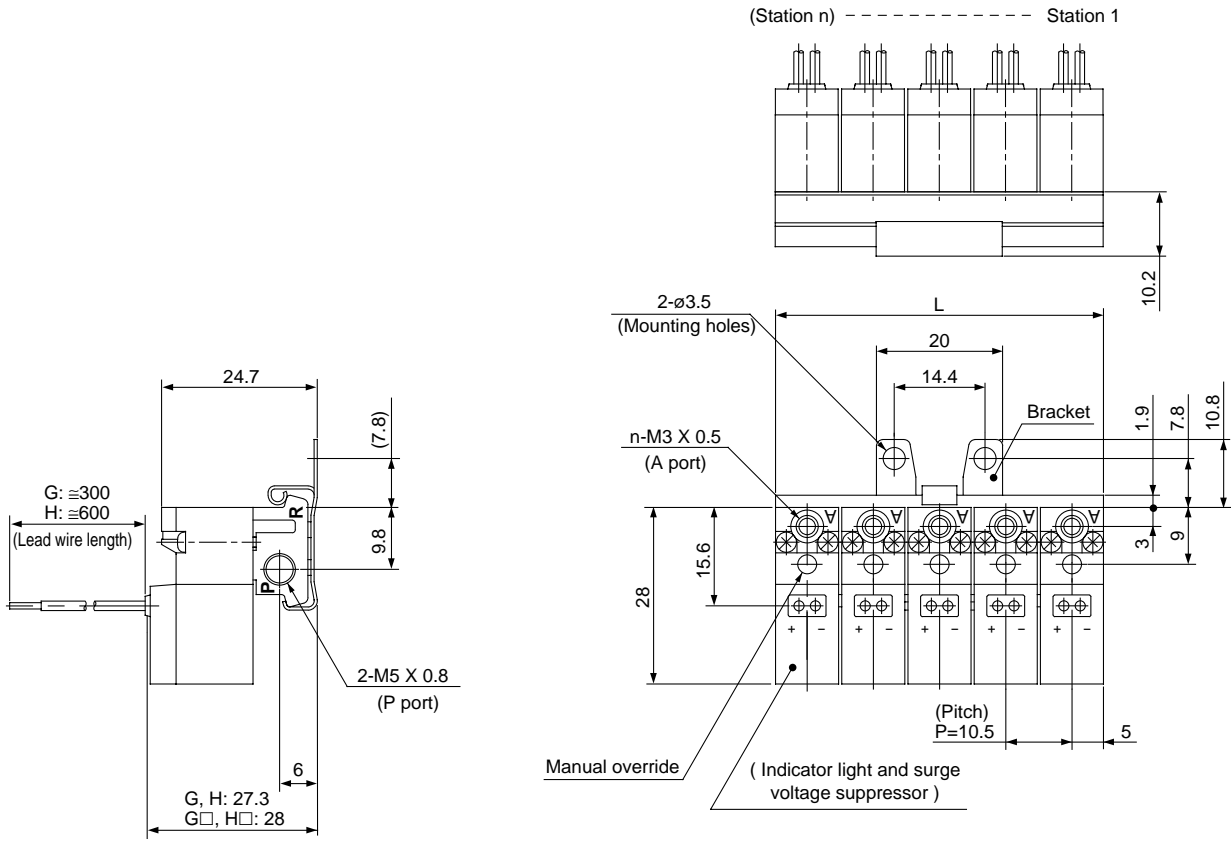

 * No bracket is assembled prior to delivery. Mount one to the appropriate position. (Attach two brackets if more than five stations.)

L plug connector (L)

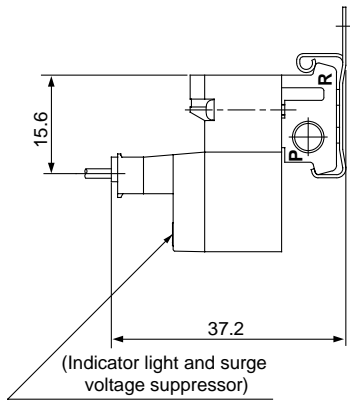

 * Other dimensions are same as grommet style.

M plug connector (M)

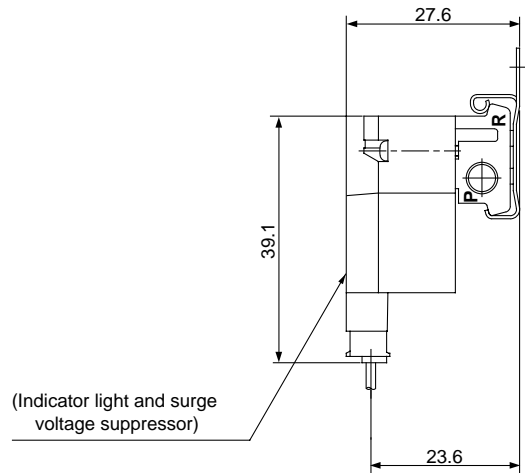

 * Other dimensions are same as grommet style.

Station	2	3	4	5	6	7	8	9	10
L	20.5	31	41.5	52	62.5	73	83.5	94	104.5

31 Type Manifold: Top Ported/SS3Y1-31-Station-Q

Grommet (G), (H)

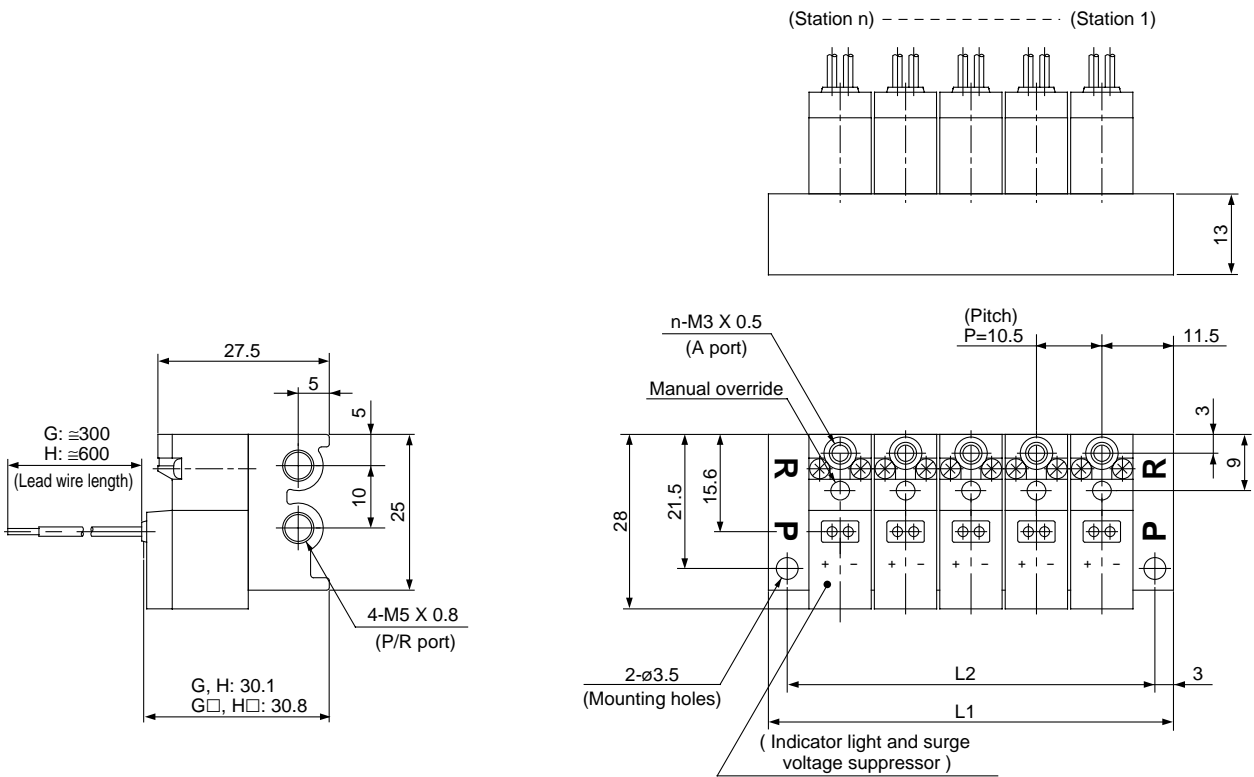

- SY
- SYJ
- VK
- VZ
- VT
- VT
- VP
- VG
- VQ
- VQZ

L plug connector (L)

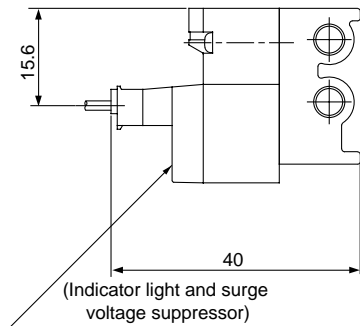

* Other dimensions are same as grommet style.

M plug connector (M)

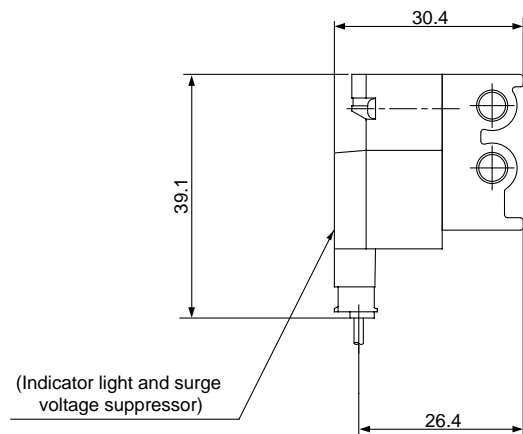

* Other dimensions are same as grommet style.

Station	2	3	4	5	6	7	8	9	10	11	12	13	14	15	16	17	18	19	20
L ₁	33.5	44	54.5	65	75.5	86	96.5	107	117.5	128	138.5	149	159.5	170	180.5	191	201.5	212	222.5
L ₂	27.5	38	48.5	59	69.5	80	90.5	101	111.5	122	132.5	143	153.5	164	174.5	185	195.5	206	216.5

Series SY100

S41 Type Manifold: Side Ported/SS3Y1-S41-Station-M3/M5-Q

Grommet (G), (H)

In case of M5

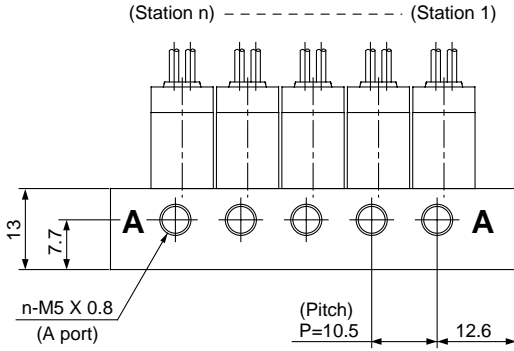

In case of M3

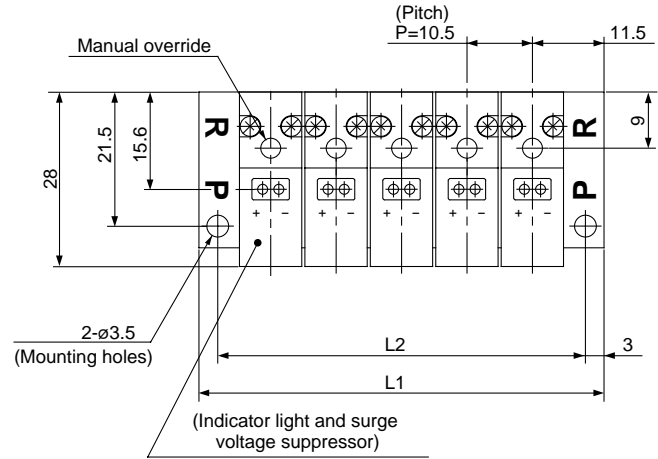
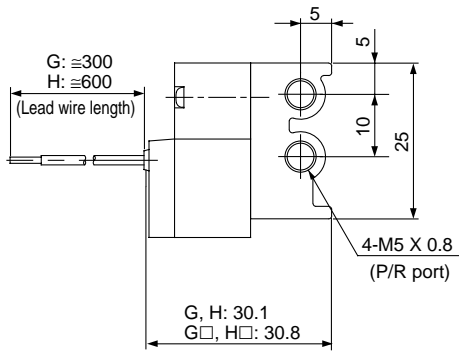
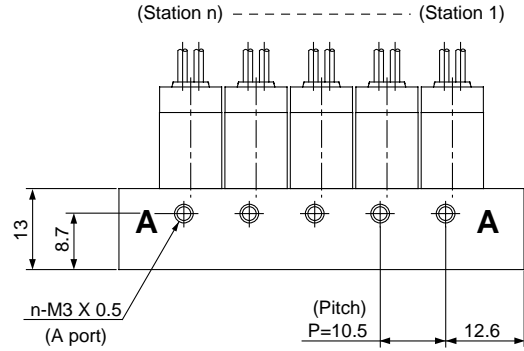

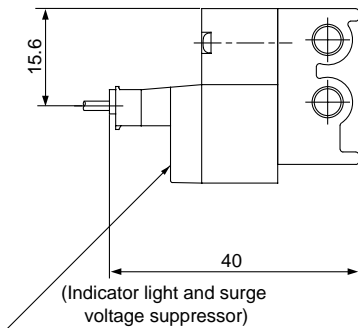

L plug connector (L)

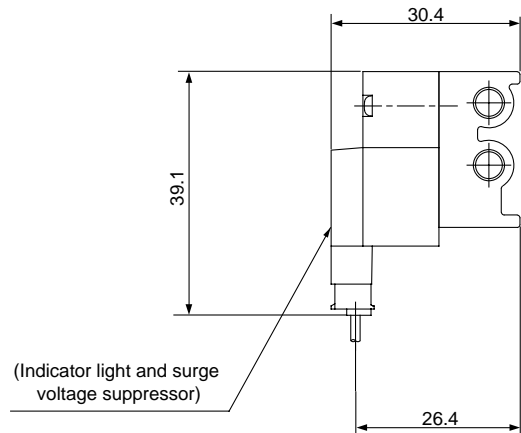

M plug connector (M)



 * Other dimensions are same as grommet style.

 * Other dimensions are same as grommet style.

Station	2	3	4	5	6	7	8	9	10	11	12	13	14	15	16	17	18	19	20
L1	33.5	44	54.5	65	75.5	86	96.5	107	117.5	128	138.5	149	159.5	170	180.5	191	201.5	212	222.5
L2	27.5	38	48.5	59	69.5	80	90.5	101	111.5	122	132.5	143	153.5	164	174.5	185	195.5	206	216.5

Series SY Made to Order

(Contact SMC for further specifications, dimensions and delivery lead time.)



Power Saver

Power consumption is decreased by 1/3 of standard product by reducing electrical power at holding. (This is effective when energizing time exceeds 62ms at rated voltage of 24V DC.)

Specifications

Series		SY1 ¹ ₂ ³ ₄ T	SY1 ¹ ₂ ³ ₄ AT
Coil rated voltage (V)		24, 12V DC	
Power consumption (W)	Inrush	0.55	0.8
	Holding	0.22	0.3

Specifications except those mentioned above are same at standard.

How to Order

Body ported SY1 1 3 T- 5 L Z - M3 -

Base mounted SY1 1 4 T- 5 M Z -

Actuation

1	Normally closed
2	Normally open

Option

-	Standard
A	Large flow capacity style

Rated voltage

5	24V DC
6	12V DC

• Enter in the same way as standard models.

Operating principle

Power consumption at holding is decreased with the below indicated circuit, for energy savings. Refer to electrical power wave form shown below.

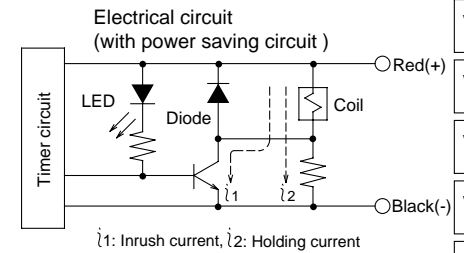

<Electrical wave form of power saving style, SY1¹₂³₄T>

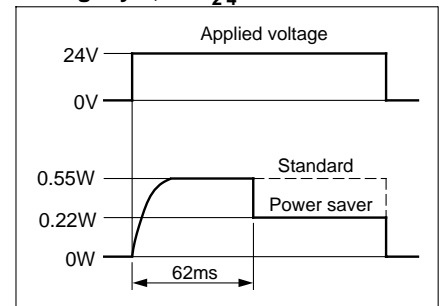

<Electrical wave form of power saving style, SY1¹₂³₄AT>

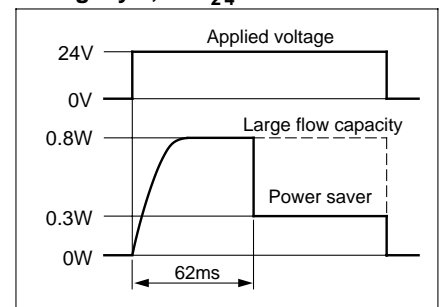

SY

SYJ

VK

VZ

VT

VT

VP

VG

VQ

VQZ

X-ON Electronics

Largest Supplier of Electrical and Electronic Components

Click to view similar products for [smc manufacturer](#):

Other Similar products are found below :

[G46-10-02-LN](#) [AC20A-F01-A](#) [AC20A-F02C-A](#) [AFM20-F02C-A](#) [AKM2000-F02-A](#) [AL40-F06-A](#) [AN20-02](#) [AN800-14](#) [ANA1-02](#) [ANA1-04](#)
[AR20-F02H-A](#) [AR30-F03H-A](#) [EAV4000-F04-5YO-Q](#) [AW20-F01H-A](#) [AW20-F02H-A](#) [AW30-F03H-A](#) [KQ2E23-00NJ](#) [KQ2L02-M3G](#)
[KQ2Z06-02AS](#) [KQ2ZT10-02AS](#) [AFD20-F02C-A](#) [SY5220-5DO-01F-Q](#) [SY7220-5DO-02F-Q](#) [SY9320-5YO-C10F-Q](#) [T0425BU-20](#) [T0425Y-](#)
[20](#) [T1075W-100](#) [T1075W-20](#) [T1075Y-20](#) [T1209R-20](#) [AN110-01](#) [AN30-03](#) [AN500-06](#) [AR20-F01H-A](#) [TIA01W-20](#) [TU0212BU-20](#)
[TU0212R-20](#) [TU0604B-100](#) [TU0604C-100](#) [TU0604G-20](#) [TU0604Y-20](#) [TU0604YR-100](#) [TU0604YR-20](#) [TU0805G-20](#) [TU0805YR-20](#)
[TU1065C-100](#) [TU1610C-20](#) [KQ2D06-02AS](#) [KQ2LU06-02AS](#) [KQ2N06-M5A](#)