



200kHz, 1A PWM Buck DC/DC Converter

Features

- Adjustable Output Voltage:
From 0.745V to 24V
- Fixed switching frequency of 200kHz
- Thermal-shutdown and current-limit protection.
- ON/OFF shutdown control input.
- Short Circuit Protection (SCP).
- Operating voltage up to 26V.
- Output load current up to 1A.
- Low-power standby mode.
- Built-in switching transistor on chip.
- SO-8 or 5-Lead SOT-23 packages
- RoHS-compliant, halogen-free.

Description

The APE1723 series are monolithic ICs designed as a step-down DC/DC converter, and have the ability to drive a 1A load without an external transistor, saving board space. The external shutdown function can be controlled with logic level signals to put the device into standby mode. The internal compensation provides feedback control for good line and load regulation without external components. Thermal shutdown is provided to prevent damage from over-temperature operation, and current limiting is available to protect the output switch. If the APE1723's VFB is taken below 0.5V, the switching frequency will be reduced. The APE1723 operates at a fixed switching frequency of 200kHz allowing smaller sized filter components. Other features include a guaranteed $\pm 3\%$ tolerance on output voltage under specified input voltage and output load conditions. The APE1723 is available in a SOT-23-5 or SO-8 package.

Typical Application

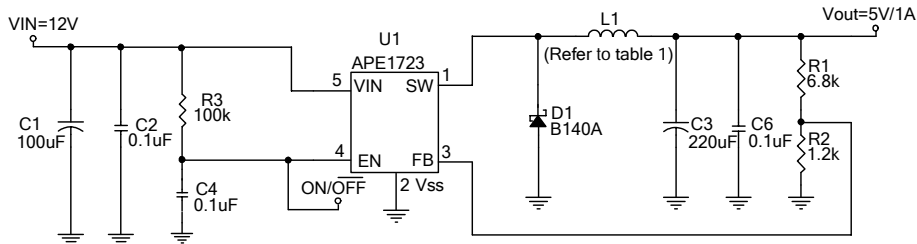

$$V_{OUT} = V_{FB} \times (1 + R1/R2), \quad V_{FB} = 0.745V, \quad R2 = 0.75k\Omega \sim 4k\Omega$$

Ordering information

APE1723XX-HF-3TR ← Packing Type:
TR: Tape and reel

Package Type: ↑
M: SO-8
Y5 : SOT-23-5

Examples:

APE1723M-HF-3TR in RoHS-compliant, halogen-free SO-8, shipped on tape and reel (3000 pcs/reel).

APE1723Y5-HF-3TR in RoHS-compliant, halogen-free SOT23-5, shipped on tape and reel (3000 pcs/reel).



Absolute Maximum Ratings (at $T_A = 25^{\circ}\text{C}$)

Maximum Supply Voltage(V_{IN})	-----	+30V
Feedback PIN Voltage(V_{FB})	-----	-0.3V to 12V
ON/OFF PIN Voltage(V_{EN})	-----	-0.3V to V_{IN}
Output Voltage to Ground(V_{OUT})	-----	-0.8V
Power Dissipation(P_D)	-----	$(T_J - T_A)/R_{th_{JA}}$ W
Storage Temperature Range(T_{ST})	-----	-65°C To 150°C
Operating Junction Temperature Range(T_{OPJ})	-----	-40°C To 125°C
Operating Supply Voltage(V_{OP})	-----	+4.5V to 26V
Thermal Resistance from Junction to Case($R_{th_{JC}}$)		
	SO-8	50°C/W
	SOT-23-5	180°C/W
Thermal Resistance from Junction to Ambient($R_{th_{JA}}$)		
	SO-8	120°C/W
	SOT-23-5	250°C/W

Note. $R_{th_{JA}}$ is measured with the PCB copper area (must be connected to V_{SS} pins) of approx. 1.5 in² (multi-layer)

Electrical Characteristics

($V_{CC}=12\text{V}$, $V_{OUT}=3.3\text{V}$, $I_{LOAD}=0.3\text{A}$, $T_A=25^{\circ}\text{C}$, unless otherwise specified)

Parameter	SYM	TEST CONDITION	MIN	TYP	MAX	UNITS
Feedback Voltage	V_{FB}	$I_{OUT}=0.3\text{A}$	0.723	0.745	0.767	V
Quiescent Current	I_Q	$V_{FB}=1.2\text{V}$ force driver off	-	3.5	6	mA
Feedback Bias Current	I_{FB}	$I_{OUT}=0.1\text{A}$	-	-10	-50	nA
Shutdown Supply Current	I_{SD}	$V_{EN}=0\text{V}$	-	2	10	uA
Oscillator Frequency	F_{OSC}		140	200	260	kHz
Oscillator Frequency of Short-Circuit Protection	F_{SCP}	(Adjustable) When $V_{FB}<0.5\text{V}$	-	50	-	kHz
Max. Duty Cycle (ON)	DC	$V_{FB}=1.2\text{V}$ force driver off	-	0	-	%
Min. Duty Cycle (OFF)		$V_{FB}=0\text{V}$ force driver on	-	100	-	
Current Limit	I_{LIMIT}	Pear current, No outside circuit $V_{FB}=0\text{V}$ force driver on	1.2	-	-	A
Saturation Voltage	V_{SAT}	$I_{OUT}=1\text{A}$, No outside circuit $V_{FB}=0\text{V}$ force driver on	-	1.2	1.5	V
SW Pin=0V	SW Pin Leakage current	I_{SWL} $V_{IN}=26\text{V}$, No outside circuit $V_{FB}=1.0\text{V}$ force driver off	-	-	-200	uA
SW Pin=-0.8V			-	-5	-	mA
EN Pin Logic Input Threshold Voltage	V_{IH}	High (regulator ON)	-	-	2	V
	V_{IL}	Low (regulator OFF)	0.5	-	-	
EN Pin Logic Input Current	I_H	$V_{EN}=2.5\text{V}$ (ON)	-	20	-	uA
EN Pin Input Current	I_L	$V_{EN}=0.3\text{V}$ (OFF)	-	-5	-	
Thermal Shutdown Temp	TSD		-	145	-	°C

THIS PRODUCT IS SENSITIVE TO ELECTROSTATIC DISCHARGE, PLEASE HANDLE WITH CAUTION.

USE OF THIS PRODUCT AS A CRITICAL COMPONENT IN LIFE SUPPORT OR OTHER SIMILAR SYSTEMS IS NOT AUTHORIZED.

APEC DOES NOT ASSUME ANY LIABILITY ARISING OUT OF THE APPLICATION OR USE OF ANY PRODUCT OR CIRCUIT DESCRIBED HEREIN; NEITHER DOES IT CONVEY ANY LICENSE UNDER ITS PATENT RIGHTS, NOR THE RIGHTS OF OTHERS.

APEC RESERVES THE RIGHT TO MAKE CHANGES WITHOUT FURTHER NOTICE TO ANY PRODUCTS HEREIN TO IMPROVE RELIABILITY, FUNCTION OR DESIGN.



Block Diagram

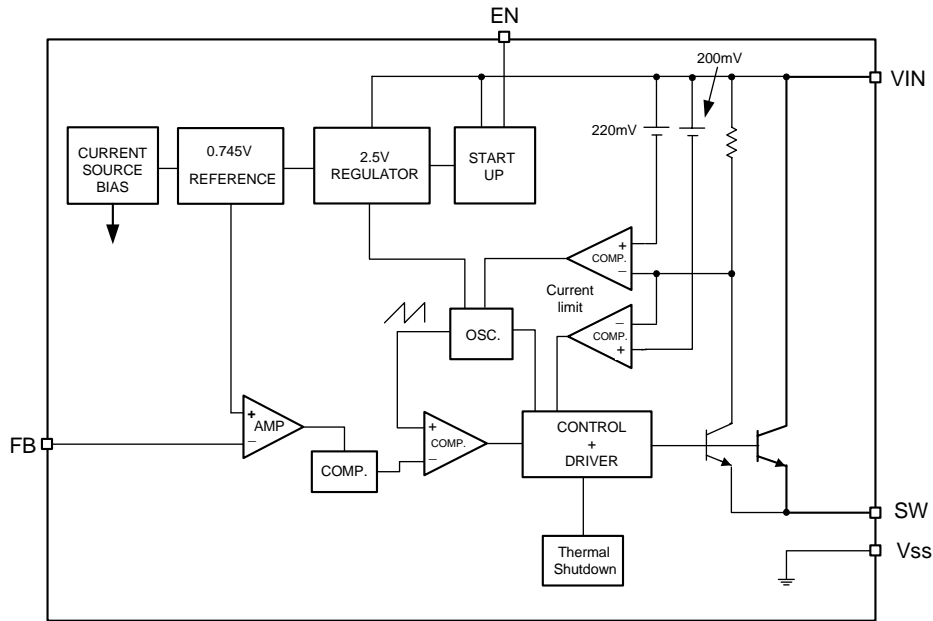

Pin Assignment

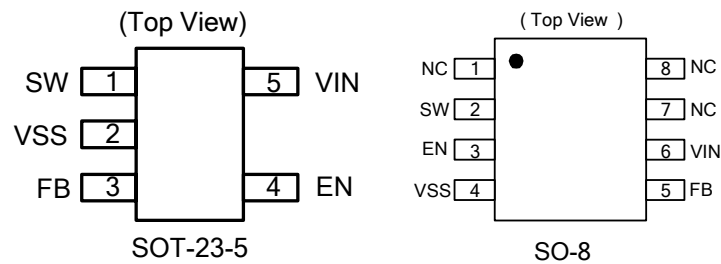

PIN SYMBOL	PIN DESCRIPTION
V _{SS}	GND Pin
FB	Feedback Pin
EN	Power -Off Pin H : Normal Operation(Step-down) L : Step-down Operation Stopped (All circuits deactivated)
SW	Switch Output
V _{IN}	Operating Voltage Input
NC	No Connect Pin



Functional Pin Descriptions

VIN

This is the positive input supply for the IC switching regulator. A suitable input bypass capacitor must be connected at this pin to minimize voltage transients and to supply the switching currents needed by the regulator.

VSS

Circuit ground.

SW

Internal switch. The voltage at this pin switches between $(+V_{IN} - V_{SAT})$ and approximately $-0.5V$, with a duty cycle of approximately V_{OUT} / V_{IN} . To minimize coupling to sensitive circuitry, the PC board copper area connected to this pin should be minimized.

FB

Senses the regulated output voltage to complete the feedback loop.

EN

Allows the switching regulator circuit to be shutdown using logic level signals, thus dropping the total input supply current to approximately $10\mu A$. Pulling this pin below a threshold voltage of approximately $0.5V$ shuts the regulator down, and pulling this pin above $2.0V$ (up to a maximum of V_{IN}) turns the regulator on.



Typical Application

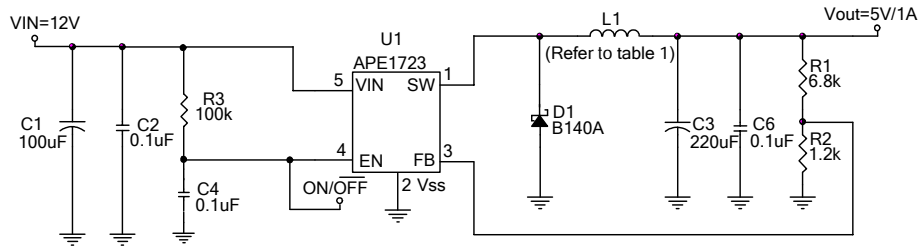

$$V_{OUT} = V_{FB} \times (1 + R1/R2), \quad V_{FB} = 0.745V, \quad R2 = 0.75k\Omega \sim 4k\Omega$$

Table 1: Resistor selection for setting the output voltage

V _{OUT}	R2	R1
5V	1.2kΩ	6.8kΩ
3.3V	2.4kΩ	8.2kΩ
2.5V	2kΩ	4.7kΩ
1.8V	3.3kΩ	4.7kΩ
1.5V	2kΩ	2kΩ
1.3V	2kΩ	1.5kΩ
1.2V	2kΩ	1.2kΩ

L1 recommended value (V _{IN} =12V, I _{OUT} =1A)				
V _{OUT}	1.8V	2.5V	3.3V	5V
L1 Value	33uH	33uH	47uH	47uH



Typical Characteristics

V_{FB} vs. I_{out}
(V_{in}=12V)

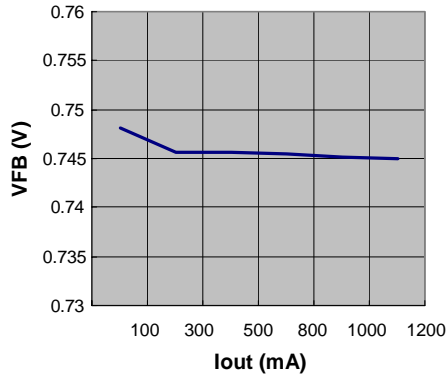

V_{FB} vs. Temperature
(V_{in}=12V, I_{out}=300mA)

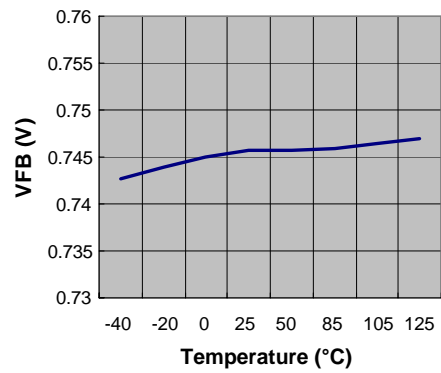

I_{ccq} vs. V_{in}

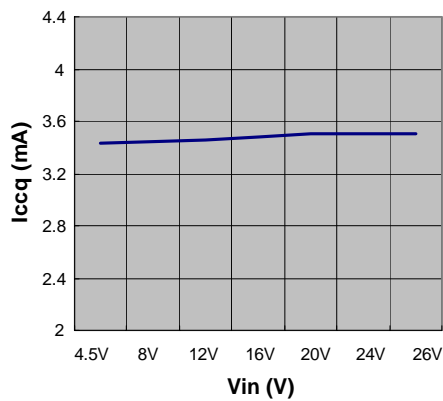

I_{ccq} vs. Temperature
(V_{in}=12V)

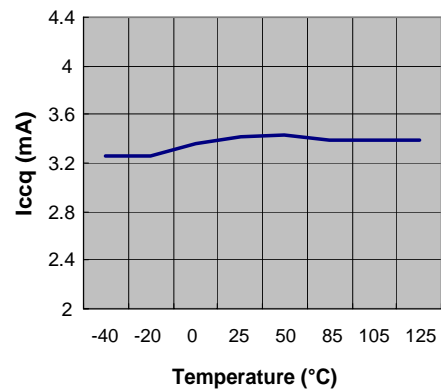

Frequency vs. V_{in}

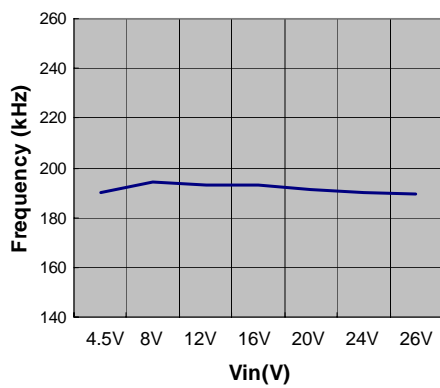

Frequency vs. Temperature
(V_{in}=12V, I_{out}=300mA)

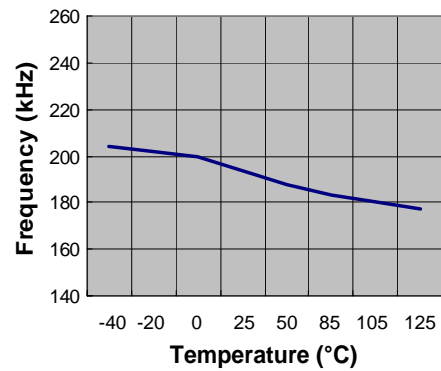



Typical Characteristics

F_{scp} vs. V_{in}

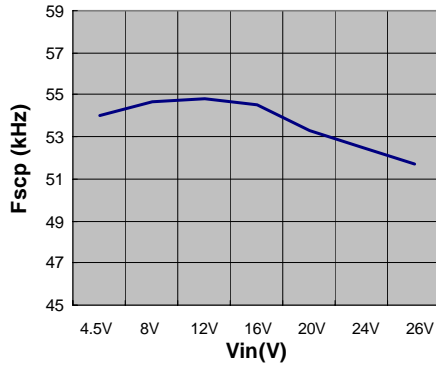

**F_{scp} vs. Temperature
(V_{in}=12V)**

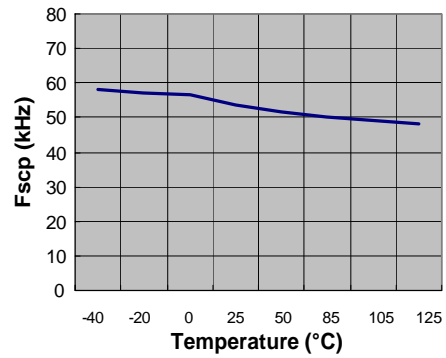

Current Limit vs. V_{in}

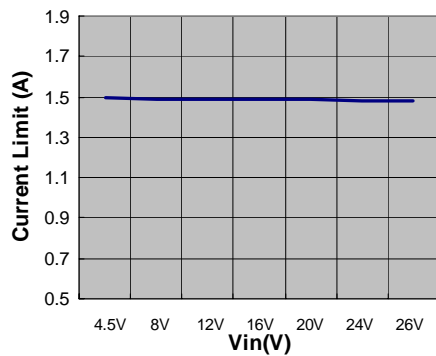

**Current Limit vs. Temperature
(V_{in}=12V)**

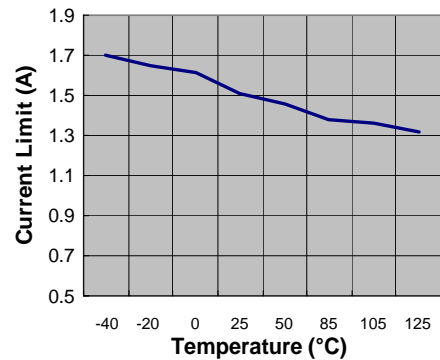

**Saturation Voltage vs. I_{out}
(V_{in}=12V)**

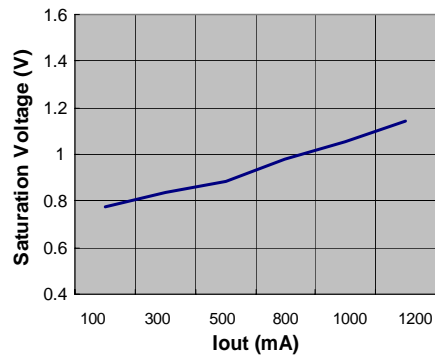

**I_{shutdown} vs. Temperature
(V_{in}=12V)**

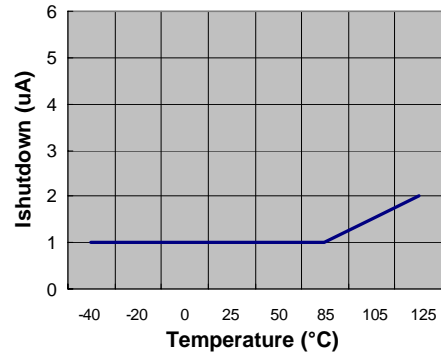



Typical Characteristics

Efficiency vs. I_{out}

($V_{in}=8V$, $V_{out}=5V$)

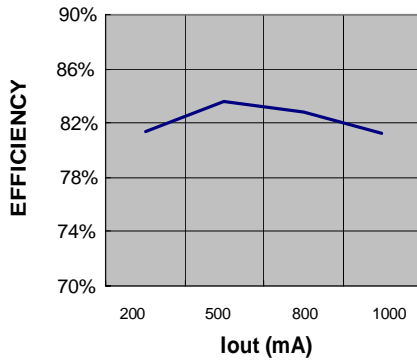

Efficiency vs. I_{out}

($V_{in}=12V$, $V_{out}=5V$)

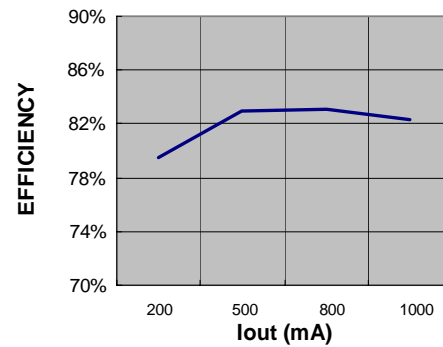

Output Ripple ($V_{in}=12V$, $V_{out}=5V$, $I_{out}=1A$)

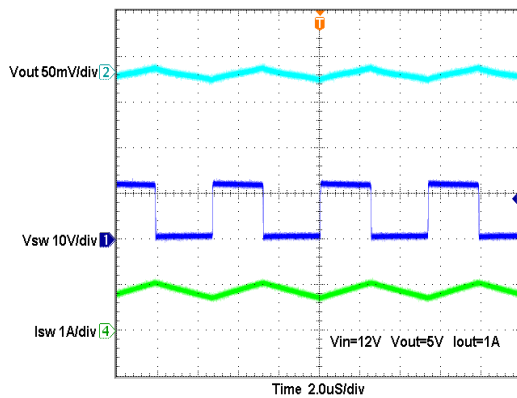

Output Ripple ($V_{in}=24V$, $V_{out}=5V$, $I_{out}=1A$)

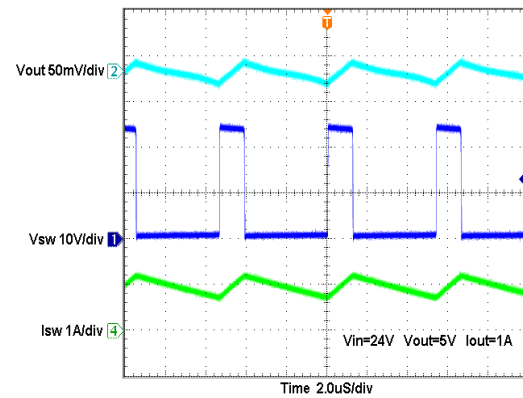

EN Off to ON Test ($V_{in}=12V$, $V_{out}=5V$, $I_{out}=1A$)

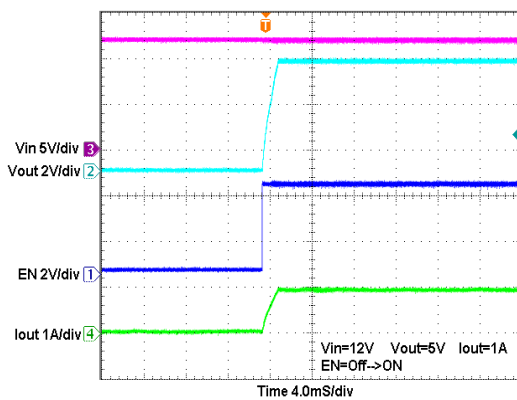

EN Off to ON Test ($V_{in}=24V$, $V_{out}=5V$, $I_{out}=1A$)

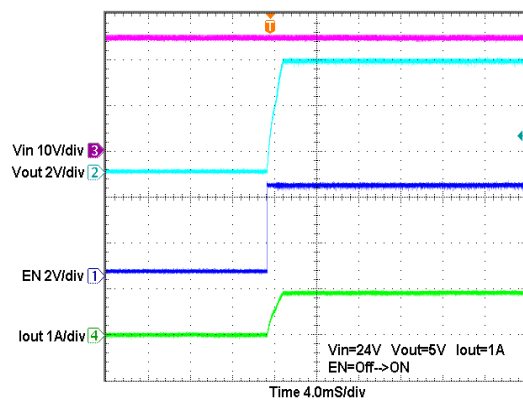



Typical Characteristics

Load Transient ($V_{in}=12V$, $V_{out}=5V$, $I_{out}=0.1\sim 1A$)

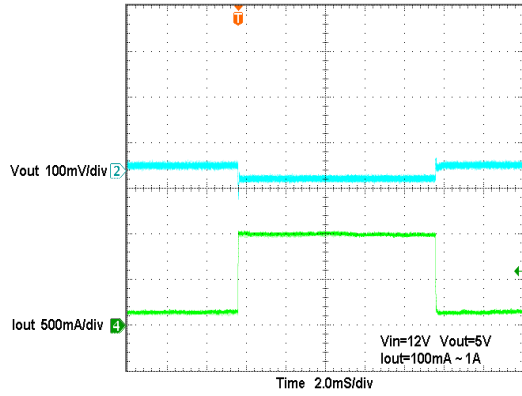

Load Transient ($V_{in}=24V$, $V_{out}=5V$, $I_{out}=0.1\sim 1A$)

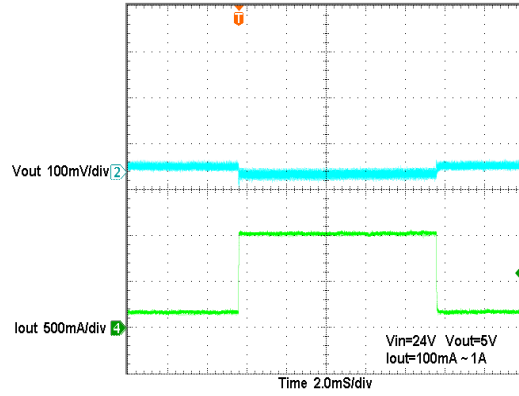



Package Dimensions: SO-8

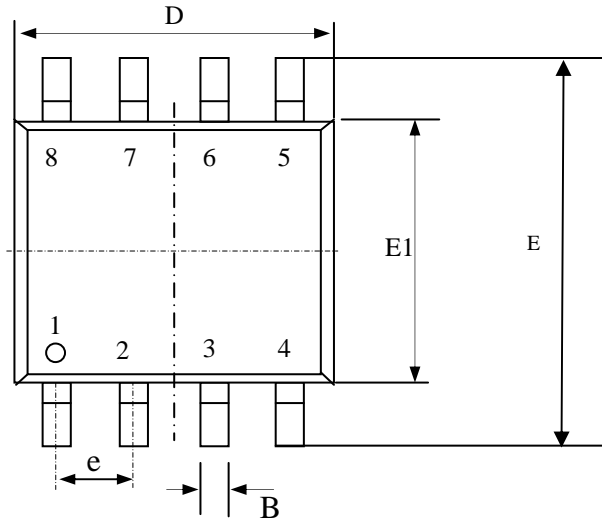

SYMBOLS	Millimeters		
	MIN	NOM	MAX
A	1.35	1.55	1.75
A1	0.10	0.18	0.25
B	0.33	0.41	0.51
C	0.19	0.22	0.25
D	4.80	4.90	5.00
E1	3.80	3.90	4.00
E	5.80	6.15	6.50
L	0.38	0.71	1.27
θ	0	4.00	8.00
e	1.27 TYP		

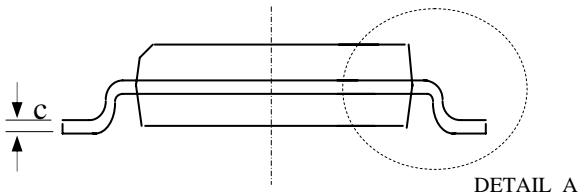
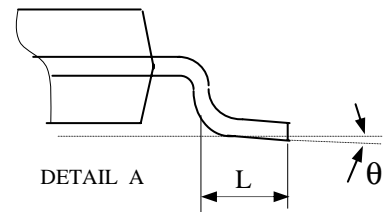
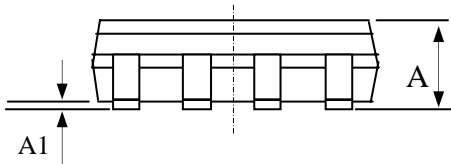

1. All dimensions are in millimeters.
2. Dimensions do not include mold protrusions.

Marking Information:

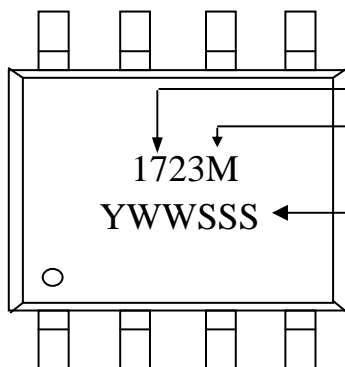

Product : APE1723
 Package:
 M = RoHS-compliant halogen-free SO-8
 Date/lot code (YWWSSS)
 Y: Last digit of the year
 WW: Work week
 SSS: Lot code sequence



Package Dimensions: SOT-23-5L

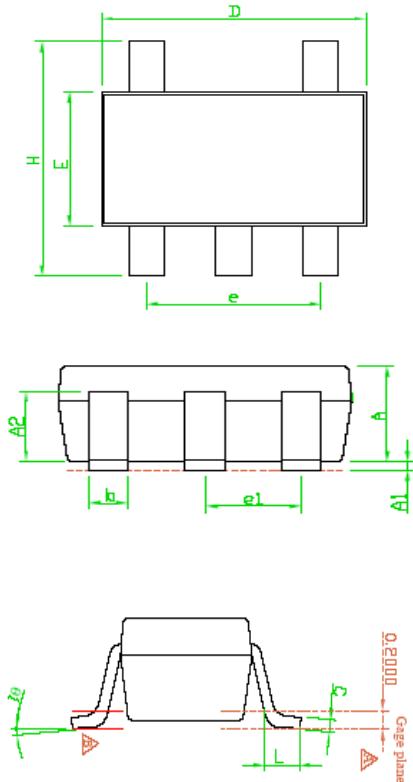

SYMBOLS	Millimeters		
	MIN	NOM	MAX
A	1.00	1.10	1.30
A1	0.00	---	0.10
A2	0.70	0.80	0.90
b	0.35	0.40	0.50
C	0.10	0.15	0.25
D	2.70	2.90	3.10
E	1.50	1.60	1.80
e	---	1.90(TYP)	---
H	2.60	2.80	3.00
L	0.37	---	---
$\theta 1$	1°	5°	9°
e2	---	0.95(TYP)	---

Note 1: Package body sizes exclude mold flash protrusions or gate burrs.

Note 2: Tolerance ± 0.1000 mm (4mil) unless otherwise specified.

Note 3: Coplanarity: 0.1000 mm

Note 4: Dimension L is measured in gage plane.

Marking Information

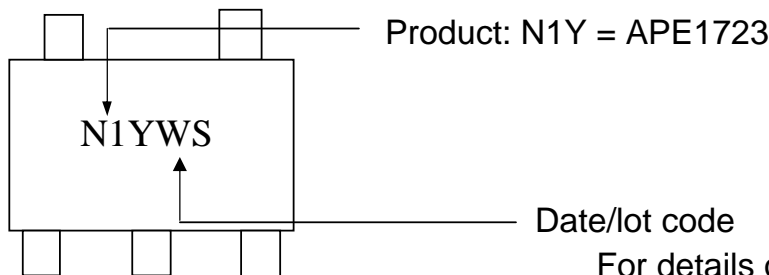

Date/lot code

For details of how to convert this to standard YYWW date code format, please contact us directly.