

Das Werkzeug für
bessere Arbeitsergebnisse.



Wera tools for better working results.

Together with its more than 600 employees and in just over 70 years, the company with its main office at Wuppertal, Germany has developed into one of the world's leading manufacturers of quality wrenches and screwdrivers for the professional.

Developments and production is state-of-the-art and fully incorporates the most recent know-how in the fields of metallurgy and process technology. The process-oriented quality assurance system ensures for a multiple level of security and exceeds the requirements of DIN EN 9001. The consequence of this is that the rate of claims is close to zero.



**What can
take you beyond
the limit?**



Wera Werk
Korzerter Straße 21-25
42349 Wuppertal · Germany
Fon +49(0)202 /40 45-322
Fax +49(0)202 /40 36 34
www.wera.de
info@wera.de

GB/D 05500243001 · 02.08 · Printed in Germany



ZYKLOP
will take
you beyond
the limit!





The new ZYKLOP ratchet from Wera – the specialist for fastening tools

No mechanic should be without a good ratchet. More still – a good ratchet is the heart and soul of every toolbox.

Wera combines the advantages of five ratchet types in just the one tool.

- + 1 fine-tooth ratchet**
- + 1 flex head ratchet**
- + 1 angle ratchet**
- + 1 nut fixing ratchet**
- + 1 power ratchet**



And more besides! The Zyklop can also be used as a screwdriver.

Why should your customers choose the Zyklop from Wera?

Not only will your customers be saving future purchase costs, they can also use the Zyklop type ratchet from Wera for all their areas of work – and this at an outstanding speed coupled with an appealingly extreme robustness.

How do you profit?

Wera has been so particularly successful over recent years because it has kept on developing high-quality innovative products providing genuine solutions to user problems. **It is therefore only consistent that in 2007 Wera was voted one of the five most innovative companies on all SME sectors in Germany.**

Wera has proved that new problem solvers lead to user investments, which in turn benefits your turnover. **In addition, a Wera brand product also helps you to achieve lucrative profit margins.**

This feeling for innovations and functioning awareness for prices and profit margins has now at last settled Wera firmly on the ratchet segment as well.

Why is the Zyklop named after the Cyclops?

The unusual design of the new Wera ratchet presents a distinctive ratchet head reminiscent of a Cyclops. Not only that, customers and users find it easy to recall such a memorable name as Zyklop. And – a Cyclops is a powerful figure of legend that practically cannot be stopped once it has picked up speed. And it is exactly this effect that makes the Zyklop from Wera so special.

The Wera Zyklop presents an appealing robustness in constant use as well and its design makes it particularly ideal for maximum rates of work – and this of course in the key sizes 1/4", 3/8", and 1/2" for all sockets, extensions, bits, and many other useful auxiliaries.

Faster than you think.



What special features can users expect?

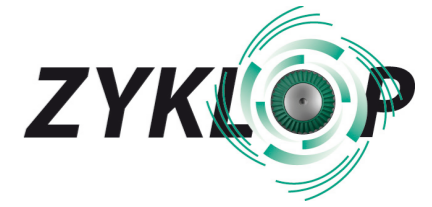

Fast turning work

Zyklop ratchets are really fast movers: **the rotating mass design accelerates the screwdriving process.** Think of a spinning top: simply give it a brief spin, and the top rotates on and on quickly and steadily. **The combination of rotating mass design and freewheel sleeve lets you turn the nut/screw quickly.** To secure the nut/screw at their final positions, switch over the lever and tighten the screw union as necessary. The nut/screw is loosened the very same way – only in reverse. The Zyklop ratchet makes your customer the king of turning work!

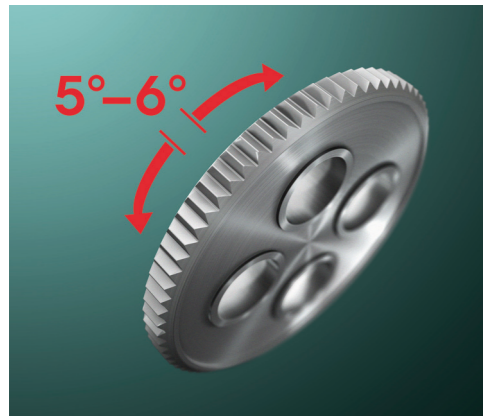

A perfect set of teeth!

With fine-pitched teeth the reversible ratchet has a small backlash angle of only 5° - 6°. The short stroke helps you to work quickly and precisely on all installation types – clockwise or anticlockwise.



Not only for nuts!

The Zyklop not only handles nuts and hex screws, **it can also take a bit at 0° for use as a completely normal screwdriver.** At the same time the typical Wera Kraffform handle provides a high transfer of forces, accelerates work, and goes gentle on the palms.

Fast connections!

The socket lock accelerates the work needed to attach and detach inserts and extensions. **The ball lock secures both sockets and accessories for reliable and safe screwdriving work.** A quick press on the release button, and tool changes are possible at all defined positions.



So, if you shy away from close contact ...

The top line extensions are fitted in addition with a flexible locking system. With this system activated, drive handles can be secured permanently to the extension. When deactivated the system allows fast changes without manual switching.

Fast connections are in high demand!

Important: **All accessory extensions are also fitted with the freewheel sleeve for accelerated work.**

Swivels by nature, if not by name!

The ratchet features a swivelling head that can be released in any position at the slide switches on both sides. This means you can work easily with your hands even in cramped or awkward spaces. The defined locking points at 0°, 90° left and right, and 15° / 90° inwards prevent the ratchet head from slipping for reliable work.

The special feature: **at the 0° position the ratchet can take a socket or the Zyklop bit holder and be used like a conventional screwdriver.**

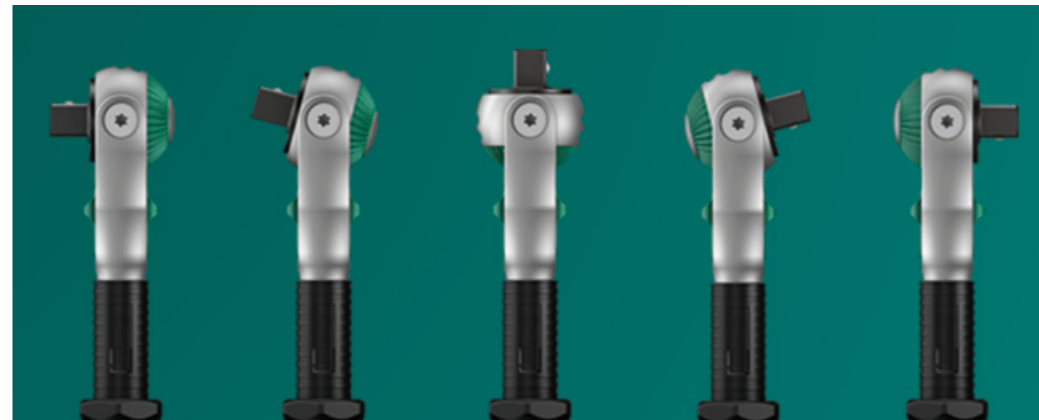

Don't switch off – switch over!

All Zyklop ratchets feature a thumbwheel that switches quickly and easily between clockwise and anticlockwise at any position. No awkward manipulation, no lost time!

For all hands!

The ratchet head presents an ergonomic design with finger recesses that respond perfectly to your hand and fingers for turning the head. **The ratchet head lies snugly in your hand for fast work.** A tool for all hands!



Nice and handy!

The Kraffform handle has been designed to fit snugly in your hand, so blisters and calluses are a thing of the past. **The hard materials used for the handle promote fast applications and prevent the skin from "sticking".** The softer, "more anti-slip" zones facilitate the zero-loss transfer of high forces.

This combination is unbeatable! So all your work is done at the flick of a wrist!



Is there any more?



The easy extension to work ...

All rigid Zyklop extensions are fitted with a freewheel sleeve. This freewheel sleeve lets you tighten and loosen screws and nuts quickly and effectively.

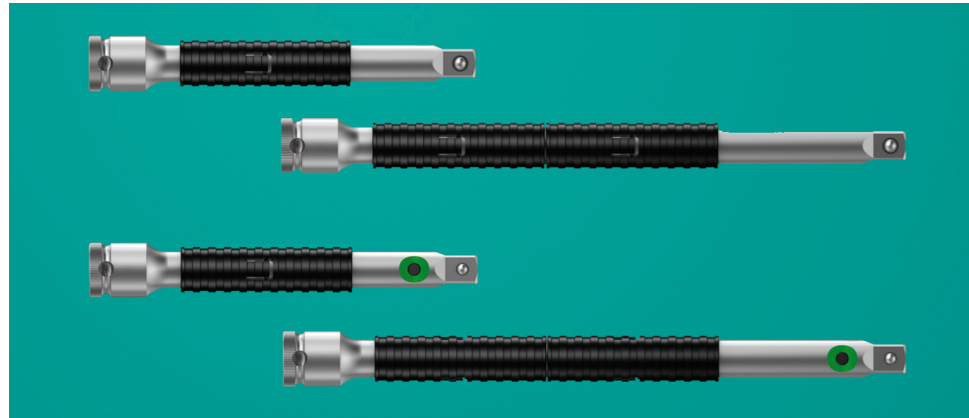

The top line extensions are additionally fitted with the flexible lock system. **With this system activated, drive handles can be attached permanently to the extension**, preventing loss and slipping. When the system is deactivated the sockets can be attached as usual and changed in a flash.

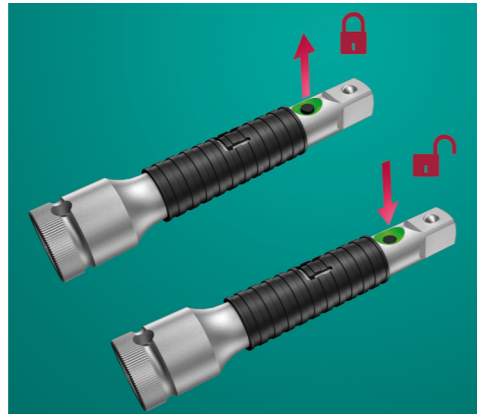

From another angle ...

The wobble extension pivots through 15° in all directions. This lets you work quickly and precisely in concealed and cramped spaces as well.



Socket to me!

Wera has taken up the latest industrial standard and developed its sockets accordingly. **The new manual and machine sockets can be used for both manual and machine work** (in most cases it is forbidden to use them with impact spanners). Users are therefore spared the need to have two sets of sockets for their work, and both transport and the screwing process are considerably simplified.

The knurling worked into the back end of the socket is ideal for manual applications. This position makes it easily accessible in every situation. In addition the groove presents a perfect mould for your fingers - for a good transfer of high forces. Reliable handling is also assured for work with oil.

Hard shell - soft core!

Wera has not only taken up individual Zyklop ratchets and sockets into its product range, but can also provide users with end-to-end solutions.

Users can choose between the basic and top lines for all three sizes (1/4", 3/8", 1/2"). Whatever the choice, it's the right one!

Wera attaches great importance to the product design. Accordingly, not only the ratchets themselves, also the Zyklop



ratchet boxes have been designed with attractive visual appeal. They are all manufactured from stable metal ideal for the workshop. **The rubber feet hold them securely in place at the workplace.**

The tools are bedded in foam so that they can be carried to and around the workplace safely and free of impacts. **The dual colour foam insert helps you to sort in the tools you no longer need quickly and reliably** - missing tools are immediately recognised (tool check system).

The tools' attachments and positions have been indelibly cut by laser into the lid for easy legibility. You can then find the tool you need with the minimum of effort.

So why all this?

So we can combat the faceless mass of cut price and cheap offers with a high profile tool set designed to thrill its users.

**The new Zyklop from Wera
Powerful and unbelievably fast.**

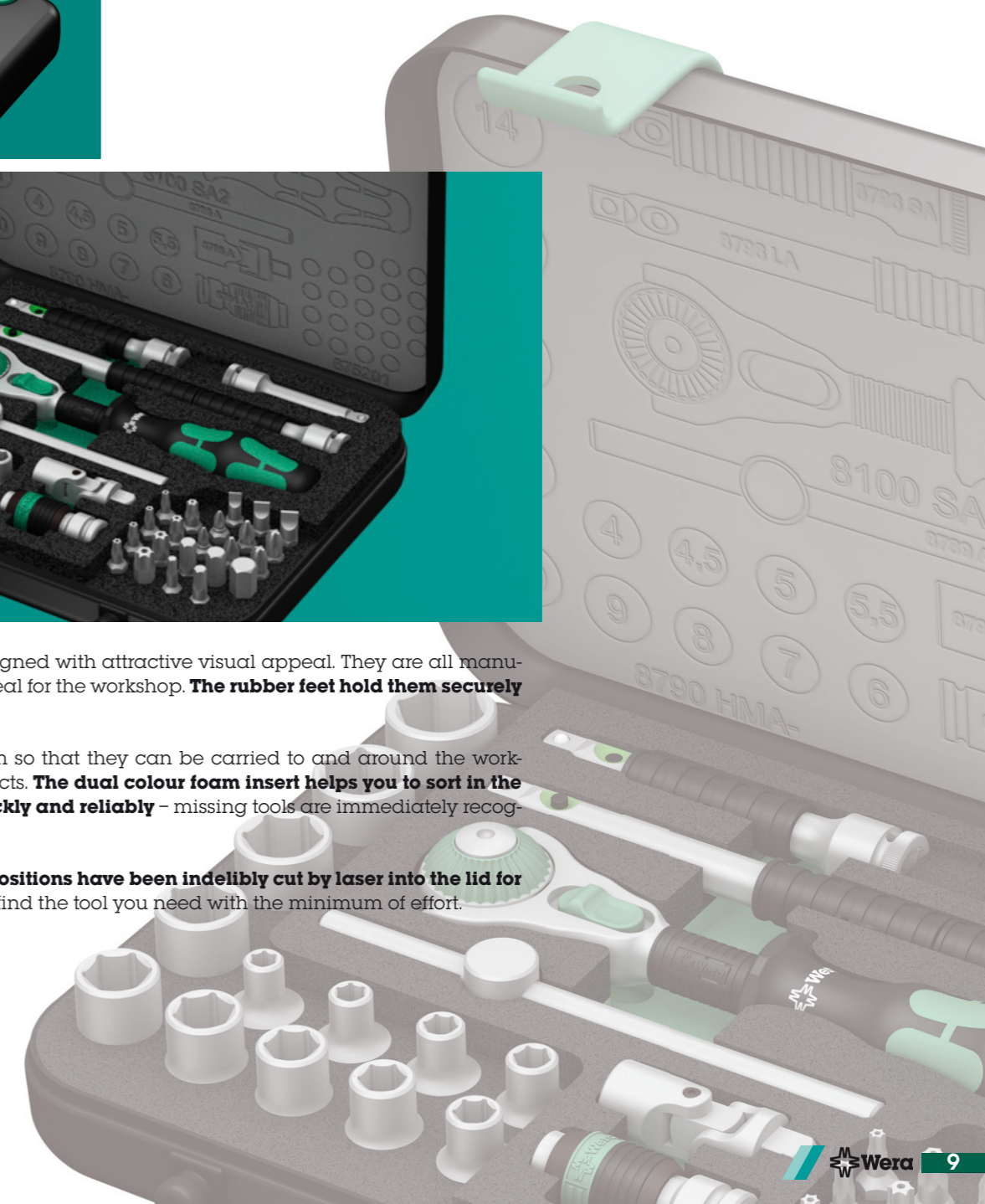

8100 SA 1 Zyklop ratchet set, 1/4"-drive, metric



18 piece set, in high-density foam-lined metal case
 1 Zyklop ratchet with 1/4" drive, 13 Zyklop sockets (metric),
 2 Zyklop extensions (short and long) with freewheel sleeve,
 1 sliding t-handle, 1 universal joint

Code	Part	Quantity
05003532001	8000 A	1 x 1/4"x152,0
	8789 A	1 x 1/4"x110,0
	8790 HMA	1 x 4,0x23,0; 1 x 4,5x23,0; 1 x 5,0x23,0; 1 x 5,5x23,0; 1 x 6,0x23,0; 1 x 7,0x23,0; 1 x 8,0x23,0; 1 x 9,0x23,0; 1 x 10,0x23,0; 1 x 11,0x23,0; 1 x 12,0x23,0; 1 x 13,0x23,0; 1 x 14,0x23,0
	8794 LA	1 x 1/4"x150,0
	8794 SA	1 x 1/4"x75,0
	8795 A	1 x 1/4"x35,5

8100 SA 2 Zyklop ratchet set, 1/4"-drive, metric



42 piece set, in high-density foam-lined metal case
 1 Zyklop ratchet with 1/4" drive, 13 Zyklop sockets (metric), 2 Zyklop
 "flexible-lock" extensions (short and long) with freewheel sleeve,
 1 wobble extension, 1 sliding t-handle, 1 universal joint, 1 adaptor
 with quick-release chuck, 22 bits

Code	Part	Quantity
05003533001	8000 A	1 x 1/4"x152,0
	800/1 Z	1 x 0,6x4,5x25; 1 x 1,0x5,5x25; x 1,2x8,0x25
	840/1 Z Hex-Plus	1 x 3,0x25; 1 x 4,0x25; 1 x 5,0x25; 1 x 6,0x25; 1 x 8,0x25
	851/1 Z PH	1 x PH 1x25; 1 x PH 2x25; 1 x PH 3x25
	855/1 Z PZ	1 x PZ 1x25; 1 x PZ 2x25; 1 x PZ 3x25
	867/1 Z TORX® BO	1 x TX 8x25; 1 x TX 9x25; 1 x TX 10x25; 1 x TX 15x25; 1 x TX 20x25; 1 x TX 25x25; 1 x TX 30x25; 1 x TX 40x25
	8784 A1	1 x 1/4"x114"x37,0
	8789 A	1 x 1/4"x110,0
	8790 HMA	1 x 4,0x23,0; 1 x 4,5x23,0; 1 x 5,0x23,0; 1 x 5,5x23,0; 1 x 6,0x23,0; 1 x 7,0x23,0; 1 x 8,0x23,0; 1 x 9,0x23,0; 1 x 10,0x23,0; 1 x 11,0x23,0; 1 x 12,0x23,0; 1 x 13,0x23,0; 1 x 14,0x23,0
	8794 A	1 x 1/4"x56,0
	8795 A	1 x 1/4"x35,5
	8796 LA	1 x 1/4"x150,0
	8796 SA	1 x 1/4"x75,0

8100 SA 3 ratchet set, 1/4"-drive, imperial



15 piece set, in high-density foam-lined metal case
 1 Zyklop ratchet with 1/4" drive, 10 Zyklop sockets (imperial),
 2 Zyklop extensions (short and long) with freewheel sleeve,
 1 sliding t-handle, 1 universal joint

Code	Part	Quantity
05003534001	8000 A	1 x 1/4"x152,0
	8789 A	1 x 1/4"x110,0
	8790 HMA	1 x 3/16"x23,0; 1 x 7/32"x23,0; 1 x 1/4"x23,0; 1 x 9/32"x23,0; 1 x 5/16"x23,0; 1 x 11/32"x23,0; 1 x 3/8"x23,0; 1 x 7/16"x23,0; 1 x 1/2"x23,0; 1 x 9/16"x23,0
	8794 LA	1 x 1/4"x150,0
	8794 SA	1 x 1/4"x75,0
	8795 A	1 x 1/4"x35,5

8100 SA 4 ratchet set, 1/4"-drive, imperial



41 piece set, in high-density foam-lined metal case
 1 Zyklop ratchet with 1/4" drive, 10 Zyklop sockets (imperial),
 2 Zyklop "flexible-lock" extensions (short and long) with freewheel
 sleeve, 1 wobble extension, 1 sliding t-handle, 1 universal joint,
 1 adaptor with quick-release chuck, 24 bits

Code	Part	Quantity
05003535001	8000 A	1 x 1/4"x152,0
	800/1 Z	1 x 0,6x4,5x25; 1 x 1,0x5,5x25; 1 x 1,2x8,0x25
	840/1 Z Hex-Plus	1 x 5/64"x25; 1 x 3/32"x25; 1 x 1/8"x25; 1 x 9/64"x25; 1 x 5/32"x25; 1 x 3/16"x25; 1 x 7/32"x25
	851/1 Z PH	1 x PH 1x25; 1 x PH 2x25; 1 x PH 3x25
	855/1 Z PZ	1 x PZ 1x25; 1 x PZ 2x25; 1 x PZ 3x25
	867/1 Z TORX® BO	1 x TX 8x25; 1 x TX 9x25; 1 x TX 10x25; 1 x TX 15x25; 1 x TX 20x25; 1 x TX 25x25; 1 x TX 30x25; 1 x TX 40x25
	8784 A1	1 x 1/4"x114"x37,0
	8789 A	1 x 1/4"x110,0
	8790 HMA	1 x 3/16"x23,0; 1 x 7/32"x23,0; 1 x 1/4"x23,0; 1 x 9/32"x23,0; 1 x 5/16"x23,0; 1 x 11/32"x23,0; 1 x 3/8"x23,0; 1 x 7/16"x23,0; 1 x 1/2"x23,0; 1 x 9/16"x23,0
	8794 A	1 x 1/4"x56,0
	8795 A	1 x 1/4"x35,5
	8796 LA	1 x 1/4"x150,0
	8796 SA	1 x 1/4"x75,0



8000 A Zyklop ratchet with 1/4" drive



Applications: For 1/4" square sockets and accessories with square drive, with ball lock

Design: Rotating mass design and handy freewheel sleeve for faster work; swivelling ratchet head; 5 defined lock positions (at 0°, and at 15°, and 90° right and left); at 0° it can be used like a conventional screwdriver; pushbutton release; CW/ACW toggle, fine-pitched tooth design, with small return angle of 5° - 6°

Handle: Multicomponent Kraftform handle for comfort and torque

Code	mm
0500350001	152,0

8790 HMA Zyklop 1/4" socket

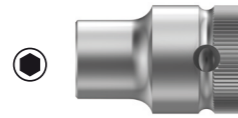

Applications: For 1/4" square drive sockets

Design: Flexible lock system for permanent interlocking or fast changes of accessories, with freewheel sleeve for ultra fast tightening or loosening of screws and nuts; chrome vanadium, brushed chromium plated finish

Code	mm	mm	mm	mm	mm	
05003501001	4,0	23,0	6,9	13,0	10,0	1
05003502001	4,5	23,0	7,5	13,0	10,0	1
05003503001	5,0	23,0	8,2	13,0	10,0	1
05003504001	5,5	23,0	8,8	13,0	10,0	1
05003505001	6,0	23,0	9,4	13,0	10,0	1
05003506001	7,0	23,0	11,0	13,0	10,0	1
05003507001	8,0	23,0	12,0	13,0	10,0	1
05003508001	9,0	23,0	13,0	14,0	10,0	1
05003509001	10,0	23,0	14,5	14,5	-	1
05003510001	11,0	23,0	16,0	15,0	13,0	1
05003511001	12,0	23,0	17,0	16,0	13,0	1
05003512001	13,0	23,0	18,0	17,0	13,0	1
05003513001	14,0	23,0	20,0	18,0	13,0	1
05003514001	3/16"	23,0	7,5	13,0	10,0	1
05003515001	7/32"	23,0	8,8	13,0	10,0	1
05003516001	1/4"	23,0	11,0	13,0	10,0	1
05003517001	9/32"	23,0	11,0	13,0	10,0	1
05003518001	5/16"	23,0	12,0	13,0	10,0	1
05003519001	11/32"	23,0	13,0	14,0	10,0	1
05003520001	3/8"	23,0	14,5	14,5	-	1
05003521001	7/16"	23,0	16,0	15,0	13,0	1
05003522001	1/2"	23,0	18,0	17,0	13,0	1
05003523001	9/16"	23,0	20,0	18,0	13,0	1

8794 SA Zyklop extension with freewheel sleeve, short, 1/4"



Applications: For 1/4" square drive sockets

Design: With handy freewheel sleeve for ultra fast tightening or loosening of screws and nuts; chrome vanadium, brushed chromium plated finish

Code	mm
05003530001	75,0

8796 LA Zyklop "flexible-lock" extension with freewheel sleeve, long, 1/4"



Applications: For 1/4" square drive sockets

Design: Flexible lock system for permanent interlocking or fast changes of accessories, with freewheel sleeve for ultra fast tightening or loosening of screws and nuts; chrome vanadium, brushed chromium plated finish

Code	mm
05003531001	150,0

8794 SA Zyklop extension with freewheel sleeve, short, 1/4"



Applications: For 1/4" square drive sockets

Design: With handy freewheel sleeve for ultra fast tightening or loosening of screws and nuts; chrome vanadium, brushed chromium plated finish

Code	mm
05003525001	75,0

8794 LA Zyklop extension with freewheel sleeve, long, 1/4"



Applications: For 1/4" square drive sockets

Design: With handy freewheel sleeve for ultra fast tightening or loosening of screws and nuts; chrome vanadium, brushed chromium plated finish

Code	mm
05003526001	150,0

8789 A Zyklop sliding t-handle, 1/4"



Applications: For 1/4" square drive sockets

Design: Sliding drive, chrome vanadium, brushed chromium plated finish

Code	mm
05003524001	110,0

8795 A Zyklop universal joint, 1/4"



Applications: For 1/4" square drive sockets

Design: Chrome vanadium/chrome molybdenum, brushed chromium plated finish

Code	mm
05003528001	35,5

8794 A Zyklop wobble extension, 1/4"



Applications: For 1/4" square drive sockets

Design: Swivels through 15°; chrome vanadium, brushed chromium plated finish

Code	mm
05003527001	56,0

8784 A1 Zyklop adaptor, 1/4"



Applications: Suitable for 1/4" hex bits under DIN 3126-C 6,3 and E 6,3, ISO 1173, and Wera series 1 and 4

Design: With quick-release chuck for fast bit changes; chromium vanadium

Code	mm
05003529001	37,0



The flexible lock system allows users to attach the drive handle permanently or change this quickly without switching manually.

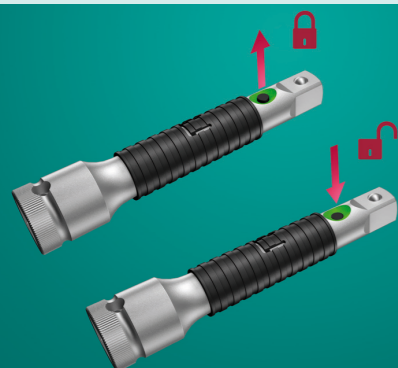

8100 SB 1 Zyklop ratchet set, 3/8"-drive, metric



23 piece set, in high-density foam-lined metal case
 1 Zyklop ratchet with 3/8" drive, 18 Zyklop sockets (metric),
 2 Zyklop extensions (short and long) with freewheel sleeve,
 1 sliding t-handle, 1 universal joint

Code	Part	Description	Quantity
05003593001	8000 B	1 x 3/8"x199,0	1
	8789 B	1 x 3/8"x165,0	
	8790 HMB	1 x 6,0x29,0; 1 x 7,0x29,0; 1 x 8,0x29,0; 1 x 9,0x29,0; 1 x 10,0x29,0; 1 x 11,0x29,0; 1 x 12,0x29,0; 1 x 13,0x29,0; 1 x 14,0x29,0; 1 x 15,0x29,0; 1 x 16,0x30,0; 1 x 17,0x30,0; 1 x 18,0x30,0; 1 x 19,0x30,0; 1 x 20,0x30,0; 1 x 21,0x30,0; 1 x 22,0x30,0; 1 x 24,0x32,0	
	8794 LB	1 x 3/8"x200,0	
	8794 SB	1 x 3/8"x125,0	
	8795 B	1 x 3/8"x50,0	

8100 SB 2 Zyklop ratchet set, 3/8"-drive, metric



43 piece set, in high-density foam-lined metal case
 1 Zyklop ratchet with 3/8" drive, 18 Zyklop sockets (metric), 2 Zyklop
 "flexible-lock" extensions (short and long) with freewheel sleeve,
 1 sliding t-handle, 1 wobble extension, 1 universal joint, 1 adaptor
 with quick-release chuck, 18 bits

Code	Part	Description	Quantity
05003594001	8000 B	1 x 3/8"x199,0	1
	800/1 Z	1 x 1,0x5,5x25	
	840/1 Z Hex-Plus	1 x 3,0x25; 1 x 4,0x25; 1 x 5,0x25; 1 x 6,0x25; 1 x 8,0x25; 1 x 10,0x25	
	851/1 Z PH	1 x PH 2x25; 1 x PH 3x25	
	855/1 Z PZ	1 x PZ 2x25; 1 x PZ 3x25	
	867/1 Z TORX® BO	1 x TX 10x25; 1 x TX 15x25; 1 x TX 20x25; 1 x TX 25x25; 1 x TX 27x25; 1 x TX 30x25; 1 x TX 40x25	
	8784 B1	1 x 1/4"x3/8"x44,0	
	8789 B	1 x 3/8"x165,0	
	8790 HMB	1 x 6,0x29,0; 1 x 7,0x29,0; 1 x 8,0x29,0; 1 x 9,0x29,0; 1 x 10,0x29,0; 1 x 11,0x29,0; 1 x 12,0x29,0; 1 x 13,0x29,0; 1 x 14,0x29,0; 1 x 15,0x29,0; 1 x 16,0x30,0; 1 x 17,0x30,0; 1 x 18,0x30,0; 1 x 19,0x30,0; 1 x 20,0x30,0; 1 x 21,0x30,0; 1 x 22,0x30,0; 1 x 24,0x32,0	
	8794 B	1 x 3/8"x76,0	
	8795 B	1 x 3/8"x50,0	
	8796 LB	1 x 3/8"x200,0	
	8796 SB	1 x 3/8"x125,0	

8100 SB 3 Zyklop ratchet set, 3/8"-drive, imperial



17 piece set, in high-density foam-lined metal case
 1 Zyklop ratchet with 3/8" drive, 12 Zyklop sockets (imperial), 2
 Zyklop extensions (short and long) with freewheel sleeve, 1 sliding
 t-handle, 1 universal joint

Code	Part	Description	Quantity
05003595001	8000 B	1 x 3/8"x199,0	1
	8789 B	1 x 3/8"x165,0	
	8790 HMB	1 x 1/4"x29,0; 1 x 5/16"x29,0; 1 x 11/32"x29,0; 1 x 3/8"x29,0; 1 x 7/16"x29,0; 1 x 1/2"x29,0; 1 x 9/16"x29,0; 1 x 5/8"x30,0; 1 x 11/16"x30,0; 1 x 3/4"x30,0; 1 x 13/16"x30,0; 1 x 7/8"x30,0	
	8794 LB	1 x 3/8"x200,0	
	8794 SB	1 x 3/8"x125,0	
	8795 B	1 x 3/8"x50,0	

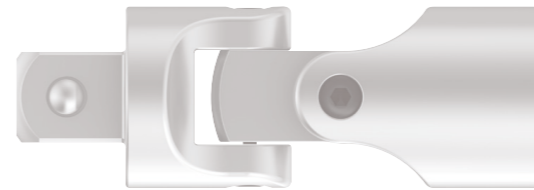

8100 SB 4 Zyklop ratchet set, 3/8"-drive, imperial



38 piece set, in high-density foam-lined metal case
 1 Zyklop ratchet with 3/8" drive, 12 Zyklop sockets (imperial), 2
 Zyklop "flexible-lock" extensions (short and long) with freewheel
 sleeve, 1 sliding t-handle, 1 wobble extension, 1 universal joint,
 1 adaptor with quick-release chuck, 19 bits

Code	Part	Description	Quantity
05003596001	8000 B	1 x 3/8"x199,0	1
	800/1 Z	1 x 1,0x5,5x25	
	840/1 Z Hex-Plus	1 x 5/64"x25; 1 x 3/32"x25; 1 x 1/8"x25; 1 x 9/64"x25; 1 x 5/32"x25; 1 x 3/16"x25; 1 x 7/32"x25	
	851/1 Z PH	1 x PH 2x25; 1 x PH 3x25	
	855/1 Z PZ	1 x PZ 2x25; 1 x PZ 3x25	
	867/1 Z TORX® BO	1 x TX 10x25; 1 x TX 15x25; 1 x TX 20x25; 1 x TX 25x25; 1 x TX 27x25; 1 x TX 30x25; 1 x TX 40x25	
	8784 B1	1 x 1/4"x3/8"x44,0	
	8789 B	1 x 3/8"x165,0	
	8790 HMB	1 x 1/4"x29,0; 1 x 5/16"x29,0; 1 x 11/32"x29,0; 1 x 3/8"x29,0; 1 x 7/16"x29,0; 1 x 1/2"x29,0; 1 x 9/16"x29,0; 1 x 5/8"x30,0; 1 x 11/16"x30,0; 1 x 3/4"x30,0; 1 x 13/16"x30,0; 1 x 7/8"x30,0	
	8794 B	1 x 3/8"x76,0	
	8795 B	1 x 3/8"x50,0	
	8796 LB	1 x 3/8"x200,0	
	8796 SB	1 x 3/8"x125,0	

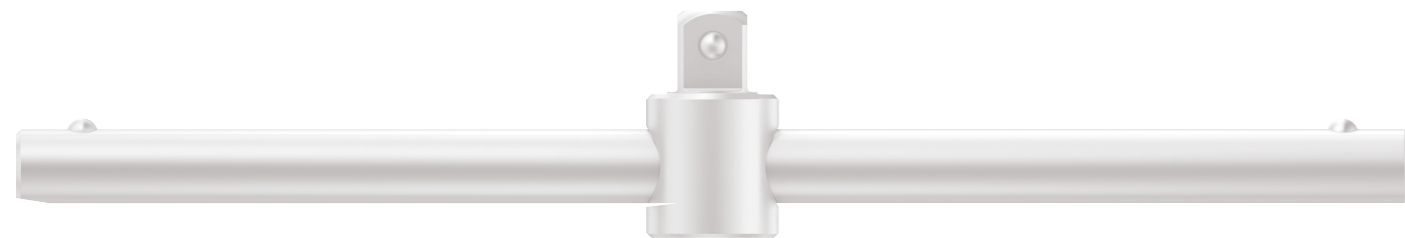

8000 B Zyklop ratchet with 3/8" drive



Applications: For 3/8" square drive sockets and accessories

Design: Rotating mass design and handy freewheel sleeve for faster work; swivelling ratchet head; 5 defined lock positions (at 0°, and at 15°, and 90° right and left); at 0° it can be used like a conventional screwdriver; pushbutton release; CW/ACW toggle, fine-pitched tooth design, with small return angle of 5° - 6°

Handle: Multicomponent Kraftform handle for comfort and torque

Code	mm		
05003550001	3/8"	199,0	1



The new manual and machine sockets can be used for both manual and machine work (in most cases it is forbidden to use them with impact spanners). Users are therefore spared the need to have two sets of sockets for their work, and both transport and the screwing process are considerably simplified.



8790 HMB Zyklop 3/8" socket



Applications: For hex-head fasteners
Design: For manual and (non-impact) machine applications, with ball intercept ring, knurling for reliable manual precision, chrome vanadium, brushed chromium plated finish

Code	mm	mm	mm	mm	mm	
05003551001	6,0	29,0	10,5	13,0	18,0	1
05003552001	7,0	29,0	11,0	13,0	18,0	1
05003553001	8,0	29,0	12,2	13,0	18,0	1
05003554001	9,0	29,0	13,5	13,0	18,0	1
05003555001	10,0	29,0	14,5	13,0	18,0	1
05003556001	11,0	29,0	16,0	13,0	18,0	1
05003557001	12,0	29,0	17,0	13,0	18,0	1
05003558001	13,0	29,0	18,5	14,0	20,0	1
05003559001	14,0	29,0	19,5	14,5	22,0	1
05003560001	15,0	29,0	21,0	15,0	24,0	1
05003561001	16,0	30,0	22,0	16,0	24,0	1
05003562001	17,0	30,0	23,5	17,0	24,0	1
05003563001	18,0	30,0	24,5	18,0	24,0	1
05003564001	19,0	30,0	26,0	13,0	24,0	1
05003565001	20,0	30,0	28,0	13,0	25,0	1
05003566001	21,0	30,0	28,0	13,0	25,0	1
05003567001	22,0	30,0	32,0	13,0	25,0	1
05003568001	24,0	32,0	32,0	13,0	25,0	1
05003569001	1/4"	29,0	11,0	18,0	12,0	1
05003570001	5/16"	29,0	12,2	18,0	12,0	1
05003571001	11/32"	29,0	13,5	18,0	12,0	1
05003572001	3/8"	29,0	14,5	18,0	12,0	1
05003573001	7/16"	29,0	16,0	18,0	12,0	1
05003574001	1/2"	29,0	18,5	20,0	12,0	1
05003575001	9/16"	29,0	19,5	22,0	12,0	1
05003576001	5/8"	30,0	22,0	24,0	12,0	1
05003577001	11/16"	30,0	23,0	24,0	18,0	1
05003578001	3/4"	30,0	26,0	24,0	18,0	1
05003579001	13/16"	30,0	28,0	25,0	18,0	1
05003580001	7/8"	30,0	32,0	25,0	18,0	1

8796 SB Zyklop "flexible-lock" extension with freewheel sleeve, short, 3/8"



Applications: For 3/8" square drive sockets
Design: Flexible lock system for permanent interlocking or fast changes of accessories, with freewheel sleeve for ultra fast tightening or loosening of fasteners; chrome vanadium, brushed chromium plated finish

Code	mm		
05003591001	3/8"	125,0	1

8796 LB Zyklop "flexible-lock" extension with freewheel sleeve, long, 3/8"



Applications: For 3/8" square drive sockets
Design: Flexible lock system for permanent interlocking or fast changes of accessories, with freewheel sleeve for ultra fast tightening or loosening of fasteners; chrome vanadium, brushed chromium plated finish

Code	mm		
05003592001	3/8"	200,0	1

8794 SB Zyklop extension with freewheel sleeve, short, 3/8"



Applications: For 3/8" square drive sockets
Design: With handy freewheel sleeve for ultra fast tightening or loosening of fasteners; chrome vanadium, brushed chromium plated finish

Code	mm		
05003582001	3/8"	125,0	1

8794 LB Zyklop extension with freewheel sleeve, long, 3/8"



Applications: For 3/8" square drive sockets
Design: With handy freewheel sleeve for ultra fast tightening or loosening of fasteners; chrome vanadium, brushed chromium plated finish

Code	mm		
05003583001	3/8"	200,0	1

8789 B Zyklop sliding t-handle, 3/8"



Applications: For 3/8" square drive sockets
Design: Sliding drive, chrome vanadium, brushed chromium plated finish

Code	mm		
05003581001	3/8"	165,0	1

8795 B Zyklop universal joint, 3/8"

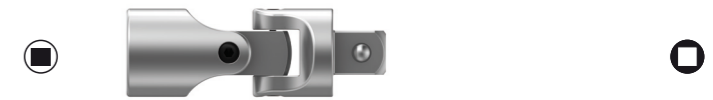

Applications: For 3/8" square drive sockets
Design: Chrome vanadium/chrome molybdenum, brushed chromium plated finish

Code	mm		
05003585001	3/8"	50,0	1

8794 B Zyklop wobble extension, 3/8"



Applications: For 3/8" square drive sockets
Design: Swivels through 15°; chrome vanadium, brushed chromium plated finish

Code	mm		
05003584001	3/8"	76,0	1

8784 B1 Zyklop adaptor, 3/8"



Applications: Suitable for 1/4" hex bits under DIN 3126-C 6,3 and E 6,3, ISO 1173, and Wera series 1 and 4
Design: With quick-release chuck for fast bit changes; chromium vanadium

Code	mm		
05003590001	1/4"	3/8"	44,0

8100 SC 1 Zyklop ratchet set, 1/2"-drive, metric



22 piece set, in high-density foam-lined metal case
1 Zyklop ratchet with 1/2" drive, 17 Zyklop sockets (metric),
2 Zyklop extensions (short and long) with freewheel sleeve,
1 sliding t-handle, 1 universal joint

Code	Icon	Part Name	Quantity
05003644001	○	8000 C	1 x 1/2"x277,0
	○	8789 C	1 x 1/2"x250,0
	●	8790 HMC	1 x 10,0x37,0; 1 x 11,0x37,0; 1 x 12,0x37,0; 1 x 13,0x37,0; 1 x 14,0x37,0; 1 x 15,0x37,0; 1 x 16,0x37,0; 1 x 17,0x37,0; 1 x 18,0x37,0; 1 x 19,0x37,0; 1 x 20,0x37,0; 1 x 21,0x37,0; 1 x 22,0x37,0; 1 x 24,0x37,0; 1 x 27,0x40,0; 1 x 30,0x42,0; 1 x 32,0x42,0
	○	8794 LC	1 x 1/2"x250,0
	○	8794 SC	1 x 1/2"x125,0
	○	8795 C	1 x 1/2"x69,0

8100 SC 2 Zyklop ratchet set, 1/2"-drive, metric



37 piece set, in high-density foam-lined metal case
1 Zyklop ratchet with 1/2" drive, 17 Zyklop sockets (metric), 2 Zyklop
"flexible-lock" extensions (short and long) with freewheel sleeve,
1 sliding t-handle, 1 wobble extension, 1 universal joint, 1 adaptor
with quick-release chuck, 13 bits

Code	Icon	Part Name	Quantity
05003645001	○	8000 C	1 x 1/2"x277,0
	○	840/2 Z Hex-Plus	1 x 5x30; 1 x 6x30; 1 x 8x30; 1 x 10x30
	+	851/2 Z PH	1 x PH 3x32
	+	855/2 Z PZ	1 x PZ 3x32
	+	867/2 Z TORX®	1 x TX 20x35; 1 x TX 25x35; 1 x TX 30x35; 1 x TX 40x35; 1 x TX 45x35; 1 x TX 50x35; 1 x TX 55x35
	○	8784 C2	1 x 1/2"x5/16"x50,0
	○	8789 C	1 x 1/2"x250,0
	●	8790 HMC	1 x 10,0x37,0; 1 x 11,0x37,0; 1 x 12,0x37,0; 1 x 13,0x37,0; 1 x 14,0x37,0; 1 x 15,0x37,0; 1 x 16,0x37,0; 1 x 17,0x37,0; 1 x 18,0x37,0; 1 x 19,0x37,0; 1 x 20,0x37,0; 1 x 21,0x37,0; 1 x 22,0x37,0; 1 x 24,0x37,0; 1 x 27,0x40,0; 1 x 30,0x42,0; 1 x 32,0x42,0
	○	8794 C	1 x 1/2"x52,0
	○	8795 C	1 x 1/2"x69,0
	○	8796 LC	1 x 1/2"x250,0
	○	8796 SC	1 x 1/2"x125,0

8100 SC 3 Zyklop ratchet set, 1/2"-drive, imperial



23 pieces set, in high-density foam-lined metal case
1 Zyklop ratchet with 1/2" drive, 18 Zyklop sockets (imperial),
2 Zyklop extensions (short and long) with freewheel sleeve,
1 sliding t-handle, 1 universal joint

Code	Icon	Part Name	Quantity
05003646001	○	8000 C	1 x 1/2"x277,0
	○	8789 C	1 x 1/2"x250,0
	●	8790 HMC	1 x 3/8"x37,0; 1 x 7/16"x37,0; 1 x 1/2"x37,0; 1 x 9/16"x37,0; 1 x 19/32"x37,0; 1 x 5/8"x37,0; 1 x 11/16"x37,0; 1 x 3/4"x37,0; 1 x 25/32"x37,0; 1 x 13/16"x37,0; 1 x 7/8"x37,0; 1 x 15/16"x37,0; 1 x 31/32"x37,0; 1 x 1"x40,0; 1 x 1 1/16"x40,0; 1 x 1 1/8"x40,0; 1 x 1 3/16"x42,0; 1 x 1 1/4"x42,0
	○	8794 LC	1 x 1/2"x250,0
	○	8794 SC	1 x 1/2"x125,0
	○	8795 C	1 x 1/2"x69,0

8100 SC 4 Zyklop ratchet set, 1/2"-drive, imperial



38 pieces set, in high-density foam-lined metal case
1 Zyklop ratchet with 1/2" drive, 18 Zyklop sockets (imperial),
2 Zyklop "flexible-lock" extensions (short and long) with freewheel
sleeve, 1 sliding t-handle, 1 wobble extension, 1 universal joint,
1 adaptor with quick-release chuck, 13 bits

Code	Icon	Part Name	Quantity
05003647001	○	8000 C	1 x 1/2"x277,0
	○	840/2 Z Hex-Plus	1 x 7/32"x30; 1 x 1/4"x30; 1 x 5/16"x30; 1 x 3/8"x30
	+	851/2 Z PH	1 x PH 3x32
	+	855/2 Z PZ	1 x PZ 3x32
	+	867/2 Z TORX®	1 x TX 20x35; 1 x TX 25x35; 1 x TX 30x35; 1 x TX 40x35; 1 x TX 45x35; 1 x TX 50x35; 1 x TX 55x35
	○	8784 C2	1 x 1/2"x5/16"x50,0
	○	8789 C	1 x 1/2"x250,0
	●	8790 HMC	1 x 3/8"x37,0; 1 x 7/16"x37,0; 1 x 1/2"x37,0; 1 x 9/16"x37,0; 1 x 19/32"x37,0; 1 x 5/8"x37,0; 1 x 11/16"x37,0; 1 x 3/4"x37,0; 1 x 25/32"x37,0; 1 x 13/16"x37,0; 1 x 7/8"x37,0; 1 x 15/16"x37,0; 1 x 31/32"x37,0; 1 x 1"x40,0; 1 x 1 1/16"x40,0; 1 x 1 1/8"x40,0; 1 x 1 3/16"x42,0; 1 x 1 1/4"x42,0
	○	8794 C	1 x 1/2"x52,0
	○	8795 C	1 x 1/2"x69,0
	○	8796 LC	1 x 1/2"x250,0
	○	8796 SC	1 x 1/2"x125,0



Every detail perfect - storage boxes for Zyklop ratchet sets. The dual colour foam insert lets you sort in your tools quickly and reliably - missing tools are immediately recognised. Attachments and positions have been cut indelibly by laser into the lid for easy legibility.

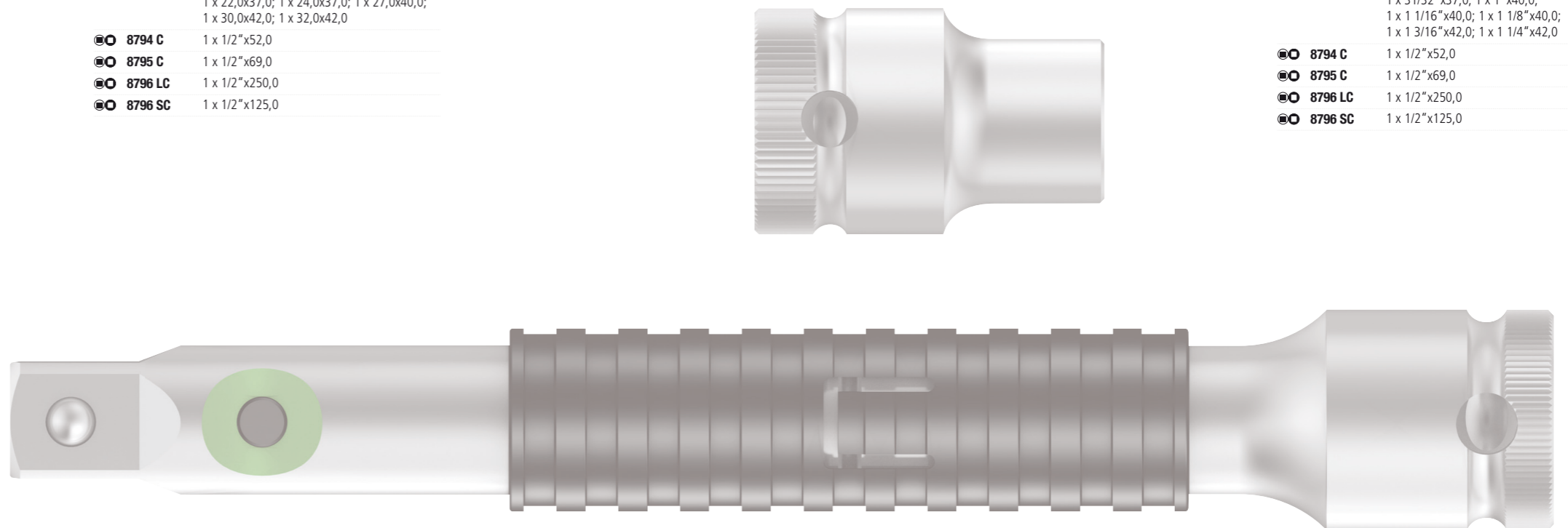

8000 C Zyklop ratchet with 1/2" drive



Applications: For 1/2" square drive sockets and accessories

Design: Rotating mass design and handy freewheel sleeve for faster work; swivelling ratchet head; 5 defined lock positions (at 0°, and at 15°, and 90° right and left); at 0° it can be used like a conventional screwdriver; pushbutton release; CW/ACW toggle, fine-pitched tooth design, with small return angle of 5° - 6°

Handle: Multicomponent Krafftform handle for comfort and torque

Code	mm	1
05003600001	1/2" 277,0	1

8790 HMC Zyklop 1/2" socket

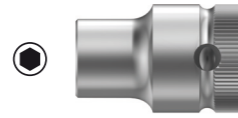

Applications: For hex-head fasteners

Design: For manual and (non-impact) machine applications, with ball intercept ring, knurling for reliable manual precision, chrome vanadium, brushed chromium plated

Code	mm	mm	mm	mm	mm	1	
05003601001	10,0	37,0	15,5	24,0	17,0	1	
05003602001	11,0	37,0	16,5	24,0	17,0	1	
05003603001	12,0	37,0	17,5	24,0	17,0	1	
05003604001	13,0	37,0	19,0	24,0	17,0	1	
05003605001	14,0	37,0	20,0	24,0	17,0	1	
05003606001	15,0	37,0	21,0	24,0	17,0	1	
05003607001	16,0	37,0	22,5	24,0	17,0	1	
05003608001	17,0	37,0	24,0	26,0	17,0	1	
05003609001	18,0	37,0	25,0	26,0	17,0	1	
05003610001	19,0	37,0	26,5	26,0	20,0	1	
05003611001	20,0	37,0	28,0	26,0	20,0	1	
05003612001	21,0	37,0	29,0	26,0	20,0	1	
05003613001	22,0	37,0	30,5	26,0	20,0	1	
05003614001	24,0	37,0	33,0	28,0	20,0	1	
05003615001	27,0	40,0	36,5	32,0	23,0	1	
05003616001	30,0	42,0	40,0	34,0	25,0	1	
05003617001	32,0	42,0	42,0	36,0	25,0	1	
05003618001		3/8"	37,0	15,5	24,0	17,0	1
05003619001		7/16"	37,0	16,5	24,0	17,0	1
05003620001		1/2"	37,0	19,0	24,0	17,0	1
05003621001		9/16"	37,0	20,0	24,0	17,0	1
05003622001		19/32"	37,0	21,0	24,0	17,0	1
05003623001		5/8"	37,0	22,5	24,0	17,0	1
05003624001		11/16"	37,0	25,5	26,0	17,0	1
05003625001		3/4"	37,0	26,5	26,0	20,0	1
05003626001		25/32"	37,0	28,0	26,0	20,0	1
05003627001		13/16"	37,0	29,0	26,0	20,0	1
05003628001		7/8"	37,0	30,5	26,0	20,0	1
05003629001		15/16"	37,0	33,0	28,0	20,0	1
05003630001		31/32"	37,0	33,0	28,0	20,0	1
05003631001		1"	40,0	36,5	32,0	23,0	1
05003632001		1 1/16"	40,0	36,5	32,0	23,0	1
05003633001		1 1/8"	40,0	40,0	34,0	23,0	1
05003634001		1 3/16"	42,0	40,0	34,0	25,0	1
05003635001		1 1/4"	42,0	42,0	36,0	25,0	1

8796 SC Zyklop "flexible-lock" extension with freewheel sleeve, short, 1/2"



Applications: For 1/2" square drive sockets

Design: Flexible lock system for permanent interlocking or fast changes of accessories, with freewheel sleeve for ultra fast tightening or loosening of fasteners; chrome vanadium, brushed chromium plated finish

Code	mm	1
05003642001	1/2" 125,0	1

8796 LC Zyklop extension "flexible-lock" with freewheel sleeve, long, 1/2"



Applications: For 1/2" square drive sockets

Design: Flexible lock system for permanent interlocking or fast changes of accessories, with freewheel sleeve for ultra fast tightening or loosening of fasteners; chrome vanadium, brushed chromium plated finish

Code	mm	1
05003643001	1/2" 250,0	1

8794 SC Zyklop extension with freewheel sleeve, short, 1/2"



Applications: For 1/2" square drive sockets

Design: With handy freewheel sleeve for ultra fast tightening or loosening of fasteners; chrome vanadium, brushed chromium plated finish

Code	mm	1
05003637001	1/2" 125,0	1

8794 LC Zyklop extension with freewheel sleeve, long, 1/2"



Applications: For 1/2" square drive sockets

Design: With handy freewheel sleeve for ultra fast tightening or loosening of fasteners; chrome vanadium, brushed chromium plated finish

Code	mm	1
05003638001	1/2" 250,0	1

8789 C Zyklop sliding t-handle, 1/2"



Applications: For 1/2" square drive sockets

Design: Sliding drive, chrome vanadium, brushed chromium plated finish

Code	mm	1
05003636001	1/2" 250,0	1

8795 C Zyklop universal joint, 1/2"



Applications: For 1/2" square drive sockets

Design: Chrome vanadium/chrome molybdenum, brushed chromium plated

Code	mm	1
05003640001	1/2" 69,0	1



The ratchet features a swivelling head that can be released in any position at the slide switches on both sides. This means you can work easily with your hands even in cramped or awkward spaces.

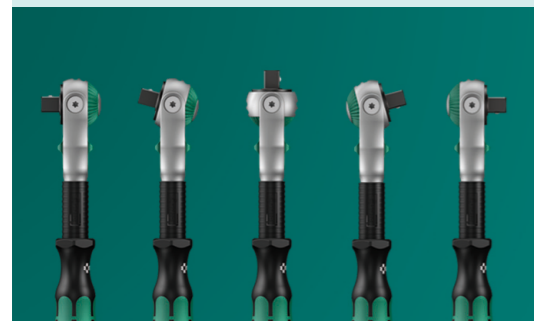

8794 C Zyklop wobble extension, 1/2"



Applications: For 1/2" square drive sockets
Design: Swivels through 15°; chrome vanadium, brushed chromium plating

Code		mm		
05003639001	1/2"	52,0		1

8784 C2 Zyklop adaptor, 1/2", 5/16"



Applications: Suitable for 1/2" hex bits under DIN 3126-C 8, ISO 1173, and Wera series 2
Design: With quick-release chuck for fast bit changes; chromium vanadium

Code			mm		
05003641001	5/16"	1/2"	50,0		1

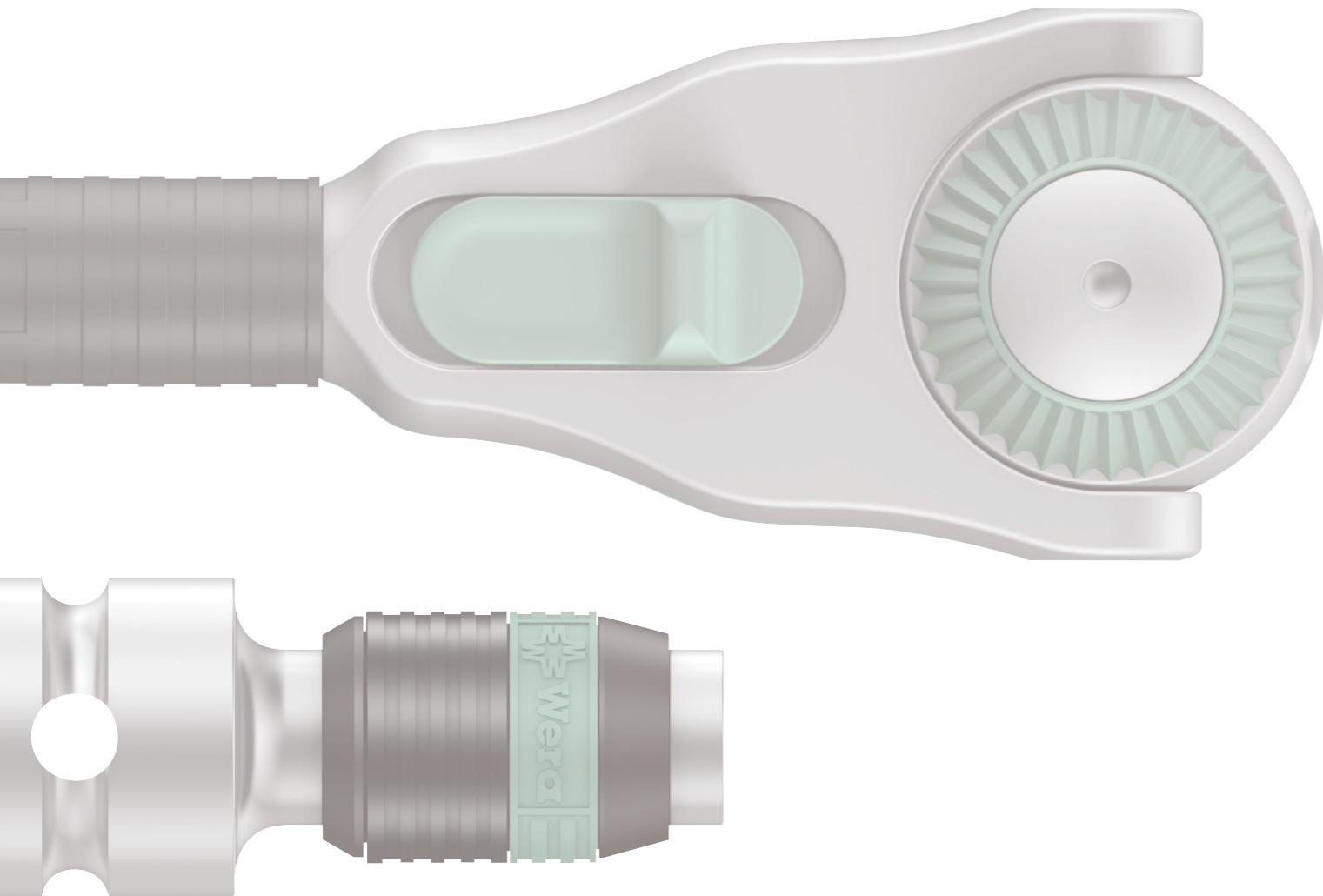

Display Zyklop, 1/4" drive



Applications: For 1/4" square sockets and accessories with square drive, with ball lock

Design: Rotating mass design and handy freewheel sleeve for faster work; swivelling ratchet head; 5 defined lock positions (at 0°, and at 15°, and 90° right and left); at 0° it can be used like a conventional screwdriver; pushbutton release; CW/ACW toggle, fine-pitched tooth design, with small return angle of 5° - 6°

Handle: Multicomponent Kraftform handle for comfort and torque

Code				
05003540001	8000 A	8 x 1/4"x152,0		1

Display Zyklop, 1/2" drive



Applications: For 1/2" square drive sockets and accessories

Design: Rotating mass design and handy freewheel sleeve for faster work; swivelling ratchet head; 5 defined lock positions (at 0°, and at 15°, and 90° right and left); at 0° it can be used like a conventional screwdriver; pushbutton release; CW/ACW toggle, fine-pitched tooth design, with small return angle of 5° - 6°

Handle: Multicomponent Kraftform handle for comfort and torque

Code				
05003650001	8000 C	5 x 1/2"x277,0		1

Display Zyklop, 3/8" drive



Applications: For 3/8" square drive sockets and accessories

Design: Rotating mass design and handy freewheel sleeve for faster work; swivelling ratchet head; 5 defined lock positions (at 0°, and at 15°, and 90° right and left); at 0° it can be used like a conventional screwdriver; pushbutton release; CW/ACW toggle, fine-pitched tooth design, with small return angle of 5° - 6°

Handle: Multicomponent Kraftform handle for comfort and torque

Code				
05003599001	8000 B	5 x 3/8"x199,0		1

X-ON Electronics

Largest Supplier of Electrical and Electronic Components

Click to view similar products for [wera](#) manufacturer:

Other Similar products are found below :

[05006120001](#) [05006154001](#) [05073670001](#) [05051021001](#) [05056702001](#) [05060053001](#) [05059291001](#) [05074750001](#) [3160 I/7](#) [8000 A](#) [7451](#)
[ESD 30,0 NCM](#) [7461](#) [816 RA](#) [KRAFTFORM KOMPAKT ZYKLOP 1/4"](#) [190I 3K SW 5,5 X 125 MM](#) [932/6](#) [367 TORX 7](#) [028122](#)
[05004350001](#) [05004352001](#) [167I 3K TX 45 X 150 MM](#) [05004650001](#) [05004660001](#) [05004670001](#) [05118062001](#) [05013334001](#)
[05074705001](#) [8100 SA4](#) [05004970001](#) [05024466001](#) [05024467001](#) [05003881001](#) [05003970001](#) [05003972001](#) [05003973001](#) [05075610001](#)
[05133285001](#) [05006451001](#) [05006461001](#) [05003431001](#) [05004203001](#) [05004202001](#) [05004201001](#) [05020091001](#) [05051016001](#) [8767](#) [8790](#)
[4.5](#) [8790 8.0](#) [8790 14.0](#) [8767 25 X 100MM](#)