

Protection components

Thermal relays, model LR2-D

to protect a.c. circuits and motors against overcurrent.

LRD-3322...4369, LR2-D

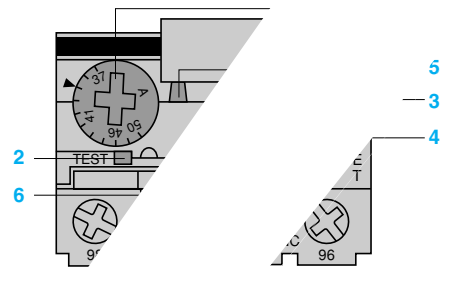

Not applicable for automatic operation.

Devices are supplied with the selector in the manual position, not in the automatic position.

Environment

Conforming to standards	EN 60947-1, EN 60947-4-1, NF C 63-650, VDE 0660
Product certifications	CSA, UL, Sichere Trennung, PTB except LAD-4: UL, CSA.
Degree of protection	Protection against direct finger contact IP 2X
Protective treatment	"TH"
Ambient air temperature around the device	Storage temperature: -60...+70 °C Normal operating temperature: -20...+60 °C Minimum operating temperature (with derating): -40...+70 °C
Operating positions without derating	Any position
Shock resistance	15 gn - 11 ms
Vibration resistance	6 gn
Dielectric strength at 50 Hz	6 kV
Impulse withstand voltage	6 kV

Auxiliary contact characteristics

Conventional thermal current	A	5						
Maximum consumption of operating coils of controlled contactors (Occasional operating cycles of contact 95-96)	a.c. supply	V	24	48	110	220	380	600
	d.c. supply	VA	100	200	400	600	600	600
			24	48	110	220	440	-
			100	100	50	45	25	-

Short-circuit protection: By gG or BS fuse. Max. rating or by GB2 circuit-breaker.

Connection to screw terminals	
Flexible cable without cable end	1 or 2 conductors
Flexible cable with cable end	1 or 2 conductors
Solid cable without cable end	1 or 2 conductors
Tightening torque	

Connection to spring terminals	
Flexible cable without cable end	1 or 2 conductors
Solid cable without cable end	1 or 2 conductors

References: pages 2/112 and 2/113 **Dimensions:** pages 2/116 to 2/118 **Schemes:** page 2/119

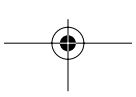
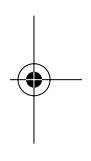
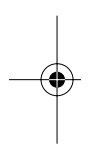

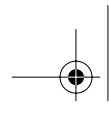

Characteristics

TeSys protection components

3-pole thermal overload relays, model d

Electrical characteristics of power circuit

Relay type			LRD-01 to 16	LR2-D15●●	LRD-21 to 35	LR2-D25●●	LRD-3322 to 33696	LR2-D35●●	LRD-4365 to 4369	
Tripping class	To UL 508, EN 60947-4-1		10 A	20	10 A	20	10 A	20	10 A	
Rated insulation voltage (U_i)	Conforming to EN 60947-4-1	V	690		690		1000		1000	
	Conforming to UL, CSA	V	600		600		600		600 except LRD-4369	
Rated impulse withstand voltage (U_{imp})		kV	6		6		6		6	
Frequency limits	Of the operational current	Hz	0...400		0...400		0...400		0...400	
Setting range	Depending on model	A	0.1...13		12...38		17...104		80...140	
Connection to screw clamp terminals	Flexible cable without cable end	1 conductor	mm²	Min/max c.s.a. 1.5/10		1.5/10		4/35		4/50
	Flexible cable with cable end	1 conductor	mm²	1/4		1/6 except LRD-21: 1/4		4/35		4/35
	Solid cable without cable end	1 conductor	mm²	1/6		1.5/10 except LRD-21: 1/6		4/35		4/50
	Tightening torque		N.m	1.7		1.85		2.5		9
Connection to spring terminals	Flexible cable without cable end	1 conductor	mm²	Min/max c.s.a. 1.5/4		-		-		-
	Solid cable without cable end	1 conductor	mm²	1.5/4		-		-		-

2

2.3

Operating characteristics

Temperature compensation		°C	-20...+60	-30...+60-	-30...+60	-20...+60
Tripping threshold	Conforming to EN 60947-4-1	A	1.14 ± 0.06 I _n			
Sensitivity to phase failure	Conforming to EN 60947-4-1		Tripping current 30 % of I _n on one phase, the others at I _n			

Average operating time related to multiples of the current setting

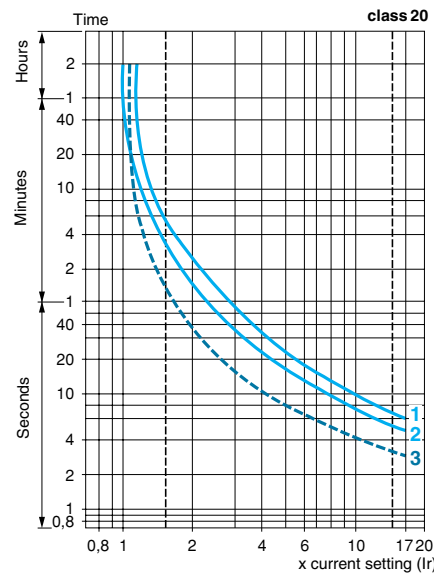
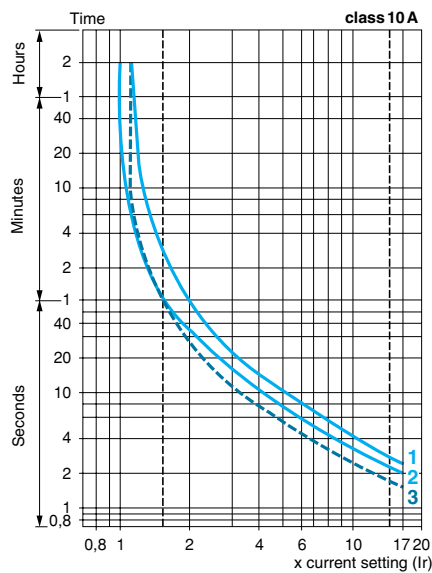

- 1 Balanced operation, 3-phase, from cold state.
- 2 Balanced operation, 2-phase, from cold state.
- 3 Balanced operation, 3-phase, after a long period at the set current (hot state).

References: pages 2/112 and 2/113

Dimensions: pages 2/116 to 2/118

Schemes: page 2/119

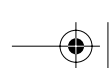

Description, characteristics

TeSys protection components

3-pole electronic thermal overload relays LR9-D

Description

LR9-D electronic thermal overload relays are designed for use with contactors LC1-D115 and D150.

In addition to the protection provided by model d thermal overload relays (see page 2/108) they offer the following special features:

- Protection against phase imbalance.
- Choice of starting class.
- Protection of unbalanced circuits.
- Protection of single-phase circuits.
- Alarm function to avoid tripping by load shedding.

2

- 1 Setting dial Ir
- 2 Test button
- 3 Stop button
- 4 Reset button
- 5 Trip indication
- 6 Setting locked by sealing the cover
- 7 Class 10/class 20 selector
- 8 Selector for balanced load / unbalanced load

LR9-D5367...D5569

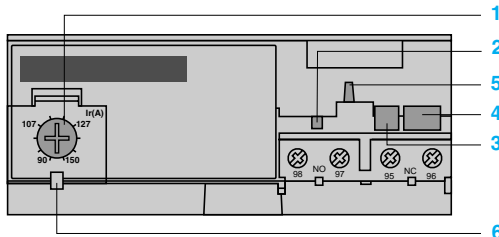

LR9-D67 and D69

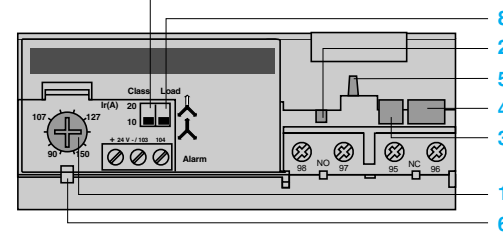

2.3

Environment

Conforming to standards			EN 60947-4-1, 255-8, 255-17, VDE 0660
Product certifications			UL 508 , CSA 22-2
Degree of protection	Conforming to IEC 529 and VDE 0106		IP 20 on front face with protective covers LA9-D11570● or D11560●
Protective treatment	Standard version		"TH"
Ambient air temperature around the device (conforming to IEC 255-8)	Storage	°C	- 40...+ 85
	Normal operation	°C	- 20...+ 55 (1)
Maximum operating altitude	Without derating	m	2000
Operating positions without derating	In relation to normal, vertical mounting plane		Any position
Shock resistance	Permissible acceleration conforming to IEC 68-2-27		13 gn - 11 ms
Vibration resistance	Permissible acceleration conforming to IEC 68-2-6		2 gn - 5 to 300 Hz
Dielectric strength at 50 Hz	Conforming to IEC 255-5	kV	6
Impulse withstand voltage	Conforming to IEC 1000-4-5	kV	6
Resistance to electrostatic discharge	Conforming to IEC 1000-4-2	kV	8
Resistance to radio-frequency conducted disturbances	Conforming to IEC 1000-4-3 and NF C 46-022	V/m	10
Resistance to fast transient currents	Conforming to IEC 1000-4-4	kV	2
Electromagnetic compatibility	Draft EN 50081-1 and 2, EN 50082-2		Meets requirements

Electrical characteristics of auxiliary contacts

Conventional thermal current		A	5
Maximum consumption of operating coils of controlled contactors (Occasional operating cycles of contact 95-96)	a.c. supply	V	24 48 110 220 380 600
		VA	100 200 400 600 600 600
Short-circuit protection	d.c. supply	V	24 48 110 220 440 -
		W	100 100 50 45 25 -
Cabling Flexible cable without cable end	1 or 2 conductors	mm ²	Minimum c.s.a.: 1/maximum c.s.a.: 2.5
	Tightening torque	N.m	1.2

(1) For operation at 70 °C, please call our Customer information centre on 0870 608 8 608.

References:
pages 2/112 and 2/113

Dimensions:
pages 2/116 to 2/118

Schemes:
page 2/119

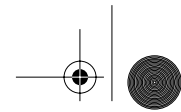

Characteristics

TeSys protection components

3-pole electronic thermal overload relays LR9-D

Electrical characteristics of power circuit

Relay type			LR9-D
Tripping class	Conforming to UL 508, EN 60947-4-1		10 A or 20
Rated insulation voltage (Ui)	Conforming to EN 60947-4-1	V	1000
	Conforming to UL, CSA	V	600
Rated impulse withstand voltage (Uimp)		kV	8
Frequency limits	Of the operational current	Hz	50...60. For other frequencies, call our Customer information centre on 0870 608 8 608 (1)
Setting range	Depending on model	A	60...150
Power circuit connections	Width of terminal lug	mm	20
	Clamping screw		M8
	Tightening torque	N.m	18

2

Operating characteristics

Temperature compensation		°C	- 20...+ 70
Tripping thresholds	To EN 60947-4-1 Alarm	A	$1.05 \pm 0.06 I_n$
	Tripping	A	$1.12 \pm 0.06 I_n$
Sensitivity to phase failure	Conforming to EN 60947-4-1		Tripping in $4 \text{ s} \pm 20\%$ in the event of phase failure

2.3

Alarm circuit characteristics

Rated supply voltage	d.c. supply	V	24
Supply voltage limits		V	17...32
Current consumption	No load	mA	≤ 5
Switching capacity		mA	0...150
Protection	Short-circuit and overload		Self-protected
Voltage drop	Closed state	V	≤ 2.5
Cabling	Flexible cable without cable end	mm²	0.5...1.5
Tightening torque		N.m	0.45

Tripping curve LR9-D

Average operating time related to multiples of the current setting

Tripping time in seconds

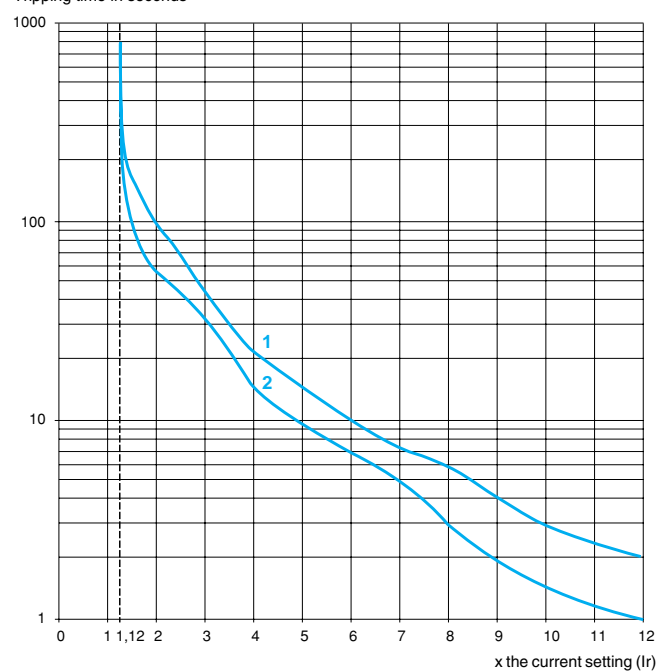
1 Cold state curve
2 Hot state curve

(1) For use of these relays with soft start units or variable speed controllers, please call our Customer information centre on 0870 608 8 608.

References:
pages 2/112 and 2/113Dimensions:
pages 2/116 to 2/118Schemes:
page 2/119

Schneider Electric

Telemecanique

2/111





References

TeSys protection components

3-pole thermal overload relays, model d

Differential thermal overload relays for use with fuses. Class 10 A tripping

- Compensated relays with manual or automatic reset,
- with relay trip indicator,
- for a.c. or d.c.

Relay setting range A	Fuses to be used with selected relay			For use with contactor LC1-	Reference	Weight kg
	aM	gG	BS88			

Class 10 A (1) with connection by screw clamp terminals

0.10...0.16	0.25	2	–	D09...D38	LRD-01	0.124
0.16...0.25	0.5	2	–	D09...D38	LRD-02	0.124
0.25...0.40	1	2	–	D09...D38	LRD-03	0.124
0.40...0.63	1	2	–	D09...D38	LRD-04	0.124
0.63...1	2	4	–	D09...D38	LRD-05	0.124
1...1.7	2	4	6	D09...D38	LRD-06	0.124
1.6...2.5	4	6	10	D09...D38	LRD-07	0.124
2.5...4	6	10	16	D09...D38	LRD-08	0.124
4...6	8	16	16	D09...D38	LRD-10	0.124
5.5...8	12	20	20	D09...D38	LRD-12	0.124
7...10	12	20	20	D09...D38	LRD-14	0.124
9...13	16	25	25	D12...D38	LRD-16	0.124
12...18	20	35	32	D18...D38	LRD-21	0.124
16...24	25	50	50	D25...D38	LRD-22	0.124
23...32	40	63	63	D25...D38	LRD-32	0.124
30...38	50	80	80	D32 and D38	LRD-35	0.124
17...25	25	50	50	D40...D95	LRD-3322	0.510
23...32	40	63	63	D40...D95	LRD-3353	0.510
30...40	40	100	80	D40...D95	LRD-3355	0.510
37...50	63	100	100	D40...D95	LRD-3357	0.510
48...65	63	100	100	D50...D95	LRD-3359	0.510
55...70	80	125	125	D50...D95	LRD-3361	0.510
63...80	80	125	125	D65 and D95	LRD-3363	0.510
80...104	100	160	160	D80 and D95	LRD-3365	0.510
80...104	125	200	160	D115 and D150	LRD-4365	0.900
95...120	125	200	200	D115 and D150	LRD-4367	0.900
110...140	160	250	200	D150	LRD-4369	0.900
80...104	100	160	160	(2)	LRD-33656	1.000
95...120	125	200	200	(2)	LRD-33676	1.000
110...140	160	250	200	(2)	LRD-33696	1.000

Class 10 A (1) with spring terminal connections (for direct mounting on the contactor only)

0.10...0.16	0.25	2	–	D09...D38	LRD-013	0.140
0.16...0.25	0.5	2	–	D09...D38	LRD-023	0.140
0.25...0.40	1	2	–	D09...D38	LRD-033	0.140
0.40...0.63	1	2	–	D09...D38	LRD-043	0.140
0.63...1	2	4	–	D09...D38	LRD-053	0.140
1...1.6	2	4	6	D09...D38	LRD-063	0.140
1.6...2.5	4	6	10	D09...D38	LRD-073	0.140
2.5...4	6	10	16	D09...D38	LRD-083	0.140
4...6	8	16	16	D09...D38	LRD-103	0.140
5.5...8	12	20	20	D09...D38	LRD-123	0.140
7...10	12	20	20	D09...D38	LRD-143	0.140
9...13	16	25	25	D12...D38	LRD-163	0.140
12...18	20	35	32	D18...D38	LRD-213	0.140
16...24	25	50	50	D25...D38	LRD-223	0.140

Class 10 A (1) with connection by lug-clamps

Select the appropriate overload relay with screw clamp terminals from the table above and add 6 to the end of the reference. Example: LRD-01 becomes LRD-016.

Thermal overload relays for use with unbalanced loads

Class 10 A (1) with connection by screw clamp terminals

Change the prefix in the references above from LRD (except LRD-4●●●) to LR3-D. Example: LRD-01 becomes LR3-D01.

Thermal overload relays for use on 1000 V supplies

Class 10 A (1) with connection by screw clamp terminals

For relays LRD-01 to LRD-35 only, for an operating voltage of 1000 V, and only for independent mounting, the reference becomes LRD-33●●A66. Example: LRD-12 becomes LRD-3312A66.

Order an LA7-D3064 terminal block separately, see page 2/115.

(1) Standard IEC 947-4-1 specifies a tripping time for 7.2 times the setting current I_n :

class 10 A: between 2 and 10 seconds.

(2) Independent mounting.

Characteristics:
pages 2/108 to 2/111

Dimensions:
pages 2/116 to 2/118

Schemes:
page 2/119

2/112

Telemecanique

Schneider Electric

2



LRD-08



LRD-21

2.3

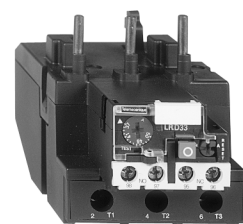

LRD-33●●



LRD-083

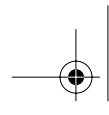

References

TeSys protection components

3-pole thermal overload relays, model d

Differential thermal overload relays for use with fuses. Class 20 tripping

- Compensated relays with manual or automatic reset,
- with relay trip indicator,
- for a.c. or d.c.
- LR2-D1508 to 2553: independent mounting
 - either by ordering a terminal block **LA7-D1064** or **LA7-D2064**, see page 2/115,
 - or by ordering the the relay pre-assembled; in this case add the suffix **LA7** to the reference.

Example: **LR2-D1508** becomes **LR2-D1508LA7**.

Relay setting range	Fuses to be used with the selected relay			For use with contactor LC1	Reference	Weight kg
	aM	gG	BS88			
A	A	A	A			

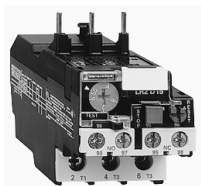

LR2-D1508

Class 20 (1) for connection by screw clamp terminals

Relay setting range	Fuses to be used with the selected relay	For direct mounting beneath contactor LC1	Reference	Weight kg
2.5...4	6 10 16	D09...D32	LR2-D1508	0.190
4...6	8 16 16	D09...D32	LR2-D1510	0.190
5.5...8	12 20 20	D09...D32	LR2-D1512	0.190
7...10	16 20 25	D09...D32	LR2-D1514	0.190
9...13	16 25 25	D12...D32	LR2-D1516	0.190
12...18	25 35 40	D18...D32	LR2-D1521	0.190
17...25	32 50 50	D25 and D32	LR2-D1522	0.190
23...32	40 63 63	D25 and D32	LR2-D2553	0.345
17...25	32 50 50	D40...D95	LR2-D3522	0.535
23...32	40 63 63	D40...D95	LR2-D3553	0.535
30...40	50 100 80	D40...D95	LR2-D3555	0.535
37...50	63 100 100	D50...D95	LR2-D3557	0.535
48...65	80 125 100	D50...D95	LR2-D3559	0.535
55...70	100 125 125	D65...D95	LR2-D3561	0.535
63...80	100 160 125	D80 and D95	LR2-D3563	0.535

Electronic differential thermal overload relays for use with fuses. Class 10 A or 20

- Compensated relays,
- with relay trip indicator,
- for a.c. or d.c.,
- for direct mounting on contactor or independent mounting (2).

Relay setting range	Fuses to be used with selected relay	For direct mounting beneath contactor LC1	Reference	Weight kg
A	A	A		

Class 10 or 10A (1) with connection using bars or connectors

Relay setting range	Fuses to be used with selected relay	For direct mounting beneath contactor LC1	Reference	Weight kg
60...100	100 160	D115 and D150	LR9-D5367	0.885
90...150	160 250	D115 and D150	LR9-D5369	0.885

Class 20 (3) with connection using bars or connectors

Relay setting range	Fuses to be used with selected relay	For direct mounting beneath contactor LC1	Reference	Weight kg
60...100	125 160	D115 and D150	LR9-D5567	0.885
90...150	200 250	D115 and D150	LR9-D5569	0.885

Electronic thermal overload relays for use with balanced or unbalanced loads

- Compensated relays,
- with separate outputs for alarm and tripping.

Relay setting range	Fuses to be used with the selected relay	For direct mounting beneath contactor LC1	Reference	Weight kg
A	A	A		

Class 10 A or 20 (1) selectable with connection using bars or connectors

Relay setting range	Fuses to be used with selected relay	For direct mounting beneath contactor LC1	Reference	Weight kg
60...100	100 160	D115 and D150	LR9-D67	0.900
90...150	160 250	D115 and D150	LR9-D69	0.900

(1) Standard IEC 947-4-1 specifies a tripping time for 7.2 times the setting current I_n

class 10: between 4 and 10 seconds,

class 10 A: between 2 and 10 seconds,

class 20: between 6 and 20 seconds.

(2) Power terminals can be protected against direct finger contact by the addition of shrouds and/or insulated terminal blocks, to be ordered separately (see page 2/90).

Other versions

Thermal overload relays for resistive circuits in category AC-1.
Please call our Customer information centre on 0870 608 8 608.

Characteristics:
pages 2/108 to 2/111

Dimensions:
pages 2/116 to 2/118

Schemes:
page 2/119

Schneider Electric

Telemecanique

2/113

2

2.3

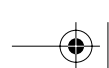
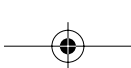

2

2.3

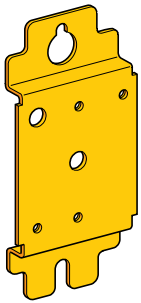

DX1-AP26



2

2.3

Dimensions

TeSys protection components

Model d thermal overload relays

2

LRD-01...35
Direct mounting beneath contactors with screw clamp connections

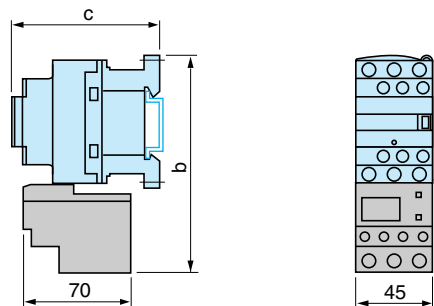

LRD-013...353
Direct mounting beneath contactors with spring terminal connections

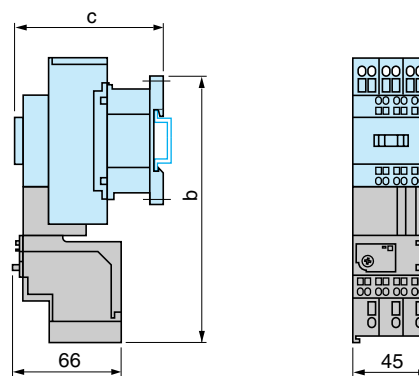

LC1-	D09...D18	D25...D38
b	123	137
c	see pages 2/94 and 2/95	

LC1-	D093...D383
b	168
c	see pages 2/94 and 2/95

2.3

LRD-3●●●
Direct mounting beneath contactors
LC1-D40 to D95 and LP1-D40 to D80

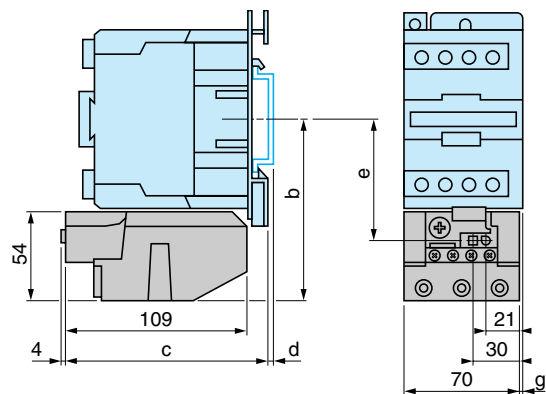

AM1-	DL201	DL200			
d	7	17			
			b	c	e g (3P) g (4P)
Control circuit: a.c.					
LC1-D40			111	119	72.4 4.5 13
LC1-D50			111	119	72.4 4.5 -
LC1-D65			111	119	72.4 4.5 13
LC1-D80			115.5	124	76.9 9.5 22
LC1-D95			115.5	124	76.9 9.5 -
Control circuit: d.c.					
LC1-D40, LP1-D40			111	176	72.4 4.5 13
LC1-D50			111	176	72.4 4.5 -
LC1-D65, LP1-D65			111	176	72.4 4.5 13
LC1-D80, D95, LP1-D80			115.5	179.4	76.9 9.5 22

LRD-4●●●
Direct mounting beneath contactors
LC1-D115 and D150

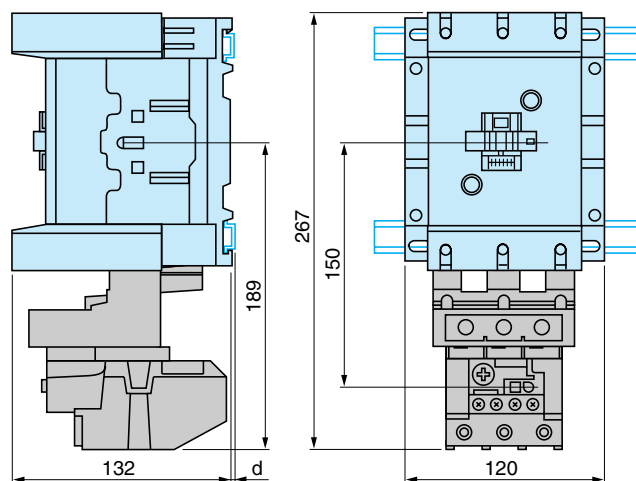

AM1-DL200 and DR200	AM1-DE200 and ED●●●
d	2.5 10.5

LR9-D
Direct mounting beneath contactors
LC1-D115 and D150

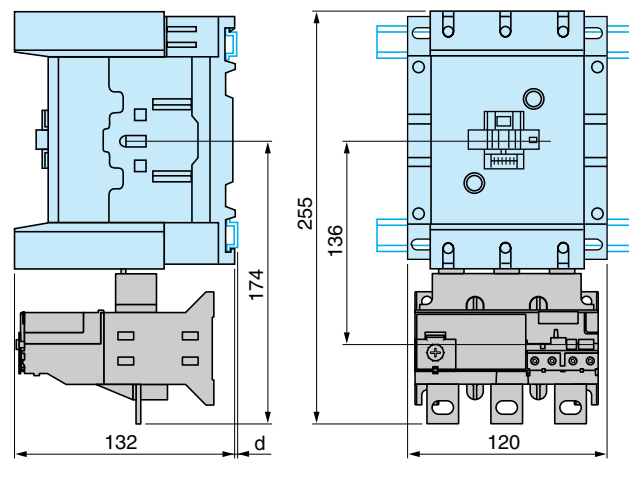

AM1-DP200 and DR200	AM1-DE200 and ED●●●
d	2.5 10.5

Characteristics: pages 2/108 to 2/111
References: pages 2/112 and 2/113
Schemes: page 2/119

LRD-01...35
 Independent mounting on 50 mm centres
 or on rail AM1-DP200 or DE200

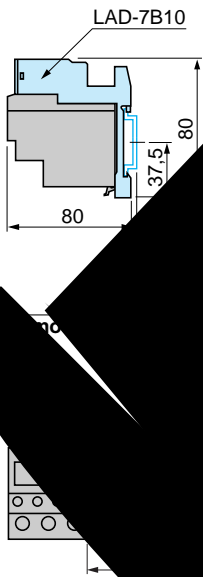

(1) Can only be mounted on rail
LR2-D15
 Independent mounting on 50 mm centres
 or on rail AM1-DP200 or DE200

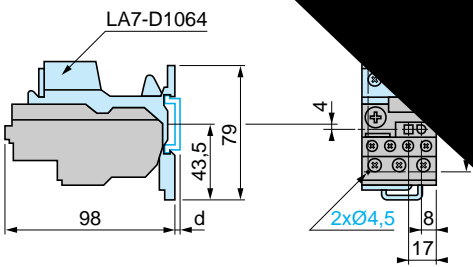

	AM1-DP200	AM1-DE200
d	2	9.5

LR2-D20
 Independent mounting on 50 mm centres
 or on rail AM1-DP200 or DE200

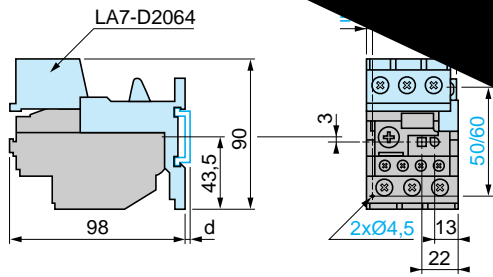

	AM1-DP200	AM1-DE200
d	2	9.5

(1) Can be mounted on RH or LH side of rail

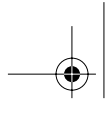

Mounting (continued)

TeSys protection components
Model d thermal overload relays

2

LRD-3●●● and LR2-D35●●
Independent mounting on 50 mm centres
or on mounting rail AM1-DP200 or DE200

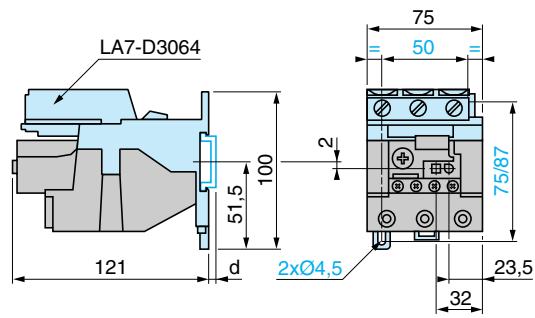

LRD-3●●●, LR2-D35●● and LR9-D
Remote tripping or electrical reset

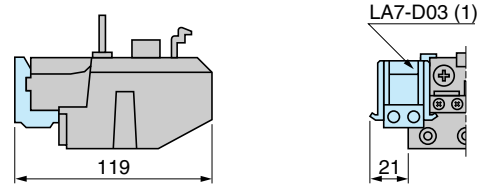

	AM1-DP200	AM1-DE200
d	2	9.5

(1) Can be mounted on RH or LH side of relays LRD-3●●●, LR2-D35●● or LR9-D

2.3

LR2-D and LRD-3●●●
Adapter for door interlock mechanism
LA7-D1020

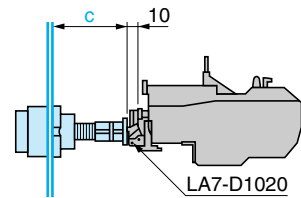

Stop

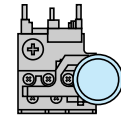

Reset

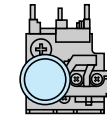

c: adjustable from 17 to 120 mm

LRD, LR2-D and LR9-D
"Reset" by flexible cable
LA7-D305 and LAD-7305
Mounting with cable straight

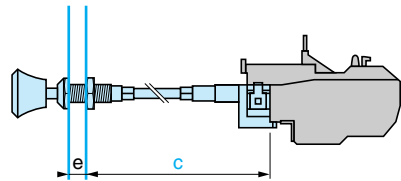

Mounting with cable bent

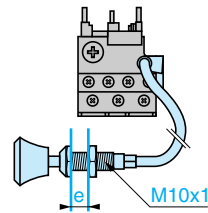

c: up to 550 mm
e: up to 20 mm

e: up to 20 mm

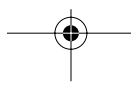

Schemes

TeSys protection components

Model d thermal overload relays

LRD, LR2-D and LR3-D

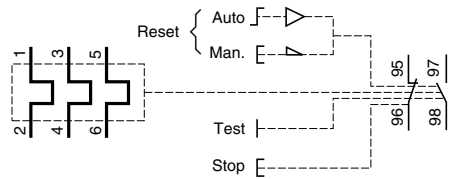

Pre-cabing kit
LAD-7C1, LAD-7C2

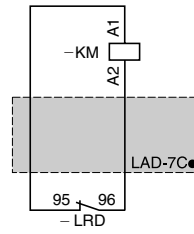

2

LR9-D5●●●

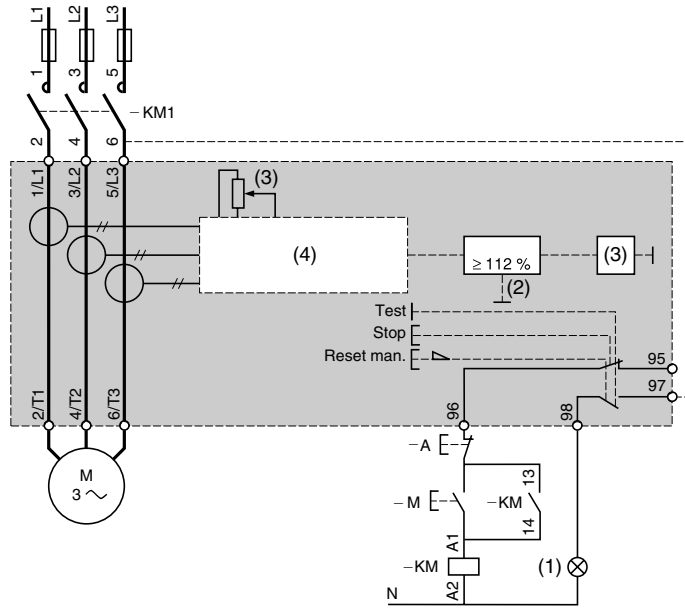

- (1) Tripped
- (2) Overload
- (3) Setting current
- (4) Specialised circuit

2.3

LR9-D67 and LR9-D69

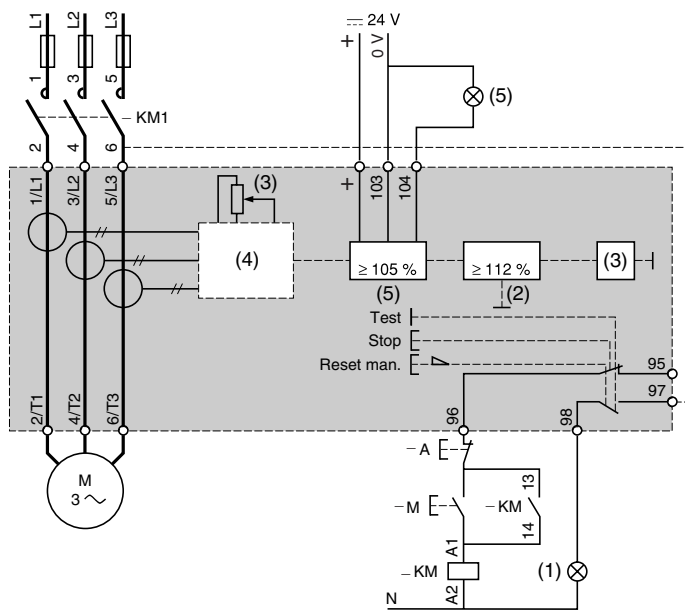

- (1) Tripped
- (2) Overload
- (3) Setting current
- (4) Specialised circuit
- (5) Alarm

Characteristics:
pages 2/108 to 2/111

References:
pages 2/112 and 2/113

Dimensions:
pages 2/116 to 2/118

X-ON Electronics

Authorized Distributor

Click to view similar products for [Schneider manufacturer](#).

Other Similar products are found below :

[VCF5GEN](#) [VCF6GEN](#) [LU9MR1](#) [LUCB18BL](#) [8501RS14V20](#) [8501RS44V24](#) [8501RSD14P14V51](#) [8501RSD42V53](#)

[8501XO20V03Y414](#) [8501XO40V02](#) [9001K51](#) [9001KR1BH5](#) [9001KR9R05](#) [9001KS11BH2](#) [9001KXRK](#) [9001SKR9P35RH25](#)

[9001SKT35L31](#) [9003K2C003GA](#) [9007AA1](#) [9007C54D](#) [9007C54J](#) [9007C62A2](#) [9007C68T5](#) [9007HA4](#) [9007MS01S0206](#)