



The plastic circular connector with metal locking

UTG provides the complete answer to the need for economical lightweight and robust metal coupling



Flammability rating ■ UL94-V0 compliant

Rapid and secure locking ■ Locks with audible positive «click»

Intermateable and interchangeable ■ With UTO, UTP and UTS series

Complete range of contacts ■ Trim Trio contacts #16

Layout

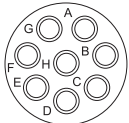
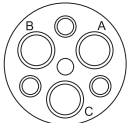
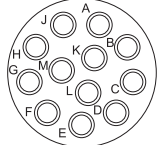
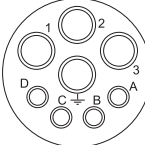
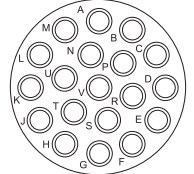
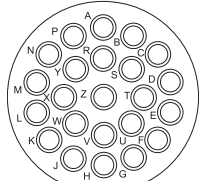
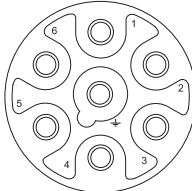
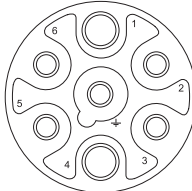
Shell size	Contact # 16 (Ø 1,6)	Mixed power / signal versions	
10	 <p>10-4 4 x #16 (Ø 1,6)</p>	 <p>10-3 3 x #16 (Ø 1,6) Group C 250V</p>	 <p>10-3W3 3 x #16 (Ø 1,6) 3 x #20 (Ø 1,0)</p>
12	 <p>12-8 8 x #16 (Ø 1,6)</p>	 <p>122G1 3 x #12 (Ø 2,4)</p>	
14	 <p>14-12 12 x #16 (Ø 1,6)</p>	 <p>14-8 4 x #12 (Ø 2,4) 4 x #16 (Ø 1,6)</p>	
16	 <p>16-19 19 x #16 (Ø 1,6)</p>		
18	 <p>18-23 23 x #16 (Ø 1,6)</p>	 <p>18-7 Group C 380V 7 x #16 (Ø 1,6)</p>	 <p>18-7 34 2 x #12 (Ø 2,4) 5 x #16 (Ø 1,6)</p>

UTG Series

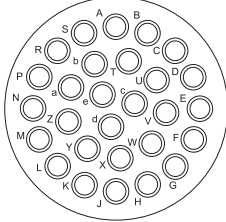
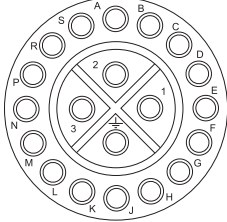
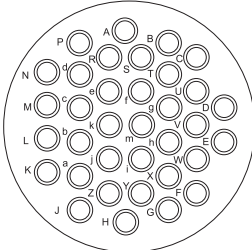
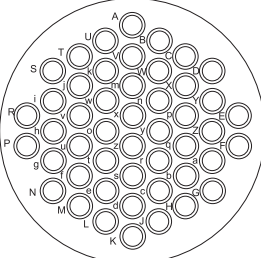
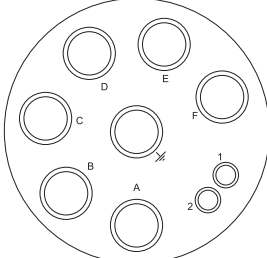
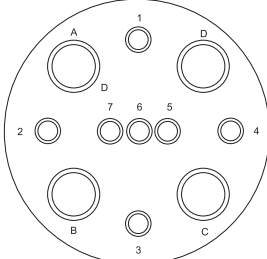
Shell size	Contact # 16 (Ø 1,6)	Mixed power / signal versions
20	 <p data-bbox="537 663 711 722">20-28 28 x #16 (Ø 1,6)</p>	 <p data-bbox="1138 663 1312 751">20-20 20 x #16 (Ø 1,6) Group C 660V</p>
22	 <p data-bbox="537 1062 711 1121">22-35 35 x #16 (Ø 1,6)</p>	
24	 <p data-bbox="537 1451 711 1509">24-48 48 x #16 (Ø 1,6)</p>	 <p data-bbox="1138 1451 1312 1539">24-7 7 x #8 (Ø 3,6) 2 x #16 (Ø 1,6)</p>
		 <p data-bbox="1138 1839 1312 1927">24-11 4 x #8 (Ø 3,6) 7 x #16 (Ø 1,6)</p>

Contact identification positions shown are for mating face of pin contact connectors and wire face of socket contact connectors.



Specifications

Shell size	Contacts number*	Connector type / Part number			
		Cable plug		Panel mounting receptacle	
		Male insert	Female insert	Male insert	Female insert
10	4 #16	UTG6104PN	UTG6104SN	UTG0104P	UTG0104S
	2 + ground #16	UTG6103PN	UTG6103SN	UTG0103P	UTG0103S
	3 #20 + 3 #16	UTG6103W3PN	-	-	-
12	8 #16	UTG6128PN	UTG6128SN	UTG0128P	UTG0128S
	3 #12	UTG6122G1PN	UTG6122G1SN	UTG0122G1P	UTG0122G1S
14	12 #16	UTG61412PN	UTG61412SN	UTG01412P	UTG01412S
	4#12 + 4 #16	-	UTG6148SN	UTG0148P	-
16	19 #16	UTG61619PN	UTG61619SN	UTG01619P	UTG01619S
18	23 #16	UTG61823PN	UTG61823SN	UTG01823P	UTG01823S
	7 #16	UTG6187PN	UTG6187SN	UTG0187P	UTG0187S
	2 #12 + 5 #16	UTG6187PN34	UTG6187SN34	UTG0187P34	UTG0187S34
20	28 #16	UTG62028PN	UTG62028SN	UTG02028P	UTG02028S
	20 #16	UTG62020PN	UTG62020SN	UTG02020P	UTG02020S
22	35 #16	UTG62235PN	UTG62235SN	UTG02235P	UTG02235S
24	48 #16	UTG62448PN	UTG62448SN	UTG02448P	UTG02448S
	7 #8 + 2 #16	UTG6247PN	UTG6247SN	UTG0247P	UTG0247S
	4 #8 + 7 #16	-	UTG62411SN	UTG02411P	-

*Contacts supply separately

For IP65 waterprotected version (for only receptacle) add «H» behind N or S. Ex. UTG0103PH

Dimensions

Cable Plug - UTG6

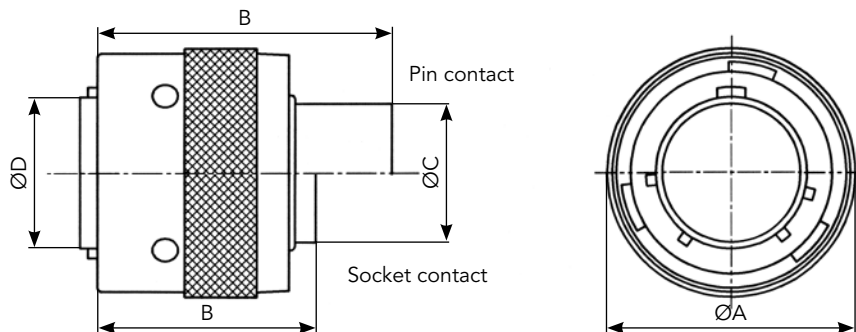

Shell size	ØA ^{±0.2}	B max		ØC ^{±0.15}	ØD ^{±0.15}	ØE ^{±0.2}
		Pin contact	Socket contact			
10	21.6	31.8	23.9 / 26.75	10.9	12.2	19.1
12	24.8		23.9	13.8	15.1	
14	28.0			17.0	18.3	
16	31.2		19.9	21.5		
18	34.3	31.8 / 33.0	23.9 / 29.0	22.4	24.0	
20	37.5	31.8 / 35.3	24.9	25.6	27.2	
22	47.0	31.8		28.5	30.4	
24	50.1		26.2	31.7	33.5	

Wall Mounting - UTG0

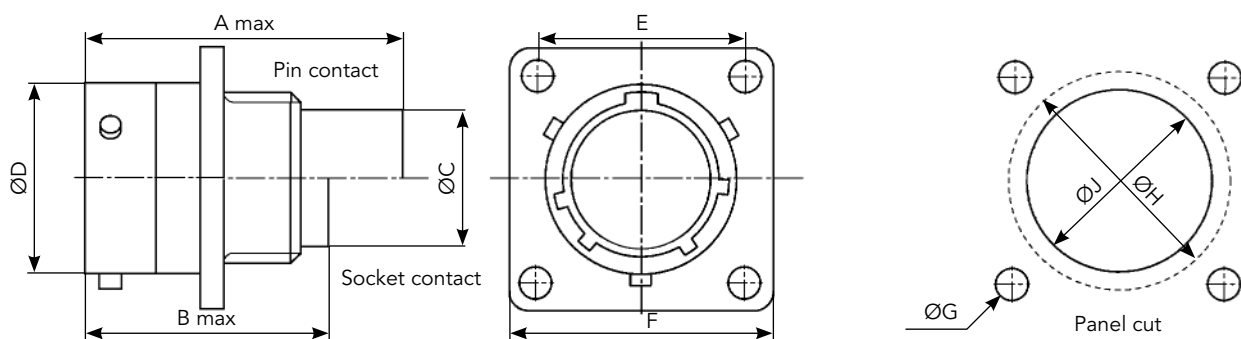

Shell size	A max		B ^{±0.15}	C ^{±0.2}	ØD ^{±0.15}	ØE ^{±0.2}	F ^{±0.25}	ØG ^{±0.1}	ØH ^{±0.1}	ØJ ^{±0.1}
	Pin contact	Socket contact								
10	31.7	24.3 / 27.6	2.3	11.3	15.0	18.3	23.8	3.2	17.3	15.1
12		24.3			19.0	20.6	26.2		21.8	18.2
14					22.2	23.0	28.6		25.0	21.4
16		25.3			24.6	31.0	28.1		24.6	
18	31.7 / 34.0	24.3 / 30.4	2.5	11.3 / 17.9	28.5	27.0	33.3		31.3	27.7
20	33.3	27.0		14.5	31.7	29.4	36.5		34.5	30.9
22		28.0	34.9		31.8	39.7	37.7		34.1	
24		30.4	3.5	15.3	38.0	34.9	42.9		3.9	40.9

Note: all dimensions are in mm



Specifications

Shell size	Contacts number*	Connector type / Part number	
		Free hanging receptacle	
		Male insert	Female insert
10	4 #16	UTG1104P	UTG1104S
	2 + ground #16	UTG1103P	UTG1103S
	3 #20 + 3 #16	-	UTG1103W3S
12	8 #16	UTG1128P	UTG1128S
14	12 #16	UTG11412P	UTG11412S
16	19 #16	UTG11619P	UTG11619S
18	23 #16	UTG11823P	UTG11823S
20	28 #16	UTG12028P	UTG12028S
22	35 #16	UTG12235P	UTG12235S
24	48 #16	UTG12448P	UTG12448S
	7 #8 + 2 #16	UTG1247P	UTG1247S

*Contacts supply separately
 For IP65 waterprotected version (for only receptacle) add «H» behind N or S. Ex. UTG1103PH

Dimensions

Free Hanging - UTG1

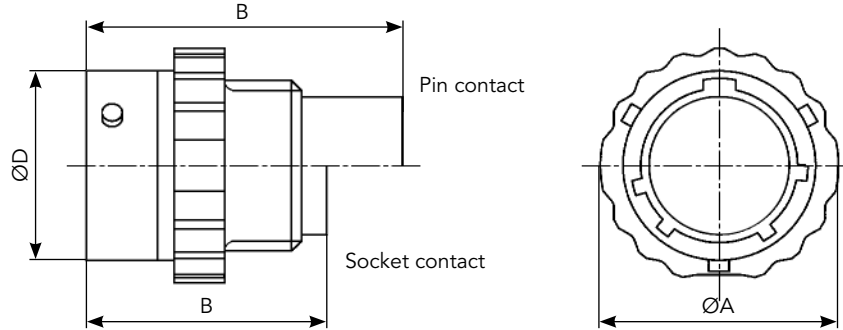

Shell size	$\text{ØA}^{\pm 0.2}$	B max		$\text{ØD}^{\pm 0.15}$
		Pin contact	Socket contact	
10	19.5	31.7	24.3 / 27.6	15.0
12	23.5		24.3	19.0
14	27			22.2
16	30.0		25.3	
18	33.3	31.7 / 34.0	24.3 / 30.4	28.5
20	36.5	33.3 / 34.3	25.9	31.7
22	39.5	38.0		34.9
24	42.1			38.0

Accessories

Cable Clamp



Part number	Shell size
UTG10AC	10
UTG12AC	12
UTG14AC	14
UTG16AC	16
UTG18AC	18
UTG20AC	20
UTG22AC	22
UTG24AC	24

Cable Clamp for Waterprotected (IP65) Applications



Part number	Shell size
UTG10PG	10
UTG12PG	12
UTG14PG	14
UTG16PG	16
UTG18PG	18
UTG20PG	20
UTG22PG	22
UTG24PG	24

Cable Gland for Waterprotected (IP65) Applications



Part number	Shell size
UTG10ST	10
UTG12ST	12
UTG14ST	14
UTG16ST	16
UTG18ST	18
UTG20ST	20
UTG22ST	22
UTG24ST	24

Metal Shrink Boot



Part number	Shell size
UTG10AD	10
UTG12AD	12
UTG14AD	14
UTG16AD	16
UTG18AD	18
UTG20AD	20
UTG22AD	22
UTG24AD	24

Dustcap (Receptacle)



Part number	Shell size
UTP10DC	10
UTP12DC	12
UTP14DC	14
UTP16DC	16
UTP18DC	18
UTP20DC	20
UTP22DC	22
UTP24DC	24

Dustcap with Chain (Receptacle)



Part number	Shell size
UTP10DCG	10
UTP12DCG	12
UTP14DCG	14
UTP16DCG	16
UTP18DCG	18
UTP20DCG	20
UTP22DCG	22
UTP24DCG	24

Plastic Protective Cap for Receptacle



Part number	Shell size
8500-5586A	10
8500-5587A	12
8500-5588A	14
8500-5589A	16
8500-5590A	18
8500-5591A	20
8500-5592A	22
8500-5593A	24

Gasket



Part number	Shell size
UTFD12B	10
UTFD13B	12
UTFD14B	14
UTFD15B	16
UTFD16B	18
UTFD17B	20
UTFD18B	22
UTFD19B	24

Contact Selector Guide

Contact supplied separately

Electrical characteristics: contact resistance		
#20 Ø1mm	Machined	< 6mΩ
	Stamped & Formed	< 6mΩ
#16 Ø1.6mm	Machined	< 3mΩ
	Stamped & Formed	< 6mΩ
#12 Ø2.4mm	Machined	< 5mΩ
#8 Ø3.6mm	Machined	< 5mΩ

Available platings (contact supplied separately)	
A	2μ Ni + 2μ Ag
J	Gold flash over 2μ Ni
K	Min 0.4μ gold over 2μ Ni
S31	Active part: Gold flash over Ni Crimp area: Nickel
S18	Active part: 0.75μ gold min over 2μ Ni Crimp area: 1.3μ tin over Ni Other: Nickel
S25 S26	Active part: 0.75μ Au over Ni Crimp area: flash Au over Ni
TK6	2-5μ Sn pre-plated
D70	Superseded by S31
S6	Superseded by S18
Other platings on request (contact supplied separately)	
T	T: 2μ Ni mini all over + 3 to 5 μm Sn all over
D28	0.75μ gold over Ni

Packaging

Due to the wide variety of applications, contact packaging is offered for small series (bulk package) and high volume production (reeled contacts):

Size contacts #20 (Ø1mm) & #16 (Ø1.6mm)



- 25 pieces loose package (Stamped & Formed contacts)



- 50 pieces bulk package (Machined contacts)



- 1,000 pieces bulk package (Machined contacts)

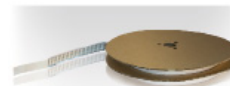

- 3,000 pieces reeled (Stamped & Formed contacts)

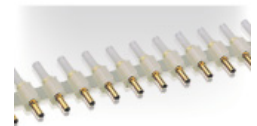

- 2,000 pieces reeled (Machined contacts)

Size contacts #12 (Ø2.4mm) & #8 (Ø3.6mm)



- 100 pieces bulk package (Machined contacts)

Note: 1,000 pieces bulk package available by adding 1000 at the end of the part number: e.g. RC16M23K1000
2,000 pieces reeled package available by adding K at the beginning of the part number: e.g. KRC16M23K

Crimp Contacts

Standard Version



Contact size	Type	Wire size		Part number		Max wire Ø	Max insulator Ø	Available plating	
		AWG	mm ²	Male	Female				
#20 Ø1 mm	Machined	26-24	0.13-0.20	RM24W3K	RC24W3K	-	1.58 max	K	
	Stamped & Formed	26-24	0.13-0.25	SM24W3 - (1)	SC24W3 - (1)	-	0.89-1.58	TK6 S25 (female) S26 (male)	
				SM24WL3 - (2)	SC24WL3 - (2)	-			
	Machined	22-20	0.32-0.52	0.35-0.5	RM20W3K	RC20W3K	-	1.58 max	K
					SM20W3 - (1)	SC20W3 - (1)	-		
Stamped & Formed	22-20	0.35-0.5	SM20WL3 - (2)	SC20WL3 - (2)	-	1.17-2.08	TK6 S25 (female) S26 (male)		
Machined	20-18	0.50-0.93		RM18W3K	RC18W3K		2.10 max	K	
#16 Ø1.6 mm	Machined	30-28	0.05-0.08	RM28M1-	RC28M1-	0.55	1.1	K, J	
	Machined	26-24	0.13-0.2	RM24M9-	RC24M9-	0.8	1.6	K, J	
	Stamped & Formed	26-24	0.13-0.25	SM24M1 - (1)	SC24M1 - (1)	0.89-1.28	Insulation grip	S31, S18, TK6	
				SM24ML1 - (2)	SC24ML1 - (2)				
	Machined	22-20	0.32-0.52	RM20M13-	RC20M13-	1.18	1.8	K, J	
				RM20M12-	RC20M12-		2.2		
	Stamped & Formed	22-20	0.35-0.5	SM20M1 - (1)	SC20M1 - (1)	1.17-2.08	Insulation grip	S31, S18, TK6	
				SM20ML1 - (2)	SC20ML1 - (2)				
	Machined	20-16	0.52-1.5	RM16M23-	RC16M23-	1.8	3.2	K, J	
	Stamped & Formed	18-16	0.8-1.5	SM16M1 - (1)	SC16M1 - (1)	3.0	No insulation grip	S31, S18, TK6	
SM16ML1 - (2)				SC16ML1 - (2)					
Stamped & Formed	18-16	0.8-1.5	SM16M11 - (1)	SC16M11 - (1)	2.0-3.0	Insulation grip	S31, S18, TK6		
			SM16ML11 - (2)	SC16ML11 - (2)					
Machined	16-14	1.5-2.5	RM14M30-	RC14M30-	2.28	3.2	K, J		
Stamped & Formed	14	2.0-2.5	SM14M1 - (1)	SC14M1 - (1)	3.2	No insulation grip	S31, S18, TK6		
			SM14ML1 - (2)	SC14ML1 - (2)					
#12 Ø2.4 mm	Machined	22	0.13-0.4	82911457N-	82911456-	-	4.9	A, K	
		20	0.5	82911459N-	82911458-				
		18	0.75-1.0	82911461N-	82911460-				
		16	1.5	82911463N-	82911462-				
		14	2.5	82911465N-	82911464-				
12	4	82911467N-	82911466-						
#8 Ø3.6 mm	Machined	16	1.5	82913601A	82913600A	-	6.5	A	
		14	2.5	82913603A	82913602A				
		12	4	82913605A	82913604A				
		10	6.0	82913607A	82913606A				
		8	10.0	82913609A	82913608A				

(1) contact reeled (2) loose contact
 Example: RM24W3K - Size #20, Machined, AWG24 wire.

Note: all dimensions are in mm

Crimp Contacts (Continued)

First Mate Last Break Contacts

Contact size	Type	Wire size		Part number		Max wire Ø (mm)	Max insulator Ø (mm)	Color band		Available plating
		AWG	mm ²	Male	Female			Front	Rear	
#16 Ø1.6 mm Longer male contact (+1mm)	Machined	30-28	0.05-0.08	RM28M1GE1-	-	0.55	1.1	-	Red	K, J
		26-24	0.13-0.2	RM24M9GE1-		0.8	1.6	Red	Red	
		22-20	0.32-0.52	RM20M13GE1-		1.18	1.8	Black	Red	
				RM20M12GE1-			2.2	Blue	Red	
		20-16	0.52-1.5	RM16M23GE1-		1.8	3.2	-	Red	
		16-14	1.5-2.5	RM14M30GE1-		2.28	-	-	Red	
#16 Ø1.6 mm Shorter female contact (-0.7mm)	Machined	30-28	0.05-0.08	-	RC28M1GE7-	0.55	1.1	-	Blue	K, J
		26-24	0.13-0.2		RC24M9GE7-	0.8	1.6	Red	Blue	
		22-20	0.32-0.52		RC20M13GE7-	1.18	1.8	Black	Blue	
					RC20M12GE7-		2.2	Blue	Blue	
		20-16	0.52-1.5		RC16M23GE7-	1.8	3.2	-	Blue	
		16-14	1.5-2.5		RC14M30GE7-	2.28	-	-	Blue	

How to make FMLB / LMFB connection

Contact 1 \ Contact 2	Standard male contact	Standard female contact	Longer male contact
Standard male contact		✓	
Standard female contact	✓		✓ FMLB
Shorter female contact	✓ LMFB		

First Mate Last Break contacts should be chosen only if the cavity is not marked with the ground symbol. For cavities marked with the ground symbol, standard contacts will fulfill the same role as a first mate, last break contact used in a standard cavity.



Ground symbol

Tooling

Crimp Tool Table

Standard contacts

Contact size	Part number	Head*	Handles*	Extraction tools
#20 Ø1 mm	RM/RC 24W3K	S20RCM	SHANDLES	RX20D44
	RM/RC 20W3K			
	RM/RC 18W3K			
	SM 24WL3S*(1)	S20SCM20		
	SC 24WL3S*(1)			
SM/SC 20WL3S*(1)	S16RCM20	RX2025GE1		
RM/RC 28M1*				
RM/RC 24M9*				
RM/RC 20M13*				
RM/RC 20M12*				
RM/RC 16M23*		S16RCM16		
RM/RC 14M30*		S16RCM14		
SM/SC 24ML1*(1)		S16SCM20		
SM/SC 20ML1*(1)		S16SCML1		
SM/SC 16ML1*(1)				
SM/SC 14ML1*(1)				
SM/SC 16ML11*(1)	S16SCML11			

(1) loose contact * endurance of SHANDLES & Head tools = 50,000 cycles

Contact size	Part number	Tool with separate locator			Extraction tools
		Hand tool	Positioner + locator setting		
#12 Ø2.4 mm	82911457N* / 82911456*	M317	VGE10077A	1-2	51060210924
	82911459N* / 82911458*			2	
	82911461N* / 82911460*			2	
	82911463N* / 82911462*			3	
	82911465N* / 82911464*			3	
	82911467N* / 82911466*			4	
#8 Ø3.6 mm	82913601A / 82913600A	M317	VGE10078A	3	51060210936
	82913603A / 82913602A			3	
	82913605A / 82913604A			4	
	82913607A / 82913606A			5	
	82913609A / 82913608A			6/7	

* see page 169 for plating options and other contact details

Specific contacts (First mate Last break contacts)

Contact size	Part number*	Hand tools (SHANDLES) head	Tool with separate locator			Extraction tools			
			Hand tool	Positioner + locator setting					
#16 Ø1 mm Longer RM contact	RM28M1GE1K	S16RCM20	-	-	-	RX2025GE1			
	RM24M9GE1K								
	RM20M13GE1K								
	RM16M23GE1K	S16RCM16					MH860	MH86186	6/8
	RM20M12GE1K	S16RCM14					-	-	-
RM14M30GE1K									
#16 Ø1 mm Shorter RC contact	RC28M1GE7K	S16RCM20	MH860	MH86164G	4/6				
	RC24M9GE7K				5/6				
	RC20M13GE7K				5/7				
	RC20M12GE7K	S16RCM16			6/8				
	RC16M23GE7K								
	RC14M30GE7K	S16RCM14			M317	UH25	3		

* example of plating, for other plating consult us.

Coaxial contacts

Consult us

SOURIAU
souriau-industrial.com
contactindustry@souriau.com



X-ON Electronics

Largest Supplier of Electrical and Electronic Components

Click to view similar products for [Standard Circular Connector](#) category:

Click to view products by [Sunbank](#) manufacturer:

Other Similar products are found below :

[C015](#) [10F006](#) [001](#) [1](#) [5M2530B10P](#) [600247N007](#) [600259N006](#) [600273N007](#) [600432N009](#) [6280-2PG-519](#) [6280-3PG-311](#) [6280-3SG-311](#)
[6280-7SG-3DC](#) [6280-7SG-522](#) [6282-5PG-311](#) [6282-6PG-519](#) [6282-8SG-311](#) [6283-11](#) [6283-15](#) [6290](#) [6293](#) [6382-2PG-311](#) [6382-2PG-3DC](#)
[6382-2SG-321](#) [6382-2SG-3DC](#) [6382-4SG-516](#) [67-03E20-37P](#) [681-PMG](#) [CXS3102A14S2P](#) [CXS3102A181S](#) [CXS3106A14S6S](#) [MB12P-1](#)
[MB12R-6](#) [7251-2PG-300](#) [7251-2SG-300](#) [7251-4PG-300](#) [7251-4SG-300](#) [7251-5PG-300](#) [7251-5SG-300](#) [7251-6SG-300](#) [7251-7PG-300](#) [7251-](#)
[8PG-300](#) [7271-6SG-300](#) [7282-3PG-300-CH3](#) [73000005663](#) [75-190011-03P](#) [75-190216-08S](#) [75-190218-10P](#) [75-214636-52P](#) [75-474118-10P](#)
[75-474211-03P](#) [75-474218-19S](#) [75-474618-01S](#)