

SERIES 1830 - SINGLE AND DOUBLE-POLE ROCKER SWITCHES

TO 20 (4) A 250 V AC







PRODUCT FEATURES

- ◆ 100 million times proven switching principle
- ◆ mechanical life endurance up to 1 million switching cycles
- ◆ Wide variety
- ◆ Variants with IP 67 or dust protection insert
- ◆ Two housing variants
- ◆ Actuating characteristic
- ◆ Illuminated and non-illuminated variants
- ◆ Approval for 400 V (product-dependent)

ON REQUEST

- ◆ Other colors
- ◆ Other rocker printings
- ◆ Other printing variants
- ◆ Snap-on customized actuators
- ◆ Cable assembly

Mechanical life endurance	10E4 5E4 (basic type 1839) 1E6 (product-dependent)
Inrush current (capacitive)	120 A / 50 A (contact pair Ag / Cu and basic type 1834)
Contact resistance (new condition)	< 100 mOhm (1 A 12 V DC)
Insulation resistance (new condition)	> 100 MOhm (500 V DC)
Proof tracking	250 PTI
Protection type	IP 40 / IP 67 (product-dependent)
Ambient temperature	terminal side -20 °C ... +105 °C / ... +85 °C / ... +100 °C actuating side -20 °C ... +55 °C
Flammability	UL 94 V-2 UL 94 V-0
Glow wire test temperature	850 °C
Material	actuator PA / PC housing PA terminals silver plated / tinned
Plug force of the terminals	≤ 80 N
Approval marks	 /  /  / 
Suitable for appliances of protection class II	



SERIES 1830 - SINGLE AND DOUBLE-POLE ROCKER SWITCHES

TO 20 (4) A 250 V AC

 single-pole	ON / OFF switch (SPST)							Changeover switch (SPDT momentary)	ON / OFF switch (SPST)						
	1830.3111	1830.3112	1830.3118	1830.3119	1830.8112	1830.0102	1830.6103		1835.3902	1831.0114	1831.3312	1831.3313	1831.3317	1831.3606	1831.3607
Lighting voltage in V	230	230	230	230	230	230	230	230							
Actuator color / printing															
Housing color															
20 (4) A 250 V AC 1E4	●	●	●	●	●					●	●	●	●	●	●
20 (4) A 250 V AC															
16 (4) A 250 V AC 1E4															
10 (8) A 400 V AC 5E4															
10 (8) A 250 V AC 5E4	●	●	●	●	●					●	●	●	●	●	●
10 (4) A 250 V AC 1E4															
10 A 12 V DC															
6 (4) A 250 V AC 5E4															
6 (4) A 250 V AC 1E4															
6 (4) A 250 V AC															
4 (2) A 250 V AC 1E4															
30 mA 12 V DC									●						
16 A 250 V AC 1 HP	●	●	●	●	●					●	●	●	●	●	●
16 A 125 V AC 1 HP															
16 A 250 V AC 1/2 HP															
16 A 125 V AC 1/3 HP										●	●	●	●	●	●
16 A 125 V AC 1/4 HP															
6 A 250 V AC 1/2 HP															
6 A 125 V AC 1/4 HP															
6 A 125 - 250 V AC 1/8 HP															
6 A 125 V AC 1/10 HP															
4 A 250 V AC 1/10 HP															
Terminal type															
Terminal description	6.3	6.3	6.3	6.3	6.3			6.3		6.3	6.3	6.3	6.3	6.3	6.3
Contact distance in mm	≥ 3	≥ 3	≥ 3	≥ 3	≥ 3	≥ 3	≥ 3	≥ 3		≥ 3	≥ 3	≥ 3	≥ 3	≥ 3	≥ 3
Contact material	Ag	Ag	Ag	Ag	Ag	Ag	Ag	Ag		Ag	Ag	Ag	Ag	Ag	Ag
EN 60335 cap. 30 conform "G"				●									●	●	●
Miscellaneous					lower lying flange		lower lying flange		external lamp connection two-pole size					housing with 2 separating gates	housing with 2 separating gates
Stock version		●	●											●	●

SERIES 1830 - SINGLE AND DOUBLE-POLE ROCKER SWITCHES





TO 20 (4) A 250 V AC

single-pole		ON / OFF switch (SPST)						Normally open contact (SPNO)				Changeover switch (SPDT)			
Lighting voltage in V		1831.3815	1831.3933	1831.8112	1832.3508	1831.3311	1831.1107	1831.1202	1831.3402	1831.8202	1831.1253	1833.3312	1833.1102	1833.3307	1833.7102
Actuator color / printing															
Housing color		Black	Black	Black	Black	White	Black	Black	Black	Black	Black	Black	Black	Black	Black
20 (4) A 250 V AC 1E4		•	•	•	•										
20 (4) A 250 V AC						•									
16 (4) A 250 V AC 1E4											•				
10 (8) A 400 V AC 5E4															
10 (8) A 250 V AC 5E4		•	•	•	•	•									
10 (4) A 250 V AC 1E4							•					•	•	•	
10 A 12 V DC															
6 (4) A 250 V AC 5E4							•					•	•	•	
6 (4) A 250 V AC 1E4															
6 (4) A 250 V AC															
4 (2) A 250 V AC 1E4								•	•	•					
30 mA 12 V DC										•					
16 A 250 V AC 1 HP		•	•	•	•	•									
16 A 125 V AC 1 HP												•			
16 A 250 V AC 1/2 HP															
16 A 125 V AC 1/3 HP		•	•	•	•	•									
16 A 125 V AC 1/4 HP											•				
6 A 250 V AC 1/2 HP							•					•	•	•	
6 A 125 V AC 1/4 HP							•					•	•	•	
6 A 125 - 250 V AC 1/8 HP															
6 A 125 V AC 1/10 HP								•	•	•					
4 A 250 V AC 1/10 HP								•	•	•					
Terminal type															
Terminal description		6.3	6.3	6.3	6.3	6.3	4.8	4.8	6.3	6.3	4.8	6.3	4.8	6.3	4.8
Contact distance in mm		≥ 3	≥ 3	≥ 3	≥ 3	≥ 3	≥ 3	≥ 3	≥ 3	≥ 3	≥ 3	≥ 3	≥ 3	≥ 3	≥ 3
Contact material		Ag	Ag	Ag	Ag	Ag	Ag	Ag	Ag	Ag	Au	Ag	Ag	Ag	Ag
EN 60335 cap. 30 conform "G"						•								•	
Miscellaneous		1E6 mechanical life endurance IP 67		lower lying flange	two-pole size					lower lying flange					lower lying flange
Stock version				•		•	•	•	•						

ROCKER SWITCHES
PUSHBUTTON SWITCHES
TOGGLE SWITCHES
SLIDE SWITCHES
ROTARY SWITCHES
FOOT SWITCHES
FACT AND KEY SWITCHES
SNAP-ACTION SWITCHES
MICRO-SIGNAL SWITCHES
SENSORS

SERIES 1830 - SINGLE AND DOUBLE-POLE ROCKER SWITCHES

TO 20 (4) A 250 V AC

		Changeover switch with OFF position in the center (SPDT - Center OFF)							Changeover switch (SPDT momentary)					
		1838.0305	1838.3901	1838.1402	1838.1502	1838.1509	1838.1602	1838.4307	1838.8302	1838.3402	1838.3502	1833.1202	1833.3402	1833.6202
Lighting voltage in V														
Actuator color / printing														
Housing color														
20 (4) A 250 V AC 1E4														
20 (4) A 250 V AC														
16 (4) A 250 V AC 1E4		●												
10 (8) A 400 V AC 5E4														
10 (8) A 250 V AC 5E4														
10 (4) A 250 V AC 1E4														
10 A 12 V DC														
6 (4) A 250 V AC 5E4														
6 (4) A 250 V AC 1E4		●												
6 (4) A 250 V AC		●												
4 (2) A 250 V AC 1E4		●												
30 mA 12 V DC														
16 A 250 V AC 1 HP														
16 A 125 V AC 1 HP		●												
16 A 250 V AC 1/2 HP		●												
16 A 125 V AC 1/3 HP		●												
16 A 125 V AC 1/4 HP														
6 A 250 V AC 1/2 HP														
6 A 125 V AC 1/4 HP														
6 A 125 - 250 V AC 1/8 HP		●												
6 A 125 V AC 1/10 HP		●												
4 A 250 V AC 1/10 HP		●												
Terminal type														
Terminal description														
Contact distance in mm		≥ 3												
Contact material		Ag												
EN 60335 cap. 30 conform "G"														
Miscellaneous		momentary function both sides 1E6 mechanical life endurance IP 67 momentary function both sides momentary function one side momentary function one side momentary function both sides lower lying flange momentary function both sides lower lying flange												
Stock version		●												

ROCKER SWITCHES

PUSHBUTTON SWITCHES

TOGGLE SWITCHES

SLIDE SWITCHES

ROTARY SWITCHES

FOOT SWITCHES

FACT AND KEY SWITCHES

SNAP-ACTION SWITCHES

MICRO-SIGNAL SWITCHES

SENSORS

SERIES 1830 - SINGLE AND DOUBLE-POLE ROCKER SWITCHES

TO 20 (4) A 250 V AC

 double-pole	ON / OFF switch (DPST)								Changeover switch (DPDT)		ON / OFF switch (DPST)			
	1835.3419	1835.3111	1835.3112	1835.3114	1835.3118	1835.9413	1835.3102	1835.3105	1835.3108	1835.7108	1835.3802	1835.3116	1835.3107	1832.1612
Lighting voltage in V	400	230	230	230	230	230	230	230	230	230	230	115-230	12	
Actuator color / printing														
Housing color														
20 (4) A 250 V AC 1E4	•	•	•	•	•	•						•		•
20 (4) A 250 V AC														
16 (4) A 250 V AC 1E4														
10 (8) A 400 V AC 5E4	•													
10 (8) A 250 V AC 5E4	•	•	•	•	•	•						•		•
10 (4) A 250 V AC 1E4							•	•	•	•	•			
10 A 12 V DC													•	
6 (4) A 250 V AC 5E4							•	•	•	•	•			
6 (4) A 250 V AC 1E4														
6 (4) A 250 V AC														
4 (2) A 250 V AC 1E4														
30 mA 12 V DC														
16 A 250 V AC 1 HP	•	•	•	•	•	•						•		•
16 A 125 V AC 1 HP														
16 A 250 V AC 1/2 HP														
16 A 125 V AC 1/3 HP														•
16 A 125 V AC 1/4 HP														
6 A 250 V AC 1/2 HP							•	•	•	•	•			
6 A 125 V AC 1/4 HP														
6 A 125 - 250 V AC 1/8 HP														
6 A 125 V AC 1/10 HP														
4 A 250 V AC 1/10 HP														
Terminal type														
Terminal description	6.3	6.3	6.3	6.3	6.3		6.3	6.3	6.3	6.3	6.3	6.3	6.3	4.8
Contact distance in mm	≥ 3	≥ 3	≥ 3	≥ 3	≥ 3	≥ 3	≥ 3	≥ 3	≥ 3	≥ 3	≥ 3	≥ 3	≥ 3	≥ 3
Contact material	Ag	Ag	Ag	Ag	Ag	Ag	Ag	Ag	Ag	Ag	Ag	Ag	Ag	Ag
EN 60335 cap. 30 conform "G"														
Miscellaneous	cover frame 33.2 long					PCB holder 248.103.011 mounted lower lying flange				lower lying flange				cover frame 33.2 long
Stock version			•	•	•		•	•	•					

ROCKER SWITCHES
PUSHBUTTON SWITCHES
TOGGLE SWITCHES
SLIDE SWITCHES
ROTARY SWITCHES
FOOT SWITCHES
FACT AND KEY SWITCHES
SNAP-ACTION SWITCHES
MICRO-SIGNAL SWITCHES
SENSORS

SERIES 1830 - SINGLE AND DOUBLE-POLE ROCKER SWITCHES

TO 20 (4) A 250 V AC

		ON / OFF switch (DPST)	1832.3311	1832.3312	1832.3313	1832.3602	1832.6112	1832.7103	1832.8112	1832.9103	1832.0113	1832.1102	1832.3307	1832.9101	Normally open contact (DPNO)	1832.3407	1832.8204
Lighting voltage in V																	
Actuator color / printing																	
Housing color																	
20 (4) A 250 V AC 1E4			●	●	●	●	●	●	●	●							
20 (4) A 250 V AC																	
16 (4) A 250 V AC 1E4											●						
10 (8) A 400 V AC 5E4																	
10 (8) A 250 V AC 5E4			●	●	●	●	●	●	●	●							
10 (4) A 250 V AC 1E4												●	●	●			
10 A 12 V DC																	
6 (4) A 250 V AC 5E4												●	●	●			
6 (4) A 250 V AC 1E4																	
6 (4) A 250 V AC																	
4 (2) A 250 V AC 1E4																●	●
30 mA 12 V DC																	
16 A 250 V AC 1 HP			●	●	●	●	●	●	●	●							
16 A 125 V AC 1 HP										●							
16 A 250 V AC 1/2 HP											●						
16 A 125 V AC 1/3 HP			●	●	●	●	●	●	●								
16 A 125 V AC 1/4 HP											●						
6 A 250 V AC 1/2 HP												●	●	●			
6 A 125 V AC 1/4 HP												●	●	●			
6 A 125 - 250 V AC 1/8 HP																	
6 A 125 V AC 1/10 HP																●	●
4 A 250 V AC 1/10 HP																●	●
Terminal type																	
Terminal description			6.3	6.3	6.3	6.3	4.8		6.3			4.8	6.3			6.3	6.3
Contact distance in mm			≥ 3	≥ 3	≥ 3	≥ 3	≥ 3	≥ 3	≥ 3	≥ 3	≥ 3	≥ 3	≥ 3	≥ 3		≥ 3	≥ 3
Contact material			Ag	Ag	Ag	Ag	Ag	Ag	Ag	Ag	Ag	Ag	Ag	Ag		Ag	Ag
EN 60335 cap. 30 conform "G"					●												
Miscellaneous						cover frame 33.2 long	lower lying flange	lower lying flange	lower lying flange	lower lying flange	dust protection inlay			lower lying flange			lower lying flange
Stock version			●	●		●						●	●				

ROCKER SWITCHES

PUSHBUTTON SWITCHES

TOGGLE SWITCHES

SLIDE SWITCHES

ROTARY SWITCHES

FOOT SWITCHES

FACT AND KEY SWITCHES

SNAP-ACTION SWITCHES

MICRO-SIGNAL SWITCHES

SENSORS

SERIES 1830 - SINGLE AND DOUBLE-POLE ROCKER SWITCHES

TO 20 (4) A 250 V AC

		Changeover switch (DPDT)							Changeover switch with OFF position in the center (DPDT - Center OFF)							
		1834.3311	1834.3312	1834.1102	1834.3302	1834.3309	1834.3603	1834.6103	1839.3512	1839.1402	1839.1407	1839.1410	1839.1502	1839.1507	1839.1509	1839.1518
Lighting voltage in V																
Actuator color / printing																
Housing color																
20 (4) A 250 V AC 1E4																
20 (4) A 250 V AC																
16 (4) A 250 V AC 1E4		●	●						●							
10 (8) A 400 V AC 5E4																
10 (8) A 250 V AC 5E4																
10 (4) A 250 V AC 1E4				●	●	●	●	●								
10 A 12 V DC																
6 (4) A 250 V AC 5E4				●	●	●	●	●								
6 (4) A 250 V AC 1E4										●	●	●	●	●	●	●
6 (4) A 250 V AC																
4 (2) A 250 V AC 1E4																
30 mA 12 V DC																
16 A 250 V AC 1 HP																
16 A 125 V AC 1 HP																
16 A 250 V AC 1/2 HP		●	●						●							
16 A 125 V AC 1/3 HP									●							
16 A 125 V AC 1/4 HP		●	●													
6 A 250 V AC 1/2 HP				●	●	●	●	●								
6 A 125 V AC 1/4 HP				●	●	●	●	●								
6 A 125 - 250 V AC 1/8 HP										●	●	●	●	●	●	●
6 A 125 V AC 1/10 HP																
4 A 250 V AC 1/10 HP																
Terminal type																
Terminal description		6.3	6.3	4.8	6.3	6.3	6.3	4.8	6.3	4.8	4.8	4.8	4.8	4.8	4.8	4.8
Contact distance in mm		≥ 3	≥ 3	≥ 3	≥ 3	≥ 3	≥ 3	≥ 3	≥ 3	≥ 3	≥ 3	≥ 3	≥ 3	≥ 3	≥ 3	≥ 3
Contact material		Ag	Ag	Ag	Ag	Ag	Ag	Ag	Ag	Ag	Ag	Ag	Ag	Ag	Ag	Ag
EN 60335 cap. 30 conform "G"							●									
Miscellaneous							cover frame 33.2 long	lower lying flange				dust protection inlay momentary function both sides	dust protection inlay momentary function both sides			dust protection inlay
Stock version					●					●	●			●		

ROCKER SWITCHES

PUSHBUTTON SWITCHES

TOGGLE SWITCHES

SLIDE SWITCHES

ROTARY SWITCHES

FOOT SWITCHES

FACT AND KEY SWITCHES

SNAP-ACTION SWITCHES

MICRO-SIGNAL SWITCHES

SENSORS

SERIES 1830 - SINGLE AND DOUBLE-POLE ROCKER SWITCHES

TO 20 (4) A 250 V AC

 <p>double-pole</p>		1839.1602	1839.2203	1839.3402	1839.3502	1839.3503	1839.3602	1839.7304	1839.3352	1839.0105	Changeover switch (DPDT momentary)		1834.3402
Lighting voltage in V													
Actuator color / printing													
Housing color													
20 (4) A 250 V AC 1E4													
20 (4) A 250 V AC													
16 (4) A 250 V AC 1E4													
10 (8) A 400 V AC 5E4													
10 (8) A 250 V AC 5E4													
10 (4) A 250 V AC 1E4													
10 A 12 V DC													
6 (4) A 250 V AC 5E4													
6 (4) A 250 V AC 1E4													
6 (4) A 250 V AC													
4 (2) A 250 V AC 1E4													
30 mA 12 V DC													
16 A 250 V AC 1 HP													
16 A 125 V AC 1 HP													
16 A 250 V AC 1/2 HP													
16 A 125 V AC 1/3 HP													
16 A 125 V AC 1/4 HP													
6 A 250 V AC 1/2 HP													
6 A 125 V AC 1/4 HP													
6 A 125 - 250 V AC 1/8 HP													
6 A 125 V AC 1/10 HP													
4 A 250 V AC 1/10 HP													
Terminal type													
Terminal description													
Contact distance in mm													
Contact material													
EN 60335 cap. 30 conform "G"													
Miscellaneous													
Stock version													

ROCKER SWITCHES

PUSHBUTTON SWITCHES

TOGGLE SWITCHES

SLIDE SWITCHES

ROTARY SWITCHES

FOOT SWITCHES

FACT AND KEY SWITCHES

















SNAP-ACTION SWITCHES

MICRO-SIGNAL SWITCHES

SENSORS

SERIES 1830 - SINGLE AND DOUBLE-POLE ROCKER SWITCHES

TO 20 (4) A 250 V AC

Lamp	Lamp				
	1837.118	1837.2504	1837.3102	1837.8102	1837.8108
					
Lighting voltage in V	230	230	230	230	230
Actuator color / printing					
Housing color					
20 (4) A 250 V AC 1E4					
20 (4) A 250 V AC					
16 (4) A 250 V AC 1E4					
10 (8) A 400 V AC 5E4					
10 (8) A 250 V AC 5E4					
10 (4) A 250 V AC 1E4					
10 A 12 V DC					
6 (4) A 250 V AC 5E4					
6 (4) A 250 V AC 1E4					
6 (4) A 250 V AC					
4 (2) A 250 V AC 1E4					
30 mA 12 V DC					
16 A 250 V AC 1 HP					
16 A 125 V AC 1 HP					
16 A 250 V AC 1/2 HP					
16 A 125 V AC 1/3 HP					
16 A 125 V AC 1/4 HP					
6 A 250 V AC 1/2 HP					
6 A 125 V AC 1/4 HP					
6 A 125 - 250 V AC 1/8 HP					
6 A 125 V AC 1/10 HP					
4 A 250 V AC 1/10 HP					
Terminal type					
Terminal description	4.8		6.3	6.3	6.3
Contact distance in mm					
Contact material					
EN 60335 cap. 30 conform "G"					
Miscellaneous		lower lying flange		size basic type 1835	size basic type 1835
Stock version					

ROCKER SWITCHES

PUSHBUTTON SWITCHES

TOGGLE SWITCHES

SLIDE SWITCHES

ROTARY SWITCHES

FOOT SWITCHES

FACT AND KEY SWITCHES

SNAP-ACTION SWITCHES

MICRO-SIGNAL SWITCHES

SENSORS

SERIES 1830 - SINGLE AND DOUBLE-POLE ROCKER SWITCHES

TO 20 (4) A 250 V AC



Basic types 1830, 1831, 1833 and 1838
single-pole
illuminated / non-illuminated

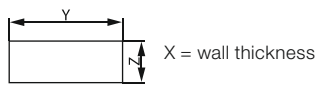

X	Y	Z
0.75 ... 1.25	30 ^{-0.1}	11 ^{+0.1}
1.25 ... 2	30.2 ^{-0.1}	11 ^{+0.1}
2 ... 3	30.6 ^{-0.1}	11 ^{+0.1}

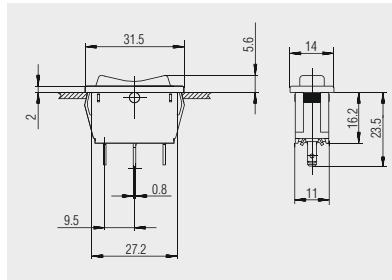

Quick-connect terminal 2.8 x 0.8
1838.4307

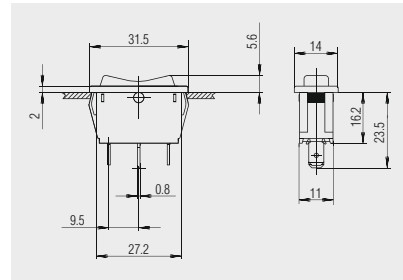

Quick-connect terminal 4.8 x 0.8
basic type 1838

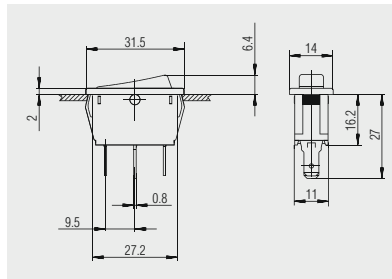

Quick-connect terminal 4.8 x 0.8
basic types 1830, 1831 and 1833

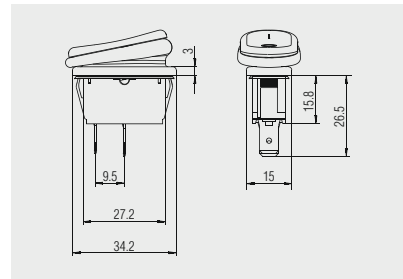

Quick-connect terminal 6.3 x 0.8
1831.3815

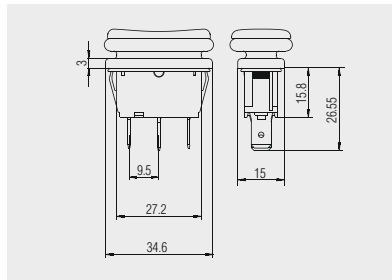

Quick-connect terminal 6.3 x 0.8
1838.3901

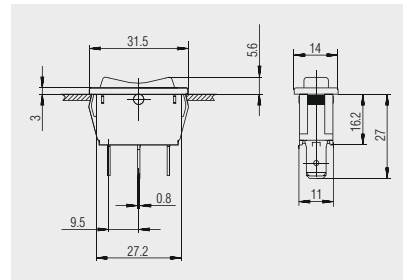

Quick-connect terminal 6.3 x 0.8
basic type 1838

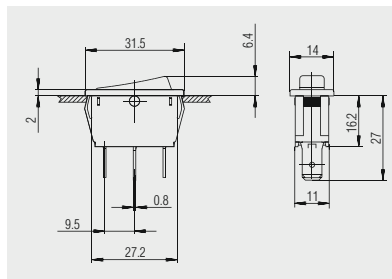

Quick-connect terminal 6.3 x 0.8
basic types 1831 and 1833

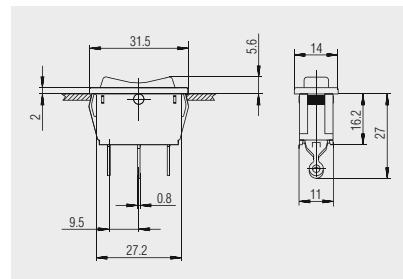

Solder terminal
basic type 1838

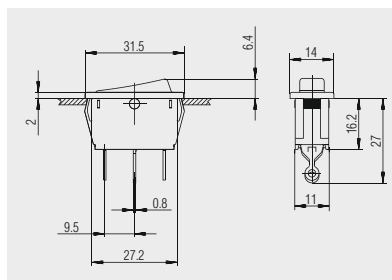

Solder terminal
basic types 1830 and 1831

SERIES 1830 - SINGLE AND DOUBLE-POLE ROCKER SWITCHES

TO 20 (4) A 250 V AC



Basic types 1832, 1834, 1835 and 1839
double-pole
illuminated / non-illuminated

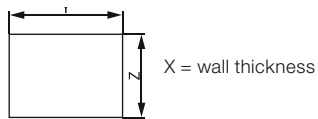

X	Y	Z
0.75 ... 1.25	30 ^{-0.1}	22 ^{+0.2}
1.25 ... 2	30.2 ^{-0.1}	22 ^{+0.2}
2 ... 3	30.6 ^{-0.1}	22 ^{+0.2}

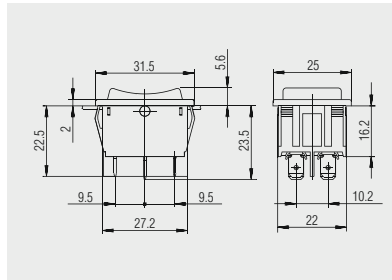

Quick-connect terminal 4.8 x 0.8

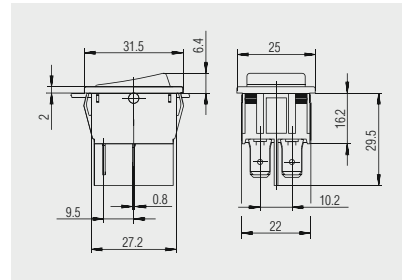

Quick-connect terminal 6.3 x 0.8 / 4.8
basic types 1832, 1834 and 1835

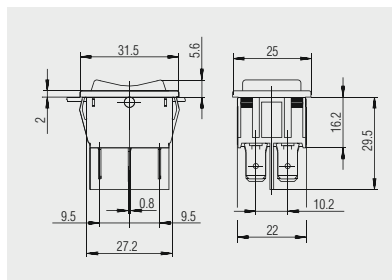

Quick-connect terminal 6.3 x 0.8
basic type 1839

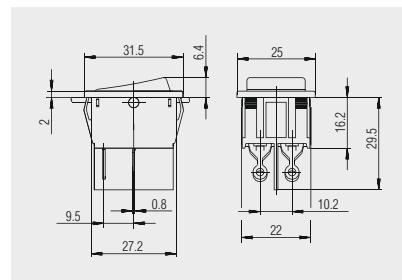

Solder terminal
basic type 1832

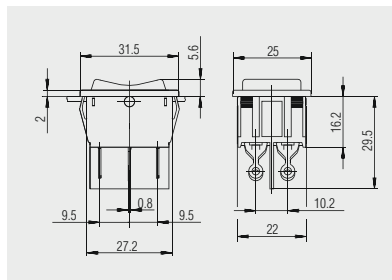

Solder terminal
basic type 1839

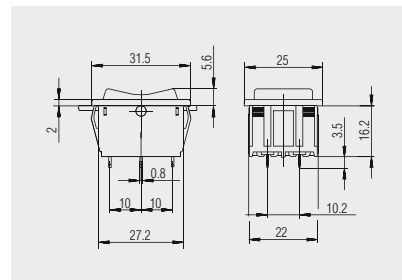

PCB terminal
basic type 1839



Basic types 1830, 1831 and 1833
single-pole, lower lying flange
illuminated / non-illuminated

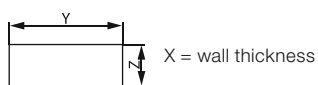

X	Y	Z
0.75 ... 1.25	30 ^{-0.1}	11 ^{+0.1}
1.25 ... 2	30.2 ^{-0.1}	11 ^{+0.1}
2 ... 3	30.6 ^{-0.1}	11 ^{+0.1}

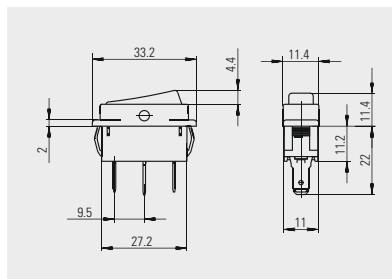

Quick-connect terminal 4.8 x 0.8
basic types 1830, 1831 and 1833

ROCKER SWITCHES

PUSHBUTTON SWITCHES

TOGGLE SWITCHES

SLIDE SWITCHES

ROTARY SWITCHES

FOOT SWITCHES

FACT AND KEY SWITCHES

SNAP-ACTION SWITCHES

MICRO-SIGNAL SWITCHES

SENSORS

SERIES 1830 - SINGLE AND DOUBLE-POLE ROCKER SWITCHES

TO 20 (4) A 250 V AC



Basic types 1832, 1834, 1835 and 1839
double-pole, lower lying flange
illuminated / non-illuminated

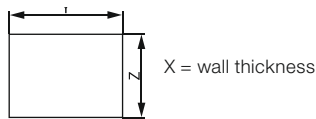

X	Y	Z
0.75 ... 1.25	30 ^{-0.1}	22 ^{+0.2}
1.25 ... 2	30.2 ^{-0.1}	22 ^{+0.2}
2 ... 3	30.6 ^{-0.1}	22 ^{+0.2}

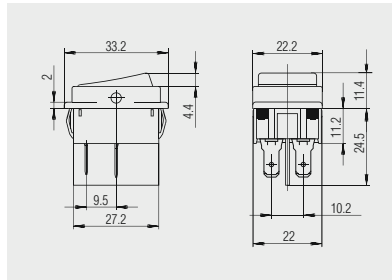

Quick-connect terminal 4.8 x 0.8
basic types 1832 and 1834

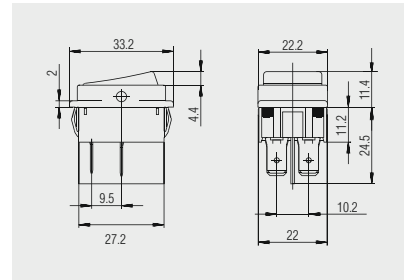

Quick-connect terminal 6.3 x 0.8
basic type 1832

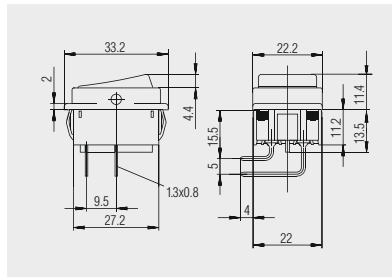

PCB terminal angled
basic types 1832 and 1835

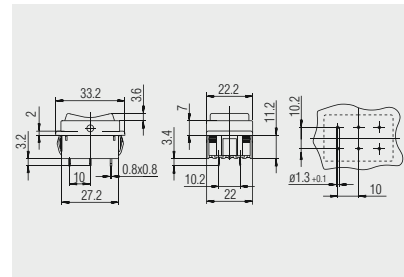

PCB terminal
basic type 1839

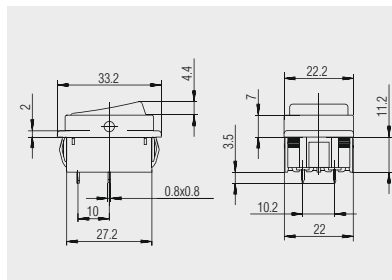

PCB terminal
basic types 1832 and 1835



Basic type 1837 lamp
single and double-pole

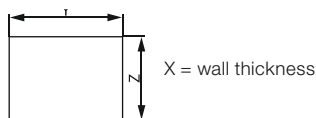

X	Y	Z
0.75 ... 1.25	30 ^{-0.1}	22 ^{+0.2}
1.25 ... 2	30.2 ^{-0.1}	22 ^{+0.2}
2 ... 3	30.6 ^{-0.1}	22 ^{+0.2}

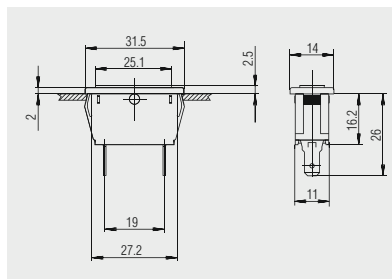

Quick-connect terminal 4.8 x 0.8
single-pole size

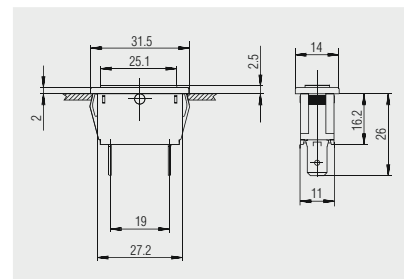

Quick-connect terminal 6.3 x 0.8
single-pole size

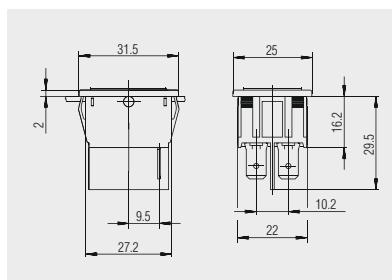

Quick-connect terminal 6.3 x 0.8
double-pole size

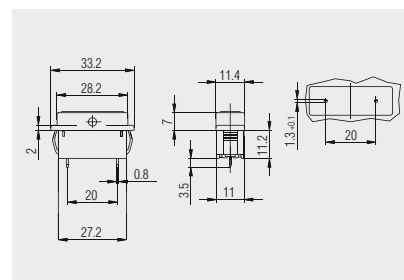

PCB terminal
lower lying flange
1837.2504

SERIES 1830 - SINGLE AND DOUBLE-POLE ROCKER SWITCHES

TO 20 (4) A 250 V AC



Protection ap
203.731.011

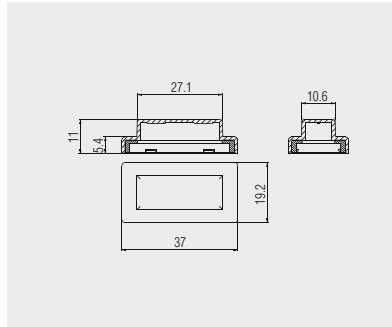

Transparent PVC - protection cap for single-pole switches of basic types 1830, 1831, 1833 and 1838. Serves as dust and water protection of the actuation side.



Protection cap
203.201.011

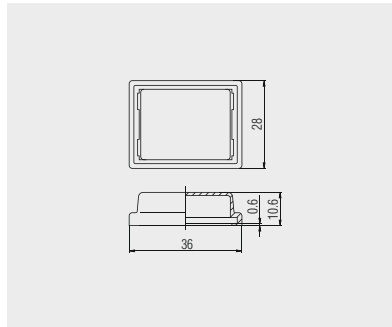

Transparent PVC - protection cap for double-pole switches of basic types 1832, 1834, 1835 and 1839 with frame length 33.2 mm. Serves as dust and water protection of the actuation side.



Protection cap
203.078.011

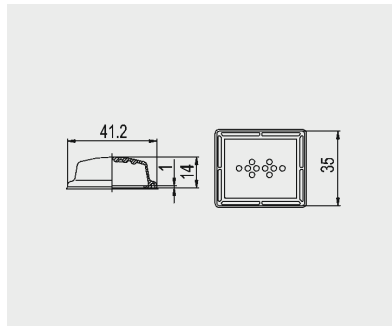

Transparent PVC-protection cap with burling. Serves as dust and water protection of the actuation side for double-pole basic types 1832, 1834, 1835 and 1839 with standard flange length 30 mm.



Dummy cap
203.145.051



Housing
217.132.031

Housing and dummy cap for double-pole size of basic types 1830, 1831, 1833, 1837 and 1838 of PA black.

Housing and dummy cap must be assembled by the customer and makes only sense in combination



Dummy cap
203.146.051



Housing
217.127.491

Housing and dummy cap for double-pole size of basic types 1832, 1834, 1835 and 1839 of PA black.

Housing and dummy cap must be assembled by the customer and makes only sense in combination

ROCKER SWITCHES

PUSHBUTTON SWITCHES

TOGGLE SWITCHES

SLIDE SWITCHES

ROTARY SWITCHES

FOOT SWITCHES

FACT AND KEY SWITCHES

SNAP-ACTION SWITCHES

MICRO-SIGNAL SWITCHES

SENSORS

X-ON Electronics

Largest Supplier of Electrical and Electronic Components

Click to view similar products for [Rocker Switches](#) category:

Click to view products by [Marquardt](#) manufacturer:

Other Similar products are found below :

[VKD2GHNB-00000-000](#) [VSD2GNNB-00000-000](#) [6-1571986-5](#) [6-1571986-9](#) [632422-4B-KD](#) [7036WWCDBX653+U622](#) [8055K52Z7V](#)
[8138K20E6M50](#) [FMC18A2200002](#) [84206L](#) [84312LX](#) [PREDD4-07F-BB0FW](#) [PREDD5-07F-BB0GW](#) [PRFDD1-16F-BB000](#) [PRFDD3-16F-](#)
[BB000](#) [1-1634201-0](#) [999-16702-001](#) [A101J2ZQ004](#) [A101J4ZQ004](#) [A101J51CB0004](#) [A107J51ZQ0004](#) [A201J1AQ004](#) [A201J1AV2Q004](#)
[A201J3ZB004](#) [A201J50ZQ004](#) [A203J51ZQ0004](#) [A226L11YZQ](#) [A22L11A](#) [A435S1YZQ](#) [H8500XBBBBL-A](#) [H8653VBBG2577W](#)
[HB130CHNWWNAAC](#) [1251.0303](#) [AE205J60V3B004](#) [RH110C2NBB](#) [1352.0107](#) [1363.0201](#) [AML25GBF2AA03GR](#) [1571099-3](#) [1571987-4](#)
[1571987-5](#) [1571989-7](#) [B123J77V7B2](#) [B226J50W4Q22P](#) [B433J37ZQ22M](#) [160212E](#) [1801.1164](#) [1831.1102](#) [1833.3402](#) [1837.1118](#)