

# Chip Monolithic Ceramic Capacitors for Automotive

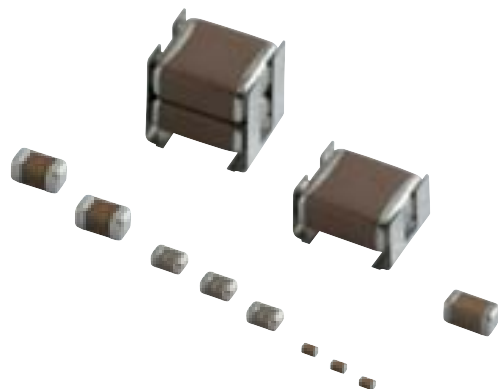

## Explanation of Symbols in This Catalog

---

**Ultra-compact** L x W dimension: products of 0.6x0.3 mm or less

---

**AEC-Q200** AEC-Q200 compliant product

---

**Anti-noise** Product suitable for acoustic noise reduction and low distortion  
This product suppresses acoustic noise, which occurs when a ceramic capacitor is used, by devising the materials and configuration.

---

**Fail safe** Fail safe product  
This capacitor is designed to prevent failures as much as possible by short mode.

---

**Deflecting crack** Product resistant to deflection cracking  
This capacitor is designed to prevent failures as much as possible by short mode caused by cracking when there is board deflection.

---

**Soldering crack** Product with solder cracking suppression  
This capacitor is configured with metal terminals or lead wires connected to the chip.  
The metal terminals or lead wires relieve the stress from expansion and contraction of the solder, to suppress solder cracking.  
Also, including capacitor which can be mounted with a conductive adhesive, instead of soldering.

---

### EU RoHS Compliant

---

- All the products in this catalog comply with EU RoHS.
- EU RoHS is "the European Directive 2011/65/EU on the Restriction of the Use of Certain Hazardous Substances in Electrical and Electronic Equipment."
- For more details, please refer to our website 'Murata's Approach for EU RoHS' (<http://www.murata.com/info/rohs.html>).

# Contents

Product specifications are as of March 2014.

Part Numbering .....	p2	
Selection Guide .....	p4	
Capacitance Table .....	p5	
		Cap. Table
<hr/>		
General Purpose Product		
GCM Series .....	p16	p6
<hr/>		
Specially Designed Product to Reduce Shorts GCD Series .....		
	p23	p10
<hr/>		
Specially Designed Product to Reduce Shorts & Resin Electrode Product		
GCE Series .....	p25	p10
<hr/>		
Conductivity Adhesive Compatible Type		
GCG Series .....	p27	p11
<hr/>		
Resin External Electrode Product		
GCJ Series .....	p32	p12
<hr/>		
High Effective Capacitance & High Allowable Ripple Current		
GC3 Series .....	p38	p14
<hr/>		
Metal Terminal Type KCM Series.....		
	p40	p14
<hr/>		
Metal Terminal Type/High Effective Capacitance & High Allowable Ripple Current KC3 Series .....		
	p43	p14
<hr/>		
⚠Caution/Notice .....	p46	
Introduction of Website SimSurfing .....	p66	
EMICON-FUN! .....	p67	
Product Information .....	p68	

Please check the MURATA home page (<http://www.murata.com/>) if you cannot find the part number in the catalog.

GCM Series

GCD Series

GCE Series

GCG Series

GCJ Series

GC3 Series

KCM Series

KC3 Series

⚠Caution/Notice

## ● Part Numbering

### Chip Monolithic Ceramic Capacitors for Automotive

(Part Number) 

GC	M	18	8	R7	1H	102	K	A37	D
①	②	③	④	⑤	⑥	⑦	⑧	⑨	⑩

#### ① Product ID

#### ② Series

Product ID	Code	Series
<b>GC</b>	<b>3</b>	High effective capacitance & High allowable ripple current
	<b>D</b>	Specially designed product to reduce shorts
	<b>E</b>	Specially designed product to reduce shorts & resin electrode product
	<b>G</b>	Conductivity adhesive compatible type
	<b>J</b>	Resin external electrode product
	<b>M</b>	For automotive
<b>KC</b>	<b>3</b>	Metal terminal type/High effective capacitance & High allowable ripple current
	<b>M</b>	Metal terminal type

#### ③ Chip Dimension (L×W)

Code	Dimension (L×W)	EIA
<b>03</b>	0.6×0.3mm	0201
<b>15</b>	1.0×0.5mm	0402
<b>18</b>	1.6×0.8mm	0603
<b>21</b>	2.0×1.25mm	0805
<b>31</b>	3.2×1.6mm	1206
<b>32</b>	3.2×2.5mm	1210
<b>43</b>	4.5×3.2mm	1812
<b>55</b>	5.7×5.0mm	2220

#### ⑤ Temperature Characteristics

Temperature Characteristic Codes			Temperature Characteristics			Operating Temperature Range	Capacitance Change Each Temperature (%)					
Code	Public STD Code	EIA	Reference Temperature	Temperature Range	Capacitance Change or Temperature Coefficient		-55°C		*3		-10°C	
							Max.	Min.	Max.	Min.	Max.	Min.
<b>5C</b>	C0G	EIA	25°C	25 to 125°C	0±30ppm/°C	-55 to 125°C	0.58	-0.24	0.4	-0.17	0.25	-0.11
<b>5G</b>	X8G	*1	25°C	25 to 150°C	0±30ppm/°C	-55 to 150°C	0.58	-0.24	0.4	-0.17	0.25	-0.11
<b>7U</b>	U2J	EIA	25°C	25 to 125°C *2	-750±120ppm/°C	-55 to 125°C	8.78	5.04	6.04	3.47	3.84	2.21
<b>9E</b>	ZLM	*1	20°C	-25 to 20°C	-4700+1000/-2500ppm/°C	-55 to 125°C	-	-	-	-	-	-
				20 to 85°C	-4700+500/-1000ppm/°C		-	-	-	-	-	-
<b>C7</b>	X7S	EIA	25°C	-55 to 125°C	±22%	-55 to 125°C	-	-	-	-	-	-
<b>D7</b>	X7T	EIA	25°C	-55 to 125°C	+22%, -33%	-55 to 125°C	-	-	-	-	-	-
<b>L8</b>	X8L	*1	25°C	-55 to 150°C	+15%, -40%	-55 to 150°C	-	-	-	-	-	-
<b>R7</b>	X7R	EIA	25°C	-55 to 125°C	±15%	-55 to 125°C	-	-	-	-	-	-
<b>R9</b>	X8R	EIA	25°C	-55 to 150°C	±15%	-55 to 150°C	-	-	-	-	-	-

\*1 Murata Temperature Characteristic Code.

\*2 Rated Voltage 100Vdc max: 25 to 85°C

\*3 -25°C (Reference Temperature 20°C) / -30°C (Reference Temperature 25°C)

#### ④ Height Dimension (T) (Except KC□)

Code	Dimension (T)
<b>3</b>	0.3mm
<b>5</b>	0.5mm
<b>6</b>	0.6mm
<b>8</b>	0.8mm
<b>9</b>	0.85mm
<b>A</b>	1.0mm
<b>B</b>	1.25mm
<b>C</b>	1.6mm
<b>D</b>	2.0mm
<b>E</b>	2.5mm
<b>M</b>	1.15mm
<b>Q</b>	1.5mm
<b>X</b>	Depends on individual standards.

#### ④ Height Dimension (T) (KC□ Only)

Code	Dimension (T)
<b>L</b>	2.8mm
<b>Q</b>	3.7mm
<b>T</b>	4.8mm
<b>W</b>	6.4mm

Continued on the following page.

(Part Number)

GC	M	18	8	R7	1H	102	K	A37	D
1	2	3	4	5	6	7	8	9	10

☐ Continued from the preceding page.

⑥ Rated Voltage

Code	Rated Voltage
0J	DC6.3V
1A	DC10V
1C	DC16V
1E	DC25V
YA	DC35V
1H	DC50V
1J	DC63V
1K	DC80V
2A	DC100V
2E	DC250V
2W	DC450V
2J	DC630V
3A	DC1kV

⑦ Capacitance

Expressed by three-digit alphanumerics. The unit is pico-farad (pF). The first and second figures are significant digits, and the third figure expresses the number of zeros that follow the two numbers.

If there is a decimal point, it is expressed by the capital letter "R."

In this case, all figures are significant digits.

If any letter, other than "R" is included, this indicates the specific part number is a non-standard part.

Ex.)

Code	Capacitance
R50	0.50pF
1R0	1.0pF
100	10pF
103	10000pF

⑧ Capacitance Tolerance

Code	Capacitance Tolerance
C	±0.25pF
D	±0.5pF
J	±5%
K	±10%
M	±20%

⑨ Individual Specification Code

Expressed by three figures.

⑩ Package

Code	Package
L	ø180mm Embossed Taping
D/W	ø180mm Paper Taping
K	ø330mm Embossed Taping
J	ø330mm Paper Taping
B	Bulk
C	Bulk Case

Please contact us if you find any part number not provided in this table.

## Selection Guide for Chip Monolithic Ceramic Capacitors

	Series	Ultra-small (smaller than 0201)	Low dissipation/HiQ	Low ESL	Fail safe	Anti-deflecting crack	Anti-soldering crack	Anti-noise, low distortion	For bonding	Specific applications	Safety standard certified type
For Automotive	GCM <small>page p16</small>										
	GCD <small>p23</small>										
	GCE <small>p25</small>										
	GCG <small>p27</small>										
	GCJ <small>p32</small>										
	GC3 <small>p38</small>										
	KCM <small>p40</small>										
	KC3 <small>p43</small>										
For General Purpose	GRM										
	GA2										
	GA3										
	GJM										
	GJ4										
	GJ8										
	GMA										
	GMD										
	GQM										
	GRJ										
	GR3										
	GR4										
	GR7										
	KRM										
	KR3										
	LLA										
	LLL										
	LLM										
	LLR										
	ZRA										

## Capacitance Table

### How to read the Capacitance Table

LxW (mm)	0.6× 0.3	1.0× 0.5	1.6×0.8		
T max. (mm)	0.33	0.55	0.9		
Rated Voltage (Vdc)	25	50	100	50	10
Cap. / TC Code	C0G	C0G	C0G	C0G	C0
1.0pF	p17	p17	p17	p17	
2.0pF	p17	p17	p17	p17	
3.0pF	p17	p17	p17	p17	
4.0pF	p17	p17	p17	p17	
5.0pF	p17	p17	p17	p17	

→ The values can be narrowed down in the order of size, rated voltage, and temperature characteristics.

→ Refers to the page of the part number list.  
Check the part number list for the applicable product number.

### Temperature Characteristics Table

The Table is colored by temperature characteristic codes. Refer to the following Table for the meaning of each code.

Temperature Characteristic Codes		Temperature Characteristics			Operating Temperature Range	Capacitance Change Each Temperature (%)					
		Reference Temperature	Temperature Range	Capacitance Change or Temperature Coefficient		-55°C		*3		-10°C	
						Max.	Min.	Max.	Min.	Max.	Min.
C0G	EIA	25°C	25 to 125°C	0±30ppm/°C	-55 to 125°C	0.58	-0.24	0.4	-0.17	0.25	-0.11
X8G	*1	25°C	25 to 150°C	0±30ppm/°C	-55 to 150°C	0.58	-0.24	0.4	-0.17	0.25	-0.11
U2J	EIA	25°C	25 to 125°C *2	-750±120ppm/°C	-55 to 125°C	8.78	5.04	6.04	3.47	3.84	2.21
ZLM	*1	20°C	-25 to 20°C	-4700+1000/-2500ppm/°C	-55 to 125°C	-	-	-	-	-	-
			20 to 85°C	-4700+500/-1000ppm/°C		-	-	-	-	-	-
X7S	EIA	25°C	-55 to 125°C	±22%	-55 to 125°C	-	-	-	-	-	-
X7T	EIA	25°C	-55 to 125°C	+22%, -33%	-55 to 125°C	-	-	-	-	-	-
X8L	*1	25°C	-55 to 150°C	+15%, -40%	-55 to 150°C	-	-	-	-	-	-
X7R	EIA	25°C	-55 to 125°C	±15%	-55 to 125°C	-	-	-	-	-	-
X8R	EIA	25°C	-55 to 150°C	±15%	-55 to 150°C	-	-	-	-	-	-

\*1 Murata Temperature Characteristic Code.

\*2 Rated Voltage 100Vdc max: 25 to 85°C

\*3 -25°C (Reference Temperature 20°C) / -30°C (Reference Temperature 25°C)

# Capacitance Table

p00

Each number in the Part Number List refers to the page number printed at the bottom of the page.

## ■ GCM Series Temperature Compensating Type

p00 ← Part Number List

EIA: C0G U2J

Murata Temperature Characteristic: ZLM

LxW (mm)	0.6x0.3	1.0x0.5	1.6x0.8		2.0x1.25						3.2x1.6						3.2x2.5											
	T max. (mm)	0.33	0.55	0.9	0.7	0.95	1.0	1.4	1.45	0.95	1.0	1.25			1.8	1.0	1.25											
Rated Voltage (Vdc)	25	50	100	50	100	50	100	50	250	50	250	100	80	63	50	1000	630	250	1000	630	250	50	1000	630	630	1000		
Cap. / TC Code	C0G	C0G	C0G	C0G	C0G	C0G	ZLM	C0G	U2J	C0G	U2J	C0G	C0G	C0G	C0G	U2J	U2J	U2J	U2J	U2J	U2J	C0G	U2J	U2J	U2J	U2J		
1.0pF	p17	p17	p17	p17																								
2.0pF	p17	p17	p17	p17																								
3.0pF	p17	p17	p17	p17																								
4.0pF	p17	p17	p17	p17																								
5.0pF	p17	p17	p17	p17																								
6.0pF	p17	p17	p17	p17																								
7.0pF	p17	p17	p17	p17																								
8.0pF	p17	p17	p17	p17																								
9.0pF	p17	p17	p17	p18																								
10pF	p17	p17	p17	p18												p19	p19											
12pF	p17	p17	p17	p18												p19	p19											
15pF	p17	p17	p17	p18												p19	p19											
18pF	p17	p17	p17	p18												p19	p19											
22pF	p17	p17	p17	p18												p19	p19											
27pF	p17	p17	p17	p18												p19	p19											
33pF	p17	p17	p17	p18												p19	p19											
39pF	p17	p17	p17	p18												p19	p19											
47pF	p17	p17	p17	p18												p19	p19											
56pF	p17	p17	p17	p18												p19	p19											
68pF	p17	p17	p17	p18												p19	p19											
82pF	p17	p17	p17	p18												p19	p19											
100pF	p17	p17	p17	p18	p18						p18					p19	p19											
120pF		p17	p17	p18	p18						p18					p19	p19											
150pF		p17	p17	p18	p18						p18					p19	p19											
180pF		p17	p17	p18	p18						p18					p19	p19											
220pF		p17	p17	p18	p18						p18					p19	p19											
270pF		p17	p17	p18	p18						p18					p19	p19											
330pF		p17	p17	p18	p18						p18					p19	p19											
390pF		p17	p17	p18	p18						p18					p19	p19		p19									
470pF		p17	p17	p18	p18						p18					p19	p19		p19									
560pF			p17	p18	p18						p18					p19	p19		p19									
680pF			p17	p18	p18						p18					p19	p19		p19									
820pF			p17	p18	p18						p18					p19	p19						p19					
1000pF			p17	p18	p18	p18	p18	p18			p18					p19	p19						p19					
1100pF											p18																	
1200pF			p17	p18	p18	p18	p18	p18			p18					p19	p19									p19	p19	
1300pF											p18																	
1500pF			p17	p18	p18	p18	p18	p18			p18					p19	p19										p19	
1800pF				p18	p18	p18					p18					p19	p19										p19	
2200pF				p18	p18	p18					p18					p19	p19										p19	
2700pF				p18	p18	p18					p18	p19				p19	p19		p19		p19							
3300pF				p18	p18	p18					p18	p19				p19	p19		p19		p19							
3900pF				p18		p18					p18	p19				p19	p19		p19		p19					p19		
4700pF						p18					p18	p19				p19	p19		p19		p19					p19		
5600pF							p18				p18	p19				p19	p19		p19		p19							
6800pF								p18				p19				p19	p19				p19							
8200pF									p18			p19				p19	p19				p19							
10000pF										p18			p19			p19	p19				p19							
12000pF											p18					p19	p19				p19							
15000pF												p18				p19	p19				p19							
18000pF													p18				p19	p19				p19						
22000pF														p18				p19	p19									
27000pF																												
33000pF																												
39000pF																												
47000pF																												
56000pF																												





# Capacitance Table p00 Each number in the Part Number List refers to the page number printed at the bottom of the page.

(→ ■ GCM Series Temperature Compensating Type)

p00 ← Part Number List    EIA: C0G U2J    Murata Temperature Characteristic: ZLM

3.2x2.5			4.5x3.2				5.7x5.0				LxW (mm)		
1.25	1.5	2.0	1.5	2.0	1.5	2.0	1.5	2.0	1.5	2.0	1.5	2.0	T max. (mm)
630	1000	630	1000	630	1000	630	1000	630	1000	630	1000	630	Rated Voltage (Vdc)
U2J	U2J	U2J	U2J	U2J	U2J	U2J	U2J	U2J	U2J	U2J	U2J	U2J	Cap. / TC Code
													1.0pF
													2.0pF
													3.0pF
													4.0pF
													5.0pF
													6.0pF
													7.0pF
													8.0pF
													9.0pF
													10pF
													12pF
													15pF
													18pF
													22pF
													27pF
													33pF
													39pF
													47pF
													56pF
													68pF
													82pF
													100pF
													120pF
													150pF
													180pF
													220pF
													270pF
													330pF
													390pF
													470pF
													560pF
													680pF
													820pF
													1000pF
													1100pF
													1200pF
													1300pF
	<span style="border: 1px solid black; padding: 2px;">p19</span>												1500pF
													1800pF
													2200pF
													2700pF
													3300pF
													3900pF
													4700pF
													5600pF
<span style="border: 1px solid black; padding: 2px;">p19</span>													6800pF
													8200pF
													10000pF
													12000pF
													15000pF
													18000pF
													22000pF
													27000pF
													33000pF
													39000pF
													47000pF
													56000pF

# Capacitance Table p00 Each number in the Part Number List refers to the page number printed at the bottom of the page.

## ■ GCM Series High Dielectric Constant Type

p00 ← Part Number List    EIA: X7S X7R

LxW (mm)	0.6x0.3			1.0x0.5				1.6x0.8					2.0x1.25								3.2x1.6						
T max. (mm)	0.33			0.55				0.9					0.7	0.95				1.4				0.95	1.25				
Rated Voltage (Vdc)	25	16	10	100	50	25	16	100	50	25	16	6.3	100	100	50	25	16	100	50	35	25	16	10	6.3	100	100	
Cap. / TC Code	X7R	X7R	X7R	X7R	X7R	X7R	X7R	X7R	X7R	X7R	X7R	X7R	X7R	X7R	X7R	X7R	X7R	X7R	X7R	X7R	X7R	X7R	X7R	X7R	X7R	X7R	X7R
100pF	p21																										
150pF	p21																										
220pF	p21			p21	p21																						
330pF	p21			p21	p21																						
470pF	p21			p21	p21																						
680pF	p21			p21	p21																						
1000pF	p21			p21	p21			p21	p21																		
1500pF	p21			p21	p21			p21	p21																		
2200pF		p21		p21	p21			p21	p21																		
3300pF		p21		p21	p21			p21	p21																		
4700pF			p21	p21	p21			p21	p21																		
6800pF			p21		p21			p21	p21				p21														
10000pF			p21		p21	p21		p21	p21				p21														
15000pF					p21	p21		p21	p21				p21														
22000pF					p21	p21		p21	p21				p21														
33000pF					p21	p21	p21		p21	p21				p22	p22												
47000pF					p21	p21	p21		p21	p21								p22	p22								
68000pF					p21		p21		p21	p21								p22	p22								
0.10μF					p21		p21		p21	p21	p21							p22	p22							p22	
0.15μF						p21		p21	p21	p21								p22	p22			p22					p22
0.22μF						p21		p21	p21									p22	p22			p22					p22
0.33μF											p21					p22					p22						
0.47μF										p21	p21					p22				p22							
0.68μF																	p22			p22	p22						
1.0μF										p21	p21						p22			p22	p22	p22					
1.5μF																			p22								
2.2μF												p21								p22	p22	p22					
4.7μF																						p22	p22				
10μF																							p22	p22			
22μF																											
47μF																											



# Capacitance Table p00 Each number in the Part Number List refers to the page number printed at the bottom of the page.

(→ ■ GCM Series High Dielectric Constant Type)

p00 ← Part Number List    EIA: X7S X7R

3.2x1.6									3.2x2.5									LxW (mm)
1.25	1.3	1.8						1.9	2.2	2.7						T max. (mm)		
50	25	100	50	25	16	10	6.3	25	25	16	50	35	25	16	10	6.3	Rated Voltage (Vdc)	
X7R	X7R	X7R	X7Δ	X7R	X7R	X7R	X7R	X7S	X7R	X7R	X7Δ	X7S	X7R	X7R	X7R	X7R	Cap. / TC Code	
																	100pF	
																	150pF	
																	220pF	
																	330pF	
																	470pF	
																	680pF	
																	1000pF	
																	1500pF	
																	2200pF	
																	3300pF	
																	4700pF	
																	6800pF	
																	10000pF	
																	15000pF	
																	22000pF	
																	33000pF	
																	47000pF	
																	68000pF	
																	0.10μF	
																	0.15μF	
																	0.22μF	
																	0.33μF	
																	0.47μF	
																	0.68μF	
																	1.0μF	
																	1.5μF	
																	2.2μF	
																	4.7μF	
																	10μF	
																	22μF	
																	47μF	

# Capacitance Table

p00

Each number in the Part Number List refers to the page number printed at the bottom of the page.

## ■ GCD Series High Dielectric Constant Type

p00 ← Part Number List EIA: X7R

LxW (mm)	1.6x0.8			2.0x1.25				
	T max. (mm)			T max. (mm)				
	0.9			0.7		0.95	1.4	
Rated Voltage (Vdc)	100	50	25	100	50	100	100	50
Cap. / TC Code	X7R	X7R	X7R	X7R	X7R	X7R	X7R	X7R
1000pF	p24	p24		p24	p24			
1200pF	p24	p24		p24	p24			
1500pF	p24	p24		p24	p24			
1800pF	p24	p24		p24	p24			
2200pF	p24	p24		p24	p24			
2700pF	p24	p24		p24	p24			
3300pF	p24	p24		p24	p24			
3900pF	p24	p24		p24	p24			
4700pF	p24	p24		p24	p24			
5600pF	p24	p24		p24	p24			
6800pF	p24	p24				p24		
8200pF	p24	p24					p24	
10000pF	p24	p24					p24	
12000pF	p24	p24					p24	
15000pF	p24	p24					p24	p24
18000pF	p24	p24					p24	p24
22000pF	p24	p24					p24	p24
27000pF			p24				p24	p24
33000pF			p24				p24	p24
39000pF			p24				p24	p24
47000pF			p24				p24	p24
56000pF							p24	p24
68000pF							p24	p24
82000pF							p24	p24
0.10μF							p24	p24

## ■ GCE Series High Dielectric Constant Type

p00 ← Part Number List EIA: X7R

LxW (mm)	1.6x0.8			2.0x1.25				
	T max. (mm)			T max. (mm)				
	0.9			0.7		0.95	1.45	
Rated Voltage (Vdc)	100	50	100	50	100	100	100	50
Cap. / TC Code	X7R	X7R	X7R	X7R	X7R	X7R	X7R	X7R
1000pF	p26	p26	p26	p26				
1200pF	p26	p26	p26	p26				
1500pF	p26	p26	p26	p26				
1800pF	p26	p26	p26	p26				
2200pF	p26	p26	p26	p26				
2700pF	p26	p26	p26	p26				
3300pF	p26	p26	p26	p26				
3900pF	p26	p26	p26	p26				
4700pF	p26	p26	p26	p26				
5600pF	p26	p26	p26	p26				
6800pF	p26	p26				p26		
8200pF	p26	p26					p26	
10000pF	p26	p26					p26	
12000pF	p26	p26					p26	
15000pF	p26	p26					p26	p26
18000pF	p26	p26					p26	p26
22000pF	p26	p26					p26	p26
27000pF							p26	p26
33000pF							p26	p26
39000pF							p26	p26
47000pF							p26	p26
56000pF							p26	p26
68000pF							p26	p26
82000pF							p26	p26
0.10μF							p26	p26

# Capacitance Table

p00

Each number in the Part Number List refers to the page number printed at the bottom of the page.

## ■ GCG Series

### Temperature Compensating Type

p00 ← Part Number List

Murata Temperature Characteristic: X8G

LxW (mm)	1.0x0.5		1.6x0.8		2.0x1.25	
	0.55	0.9	0.7	0.95		
T max. (mm)	0.55	0.9	0.7	0.95		
Rated Voltage (Vdc)	50	50	50	50		
Cap. / TC Code	X8G	X8G	X8G	X8G		
10pF		p28				
12pF		p28				
15pF		p28				
18pF		p28				
22pF		p28				
27pF		p28				
33pF		p28				
39pF		p28				
47pF		p28				
56pF		p28				
68pF		p28				
82pF		p28				
100pF		p28	p28			
120pF	p28	p28	p28			
150pF	p28	p28	p28			
180pF	p28	p28	p28			
220pF	p28	p28	p28			
270pF	p28	p28	p28			
330pF	p28	p28	p28			
390pF	p28	p28	p28			
470pF	p28	p28	p28			
560pF		p28	p28			
680pF		p28	p28			
820pF		p28	p28			
1000pF		p28	p28			
1200pF		p28	p28			
1500pF		p28	p28			
1800pF		p28	p28			
2200pF		p28	p28			
2700pF			p28			
3300pF			p28			
3900pF			p28			
4700pF			p28			
5600pF						p28
6800pF						p28
8200pF						p28
10000pF						p28

### High Dielectric Constant Type

EIA: X7R X8R

Murata Temperature Characteristic: X8L

LxW (mm)	1.0x0.5					1.6x0.8					2.0x1.25			
	0.55					0.9					0.95			
T max. (mm)	0.55					0.9					0.95			
Rated Voltage (Vdc)	50	25	16	100	50	25	16	50	25					
Cap. / TC Code	X7R	X8L	X7R	X8L	X7R	X8R	X8L	X8R	X7R	X8R	X7R	X8L	X8R	X8R
220pF	p29						p29							
270pF	p29						p29							
330pF	p29						p29							
390pF	p29						p29							
470pF	p29						p29							
560pF	p29						p29							
680pF	p29						p29							
820pF	p29						p29							
1000pF	p29						p29	p29			p30			
1200pF	p29						p29	p29	p29		p30			
1500pF	p29						p29	p29	p29		p30			
1800pF	p29						p29	p29			p30			
2200pF	p29						p29	p29			p30			
2700pF	p29						p29	p29	p29		p30			
3300pF	p29						p29	p29	p29		p30			
3900pF	p29						p29	p29	p29		p30			
4700pF	p29						p29	p29	p29		p30			
5600pF		p29	p29				p29	p29	p29		p30			
6800pF		p29	p29				p29	p29	p29		p30			
8200pF		p29	p29				p29	p29	p29		p30			
10000pF		p29	p29				p29	p29	p30		p30			p30 p30
12000pF							p29	p29						
15000pF			p29	p29			p29	p29	p30		p30			p30 p30
18000pF			p29	p29			p29	p29						p30
22000pF			p29	p29			p29	p29	p30		p30			p30 p30
27000pF			p29	p29			p29	p29		p30				
33000pF			p29	p29			p29	p29		p30	p30			
39000pF			p29	p29			p29	p29		p30				
47000pF			p29	p29			p29	p29		p30	p30			
56000pF				p29	p29					p30				
68000pF				p29	p29					p30	p30			p30
82000pF				p29						p30				
0.10μF				p29						p30				p30
0.12μF										p30				
0.15μF										p30			p30	
0.18μF										p30			p30	
0.22μF										p30			p30	
0.27μF														
0.33μF											p30			
0.39μF											p30			
0.47μF											p30			
0.56μF														
0.68μF														
0.82μF														
1.0μF														
1.2μF														
1.5μF														
2.2μF														
3.3μF														
3.9μF														
4.7μF														
10μF														



# Capacitance Table

p00

Each number in the Part Number List refers to the page number printed at the bottom of the page.

(→ ■ GCG Series High Dielectric Constant Type)

p00 ← Part Number List

EIA: X7R X8R Murata Temperature Characteristic: X8L

LxW (mm)	2.0x1.25						3.2x1.6						3.2x2.5		
	1.45						1.35			1.9			2.3	2.8	
T max. (mm)	1.45						1.35			1.9			2.3	2.8	
Rated Voltage (Vdc)	50		25		16		50	25	16	25	16	25	25		
Cap. / TC Code	X8L	X8R	X7R	X8L	X8R	X7R	X8L	X7R	X8R	X8R	X7R	X8L	X8R	X7R	X7R
220pF															
270pF															
330pF															
390pF															
470pF															
560pF															
680pF															
820pF															
1000pF															
1200pF															
1500pF															
1800pF															
2200pF															
2700pF															
3300pF															
3900pF															
4700pF															
5600pF															
6800pF															
8200pF															
10000pF															
12000pF															
15000pF															
18000pF															
22000pF															
27000pF	p30														
33000pF	p30	p30			p30										
39000pF	p30				p30										
47000pF	p30	p30			p30										
56000pF		p30													
68000pF		p30													
82000pF					p30										
0.10μF	p30	p30		p30	p30										
0.12μF															
0.15μF			p30		p30			p30	p30						
0.18μF			p30		p30										
0.22μF			p30		p30			p30	p30						
0.27μF						p30									
0.33μF			p30		p30	p30		p30	p30						
0.39μF					p30	p30									
0.47μF					p30	p30									
0.56μF					p30	p30									
0.68μF					p30	p30					p31			p31	
0.82μF					p30	p30									
1.0μF					p30				p30	p31				p31	
1.2μF									p31						
1.5μF									p31	p31					
2.2μF									p31						
3.3μF												p31	p31		p31
3.9μF												p31			
4.7μF								p30				p31	p31		p31
10μF															p31

# Capacitance Table

p00

Each number in the Part Number List refers to the page number printed at the bottom of the page.

## GCJ Series High Dielectric Constant Type

p00 ← Part Number List

EIA: X7S X7R X8R

Murata Temperature Characteristic: X8L

LxW (mm)	1.6x0.8											2.0x1.25																	
T max. (mm)	0.9											0.7			0.95			1.0		1.45									
Rated Voltage (Vdc)	100		50			35		25			16		10		6.3		100	50	25	100	50	25	16	250	250	100	50	35	
Cap. / TC Code	X8R	X7R	X8L	X8R	X7R	X8L	X8L	X8R	X7R	X8L	X7R	X7R	X7R	X7R	X7R	X7R	X7R	X7R	X7R	X7R	X7R	X7R	X7R	X7R	X7R	X7R	X8L	X7R	X8L
220pF																													
270pF																													
330pF																													
390pF																													
470pF																													
560pF																													
680pF																													
820pF																													
1000pF	p33	p33	p33		p33																								
1200pF	p33	p33	p33		p33																								
1500pF	p33	p33	p33		p33																								
1800pF	p33	p33	p33		p33																								
2200pF	p33	p33	p33		p33																								
2700pF	p33	p33	p33		p33																								
3300pF	p33	p33	p33		p33																								
3900pF	p33	p33	p33		p33																								
4700pF	p33	p33	p33	p33	p33																								
5600pF	p33	p33	p33		p33																								
6800pF	p33	p33	p33		p33																								
8200pF	p33	p33	p33		p33																								
10000pF	p33	p33	p33	p33	p33							p34																	
12000pF	p33	p33	p33		p33																								
15000pF	p33	p33	p33		p33																								
18000pF	p33	p33	p33		p33																								
22000pF	p33	p33	p33		p33																								
27000pF	p33																												
33000pF	p33					p33	p33	p33																					
39000pF	p33					p33	p33	p33																					
47000pF	p33					p33																							
56000pF	p33					p33	p33	p33																					
68000pF	p33					p33	p33	p33																					
82000pF						p33		p33																					
0.10μF		p33		p33	p33																								
0.12μF				p33																									
0.15μF				p33	p33		p33																						
0.18μF				p33			p33																						
0.22μF				p33	p33		p33																						
0.27μF																													
0.33μF									p33																				
0.39μF									p33																				
0.47μF									p33																				
0.56μF																													
0.68μF																													
0.82μF																													
1.0μF																													
1.5μF																													
2.2μF																													
3.3μF																													
4.7μF																													
6.8μF																													
10μF																													
22μF																													
47μF																													



# Capacitance Table

p00

Each number in the Part Number List refers to the page number printed at the bottom of the page.

(→ ■ GCJ Series High Dielectric Constant Type)

p00 ← Part Number List

EIA: X7S X7R X8R

Murata Temperature Characteristic: X8L

LxW (mm)	2.0x1.25										3.2x1.6													
	1.45					0.95		1.25			1.35		1.8			1.9								
T max. (mm)	1.45					0.95		1.25			1.35		1.8			1.9								
Rated Voltage (Vdc)	25	16	10	100	50	100	50	1000	630	250	100	50	25	16	1000	630	250	100	50	35	25	16	10	6.3
Cap. / TC Code	X8L	X7R	X8L	X7R	X7R	X7R	X7R	X7R	X7R	X7R	X7R	X7R	X7R	X7R	X7R	X7R	X7R	X7R	X7R	X7R	X7R	X7R	X7R	X7R
220pF																								
270pF																								
330pF																								
390pF																								
470pF																								
560pF																								
680pF																								
820pF																								
1000pF									p36	p36														
1200pF																								
1500pF									p36	p36														
1800pF																								
2200pF									p36	p36														
2700pF																								
3300pF									p36	p36														
3900pF																								
4700pF									p36	p36														
5600pF																								
6800pF									p36								p36							
8200pF																								
10000pF									p36								p36							
12000pF																								
15000pF										p36														
18000pF																								
22000pF										p36														
27000pF		p35																						
33000pF		p35																						
39000pF		p35																						
47000pF		p35																						
56000pF		p35																						
68000pF		p35								p36														
82000pF		p35																						
0.10μF		p35					p36	p36										p36						
0.12μF	p35							p36																
0.15μF	p35									p36	p36	p36												
0.18μF	p35									p36	p36	p36												
0.22μF	p35									p36	p36	p36												
0.27μF	p35	p35										p36												
0.33μF	p35												p36											
0.39μF	p35	p35												p36										
0.47μF	p35														p36									
0.56μF		p35	p35																					
0.68μF	p35	p35	p36																					
0.82μF	p35	p35	p36																					
1.0μF	p35	p35	p36	p36																				
1.5μF		p35																						
2.2μF		p35																						
3.3μF																								
4.7μF																								
6.8μF																								
10μF																								
22μF																								
47μF																								





# Capacitance Table

p00

Each number in the Part Number List refers to the page number printed at the bottom of the page.

(→ ■ GCJ Series High Dielectric Constant Type)

p00 ← Part Number List

EIA: X7S X7R X8R

Murata Temperature Characteristic: X8L

3.2x1.6	3.2x2.5											4.5x3.2					5.7x5.0			LxW (mm)
2.0	1.5		2.0		2.3		2.8			1.5		2.0			2.0			T max. (mm)		
25	630	250	1000	630	250	100	50	25	16	6.3	630	250	1000	630	250	1000	630	250	Rated Voltage (Vdc)	
X7S	X7R	X7R	X7R	X7R	X7R	X7R	X7Δ	X8L	X7R	X7R	X7R	X7R	X7R	X7R	X7R	X7R	X7R	X7R	X7R	Cap. / TC Code
																				220pF
																				270pF
																				330pF
																				390pF
																				470pF
																				560pF
																				680pF
																				820pF
																				1000pF
																				1200pF
																				1500pF
																				1800pF
																				2200pF
																				2700pF
																				3300pF
																				3900pF
																				4700pF
																				5600pF
																				6800pF
																				8200pF
																				10000pF
																				12000pF
																				15000pF
																				18000pF
																				22000pF
																				27000pF
																				33000pF
																				39000pF
																				47000pF
																				56000pF
																				68000pF
																				82000pF
																				0.10μF
																				0.12μF
																				0.15μF
																				0.18μF
																				0.22μF
																				0.27μF
																				0.33μF
																				0.39μF
																				0.47μF
																				0.56μF
																				0.68μF
																				0.82μF
																				1.0μF
																				1.5μF
																				2.2μF
																				3.3μF
																				4.7μF
																				6.8μF
																				10μF
																				22μF
																				47μF

# Capacitance Table

p00

Each number in the Part Number List refers to the page number printed at the bottom of the page.

## GC3 Series High Dielectric Constant Type

p00 ← Part Number List    EIA: X7T

LxW (mm)	2.0x1.25				3.2x1.6						3.2x2.5				4.5x3.2				5.7x5.0						
	T max. (mm)		1.0		1.0		1.25		1.8		1.5		2.0		1.5		2.0		2.0			2.7			
Rated Voltage (Vdc)	250	250	450	250	630	450	250	630	450	250	630	250	630	450	250	250	630	450	250	630	450	250	630	450	250
Cap. / TC Code	X7T	X7T	X7T	X7T	X7T	X7T	X7T	X7T	X7T	X7T	X7T	X7T	X7T	X7T	X7T	X7T	X7T	X7T	X7T	X7T	X7T	X7T	X7T	X7T	X7T
10000pF	p39		p39		p39																				
15000pF	p39		p39				p39																		
22000pF		p39			p39						p39														
33000pF			p39		p39							p39													
47000pF						p39		p39					p39												
68000pF									p39					p39			p39								
0.10μF										p39				p39					p39						
0.15μF														p39			p39			p39					
0.22μF															p39					p39		p39			
0.27μF																		p39					p39		
0.33μF																		p39		p39					
0.47μF																			p39	p39					
0.56μF																								p39	
0.68μF																						p39			
1.0μF																									p39

## KCM Series High Dielectric Constant Type

p00 ← Part Number List    EIA: X7R

LxW (mm)	6.1x5.3																								
	3.0					3.9					5.0					6.7									
T max. (mm)	100					63					50					35					25				
Rated Voltage (Vdc)	100	63	50	35	25	100	63	50	35	25	100	50	35	25	100	63	50	35	25	100	63	50	35	25	
Cap. / TC Code	X7R	X7R	X7R	X7R	X7R	X7R	X7R	X7R	X7R	X7R	X7R	X7R	X7R	X7R	X7R	X7R	X7R	X7R	X7R	X7R	X7R	X7R	X7R	X7R	
4.7μF	p42	p42	p42																						
6.8μF					p42																				
10μF			p42	p42			p42						p42												
15μF				p42	p42													p42							
17μF								p42	p42																
22μF									p42	p42			p42	p42				p42							
33μF										p42				p42	p42										
47μF																					p42	p42			
68μF																								p42	

## KC3 Series High Dielectric Constant Type

p00 ← Part Number List    EIA: X7T

LxW (mm)	6.1x5.3																	
	3.0			3.9			5.0			6.7								
T max. (mm)	630			450			250			630			450			250		
Rated Voltage (Vdc)	630	450	250	630	450	250	450	250	630	450	250	630	450	250	630	450	250	
Cap. / TC Code	X7T	X7T	X7T	X7T	X7T	X7T	X7T	X7T	X7T	X7T	X7T	X7T	X7T	X7T	X7T	X7T	X7T	
0.10μF	p45																	
0.15μF	p45																	
0.22μF		p45		p45														
0.27μF			p45															
0.33μF		p45																
0.47μF		p45	p45								p45							
0.56μF				p45								p45						
0.68μF			p45								p45	p45						
1.0μF						p45	p45											
1.2μF															p45			
1.5μF											p45							
2.2μF																	p45	

# Search Capacitors

Specifications and Test Methods, Package, Chart of Characteristic Data, please refer to the search web page.  
<http://www.murata.com/products/capacitor/>



## Data Sheet

The product details page can be output in PDF.

## Status and Features Icons

The status and features of products can be checked at once. When ? is clicked, a description of each icon will be displayed.

## Characteristics & Applications

This links to the introduction page of each series.

## Detailed Specifications Sheet

- Rated value
- Specifications and Test Methods
- Package
- Caution, Notice (Storage, Soldering and Mounting, ....etc.)

## Characteristics Data

The following characteristics data of the main products can be acquired.

- SPICE Netlist (mod type)
- S parameter (S2P type)
- Reliability Test Data \*Typical data

- Shape (Dimensions)
- Rated Values

- Specification by Packaging Code/ Minimum Order Quantity
- Weight (1 pc/ø180mm reel)

## Chart of Characteristic Data

The main products published characteristic data.

- Frequency characteristics (ESR, Impedance)
- S parameter (Smith chart S11)
- DC bias characteristics
- AC voltage characteristics
- Capacitance - temperature characteristics
- Calorific property by ripple current

## Design Tools SimSurfing

The SimSurfing design tools are useful for displaying the graph, downloading CSV data and overwriting the product number graph.

General Purpose Product

# GCM Series



Capacitor for automotive applications such as power train and safety equipment.

## Features

### 1 Ideal for power trains and safety devices in automobiles.

This product can be used for safety devices, such as the drive system control for engine ECU, air bags, and ABS. This product has cleared test conditions more severe than that of general products (GRM Series) even in temperature cycle and humidity load tests.

	General Purpose GRM Series Maximum operating temperature: <b>85°C/105°C/125°C</b>	GCM Series for Automobiles Maximum operating temperature: <b>125°C</b>
Items	Test Method	Test Method
Temperature Cycle	Temperature Cycle: <b>5 cycles</b>	Temperature Cycle: <b>100 cycles</b> <b>(1,000 cycles for AEC-Q200 conforming products)</b>
Humidity Loading	Test temperature: <b>40±2°C</b> Test humidity: <b>90 to 95%RH</b> Test time: 500 hours	Test temperature: <b>85±2°C</b> Test humidity: <b>80 to 85%RH</b> Test time: 500 hours <b>(1,000 hours for AEC-Q200 conforming products)</b>

### 2 Can be used at 125°C and 150°C temperatures.

We also offer a lineup for 150°C that can be used in the engine room.

### 3 Sn plating is applied to the external electrodes; excellent solder ability.

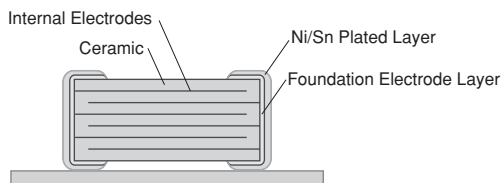

<Example of Structure>

## Specifications

Size	0.6×0.3mm to 5.7×5.0mm
Rated Voltage	6.3Vdc to 1kVdc
Capacitance	0.1pF to 47μF
Main Applications	Drive system control of engine ECU, Airbag, Safety equipment such as ABS

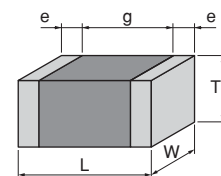

<Dimensions>

# GCM Series Temperature Compensating Type AEC Q200 Part Number List

## ■ 0.6×0.3mm Ultra-compact

T max.	Rated Voltage	TC Code	Cap.	Tol.	Part Number
0.33mm	25Vdc	COG	1.0pF	±0.25pF	GCM0335C1E1R0CD03#
			2.0pF	±0.25pF	GCM0335C1E2R0CD03#
			3.0pF	±0.25pF	GCM0335C1E3R0CD03#
			4.0pF	±0.25pF	GCM0335C1E4R0CD03#
			5.0pF	±0.25pF	GCM0335C1E5R0CD03#
			6.0pF	±0.5pF	GCM0335C1E6R0DD03#
			7.0pF	±0.5pF	GCM0335C1E7R0DD03#
			8.0pF	±0.5pF	GCM0335C1E8R0DD03#
			9.0pF	±0.5pF	GCM0335C1E9R0DD03#
			10pF	±5%	GCM0335C1E100JD03#
			12pF	±5%	GCM0335C1E120JD03#
			15pF	±5%	GCM0335C1E150JD03#
			18pF	±5%	GCM0335C1E180JD03#
			22pF	±5%	GCM0335C1E220JD03#
			27pF	±5%	GCM0335C1E270JD03#
			33pF	±5%	GCM0335C1E330JD03#
			39pF	±5%	GCM0335C1E390JD03#
			47pF	±5%	GCM0335C1E470JD03#
			56pF	±5%	GCM0335C1E560JD03#
			68pF	±5%	GCM0335C1E680JD03#
82pF	±5%	GCM0335C1E820JD03#			
100pF	±5%	GCM0335C1E101JD03#			

## ■ 1.0×0.5mm

T max.	Rated Voltage	TC Code	Cap.	Tol.	Part Number
0.55mm	50Vdc	COG	1.0pF	±0.25pF	GCM1555C1H1R0CA16#
			2.0pF	±0.25pF	GCM1555C1H2R0CA16#
			3.0pF	±0.25pF	GCM1555C1H3R0CA16#
			4.0pF	±0.25pF	GCM1555C1H4R0CA16#
			5.0pF	±0.25pF	GCM1555C1H5R0CA16#
			6.0pF	±0.5pF	GCM1555C1H6R0DA16#
			7.0pF	±0.5pF	GCM1555C1H7R0DA16#
			8.0pF	±0.5pF	GCM1555C1H8R0DA16#
			9.0pF	±0.5pF	GCM1555C1H9R0DA16#
			10pF	±5%	GCM1555C1H100JA16#
			12pF	±5%	GCM1555C1H120JA16#
			15pF	±5%	GCM1555C1H150JA16#
			18pF	±5%	GCM1555C1H180JA16#
			22pF	±5%	GCM1555C1H220JA16#
			27pF	±5%	GCM1555C1H270JA16#
			33pF	±5%	GCM1555C1H330JA16#
			39pF	±5%	GCM1555C1H390JA16#
			47pF	±5%	GCM1555C1H470JA16#
			56pF	±5%	GCM1555C1H560JA16#
			68pF	±5%	GCM1555C1H680JA16#
82pF	±5%	GCM1555C1H820JA16#			
100pF	±5%	GCM1555C1H101JA16#			
120pF	±5%	GCM1555C1H121JA16#			
150pF	±5%	GCM1555C1H151JA16#			
180pF	±5%	GCM1555C1H181JA16#			

T max.	Rated Voltage	TC Code	Cap.	Tol.	Part Number
0.55mm	50Vdc	COG	220pF	±5%	GCM1555C1H221JA16#
			270pF	±5%	GCM1555C1H271JA16#
			330pF	±5%	GCM1555C1H331JA16#
			390pF	±5%	GCM1555C1H391JA16#
			470pF	±5%	GCM1555C1H471JA16#

## ■ 1.6×0.8mm

T max.	Rated Voltage	TC Code	Cap.	Tol.	Part Number
0.9mm	100Vdc	COG	1.0pF	±0.25pF	GCM1885C2A1R0CA16#
			2.0pF	±0.25pF	GCM1885C2A2R0CA16#
			3.0pF	±0.25pF	GCM1885C2A3R0CA16#
			4.0pF	±0.25pF	GCM1885C2A4R0CA16#
			5.0pF	±0.25pF	GCM1885C2A5R0CA16#
			6.0pF	±0.5pF	GCM1885C2A6R0DA16#
			7.0pF	±0.5pF	GCM1885C2A7R0DA16#
			8.0pF	±0.5pF	GCM1885C2A8R0DA16#
			9.0pF	±0.5pF	GCM1885C2A9R0DA16#
			10pF	±5%	GCM1885C2A100JA16#
			12pF	±5%	GCM1885C2A120JA16#
			15pF	±5%	GCM1885C2A150JA16#
			18pF	±5%	GCM1885C2A180JA16#
			22pF	±5%	GCM1885C2A220JA16#
			27pF	±5%	GCM1885C2A270JA16#
			33pF	±5%	GCM1885C2A330JA16#
			39pF	±5%	GCM1885C2A390JA16#
			47pF	±5%	GCM1885C2A470JA16#
			56pF	±5%	GCM1885C2A560JA16#
			68pF	±5%	GCM1885C2A680JA16#
			82pF	±5%	GCM1885C2A820JA16#
			100pF	±5%	GCM1885C2A101JA16#
			120pF	±5%	GCM1885C2A121JA16#
			150pF	±5%	GCM1885C2A151JA16#
			180pF	±5%	GCM1885C2A181JA16#
			220pF	±5%	GCM1885C2A221JA16#
			270pF	±5%	GCM1885C2A271JA16#
			330pF	±5%	GCM1885C2A331JA16#
			390pF	±5%	GCM1885C2A391JA16#
			470pF	±5%	GCM1885C2A471JA16#
560pF	±5%	GCM1885C2A561JA16#			
680pF	±5%	GCM1885C2A681JA16#			
820pF	±5%	GCM1885C2A821JA16#			
1000pF	±5%	GCM1885C2A102JA16#			
1200pF	±5%	GCM1885C2A122JA16#			
1500pF	±5%	GCM1885C2A152JA16#			
	50Vdc	COG	1.0pF	±0.25pF	GCM1885C1H1R0CA16#
			2.0pF	±0.25pF	GCM1885C1H2R0CA16#
			3.0pF	±0.25pF	GCM1885C1H3R0CA16#
			4.0pF	±0.25pF	GCM1885C1H4R0CA16#
			5.0pF	±0.25pF	GCM1885C1H5R0CA16#
			6.0pF	±0.5pF	GCM1885C1H6R0DA16#
			7.0pF	±0.5pF	GCM1885C1H7R0DA16#
			8.0pF	±0.5pF	GCM1885C1H8R0DA16#

Part number # indicates the package specification code.

# GCM Series Temperature Compensating Type AEC Q200 Part Number List

(→ ■ 1.6x0.8mm)

T max.	Rated Voltage	TC Code	Cap.	Tol.	Part Number
0.9mm	50Vdc	C0G	9.0pF	±0.5pF	<b>GCM1885C1H9R0DA16#</b>
			10pF	±5%	<b>GCM1885C1H100JA16#</b>
			12pF	±5%	<b>GCM1885C1H120JA16#</b>
			15pF	±5%	<b>GCM1885C1H150JA16#</b>
			18pF	±5%	<b>GCM1885C1H180JA16#</b>
			22pF	±5%	<b>GCM1885C1H220JA16#</b>
			27pF	±5%	<b>GCM1885C1H270JA16#</b>
			33pF	±5%	<b>GCM1885C1H330JA16#</b>
			39pF	±5%	<b>GCM1885C1H390JA16#</b>
			47pF	±5%	<b>GCM1885C1H470JA16#</b>
			56pF	±5%	<b>GCM1885C1H560JA16#</b>
			68pF	±5%	<b>GCM1885C1H680JA16#</b>
			82pF	±5%	<b>GCM1885C1H820JA16#</b>
			100pF	±5%	<b>GCM1885C1H101JA16#</b>
			120pF	±5%	<b>GCM1885C1H121JA16#</b>
			150pF	±5%	<b>GCM1885C1H151JA16#</b>
			180pF	±5%	<b>GCM1885C1H181JA16#</b>
			220pF	±5%	<b>GCM1885C1H221JA16#</b>
			270pF	±5%	<b>GCM1885C1H271JA16#</b>
			330pF	±5%	<b>GCM1885C1H331JA16#</b>
			390pF	±5%	<b>GCM1885C1H391JA16#</b>
			470pF	±5%	<b>GCM1885C1H471JA16#</b>
			560pF	±5%	<b>GCM1885C1H561JA16#</b>
			680pF	±5%	<b>GCM1885C1H681JA16#</b>
			820pF	±5%	<b>GCM1885C1H821JA16#</b>
			1000pF	±5%	<b>GCM1885C1H102JA16#</b>
			1200pF	±5%	<b>GCM1885C1H122JA16#</b>
			1500pF	±5%	<b>GCM1885C1H152JA16#</b>
			1800pF	±5%	<b>GCM1885C1H182JA16#</b>
			2200pF	±5%	<b>GCM1885C1H222JA16#</b>
			2700pF	±5%	<b>GCM1885C1H272JA16#</b>
			3300pF	±5%	<b>GCM1885C1H332JA16#</b>
			3900pF	±5%	<b>GCM1885C1H392JA16#</b>

■ 2.0x1.25mm

T max.	Rated Voltage	TC Code	Cap.	Tol.	Part Number
0.7mm	100Vdc	C0G	100pF	±5%	<b>GCM2165C2A101JA16#</b>
			120pF	±5%	<b>GCM2165C2A121JA16#</b>
			150pF	±5%	<b>GCM2165C2A151JA16#</b>
			180pF	±5%	<b>GCM2165C2A181JA16#</b>
			220pF	±5%	<b>GCM2165C2A221JA16#</b>
			270pF	±5%	<b>GCM2165C2A271JA16#</b>
			330pF	±5%	<b>GCM2165C2A331JA16#</b>
			390pF	±5%	<b>GCM2165C2A391JA16#</b>
			470pF	±5%	<b>GCM2165C2A471JA16#</b>
			560pF	±5%	<b>GCM2165C2A561JA16#</b>
			680pF	±5%	<b>GCM2165C2A681JA16#</b>
			820pF	±5%	<b>GCM2165C2A821JA16#</b>
			1000pF	±5%	<b>GCM2165C2A102JA16#</b>
			1200pF	±5%	<b>GCM2165C2A122JA16#</b>
			1500pF	±5%	<b>GCM2165C2A152JA16#</b>
			1800pF	±5%	<b>GCM2165C2A182JA16#</b>

T max.	Rated Voltage	TC Code	Cap.	Tol.	Part Number		
0.7mm	100Vdc	C0G	2200pF	±5%	<b>GCM2165C2A222JA16#</b>		
			2700pF	±5%	<b>GCM2165C2A272JA16#</b>		
			3300pF	±5%	<b>GCM2165C2A332JA16#</b>		
			50Vdc	C0G	1000pF	±5%	<b>GCM2165C1H102JA16#</b>
					1200pF	±5%	<b>GCM2165C1H122JA16#</b>
					1500pF	±5%	<b>GCM2165C1H152JA16#</b>
	100Vdc	ZLM	1000pF	±10%	<b>GCM2199E2A102KA05#</b>		
				±20%	<b>GCM2199E2A102MA05#</b>		
				1100pF	±10%	<b>GCM2199E2A112KA05#</b>	
			1200pF	±10%	<b>GCM2199E2A112MA05#</b>		
				±20%	<b>GCM2199E2A112MA05#</b>		
				1200pF	±10%	<b>GCM2199E2A122KA05#</b>	
	50Vdc	C0G	5600pF	±5%	<b>GCM2195C1H562JA16#</b>		
				±5%	<b>GCM2195C1H682JA16#</b>		
				±5%	<b>GCM2195C1H822JA16#</b>		
			10000pF	±5%	<b>GCM2195C1H103JA16#</b>		
				±5%	<b>GCM2195C1H123JA16#</b>		
				±5%	<b>GCM2195C1H153JA16#</b>		
1.0mm	250Vdc	U2J	100pF	±5%	<b>GCM21A7U2E101JX01#</b>		
			120pF	±5%	<b>GCM21A7U2E121JX01#</b>		
			150pF	±5%	<b>GCM21A7U2E151JX01#</b>		
			180pF	±5%	<b>GCM21A7U2E181JX01#</b>		
			220pF	±5%	<b>GCM21A7U2E221JX01#</b>		
			270pF	±5%	<b>GCM21A7U2E271JX01#</b>		
			330pF	±5%	<b>GCM21A7U2E331JX01#</b>		
			390pF	±5%	<b>GCM21A7U2E391JX01#</b>		
			470pF	±5%	<b>GCM21A7U2E471JX01#</b>		
			560pF	±5%	<b>GCM21A7U2E561JX01#</b>		
			680pF	±5%	<b>GCM21A7U2E681JX01#</b>		
			820pF	±5%	<b>GCM21A7U2E821JX01#</b>		
			1000pF	±5%	<b>GCM21A7U2E102JX01#</b>		
			1200pF	±5%	<b>GCM21A7U2E122JX01#</b>		
			1500pF	±5%	<b>GCM21A7U2E152JX01#</b>		
			1800pF	±5%	<b>GCM21A7U2E182JX01#</b>		
			2200pF	±5%	<b>GCM21A7U2E222JX01#</b>		
			1.4mm	50Vdc	C0G	18000pF	±5%
22000pF	±5%	<b>GCM21B5C1H223JA16#</b>					
1.45mm	250Vdc	U2J	2700pF	±5%	<b>GCM21B7U2E272JX03#</b>		
			3300pF	±5%	<b>GCM21B7U2E332JX03#</b>		
			3900pF	±5%	<b>GCM21B7U2E392JX03#</b>		
			4700pF	±5%	<b>GCM21B7U2E472JX03#</b>		
			5600pF	±5%	<b>GCM21B7U2E562JX03#</b>		

Part number # indicates the package specification code.

# GCM Series Temperature Compensating Type AEC Q200 Part Number List

## ■ 3.2x1.6mm

T max.	Rated Voltage	TC Code	Cap.	Tol.	Part Number		
0.95mm	100Vdc	C0G	1800pF	±5%	GCM3195C2A182JA16#		
			2200pF	±5%	GCM3195C2A222JA16#		
			2700pF	±5%	GCM3195C2A272JA16#		
			3300pF	±5%	GCM3195C2A332JA16#		
			3900pF	±5%	GCM3195C2A392JA16#		
			4700pF	±5%	GCM3195C2A472JA16#		
			5600pF	±5%	GCM3195C2A562JA16#		
			6800pF	±5%	GCM3195C2A682JA16#		
			8200pF	±5%	GCM3195C2A822JA16#		
			10000pF	±5%	GCM3195C2A103JA16#		
			80Vdc	C0G	33000pF	±5%	GCM3195C1K333JA16#
	63Vdc	C0G	33000pF	±5%	GCM3195C1J333JA16#		
	50Vdc	C0G	3900pF	±5%	GCM3195C1H392JA16#		
			4700pF	±5%	GCM3195C1H472JA16#		
			5600pF	±5%	GCM3195C1H562JA16#		
			6800pF	±5%	GCM3195C1H682JA16#		
			8200pF	±5%	GCM3195C1H822JA16#		
			10000pF	±5%	GCM3195C1H103JA16#		
			12000pF	±5%	GCM3195C1H123JA16#		
			15000pF	±5%	GCM3195C1H153JA16#		
			18000pF	±5%	GCM3195C1H183JA16#		
			22000pF	±5%	GCM3195C1H223JA16#		
			27000pF	±5%	GCM3195C1H273JA16#		
	33000pF	±5%	GCM3195C1H333JA16#				
	39000pF	±5%	GCM3195C1H393JA16#				
	1.0mm	1000Vdc	U2J	10pF	±5%	GCM31A7U3A100JX01#	
				12pF	±5%	GCM31A7U3A120JX01#	
				15pF	±5%	GCM31A7U3A150JX01#	
				18pF	±5%	GCM31A7U3A180JX01#	
				22pF	±5%	GCM31A7U3A220JX01#	
				27pF	±5%	GCM31A7U3A270JX01#	
				33pF	±5%	GCM31A7U3A330JX01#	
				39pF	±5%	GCM31A7U3A390JX01#	
47pF				±5%	GCM31A7U3A470JX01#		
56pF				±5%	GCM31A7U3A560JX01#		
68pF				±5%	GCM31A7U3A680JX01#		
82pF				±5%	GCM31A7U3A820JX01#		
100pF				±5%	GCM31A7U3A101JX01#		
120pF				±5%	GCM31A7U3A121JX01#		
150pF				±5%	GCM31A7U3A151JX01#		
180pF				±5%	GCM31A7U3A181JX01#		
220pF				±5%	GCM31A7U3A221JX01#		
270pF				±5%	GCM31A7U3A271JX01#		
330pF				±5%	GCM31A7U3A331JX01#		
630Vdc				U2J	10pF	±5%	GCM31A7U2J100JX01#
					12pF	±5%	GCM31A7U2J120JX01#
					15pF	±5%	GCM31A7U2J150JX01#
					18pF	±5%	GCM31A7U2J180JX01#
					22pF	±5%	GCM31A7U2J220JX01#
	27pF	±5%	GCM31A7U2J270JX01#				
	33pF	±5%	GCM31A7U2J330JX01#				
	39pF	±5%	GCM31A7U2J390JX01#				

T max.	Rated Voltage	TC Code	Cap.	Tol.	Part Number			
1.0mm	630Vdc	U2J	47pF	±5%	GCM31A7U2J470JX01#			
			56pF	±5%	GCM31A7U2J560JX01#			
			68pF	±5%	GCM31A7U2J680JX01#			
			82pF	±5%	GCM31A7U2J820JX01#			
			100pF	±5%	GCM31A7U2J101JX01#			
			120pF	±5%	GCM31A7U2J121JX01#			
			150pF	±5%	GCM31A7U2J151JX01#			
			180pF	±5%	GCM31A7U2J181JX01#			
			220pF	±5%	GCM31A7U2J221JX01#			
			270pF	±5%	GCM31A7U2J271JX01#			
			330pF	±5%	GCM31A7U2J331JX01#			
			390pF	±5%	GCM31A7U2J391JX01#			
			470pF	±5%	GCM31A7U2J471JX01#			
			560pF	±5%	GCM31A7U2J561JX01#			
			680pF	±5%	GCM31A7U2J681JX01#			
			820pF	±5%	GCM31A7U2J821JX01#			
			1000pF	±5%	GCM31A7U2J102JX01#			
			1200pF	±5%	GCM31A7U2J122JX01#			
			1500pF	±5%	GCM31A7U2J152JX01#			
			1800pF	±5%	GCM31A7U2J182JX01#			
			2200pF	±5%	GCM31A7U2J222JX01#			
			250Vdc	U2J	2700pF	±5%	GCM31A7U2E272JX01#	
	3300pF	±5%			GCM31A7U2E332JX01#			
	3900pF	±5%			GCM31A7U2E392JX01#			
	4700pF	±5%			GCM31A7U2E472JX01#			
	5600pF	±5%			GCM31A7U2E562JX01#			
	1.25mm	1000Vdc			U2J	390pF	±5%	GCM31B7U3A391JX01#
						470pF	±5%	GCM31B7U3A471JX01#
						560pF	±5%	GCM31B7U3A561JX01#
						680pF	±5%	GCM31B7U3A681JX01#
		630Vdc			U2J	2700pF	±5%	GCM31B7U2J272JX01#
						3300pF	±5%	GCM31B7U2J332JX01#
			250Vdc	U2J		6800pF	±5%	GCM31B7U2E682JX01#
8200pF						±5%	GCM31B7U2E822JX01#	
10000pF	±5%	GCM31B7U2E103JX01#						
50Vdc	C0G	47000pF	±5%	GCM31M5C1H473JA16#				
		56000pF	±5%	GCM31M5C1H563JA16#				
1.8mm	1000Vdc	U2J	820pF	±5%	GCM31C7U3A821JX03#			
			1000pF	±5%	GCM31C7U3A102JX03#			
	630Vdc	U2J	3900pF	±5%	GCM31C7U2J392JX03#			
			4700pF	±5%	GCM31C7U2J472JX03#			

## ■ 3.2x2.5mm

T max.	Rated Voltage	TC Code	Cap.	Tol.	Part Number
1.0mm	630Vdc	U2J	1200pF	±5%	GCM32A7U2J122JX01#
			1500pF	±5%	GCM32A7U2J152JX01#
			1800pF	±5%	GCM32A7U2J182JX01#
			2200pF	±5%	GCM32A7U2J222JX01#
			1.25mm	1000Vdc	U2J
630Vdc	U2J	5600pF			
1.5mm	1000Vdc	U2J	1500pF	±5%	GCM32Q7U3A152JX01#
			630Vdc	U2J	6800pF

Part number # indicates the package specification code.

## GCM Series Temperature Compensating Type AEC Q200 Part Number List

(→ ■ 3.2×2.5mm)

T max.	Rated Voltage	TC Code	Cap.	Tol.	Part Number
2.0mm	1000Vdc	U2J	1800pF	±5%	<b>GCM32D7U3A182JX01#</b>
			2200pF	±5%	<b>GCM32D7U3A222JX01#</b>
	630Vdc	U2J	8200pF	±5%	<b>GCM32D7U2J822JX01#</b>
			10000pF	±5%	<b>GCM32D7U2J103JX01#</b>

■ 4.5×3.2mm

T max.	Rated Voltage	TC Code	Cap.	Tol.	Part Number
1.5mm	1000Vdc	U2J	2700pF	±5%	<b>GCM43Q7U3A272JX01#</b>
			3300pF	±5%	<b>GCM43Q7U3A332JX01#</b>
	630Vdc	U2J	12000pF	±5%	<b>GCM43Q7U2J123JX01#</b>
2.0mm	1000Vdc	U2J	3900pF	±5%	<b>GCM43D7U3A392JX01#</b>
			4700pF	±5%	<b>GCM43D7U3A472JX01#</b>
	630Vdc	U2J	15000pF	±5%	<b>GCM43D7U2J153JX01#</b>
			18000pF	±5%	<b>GCM43D7U2J183JX01#</b>
			22000pF	±5%	<b>GCM43D7U2J223JX01#</b>

■ 5.7×5.0mm

T max.	Rated Voltage	TC Code	Cap.	Tol.	Part Number
1.5mm	1000Vdc	U2J	5600pF	±5%	<b>GCM55Q7U3A562JX01#</b>
			6800pF	±5%	<b>GCM55Q7U3A682JX01#</b>
	630Vdc	U2J	27000pF	±5%	<b>GCM55Q7U2J273JX01#</b>
2.0mm	1000Vdc	U2J	8200pF	±5%	<b>GCM55D7U3A822JX01#</b>
			10000pF	±5%	<b>GCM55D7U3A103JX01#</b>
	630Vdc	U2J	33000pF	±5%	<b>GCM55D7U2J333JX01#</b>
			39000pF	±5%	<b>GCM55D7U2J393JX01#</b>
			47000pF	±5%	<b>GCM55D7U2J473JX01#</b>

GCM Series

GCD Series

GCE Series

GCG Series

GCJ Series

GC3 Series

KCM Series

KC3 Series

⚠Caution/Notice



# GCM Series High Dielectric Constant Type Part Number List

## ■ 0.6×0.3mm

T max.	Rated Voltage	TC Code	Cap.	Tol.	Part Number
0.33mm	25Vdc	X7R	100pF	±10%	GCM033R71E101KA03#
			150pF	±10%	GCM033R71E151KA03#
			220pF	±10%	GCM033R71E221KA03#
			330pF	±10%	GCM033R71E331KA03#
			470pF	±10%	GCM033R71E471KA03#
			680pF	±10%	GCM033R71E681KA03#
			1000pF	±10%	GCM033R71E102KA03#
			1500pF	±10%	GCM033R71E152KA03#
	16Vdc	X7R	2200pF	±10%	GCM033R71C222KA55#
			3300pF	±10%	GCM033R71C332KA55#
	10Vdc	X7R	4700pF	±10%	GCM033R71A472KA03#
			6800pF	±10%	GCM033R71A682KA03#
			10000pF	±10%	GCM033R71A103KA03#

## ■ 1.0×0.5mm

T max.	Rated Voltage	TC Code	Cap.	Tol.	Part Number		
0.55mm	100Vdc	X7R	220pF	±10%	GCM155R72A221KA37#		
			330pF	±10%	GCM155R72A331KA37#		
			470pF	±10%	GCM155R72A471KA37#		
			680pF	±10%	GCM155R72A681KA37#		
			1000pF	±10%	GCM155R72A102KA37#		
			1500pF	±10%	GCM155R72A152KA37#		
			2200pF	±10%	GCM155R72A222KA37#		
			3300pF	±10%	GCM155R72A332KA37#		
			4700pF	±10%	GCM155R72A472KA37#		
			50Vdc	X7R	220pF	±10%	GCM155R71H221KA37#
					330pF	±10%	GCM155R71H331KA37#
					470pF	±10%	GCM155R71H471KA37#
					680pF	±10%	GCM155R71H681KA37#
					1000pF	±10%	GCM155R71H102KA37#
	1500pF	±10%			GCM155R71H152KA37#		
	2200pF	±10%			GCM155R71H222KA37#		
	3300pF	±10%			GCM155R71H332KA37#		
	4700pF	±10%			GCM155R71H472KA37#		
	6800pF	±10%			GCM155R71H682KA55#		
	10000pF	±10%			GCM155R71H103KA55#		
	15000pF	±10%			GCM155R71H153KA55#		
	22000pF	±10%			GCM155R71H223KA55#		
	33000pF	±10%			GCM155R71H333KE02#		
	47000pF	±10%			GCM155R71H473KE02#		
	68000pF	±10%			GCM155R71H683KE02#		
	0.10μF	±10%			GCM155R71H104KE02#		
	25Vdc	X7R			10000pF	±10%	GCM155R71E103KA37#
			15000pF	±10%	GCM155R71E153KA55#		
			22000pF	±10%	GCM155R71E223KA55#		
			33000pF	±10%	GCM155R71E333KA55#		
			47000pF	±10%	GCM155R71E473KA55#		
			68000pF	±10%	GCM155R71E683KA55#		
	16Vdc	X7R	33000pF	±10%	GCM155R71C333KA37#		
			47000pF	±10%	GCM155R71C473KA37#		
			68000pF	±10%	GCM155R71C683KA55#		
			0.10μF	±10%	GCM155R71C104KA55#		

T max.	Rated Voltage	TC Code	Cap.	Tol.	Part Number
0.55mm	16Vdc	X7R	0.10μF	±10%	GCM155R71C104KA55#
			0.15μF	±10%	GCM155R71C154KE02#
			0.22μF	±10%	GCM155R71C224KE02#

## ■ 1.6×0.8mm

T max.	Rated Voltage	TC Code	Cap.	Tol.	Part Number		
0.9mm	100Vdc	X7R	1000pF	±10%	GCM188R72A102KA37#		
			1500pF	±10%	GCM188R72A152KA37#		
			2200pF	±10%	GCM188R72A222KA37#		
			3300pF	±10%	GCM188R72A332KA37#		
			4700pF	±10%	GCM188R72A472KA37#		
			6800pF	±10%	GCM188R72A682KA37#		
			10000pF	±10%	GCM188R72A103KA37#		
			15000pF	±10%	GCM188R72A153KA37#		
			22000pF	±10%	GCM188R72A223KA37#		
			50Vdc	X7R	1000pF	±10%	GCM188R71H102KA37#
					1500pF	±10%	GCM188R71H152KA37#
					2200pF	±10%	GCM188R71H222KA37#
					3300pF	±10%	GCM188R71H332KA37#
					4700pF	±10%	GCM188R71H472KA37#
	6800pF	±10%			GCM188R71H682KA37#		
	10000pF	±10%			GCM188R71H103KA37#		
	15000pF	±10%			GCM188R71H153KA37#		
	22000pF	±10%			GCM188R71H223KA37#		
	33000pF	±10%			GCM188R71H333KA55#		
	47000pF	±10%			GCM188R71H473KA55#		
	68000pF	±10%			GCM188R71H683KA57#		
	0.10μF	±10%			GCM188R71H104KA57#		
	0.15μF	±10%			GCM188R71H154KA64#		
	0.22μF	±10%			GCM188R71H224KA64#		
	25Vdc	X7R			33000pF	±10%	GCM188R71E333KA37#
					47000pF	±10%	GCM188R71E473KA37#
					68000pF	±10%	GCM188R71E683KA57#
					0.10μF	±10%	GCM188R71E104KA57#
			0.15μF	±10%	GCM188R71E154KA37#		
			0.22μF	±10%	GCM188R71E224KA55#		
			0.47μF	±10%	GCM188R71E474KA64#		
			1.0μF	±10%	GCM188R71E105KA64#		
	16Vdc	X7R	0.10μF	±10%	GCM188R71C104KA37#		
0.33μF			±10%	GCM188R71C334KA37#			
0.47μF			±10%	GCM188R71C474KA55#			
6.3Vdc	X7R	1.0μF	±10%	GCM188R71C105KA64#			
		2.2μF	±10%	GCM188R70J225KE22#			

## ■ 2.0×1.25mm

T max.	Rated Voltage	TC Code	Cap.	Tol.	Part Number
0.7mm	100Vdc	X7R	6800pF	±10%	GCM216R72A682KA37#
			10000pF	±10%	GCM216R72A103KA37#
			15000pF	±10%	GCM216R72A153KA37#
			22000pF	±10%	GCM216R72A223KA37#

Part number # indicates the package specification code.

# GCM Series High Dielectric Constant Type AEC-Q200 Part Number List

(→ ■ 2.0x1.25mm)

T max.	Rated Voltage	TC Code	Cap.	Tol.	Part Number		
0.95mm	100Vdc	X7R	33000pF	±10%	GCM219R72A333KA37#		
	50Vdc	X7R	33000pF	±10%	GCM219R71H333KA37#		
			0.33μF	±10%	GCM219R71H334KA55#		
	25Vdc	X7R	0.47μF	±10%	GCM219R71E474KA55#		
	16Vdc	X7R	0.68μF	±10%	GCM219R71C684KA37#		
1.0μF			±10%	GCM219R71C105KA37#			
1.4mm	100Vdc	X7R	47000pF	±10%	GCM21BR72A473KA37#		
			68000pF	±10%	GCM21BR72A683KA37#		
			0.10μF	±10%	GCM21BR72A104KA37#		
			50Vdc	X7R	47000pF	±10%	GCM21BR71H473KA37#
					68000pF	±10%	GCM21BR71H683KA37#
					0.10μF	±10%	GCM21BR71H104KA37#
	0.15μF	±10%			GCM21BR71H154KA37#		
	0.22μF	±10%			GCM21BR71H224KA37#		
	35Vdc	X7R	0.47μF	±10%	GCM21BR71H474KA55#		
			1.0μF	±10%	GCM21BR71H105KA03#		
			0.68μF	±10%	GCM21BR7YA684KA55#		
			1.0μF	±10%	GCM21BR7YA105KA55#		
			1.5μF	±10%	GCM21BR7YA155KA54#		
			25Vdc	X7R	0.15μF	±10%	GCM21BR71E154KA37#
	0.22μF	±10%			GCM21BR71E224KA37#		
	0.33μF	±10%			GCM21BR71E334KA37#		
	0.68μF	±10%			GCM21BR71E684KA55#		
	1.0μF	±10%			GCM21BR71E105KA56#		
	2.2μF	±10%			GCM21BR71E225KA73#		
	16Vdc	X7R			2.2μF	±10%	GCM21BR71C225KA64#
			4.7μF	±10%	GCM21BR71C475KA73#		
			10Vdc	X7R	2.2μF	±10%	GCM21BR71A225KA37#
	10μF	±10%			GCM21BR71A106KE22#		
	X7S	4.7μF			±10%	GCM21BC71A475KA73#	
	6.3Vdc	X7R	10μF	±10%	GCM21BR70J106KE22#		

■ 3.2x2.5mm

T max.	Rated Voltage	TC Code	Cap.	Tol.	Part Number
2.2mm	25Vdc	X7R	4.7μF	±10%	GCM32DR71E475KA55#
	16Vdc	X7R	10μF	±10%	GCM32DR71C106KA37#
2.7mm	50Vdc	X7R	1.0μF	±10%	GCM32ER71H105KA37#
			4.7μF	±10%	GCM32ER71H475KA55#
	35Vdc	X7S	10μF	±10%	GCM32EC71H106KA03#
			10μF	±10%	GCM32EC7YA106KA03#
	25Vdc	X7R	10μF	±10%	GCM32ER71E106KA57#
	16Vdc	X7R	22μF	±20%	GCM32ER71C226ME19#
10Vdc	X7R	22μF	±20%	GCM32ER71A226ME12#	
6.3Vdc	X7R	47μF	±20%	GCM32ER70J476ME19#	

■ 3.2x1.6mm

T max.	Rated Voltage	TC Code	Cap.	Tol.	Part Number		
0.95mm	100Vdc	X7R	0.10μF	±10%	GCM319R72A104KA37#		
1.25mm	100Vdc	X7R	0.15μF	±10%	GCM31MR72A154KA37#		
			0.22μF	±10%	GCM31MR72A224KA37#		
	50Vdc	X7R	0.33μF	±10%	GCM31MR71H334KA37#		
			0.47μF	±10%	GCM31MR71H474KA37#		
			0.68μF	±10%	GCM31MR71H684KA55#		
1.0μF	±10%	GCM31MR71H105KA55#					
1.3mm	25Vdc	X7R	2.2μF	±10%	GCM31MR71E225KA57#		
1.8mm	100Vdc	X7R	1.0μF	±10%	GCM31CR72A105KA03#		
			50Vdc	X7R	2.2μF	±10%	GCM31CR71H225KA55#
					X7S	4.7μF	±10%
	25Vdc	X7R	4.7μF	±10%	GCM31CR71E475KA55#		
	16Vdc	X7R	4.7μF	±10%	GCM31CR71C475KA37#		
			10μF	±10%	GCM31CR71C106KA64#		
	10Vdc	X7R	10μF	±10%	GCM31CR71A106KA64#		
			22μF	±10%	GCM31CR71A226KE02#		
6.3Vdc	X7R	22μF	±20%	GCM31CR70J226ME23#			
1.9mm	25Vdc	X7S	10μF	±10%	GCM31CC71E106KA03#		

Part number # indicates the package specification code.

Specially Designed Product to Reduce Shorts

# GCD Series



AEC-Q200

Fail safe

Deflecting crack

**Prevents momentary dielectric breakdown by a two-element array structure!**

## Features

**① Prevents momentary dielectric breakdown by a two-element array structure!**

This product consists of two elements arranged in one capacitor. It is structured so that even when one element is shorted, the other capacitor element will not short.

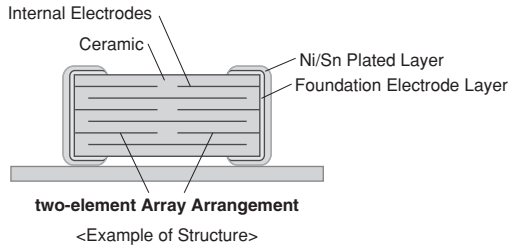

**② This AEC-Q200 conforming product is ideal for battery lines of automobiles.**

Space can be reduced in battery lines where two capacitors are arranged in an array.

## Specifications

Size	1.6x0.8mm to 2.0x1.25mm
Rated Voltage	25Vdc to 100Vdc
Capacitance	1,000pF to 0.1μF
Main Applications	Battery lines and power trains for automobiles

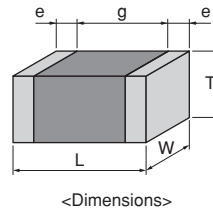

GCM Series

GCD Series

GCE Series

GCG Series

GCM Series

GCM Series

KCM Series

KC3 Series

⚠Caution/Notice

# GCD Series High Dielectric Constant Type AEC-Q200 Fail safe Deflecting crack Part Number List

## ■ 1.6x0.8mm

T max.	Rated Voltage	TC Code	Cap.	Tol.	Part Number
0.9mm	100Vdc	X7R	1000pF	±10%	GCD188R72A102KA01#
			1200pF	±10%	GCD188R72A122KA01#
			1500pF	±10%	GCD188R72A152KA01#
			1800pF	±10%	GCD188R72A182KA01#
			2200pF	±10%	GCD188R72A222KA01#
			2700pF	±10%	GCD188R72A272KA01#
			3300pF	±10%	GCD188R72A332KA01#
			3900pF	±10%	GCD188R72A392KA01#
			4700pF	±10%	GCD188R72A472KA01#
			5600pF	±10%	GCD188R72A562KA01#
			6800pF	±10%	GCD188R72A682KA01#
			8200pF	±10%	GCD188R72A822KA01#
			10000pF	±10%	GCD188R72A103KA01#
			12000pF	±10%	GCD188R72A123KA01#
			15000pF	±10%	GCD188R72A153KA01#
			18000pF	±10%	GCD188R72A183KA01#
			22000pF	±10%	GCD188R72A223KA01#
			50Vdc	X7R	1000pF
	1200pF	±10%			GCD188R71H122KA01#
	1500pF	±10%			GCD188R71H152KA01#
	1800pF	±10%			GCD188R71H182KA01#
	2200pF	±10%			GCD188R71H222KA01#
	2700pF	±10%			GCD188R71H272KA01#
	3300pF	±10%			GCD188R71H332KA01#
	3900pF	±10%			GCD188R71H392KA01#
	4700pF	±10%			GCD188R71H472KA01#
	5600pF	±10%			GCD188R71H562KA01#
	25Vdc	X7R	2700pF	±10%	GCD188R71E273KA01#
3300pF			±10%	GCD188R71E333KA01#	
3900pF			±10%	GCD188R71E393KA01#	
4700pF			±10%	GCD188R71E473KA01#	

T max.	Rated Voltage	TC Code	Cap.	Tol.	Part Number			
0.7mm	100Vdc	X7R	5600pF	±10%	GCD216R72A562KA01#			
			1000pF	±10%	GCD216R71H102KA01#			
			1200pF	±10%	GCD216R71H122KA01#			
			1500pF	±10%	GCD216R71H152KA01#			
			1800pF	±10%	GCD216R71H182KA01#			
			2200pF	±10%	GCD216R71H222KA01#			
	50Vdc	X7R	2700pF	±10%	GCD216R71H272KA01#			
			3300pF	±10%	GCD216R71H332KA01#			
			3900pF	±10%	GCD216R71H392KA01#			
			4700pF	±10%	GCD216R71H472KA01#			
			5600pF	±10%	GCD216R71H562KA01#			
			0.95mm	100Vdc	X7R	6800pF	±10%	GCD219R72A682KA01#
1.4mm	100Vdc	X7R				8200pF	±10%	GCD21BR72A822KA01#
						10000pF	±10%	GCD21BR72A103KA01#
						12000pF	±10%	GCD21BR72A123KA01#
						15000pF	±10%	GCD21BR72A153KA01#
						18000pF	±10%	GCD21BR72A183KA01#
				22000pF	±10%	GCD21BR72A223KA01#		
50Vdc	X7R	27000pF		±10%	GCD21BR72A273KA01#			
		33000pF		±10%	GCD21BR72A333KA01#			
		39000pF		±10%	GCD21BR72A393KA01#			
		47000pF		±10%	GCD21BR72A473KA01#			
		56000pF		±10%	GCD21BR72A563KA01#			
		68000pF	±10%	GCD21BR72A683KA01#				
	X7R	8200pF	±10%	GCD21BR72A823KA01#				
		0.10μF	±10%	GCD21BR72A104KA01#				
		15000pF	±10%	GCD21BR71H153KA01#				
		18000pF	±10%	GCD21BR71H183KA01#				
		22000pF	±10%	GCD21BR71H223KA01#				
		27000pF	±10%	GCD21BR71H273KA01#				
X7R	33000pF	±10%	GCD21BR71H333KA01#					
	39000pF	±10%	GCD21BR71H393KA01#					
	47000pF	±10%	GCD21BR71H473KA01#					
	56000pF	±10%	GCD21BR71H563KA01#					
	68000pF	±10%	GCD21BR71H683KA01#					
	82000pF	±10%	GCD21BR71H823KA01#					
0.10μF	±10%	GCD21BR71H104KA01#						

## ■ 2.0x1.25mm

T max.	Rated Voltage	TC Code	Cap.	Tol.	Part Number
0.7mm	100Vdc	X7R	1000pF	±10%	GCD216R72A102KA01#
			1200pF	±10%	GCD216R72A122KA01#
			1500pF	±10%	GCD216R72A152KA01#
			1800pF	±10%	GCD216R72A182KA01#
			2200pF	±10%	GCD216R72A222KA01#
			2700pF	±10%	GCD216R72A272KA01#
			3300pF	±10%	GCD216R72A332KA01#
			3900pF	±10%	GCD216R72A392KA01#
			4700pF	±10%	GCD216R72A472KA01#

Part number # indicates the package specification code.

GCM Series  
 GCD Series  
 GCE Series  
 GCG Series  
 GCJ Series  
 GC3 Series  
 KCM Series  
 KC3 Series  
 ⚠Caution/Notice

Specially Designed Product to Reduce Shorts & Resin Electrode Product

# GCE Series



**Further improved safety performance with a combination of a two-element array structure & resin external electrodes!**

## Features

**① Avoid instantaneous dielectric breakdown with the two-element array structure.**

This product is configured with two elements arranged in one capacitor. Even if one element short circuits, the other element in the capacitor does not short.

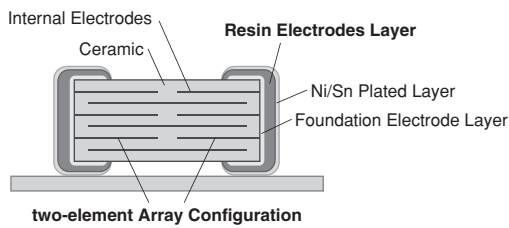

**② Provides additional safety performance in combination with resin electrodes.**

Adopting resin electrodes as the external electrodes will suppress the occurrence of cracking in the capacitor by mechanical stress.

● For Automobiles (GCM Series)

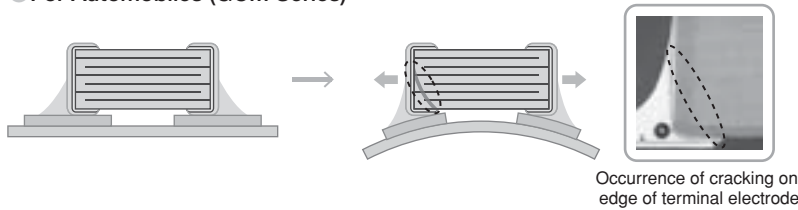

● Fail Safe Type (GCE Series)

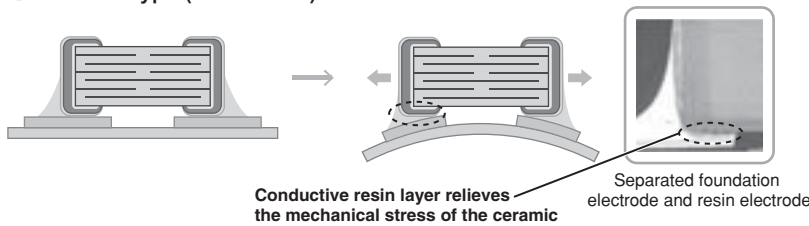

**③ Ideal for battery lines of on-board applications.**

Space can be reduced for battery lines, when two capacitors are configured in an array.

## Specifications

Size	1.6×0.8mm to 2.0×1.25mm
Rated Voltage	50Vdc to 100Vdc
Capacitance	1000pF to 0.1μF
Main Applications	For automotive, battery lines, power trains

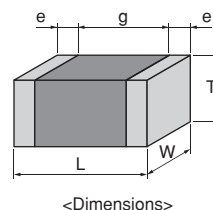

GCM Series

GCD Series

GCE Series

GCG Series

G CJ Series

G C3 Series

KCM Series

KC3 Series

⚠Caution/Notice

# GCE Series High Dielectric Constant Type AEC-Q200 Fail safe Deflecting crack Part Number List

## ■ 1.6x0.8mm

T max.	Rated Voltage	TC Code	Cap.	Tol.	Part Number		
0.9mm	100Vdc	X7R	1000pF	±10%	GCE188R72A102KA01#		
			1200pF	±10%	GCE188R72A122KA01#		
			1500pF	±10%	GCE188R72A152KA01#		
			1800pF	±10%	GCE188R72A182KA01#		
			2200pF	±10%	GCE188R72A222KA01#		
			2700pF	±10%	GCE188R72A272KA01#		
			3300pF	±10%	GCE188R72A332KA01#		
			3900pF	±10%	GCE188R72A392KA01#		
			4700pF	±10%	GCE188R72A472KA01#		
			5600pF	±10%	GCE188R72A562KA01#		
			6800pF	±10%	GCE188R72A682KA01#		
			8200pF	±10%	GCE188R72A822KA01#		
			10000pF	±10%	GCE188R72A103KA01#		
			12000pF	±10%	GCE188R72A123KA01#		
			15000pF	±10%	GCE188R72A153KA01#		
			18000pF	±10%	GCE188R72A183KA01#		
			22000pF	±10%	GCE188R72A223KA01#		
			50Vdc	X7R	1000pF	±10%	GCE188R71H102KA01#
					1200pF	±10%	GCE188R71H122KA01#
					1500pF	±10%	GCE188R71H152KA01#
1800pF	±10%	GCE188R71H182KA01#					
2200pF	±10%	GCE188R71H222KA01#					
2700pF	±10%	GCE188R71H272KA01#					
3300pF	±10%	GCE188R71H332KA01#					
3900pF	±10%	GCE188R71H392KA01#					
4700pF	±10%	GCE188R71H472KA01#					
5600pF	±10%	GCE188R71H562KA01#					
6800pF	±10%	GCE188R71H682KA01#					
8200pF	±10%	GCE188R71H822KA01#					
10000pF	±10%	GCE188R71H103KA01#					
12000pF	±10%	GCE188R71H123KA01#					
15000pF	±10%	GCE188R71H153KA01#					
18000pF	±10%	GCE188R71H183KA01#					
22000pF	±10%	GCE188R71H223KA01#					

T max.	Rated Voltage	TC Code	Cap.	Tol.	Part Number		
0.7mm	50Vdc	X7R	1800pF	±10%	GCE216R71H182KA01#		
			2200pF	±10%	GCE216R71H222KA01#		
			2700pF	±10%	GCE216R71H272KA01#		
			3300pF	±10%	GCE216R71H332KA01#		
			3900pF	±10%	GCE216R71H392KA01#		
			4700pF	±10%	GCE216R71H472KA01#		
			5600pF	±10%	GCE216R71H562KA01#		
0.95mm	100Vdc	X7R	6800pF	±10%	GCE219R72A682KA01#		
1.45mm	100Vdc	X7R	8200pF	±10%	GCE21BR72A822KA01#		
			10000pF	±10%	GCE21BR72A103KA01#		
			12000pF	±10%	GCE21BR72A123KA01#		
			15000pF	±10%	GCE21BR72A153KA01#		
			18000pF	±10%	GCE21BR72A183KA01#		
			22000pF	±10%	GCE21BR72A223KA01#		
			27000pF	±10%	GCE21BR72A273KA01#		
			33000pF	±10%	GCE21BR72A333KA01#		
			39000pF	±10%	GCE21BR72A393KA01#		
			47000pF	±10%	GCE21BR72A473KA01#		
			56000pF	±10%	GCE21BR72A563KA01#		
			68000pF	±10%	GCE21BR72A683KA01#		
			82000pF	±10%	GCE21BR72A823KA01#		
			0.10μF	±10%	GCE21BR72A104KA01#		
			50Vdc	X7R	15000pF	±10%	GCE21BR71H153KA01#
					18000pF	±10%	GCE21BR71H183KA01#
					22000pF	±10%	GCE21BR71H223KA01#
					27000pF	±10%	GCE21BR71H273KA01#
					33000pF	±10%	GCE21BR71H333KA01#
					39000pF	±10%	GCE21BR71H393KA01#
47000pF	±10%	GCE21BR71H473KA01#					
56000pF	±10%	GCE21BR71H563KA01#					
68000pF	±10%	GCE21BR71H683KA01#					
82000pF	±10%	GCE21BR71H823KA01#					
0.10μF	±10%	GCE21BR71H104KA01#					

## ■ 2.0x1.25mm

T max.	Rated Voltage	TC Code	Cap.	Tol.	Part Number		
0.7mm	100Vdc	X7R	1000pF	±10%	GCE216R72A102KA01#		
			1200pF	±10%	GCE216R72A122KA01#		
			1500pF	±10%	GCE216R72A152KA01#		
			1800pF	±10%	GCE216R72A182KA01#		
			2200pF	±10%	GCE216R72A222KA01#		
			2700pF	±10%	GCE216R72A272KA01#		
			3300pF	±10%	GCE216R72A332KA01#		
			3900pF	±10%	GCE216R72A392KA01#		
			4700pF	±10%	GCE216R72A472KA01#		
			5600pF	±10%	GCE216R72A562KA01#		
			50Vdc	X7R	1000pF	±10%	GCE216R71H102KA01#
					1200pF	±10%	GCE216R71H122KA01#
					1500pF	±10%	GCE216R71H152KA01#

Part number # indicates the package specification code.

GCM Series  
 GCD Series  
 GCE Series  
 GCG Series  
 GCJ Series  
 GCS Series  
 KCM Series  
 KC3 Series  
 ⚠Caution/Notice

Conductivity Adhesive Compatible Type

# GCG Series



AEC-Q200

Deflecting crack

Soldering crack

Improved mechanical and thermal strength by adopting AgPd external electrodes, which can be mounted with a conductive adhesive!

## Features

① **Conductive adhesives can be used.**

This capacitor can be mounted with a conductive adhesive\* in power trains and safety devices of automobiles.

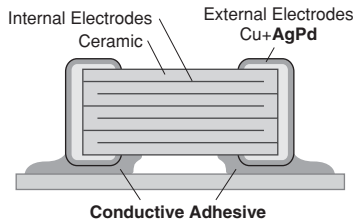

② **Adopted AgPd external electrodes.**

Adopted AgPd, which is excellent in bonding strength with a conductive adhesive.

③ **Compatible up to 150 °C.**

This capacitor lineup with X8L and X8R characteristics can be used in high-temperature environments, such as in ABS and transmission control.

\* The conductive adhesive buffers the expansion and contraction difference between the substrate and parts caused by temperature changes, and has a high temperature cycle life span.

## Specifications

Size	1.0x0.5mm to 3.2x2.5mm
Rated Voltage	16Vdc to 100Vdc
Capacitance	10pF to 10μF
Main Applications	For automotive, power trains, sensors

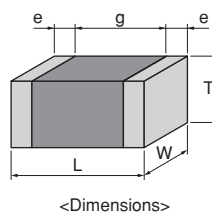

GCM Series

GCD Series

GCE Series

GCG Series

G CJ Series

G C3 Series

KCM Series

KC3 Series

⚠Caution/Notice

# GCG Series Temperature Compensating Type AEC-Q200 Deflecting crack Soldering crack Part Number List

## ■ 1.0x0.5mm

T max.	Rated Voltage	TC Code	Cap.	Tol.	Part Number
0.55mm	50Vdc	X8G	120pF	±5%	GCG1555G1H121JA01#
			150pF	±5%	GCG1555G1H151JA01#
			180pF	±5%	GCG1555G1H181JA01#
			220pF	±5%	GCG1555G1H221JA01#
			270pF	±5%	GCG1555G1H271JA01#
			330pF	±5%	GCG1555G1H331JA01#
			390pF	±5%	GCG1555G1H391JA01#
			470pF	±5%	GCG1555G1H471JA01#

## ■ 1.6x0.8mm

T max.	Rated Voltage	TC Code	Cap.	Tol.	Part Number
0.9mm	50Vdc	X8G	10pF	±5%	GCG1885G1H100JA01#
			12pF	±5%	GCG1885G1H120JA01#
			15pF	±5%	GCG1885G1H150JA01#
			18pF	±5%	GCG1885G1H180JA01#
			22pF	±5%	GCG1885G1H220JA01#
			27pF	±5%	GCG1885G1H270JA01#
			33pF	±5%	GCG1885G1H330JA01#
			39pF	±5%	GCG1885G1H390JA01#
			47pF	±5%	GCG1885G1H470JA01#
			56pF	±5%	GCG1885G1H560JA01#
			68pF	±5%	GCG1885G1H680JA01#
			82pF	±5%	GCG1885G1H820JA01#
			100pF	±5%	GCG1885G1H101JA01#
			120pF	±5%	GCG1885G1H121JA01#
			150pF	±5%	GCG1885G1H151JA01#
			180pF	±5%	GCG1885G1H181JA01#
			220pF	±5%	GCG1885G1H221JA01#
			270pF	±5%	GCG1885G1H271JA01#
			330pF	±5%	GCG1885G1H331JA01#
			390pF	±5%	GCG1885G1H391JA01#
			470pF	±5%	GCG1885G1H471JA01#
			560pF	±5%	GCG1885G1H561JA01#
			680pF	±5%	GCG1885G1H681JA01#
			820pF	±5%	GCG1885G1H821JA01#
			1000pF	±5%	GCG1885G1H102JA01#
			1200pF	±5%	GCG1885G1H122JA01#
			1500pF	±5%	GCG1885G1H152JA01#
			1800pF	±5%	GCG1885G1H182JA01#
			2200pF	±5%	GCG1885G1H222JA01#

## ■ 2.0x1.25mm

T max.	Rated Voltage	TC Code	Cap.	Tol.	Part Number
0.7mm	50Vdc	X8G	100pF	±5%	GCG2165G1H101JA01#
			120pF	±5%	GCG2165G1H121JA01#
			150pF	±5%	GCG2165G1H151JA01#
			180pF	±5%	GCG2165G1H181JA01#
			220pF	±5%	GCG2165G1H221JA01#

T max.	Rated Voltage	TC Code	Cap.	Tol.	Part Number
0.7mm	50Vdc	X8G	270pF	±5%	GCG2165G1H271JA01#
			330pF	±5%	GCG2165G1H331JA01#
			390pF	±5%	GCG2165G1H391JA01#
			470pF	±5%	GCG2165G1H471JA01#
			560pF	±5%	GCG2165G1H561JA01#
			680pF	±5%	GCG2165G1H681JA01#
			820pF	±5%	GCG2165G1H821JA01#
			1000pF	±5%	GCG2165G1H102JA01#
			1200pF	±5%	GCG2165G1H122JA01#
			1500pF	±5%	GCG2165G1H152JA01#
			1800pF	±5%	GCG2165G1H182JA01#
			2200pF	±5%	GCG2165G1H222JA01#
			2700pF	±5%	GCG2165G1H272JA01#
			3300pF	±5%	GCG2165G1H332JA01#
			3900pF	±5%	GCG2165G1H392JA01#
			4700pF	±5%	GCG2165G1H472JA01#
			0.95mm	50Vdc	X8G
6800pF	±5%	GCG2195G1H682JA01#			
8200pF	±5%	GCG2195G1H822JA01#			
10000pF	±5%	GCG2195G1H103JA01#			

GCM Series

GCD Series

GCE Series

GCG Series

GCJ Series

GCG Series

KCM Series

KC3 Series

⚠Caution/Notice

Part number # indicates the package specification code.



# GCG Series High Dielectric Constant Type AEC-Q200 Defecting crack Soldering crack Part Number List

## ■ 1.0x0.5mm

T max.	Rated Voltage	TC Code	Cap.	Tol.	Part Number		
0.55mm	50Vdc	X7R	220pF	±10%	GCG155R71H221KA01#		
			270pF	±10%	GCG155R71H271KA01#		
			330pF	±10%	GCG155R71H331KA01#		
			390pF	±10%	GCG155R71H391KA01#		
			470pF	±10%	GCG155R71H471KA01#		
			560pF	±10%	GCG155R71H561KA01#		
			680pF	±10%	GCG155R71H681KA01#		
			820pF	±10%	GCG155R71H821KA01#		
			1000pF	±10%	GCG155R71H102KA01#		
			1200pF	±10%	GCG155R71H122KA01#		
			1500pF	±10%	GCG155R71H152KA01#		
			1800pF	±10%	GCG155R71H182KA01#		
			2200pF	±10%	GCG155R71H222KA01#		
			2700pF	±10%	GCG155R71H272KA01#		
			3300pF	±10%	GCG155R71H332KA01#		
			3900pF	±10%	GCG155R71H392KA01#		
			4700pF	±10%	GCG155R71H472KA01#		
			25Vdc	X8L	5600pF	±10%	GCG155L81E562KA01#
					6800pF	±10%	GCG155L81E682KA01#
					8200pF	±10%	GCG155L81E822KA01#
					10000pF	±10%	GCG155L81E103KA01#
	X7R	5600pF			±10%	GCG155R71E562KA01#	
		6800pF			±10%	GCG155R71E682KA01#	
		8200pF			±10%	GCG155R71E822KA01#	
		10000pF			±10%	GCG155R71E103KA01#	
		16Vdc			X8L	15000pF	±10%
				18000pF		±10%	GCG155L81C183KA01#
	22000pF			±10%		GCG155L81C223KA01#	
	27000pF			±10%		GCG155L81C273KA01#	
	33000pF			±10%		GCG155L81C333KA01#	
	39000pF			±10%		GCG155L81C393KA01#	
	47000pF	±10%		GCG155L81C473KA01#			
	X7R	15000pF		±10%		GCG155R71C153KA01#	
		18000pF		±10%		GCG155R71C183KA01#	
		22000pF		±10%	GCG155R71C223KA01#		
		27000pF		±10%	GCG155R71C273KA01#		
		33000pF		±10%	GCG155R71C333KA01#		
		39000pF		±10%	GCG155R71C393KA01#		
		47000pF	±10%	GCG155R71C473KA01#			
		56000pF	±10%	GCG155R71C563KA01#			
		68000pF	±10%	GCG155R71C683KA01#			
		82000pF	±10%	GCG155R71C823KA01#			
0.1μF		±10%	GCG155R71C104KA01#				

## ■ 1.6x0.8mm

T max.	Rated Voltage	TC Code	Cap.	Tol.	Part Number
0.9mm	100Vdc	X8R	1000pF	±10%	GCG188R92A102KA01#
			1200pF	±10%	GCG188R92A122KA01#
			1500pF	±10%	GCG188R92A152KA01#
			1800pF	±10%	GCG188R92A182KA01#

T max.	Rated Voltage	TC Code	Cap.	Tol.	Part Number		
0.9mm	100Vdc	X8R	2200pF	±10%	GCG188R92A222KA01#		
			2700pF	±10%	GCG188R92A272KA01#		
			3300pF	±10%	GCG188R92A332KA01#		
			3900pF	±10%	GCG188R92A392KA01#		
			4700pF	±10%	GCG188R92A472KA01#		
			5600pF	±10%	GCG188R92A562KA01#		
			6800pF	±10%	GCG188R92A682KA01#		
			8200pF	±10%	GCG188R92A822KA01#		
			10000pF	±10%	GCG188R92A103KA01#		
			12000pF	±10%	GCG188R92A123KA01#		
			15000pF	±10%	GCG188R92A153KA01#		
			18000pF	±10%	GCG188R92A183KA01#		
			22000pF	±10%	GCG188R92A223KA01#		
			27000pF	±10%	GCG188R92A273KA01#		
			33000pF	±10%	GCG188R92A333KA01#		
			39000pF	±10%	GCG188R92A393KA01#		
			47000pF	±10%	GCG188R92A473KA01#		
			56000pF	±10%	GCG188R92A563KA01#		
			68000pF	±10%	GCG188R92A683KA01#		
			50Vdc	X8L	220pF	±10%	GCG188L81H221KA01#
					270pF	±10%	GCG188L81H271KA01#
	330pF	±10%			GCG188L81H331KA01#		
	390pF	±10%			GCG188L81H391KA01#		
	470pF	±10%			GCG188L81H471KA01#		
	560pF	±10%			GCG188L81H561KA01#		
	680pF	±10%			GCG188L81H681KA01#		
	820pF	±10%			GCG188L81H821KA01#		
	1000pF	±10%			GCG188L81H102KA01#		
	X8R	1200pF		±10%	GCG188R91H122KA03#		
		1500pF		±10%	GCG188R91H152KA03#		
		2200pF		±10%	GCG188R91H222KA03#		
		2700pF		±10%	GCG188R91H272KA03#		
		3300pF		±10%	GCG188R91H332KA03#		
		3900pF		±10%	GCG188R91H392KA03#		
		4700pF		±10%	GCG188R91H472KA03#		
		5600pF		±10%	GCG188R91H562KA03#		
		6800pF		±10%	GCG188R91H682KA03#		
		8200pF		±10%	GCG188R91H822KA03#		

GCM Series  
 GCD Series  
 GCE Series  
 GCG Series  
 GCJ Series  
 GC3 Series  
 KCM Series  
 KC3 Series  
 ⚠Caution/Notice

Part number # indicates the package specification code.

# GCG Series High Dielectric Constant Type AEC-Q200 Deflecting crack Soldering crack Part Number List

(→ ■ 1.6x0.8mm)

T max.	Rated Voltage	TC Code	Cap.	Tol.	Part Number	
0.9mm	50Vdc	X8R	10000pF	±10%	GCG188R91H103KA03#	
			15000pF	±10%	GCG188R91H153KA03#	
			22000pF	±10%	GCG188R91H223KA03#	
			33000pF	±10%	GCG188R91H333KA03#	
			47000pF	±10%	GCG188R91H473KA03#	
			0.10μF	±10%	GCG188R91H104KA01#	
			0.12μF	±10%	GCG188R91H124KA01#	
			0.15μF	±10%	GCG188R91H154KA01#	
			0.18μF	±10%	GCG188R91H184KA01#	
		0.22μF	±10%	GCG188R91H224KA01#		
		X7R	27000pF	±10%	GCG188R71H273KA12#	
			33000pF	±10%	GCG188R71H333KA12#	
			39000pF	±10%	GCG188R71H393KA12#	
			47000pF	±10%	GCG188R71H473KA12#	
			56000pF	±10%	GCG188R71H563KA12#	
			68000pF	±10%	GCG188R71H683KA12#	
			82000pF	±10%	GCG188R71H823KA12#	
			25Vdc	X8R	1000pF	±10%
	1200pF				±10%	GCG188R91E122KA01#
	1500pF	±10%			GCG188R91E152KA01#	
	1800pF	±10%			GCG188R91E182KA01#	
	2200pF	±10%			GCG188R91E222KA01#	
	2700pF	±10%			GCG188R91E272KA01#	
	X7R	3300pF		±10%	GCG188R91E332KA01#	
		3900pF		±10%	GCG188R91E392KA01#	
		4700pF		±10%	GCG188R91E472KA01#	
		5600pF		±10%	GCG188R91E562KA01#	
		6800pF		±10%	GCG188R91E682KA01#	
		8200pF		±10%	GCG188R91E822KA01#	
	16Vdc	X8L	0.15μF	±10%	GCG188L81C154KA01#	
			0.22μF	±10%	GCG188L81C224KA01#	
			X8R	68000pF	±10%	GCG188R91C683KA01#
				0.33μF	±10%	GCG188R91E334KA01#
				0.39μF	±10%	GCG188R91E394KA01#
				0.47μF	±10%	GCG188R91E474KA01#
		X7R		0.12μF	±10%	GCG188R71E124KA12#
				0.15μF	±10%	GCG188R71E154KA12#
			0.18μF	±10%	GCG188R71E184KA12#	
			0.22μF	±10%	GCG188R71E224KA12#	
			0.10μF	±10%	GCG188R91C104KA01#	

T max.	Rated Voltage	TC Code	Cap.	Tol.	Part Number	
0.95mm	50Vdc	X8R	22000pF	±10%	GCG219R91H223KA03#	
			10000pF	±10%	GCG219R91E103KA01#	
			15000pF	±10%	GCG219R91E153KA01#	
	1.45mm	50Vdc	X8L	27000pF	±10%	GCG21BL81H273KA01#
				33000pF	±10%	GCG21BL81H333KA01#
				39000pF	±10%	GCG21BL81H393KA01#
47000pF				±10%	GCG21BL81H473KA01#	
0.10μF				±10%	GCG21BL81H104KA03#	
X8R				33000pF	±10%	GCG21BR91H333KA03#
		47000pF	±10%	GCG21BR91H473KA03#		
		56000pF	±10%	GCG21BR91H563KA03#		
		68000pF	±10%	GCG21BR91H683KA03#		
		0.10μF	±10%	GCG21BR91H104KA03#		
		X7R	0.15μF	±10%	GCG21BR71H154KA01#	
0.18μF			±10%	GCG21BR71H184KA01#		
0.22μF	±10%		GCG21BR71H224KA01#			
25Vdc	X8L		0.10μF	±10%	GCG21BL81E104KA01#	
			0.33μF	±10%	GCG21BL81E334KA01#	
			X8R	33000pF	±10%	GCG21BR91E333KA01#
	39000pF	±10%		GCG21BR91E393KA01#		
	47000pF	±10%		GCG21BR91E473KA01#		
	16Vdc	X8L	82000pF	±10%	GCG21BR91E823KA01#	
0.10μF			±10%	GCG21BR91E104KA01#		
0.15μF			±10%	GCG21BR91E154KA03#		
0.18μF			±10%	GCG21BR91E184KA03#		
0.22μF			±10%	GCG21BR91E224KA03#		
X7R			0.27μF	±10%	GCG21BR71E274KA01#	
		0.33μF	±10%	GCG21BR71E334KA01#		
		0.39μF	±10%	GCG21BR71E394KA01#		
		0.47μF	±10%	GCG21BR71E474KA01#		
		0.56μF	±10%	GCG21BR71E564KA01#		
		0.68μF	±10%	GCG21BR71E684KA01#		
X8L		0.82μF	±10%	GCG21BR71E824KA01#		
	1.0μF	±10%	GCG21BR71E105KA12#			
	0.33μF	±10%	GCG21BL81C334KA01#			
		0.39μF	±10%	GCG21BL81C394KA01#		
		0.47μF	±10%	GCG21BL81C474KA01#		
		0.56μF	±10%	GCG21BL81C564KA01#		
0.68μF		±10%	GCG21BL81C684KA01#			
0.82μF		±10%	GCG21BL81C824KA01#			
X7R	4.7μF	±10%	GCG21BR71C475KA12#			

■ 3.2x1.6mm

T max.	Rated Voltage	TC Code	Cap.	Tol.	Part Number
1.35mm	50Vdc	X8R	0.15μF	±10%	GCG31MR91H154KA03#
			0.22μF	±10%	GCG31MR91H224KA03#
			0.33μF	±10%	GCG31MR91H334KA03#
	25Vdc	X8R	0.15μF	±10%	GCG31MR91E154KA01#
			0.22μF	±10%	GCG31MR91E224KA01#
			0.33μF	±10%	GCG31MR91E334KA01#
X7R	1.0μF	±10%	GCG31MR71E105KA01#		

■ 2.0x1.25mm

T max.	Rated Voltage	TC Code	Cap.	Tol.	Part Number
0.95mm	50Vdc	X8R	10000pF	±10%	GCG219R91H103KA03#
			15000pF	±10%	GCG219R91H153KA03#
			18000pF	±10%	GCG219R91H183KA03#

Part number # indicates the package specification code.

# GCG Series High Dielectric Constant Type AEC-Q200 Defecting crack Soldering crack Part Number List

(→ ■ 3.2x1.6mm)

T max.	Rated Voltage	TC Code	Cap.	Tol.	Part Number
1.35mm	25Vdc	X7R	1.2μF	±10%	<b>GCG31MR71E125KA01#</b>
			1.5μF	±10%	<b>GCG31MR71E155KA01#</b>
			2.2μF	±10%	<b>GCG31MR71E225KA12#</b>
	16Vdc	X8L	1.0μF	±10%	<b>GCG31ML81C105KA01#</b>
			1.5μF	±10%	<b>GCG31ML81C155KA01#</b>
1.9mm	25Vdc	X8R	0.68μF	±10%	<b>GCG31CR91E684KA03#</b>
			3.3μF	±10%	<b>GCG31CR71E335KA01#</b>
		X7R	3.9μF	±10%	<b>GCG31CR71E395KA01#</b>
			4.7μF	±10%	<b>GCG31CR71E475KA01#</b>
	16Vdc	X8L	3.3μF	±10%	<b>GCG31CL81C335KA01#</b>
			4.7μF	±10%	<b>GCG31CL81C475KA01#</b>
		X8R	0.68μF	±10%	<b>GCG31CR91C684KA01#</b>
			1.0μF	±10%	<b>GCG31CR91C105KA01#</b>

■ 3.2x2.5mm

T max.	Rated Voltage	TC Code	Cap.	Tol.	Part Number
2.3mm	25Vdc	X7R	3.3μF	±10%	<b>GCG32DR71E335KA01#</b>
2.8mm	25Vdc	X7R	4.7μF	±10%	<b>GCG32ER71E475KA01#</b>
			10μF	±10%	<b>GCG32ER71E106KA12#</b>

GCM Series

GCD Series

GCE Series

GCG Series

GCJ Series

GC3 Series

KCM Series

KC3 Series

⚠Caution/Notice

Resin External Electrode Product

**GCJ Series**



The resin external electrodes prevent the occurrence of cracking caused by deflection stress after board mounting!

Features

1 The resin external electrodes suppress cracks by board deflection.

Cracking of the ceramic element is suppressed by the resin of the external electrodes, which releases the stress.

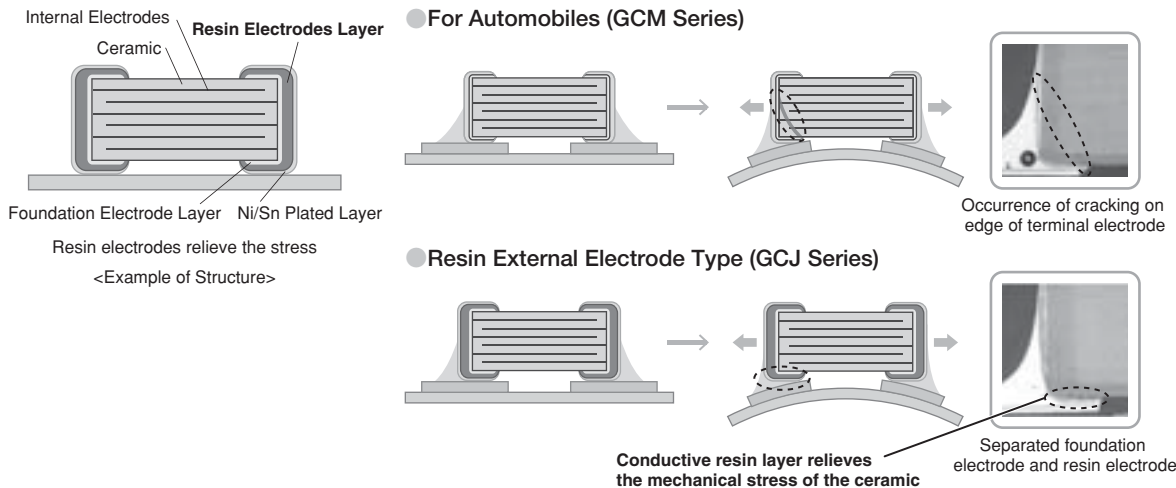

2 Suppresses the occurrence of cracking caused by deflection stress at the time of board mounting, etc.

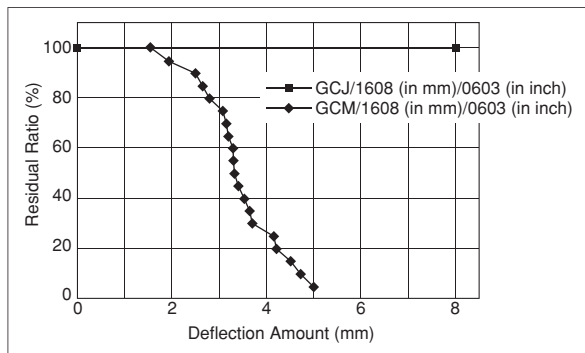

Due to the specification of the measuring instrument, measurements can be performed up to 8mm.

3 Ideal for automobiles.

This AEC-Q200 conforming product is ideal for the ECU, control circuits of headlights, etc. of automobiles.

Specifications

Size	1.6×0.8mm to 5.7×5.0mm
Rated Voltage	6.3Vdc to 1kVdc
Capacitance	220pF to 47μF
Main Applications	Battery lines and power trains for automobiles

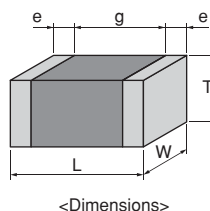

# GCJ Series High Dielectric Constant Type AEC-Q200 Fail safe Deflecting crack Part Number List

## ■ 1.6x0.8mm

T max.	Rated Voltage	TC Code	Cap.	Tol.	Part Number		
0.9mm	100Vdc	X8R	1000pF	±10%	GCJ188R92A102KA01#		
			1200pF	±10%	GCJ188R92A122KA01#		
			1500pF	±10%	GCJ188R92A152KA01#		
			1800pF	±10%	GCJ188R92A182KA01#		
			2200pF	±10%	GCJ188R92A222KA01#		
			2700pF	±10%	GCJ188R92A272KA01#		
			3300pF	±10%	GCJ188R92A332KA01#		
			3900pF	±10%	GCJ188R92A392KA01#		
			4700pF	±10%	GCJ188R92A472KA01#		
			5600pF	±10%	GCJ188R92A562KA01#		
			6800pF	±10%	GCJ188R92A682KA01#		
			8200pF	±10%	GCJ188R92A822KA01#		
			10000pF	±10%	GCJ188R92A103KA01#		
			12000pF	±10%	GCJ188R92A123KA01#		
			15000pF	±10%	GCJ188R92A153KA01#		
			18000pF	±10%	GCJ188R92A183KA01#		
			22000pF	±10%	GCJ188R92A223KA01#		
			27000pF	±10%	GCJ188R92A273KA01#		
			33000pF	±10%	GCJ188R92A333KA01#		
			39000pF	±10%	GCJ188R92A393KA01#		
			47000pF	±10%	GCJ188R92A473KA01#		
			56000pF	±10%	GCJ188R92A563KA01#		
			68000pF	±10%	GCJ188R92A683KA01#		
			X7R	1000pF	±10%	GCJ188R72A102KA01#	
		1200pF		±10%	GCJ188R72A122KA01#		
		1500pF		±10%	GCJ188R72A152KA01#		
		1800pF		±10%	GCJ188R72A182KA01#		
		2200pF		±10%	GCJ188R72A222KA01#		
		2700pF		±10%	GCJ188R72A272KA01#		
		3300pF		±10%	GCJ188R72A332KA01#		
		3900pF		±10%	GCJ188R72A392KA01#		
		4700pF		±10%	GCJ188R72A472KA01#		
		5600pF		±10%	GCJ188R72A562KA01#		
		6800pF		±10%	GCJ188R72A682KA01#		
		8200pF		±10%	GCJ188R72A822KA01#		
		10000pF		±10%	GCJ188R72A103KA01#		
		12000pF		±10%	GCJ188R72A123KA01#		
		15000pF		±10%	GCJ188R72A153KA01#		
		18000pF		±10%	GCJ188R72A183KA01#		
		22000pF		±10%	GCJ188R72A223KA01#		
		0.10μF		±10%	GCJ188R72A104KA01#		
		50Vdc		X8L	1000pF	±10%	GCJ188L81H102KA01#
					1200pF	±10%	GCJ188L81H122KA01#
					1500pF	±10%	GCJ188L81H152KA01#
					1800pF	±10%	GCJ188L81H182KA01#
					2200pF	±10%	GCJ188L81H222KA01#
					2700pF	±10%	GCJ188L81H272KA01#
			3300pF		±10%	GCJ188L81H332KA01#	
	3900pF		±10%		GCJ188L81H392KA01#		
	X8R		4700pF	±10%	GCJ188L81H472KA01#		
			5600pF	±10%	GCJ188L81H562KA01#		
			6800pF	±10%	GCJ188L81H682KA01#		

T max.	Rated Voltage	TC Code	Cap.	Tol.	Part Number		
0.9mm	50Vdc	X8L	8200pF	±10%	GCJ188L81H822KA01#		
			10000pF	±10%	GCJ188L81H103KA01#		
			12000pF	±10%	GCJ188L81H123KA01#		
			15000pF	±10%	GCJ188L81H153KA01#		
			18000pF	±10%	GCJ188L81H183KA01#		
			22000pF	±10%	GCJ188L81H223KA01#		
			X8R	4700pF	±10%	GCJ188R91H472KA01#	
				10000pF	±10%	GCJ188R91H103KA01#	
				0.10μF	±10%	GCJ188R91H104KA01#	
				0.12μF	±10%	GCJ188R91H124KA01#	
				0.15μF	±10%	GCJ188R91H154KA01#	
				0.18μF	±10%	GCJ188R91H184KA01#	
				0.22μF	±10%	GCJ188R91H224KA01#	
				X7R	1000pF	±10%	GCJ188R71H102KA01#
					1200pF	±10%	GCJ188R71H122KA01#
					1500pF	±10%	GCJ188R71H152KA01#
					1800pF	±10%	GCJ188R71H182KA01#
					2200pF	±10%	GCJ188R71H222KA01#
			2700pF		±10%	GCJ188R71H272KA01#	
			3300pF		±10%	GCJ188R71H332KA01#	
			3900pF		±10%	GCJ188R71H392KA01#	
			4700pF		±10%	GCJ188R71H472KA01#	
			5600pF		±10%	GCJ188R71H562KA01#	
			6800pF		±10%	GCJ188R71H682KA01#	
		8200pF	±10%		GCJ188R71H822KA01#		
		10000pF	±10%		GCJ188R71H103KA01#		
		12000pF	±10%		GCJ188R71H123KA01#		
		15000pF	±10%		GCJ188R71H153KA01#		
		18000pF	±10%		GCJ188R71H183KA01#		
		22000pF	±10%		GCJ188R71H223KA01#		
		33000pF	±10%		GCJ188R71H333KA12#		
		39000pF	±10%		GCJ188R71H393KA12#		
		47000pF	±10%		GCJ188R71H473KA12#		
		56000pF	±10%		GCJ188R71H563KA12#		
		68000pF	±10%		GCJ188R71H683KA12#		
		82000pF	±10%		GCJ188R71H823KA12#		
		35Vdc	X8L		0.10μF	±10%	GCJ188R71H104KA12#
				0.15μF	±10%	GCJ188R71H154KA01#	
				0.22μF	±10%	GCJ188R71H224KA01#	
				33000pF	±10%	GCJ188L8YA333KA01#	
				39000pF	±10%	GCJ188L8YA393KA01#	
				56000pF	±10%	GCJ188L8YA563KA01#	
				68000pF	±10%	GCJ188L8YA683KA01#	
				25Vdc	X8L	33000pF	±10%
		39000pF	±10%			GCJ188L81E393KA01#	
		56000pF	±10%			GCJ188L81E563KA01#	
		68000pF	±10%			GCJ188L81E683KA01#	
		82000pF	±10%			GCJ188L81E823KA01#	
	0.15μF	±10%	GCJ188L81E154KA01#				
	0.18μF	±10%	GCJ188L81E184KA01#				
	0.22μF	±10%	GCJ188L81E224KA01#				
	X8R	0.33μF	±10%		GCJ188R91E334KA01#		
0.39μF		±10%	GCJ188R91E394KA01#				
0.47μF		±10%	GCJ188R91E474KA01#				

GCM Series

GCD Series

GCE Series

GCG Series

GCJ Series

GC3 Series

KCM Series

KC3 Series

⚠Caution/Notice

Part number # indicates the package specification code.

# GCJ Series High Dielectric Constant Type AEC-Q200 Fail safe Deflecting crack Part Number List

(→ ■ 1.6x0.8mm)

T max.	Rated Voltage	TC Code	Cap.	Tol.	Part Number	
0.9mm	25Vdc	X7R	1000pF	±10%	GCJ188R71E102KA01#	
			1200pF	±10%	GCJ188R71E122KA01#	
			1500pF	±10%	GCJ188R71E152KA01#	
			1800pF	±10%	GCJ188R71E182KA01#	
			2200pF	±10%	GCJ188R71E222KA01#	
			2700pF	±10%	GCJ188R71E272KA01#	
			3300pF	±10%	GCJ188R71E332KA01#	
			3900pF	±10%	GCJ188R71E392KA01#	
			4700pF	±10%	GCJ188R71E472KA01#	
			5600pF	±10%	GCJ188R71E562KA01#	
			6800pF	±10%	GCJ188R71E682KA01#	
			8200pF	±10%	GCJ188R71E822KA01#	
		10000pF	±10%	GCJ188R71E103KA01#		
		12000pF	±10%	GCJ188R71E123KA01#		
		15000pF	±10%	GCJ188R71E153KA01#		
		18000pF	±10%	GCJ188R71E183KA01#		
		22000pF	±10%	GCJ188R71E223KA01#		
		27000pF	±10%	GCJ188R71E273KA01#		
		33000pF	±10%	GCJ188R71E333KA01#		
		39000pF	±10%	GCJ188R71E393KA01#		
		47000pF	±10%	GCJ188R71E473KA01#		
		56000pF	±10%	GCJ188R71E563KA12#		
		68000pF	±10%	GCJ188R71E683KA12#		
		82000pF	±10%	GCJ188R71E823KA12#		
		0.10μF	±10%	GCJ188R71E104KA12#		
		0.12μF	±10%	GCJ188R71E124KA01#		
		0.15μF	±10%	GCJ188R71E154KA01#		
		0.18μF	±10%	GCJ188R71E184KA12#		
		0.22μF	±10%	GCJ188R71E224KA12#		
		1.0μF	±10%	GCJ188R71E105KA01#		
		16Vdc	X8L	33000pF	±10%	GCJ188L81C333KA01#
				39000pF	±10%	GCJ188L81C393KA01#
				47000pF	±10%	GCJ188L81C473KA01#
				56000pF	±10%	GCJ188L81C563KA01#
				68000pF	±10%	GCJ188L81C683KA01#
				82000pF	±10%	GCJ188L81C823KA01#
0.10μF	±10%			GCJ188L81C104KA01#		
0.12μF	±10%			GCJ188L81C124KA01#		
0.15μF	±10%			GCJ188L81C154KA01#		
0.18μF	±10%			GCJ188L81C184KA01#		
0.22μF	±10%			GCJ188L81C224KA01#		
X7R	10000pF			±10%	GCJ188R71C103KA01#	
	27000pF		±10%	GCJ188R71C273KA01#		
	33000pF		±10%	GCJ188R71C333KA01#		
	39000pF		±10%	GCJ188R71C393KA01#		
	47000pF		±10%	GCJ188R71C473KA01#		
	56000pF		±10%	GCJ188R71C563KA01#		
	68000pF		±10%	GCJ188R71C683KA01#		
	82000pF		±10%	GCJ188R71C823KA01#		
	0.10μF		±10%	GCJ188R71C104KA01#		
	0.12μF		±10%	GCJ188R71C124KA01#		
	0.15μF		±10%	GCJ188R71C154KA01#		
	0.18μF		±10%	GCJ188R71C184KA01#		
0.22μF	±10%		GCJ188R71C224KA01#			

T max.	Rated Voltage	TC Code	Cap.	Tol.	Part Number
0.9mm	16Vdc	X7R	0.27μF	±10%	GCJ188R71C274KA01#
			0.33μF	±10%	GCJ188R71C334KA01#
			0.39μF	±10%	GCJ188R71C394KA12#
			0.47μF	±10%	GCJ188R71C474KA12#
	10Vdc	X7R	0.12μF	±10%	GCJ188R71A124KA01#
			0.15μF	±10%	GCJ188R71A154KA01#
			0.18μF	±10%	GCJ188R71A184KA01#
			0.22μF	±10%	GCJ188R71A224KA01#
	6.3Vdc	X7R	2.2μF	±10%	GCJ188R70J225KE01#

■ 2.0x1.25mm

T max.	Rated Voltage	TC Code	Cap.	Tol.	Part Number	
0.7mm	100Vdc	X7R	1000pF	±10%	GCJ216R72A102KA01#	
			1200pF	±10%	GCJ216R72A122KA01#	
			1500pF	±10%	GCJ216R72A152KA01#	
			1800pF	±10%	GCJ216R72A182KA01#	
			2200pF	±10%	GCJ216R72A222KA01#	
			2700pF	±10%	GCJ216R72A272KA01#	
			3300pF	±10%	GCJ216R72A332KA01#	
			3900pF	±10%	GCJ216R72A392KA01#	
			4700pF	±10%	GCJ216R72A472KA01#	
			5600pF	±10%	GCJ216R72A562KA01#	
			6800pF	±10%	GCJ216R72A682KA01#	
			8200pF	±10%	GCJ216R72A822KA01#	
		10000pF	±10%	GCJ216R72A103KA01#		
		12000pF	±10%	GCJ216R72A123KA01#		
		15000pF	±10%	GCJ216R72A153KA01#		
		18000pF	±10%	GCJ216R72A183KA01#		
		22000pF	±10%	GCJ216R72A223KA01#		
		50Vdc	X7R	330pF	±10%	GCJ216R71H331KA01#
				390pF	±10%	GCJ216R71H391KA01#
				470pF	±10%	GCJ216R71H471KA01#
				560pF	±10%	GCJ216R71H561KA01#
				680pF	±10%	GCJ216R71H681KA01#
				820pF	±10%	GCJ216R71H821KA01#
				1000pF	±10%	GCJ216R71H102KA01#
1200pF	±10%			GCJ216R71H122KA01#		
1500pF	±10%			GCJ216R71H152KA01#		
1800pF	±10%			GCJ216R71H182KA01#		
2200pF	±10%			GCJ216R71H222KA01#		
2700pF	±10%			GCJ216R71H272KA01#		
3300pF	±10%	GCJ216R71H332KA01#				
3900pF	±10%	GCJ216R71H392KA01#				
4700pF	±10%	GCJ216R71H472KA01#				
5600pF	±10%	GCJ216R71H562KA01#				
6800pF	±10%	GCJ216R71H682KA01#				
8200pF	±10%	GCJ216R71H822KA01#				
10000pF	±10%	GCJ216R71H103KA01#				
12000pF	±10%	GCJ216R71H123KA01#				
15000pF	±10%	GCJ216R71H153KA01#				
18000pF	±10%	GCJ216R71H183KA01#				
22000pF	±10%	GCJ216R71H223KA01#				

Part number # indicates the package specification code.

GCM Series  
 GCD Series  
 GCE Series  
 GCG Series  
 GCJ Series  
 GC3 Series  
 KCM Series  
 KC3 Series  
 ⚠Caution/Notice

# GCJ Series High Dielectric Constant Type AEC-Q200 Fail safe Deflecting crack Part Number List

(→ ■ 2.0x1.25mm)

T max.	Rated Voltage	TC Code	Cap.	Tol.	Part Number	T max.	Rated Voltage	TC Code	Cap.	Tol.	Part Number			
0.7mm	25Vdc	X7R	470pF	±10%	GCJ216R71E471KA01#	1.45mm	100Vdc	X7R	0.10μF	±10%	GCJ21BR72A104KA01#			
			560pF	±10%	GCJ216R71E561KA01#				50Vdc	X8L	27000pF	±10%	GCJ21BL81H273KA01#	
			680pF	±10%	GCJ216R71E681KA01#						33000pF	±10%	GCJ21BL81H333KA01#	
			820pF	±10%	GCJ216R71E821KA01#						39000pF	±10%	GCJ21BL81H393KA01#	
			1000pF	±10%	GCJ216R71E102KA01#						47000pF	±10%	GCJ21BL81H473KA01#	
			1200pF	±10%	GCJ216R71E122KA01#						56000pF	±10%	GCJ21BL81H563KA01#	
			1500pF	±10%	GCJ216R71E152KA01#						68000pF	±10%	GCJ21BL81H683KA01#	
			1800pF	±10%	GCJ216R71E182KA01#						82000pF	±10%	GCJ21BL81H823KA01#	
			2200pF	±10%	GCJ216R71E222KA01#						0.10μF	±10%	GCJ21BL81H104KA01#	
			2700pF	±10%	GCJ216R71E272KA01#						X7R	47000pF	±10%	GCJ21BR71H473KA01#
			3300pF	±10%	GCJ216R71E332KA01#		56000pF	±10%				GCJ21BR71H563KA01#		
			3900pF	±10%	GCJ216R71E392KA01#		68000pF	±10%	GCJ21BR71H683KA01#					
			4700pF	±10%	GCJ216R71E472KA01#		82000pF	±10%	GCJ21BR71H823KA01#					
			5600pF	±10%	GCJ216R71E562KA01#		0.10μF	±10%	GCJ21BR71H104KA01#					
			6800pF	±10%	GCJ216R71E682KA01#		0.12μF	±10%	GCJ21BR71H124KA01#					
			8200pF	±10%	GCJ216R71E822KA01#		0.15μF	±10%	GCJ21BR71H154KA01#					
			10000pF	±10%	GCJ216R71E103KA01#		0.18μF	±10%	GCJ21BR71H184KA01#					
			12000pF	±10%	GCJ216R71E123KA01#		0.22μF	±10%	GCJ21BR71H224KA01#					
			0.95mm	100Vdc	X7R		220pF	±10%	GCJ219R72A221KA01#	35Vdc		X8L	0.12μF	±10%
			270pF				±10%	GCJ219R72A271KA01#	0.15μF		±10%		GCJ21BL8YA154KA01#	
330pF	±10%	GCJ219R72A331KA01#	0.18μF			±10%	GCJ21BL8YA184KA01#							
390pF	±10%	GCJ219R72A391KA01#	0.22μF			±10%	GCJ21BL8YA224KA01#							
470pF	±10%	GCJ219R72A471KA01#	0.33μF			±10%	GCJ21BL8YA334KA01#							
560pF	±10%	GCJ219R72A561KA01#	0.47μF			±10%	GCJ21BL8YA474KA01#							
680pF	±10%	GCJ219R72A681KA01#	25Vdc			X8L	0.12μF	±10%	GCJ21BL81E124KA01#					
820pF	±10%	GCJ219R72A821KA01#					0.15μF	±10%	GCJ21BL81E154KA01#					
27000pF	±10%	GCJ219R72A273KA01#					0.18μF	±10%	GCJ21BL81E184KA01#					
33000pF	±10%	GCJ219R72A333KA01#					0.22μF	±10%	GCJ21BL81E224KA01#					
39000pF	±10%	GCJ219R72A393KA01#		0.27μF	±10%		GCJ21BL81E274KA01#							
50Vdc	X7R	27000pF		±10%	GCJ219R71H273KA01#		0.33μF	±10%	GCJ21BL81E334KA01#					
33000pF		±10%		GCJ219R71H333KA01#	0.39μF		±10%	GCJ21BL81E394KA01#						
39000pF		±10%		GCJ219R71H393KA01#	0.47μF		±10%	GCJ21BL81E474KA01#						
0.33μF		±10%		GCJ219R71H334KA12#	0.68μF		±10%	GCJ21BL81E684KA01#						
25Vdc	X7R	15000pF		±10%	GCJ219R71E153KA01#		0.82μF	±10%	GCJ21BL81E824KA01#					
		18000pF	±10%	GCJ219R71E183KA01#	1.0μF	±10%	GCJ21BL81E105KA01#							
		22000pF	±10%	GCJ219R71E223KA01#	X7R	27000pF	±10%	GCJ21BR71E273KA01#						
		0.33μF	±10%	GCJ219R71E334KA01#		33000pF	±10%	GCJ21BR71E333KA01#						
		0.47μF	±10%	GCJ219R71E474KA12#		39000pF	±10%	GCJ21BR71E393KA01#						
		16Vdc	X7R	0.68μF		±10%	GCJ219R71C684KA01#	47000pF	±10%	GCJ21BR71E473KA01#				
0.82μF	±10%	GCJ219R71C824KA01#		56000pF		±10%	GCJ21BR71E563KA01#							
1.0μF	±10%	GCJ219R71C105KA01#		68000pF		±10%	GCJ21BR71E683KA01#							
1.0mm	250Vdc	X7R	1000pF	±10%	GCJ21AR72E102KXJ1#	82000pF	±10%	GCJ21BR71E823KA01#						
			1500pF	±10%	GCJ21AR72E152KXJ1#	0.10μF	±10%	GCJ21BR71E104KA01#						
			2200pF	±10%	GCJ21AR72E222KXJ1#	0.27μF	±10%	GCJ21BR71E274KA01#						
			3300pF	±10%	GCJ21AR72E332KXJ1#	0.39μF	±10%	GCJ21BR71E394KA01#						
			4700pF	±10%	GCJ21AR72E472KXJ1#	0.56μF	±10%	GCJ21BR71E564KA12#						
			6800pF	±10%	GCJ21AR72E682KXJ1#	0.68μF	±10%	GCJ21BR71E684KA12#						
			1.45mm	250Vdc	X7R	10000pF	±10%	GCJ21BR72E103KXJ3#	0.82μF	±10%	GCJ21BR71E824KA12#			
15000pF	±10%	GCJ21BR72E153KXJ3#	1.0μF			±10%	GCJ21BR71E105KA12#							
22000pF	±10%	GCJ21BR72E223KXJ3#	1.5μF			±10%	GCJ21BR71E155KA01#							
100Vdc	X7R	47000pF	±10%	GCJ21BR72A473KA01#	2.2μF	±10%	GCJ21BR71E225KA01#							
		56000pF	±10%	GCJ21BR72A563KA01#	16Vdc	X8L	0.56μF	±10%	GCJ21BL81C564KA01#					
		68000pF	±10%	GCJ21BR72A683KA01#										
		82000pF	±10%	GCJ21BR72A823KA01#										

GCM Series  
 GCD Series  
 GCE Series  
 GCG Series  
 GCJ Series  
 GCG3 Series  
 KCM Series  
 KC3 Series  
 ⚠Caution/Notice

Part number # indicates the package specification code.

# GCJ Series High Dielectric Constant Type AEC-Q200 Fail safe Defecting crack Part Number List

(→ ■ 2.0x1.25mm)

T max.	Rated Voltage	TC Code	Cap.	Tol.	Part Number
1.45mm	16Vdc	X8L	0.68μF	±10%	GCJ21BL81C684KA01#
			0.82μF	±10%	GCJ21BL81C824KA01#
			1.0μF	±10%	GCJ21BL81C105KA01#
		X7R	0.27μF	±10%	GCJ21BR71C274KA01#
			0.33μF	±10%	GCJ21BR71C334KA01#
			0.39μF	±10%	GCJ21BR71C394KA01#
			0.47μF	±10%	GCJ21BR71C474KA01#
	10Vdc	X7R	0.56μF	±10%	GCJ21BR71C564KA01#
			1.0μF	±10%	GCJ21BR71C105KA01#
			2.2μF	±10%	GCJ21BR71C225KA13#
	10Vdc	X7R	4.7μF	±10%	GCJ21BR71C475KA01#
			2.2μF	±10%	GCJ21BR71A225KA01#
			10μF	±10%	GCJ21BR71A106KE01#

■ 3.2x1.6mm

T max.	Rated Voltage	TC Code	Cap.	Tol.	Part Number			
0.95mm	100Vdc	X7R	0.10μF	±10%	GCJ319R72A104KA01#			
	50Vdc	X7R	0.10μF	±10%	GCJ319R71H104KA01#			
			0.12μF	±10%	GCJ319R71H124KA01#			
1.25mm	1000Vdc	X7R	1000pF	±10%	GCJ31BR73A102KXJ1#			
			1500pF	±10%	GCJ31BR73A152KXJ1#			
			2200pF	±10%	GCJ31BR73A222KXJ1#			
			3300pF	±10%	GCJ31BR73A332KXJ1#			
			4700pF	±10%	GCJ31BR73A472KXJ1#			
			630Vdc	X7R	1000pF	±10%	GCJ31BR72J102KXJ1#	
	1500pF	±10%	GCJ31BR72J152KXJ1#					
	2200pF	±10%	GCJ31BR72J222KXJ1#					
	3300pF	±10%	GCJ31BR72J332KXJ1#					
	4700pF	±10%	GCJ31BR72J472KXJ1#					
	6800pF	±10%	GCJ31BR72J682KXJ1#					
	250Vdc	X7R	10000pF	±10%	GCJ31BR72J103KXJ1#			
			15000pF	±10%	GCJ31BR72E153KXJ1#			
			22000pF	±10%	GCJ31BR72E223KXJ1#			
			68000pF	±10%	GCJ31BR72E683KXJ1#			
			1.35mm	100Vdc	X7R	0.15μF	±10%	GCJ31MR72A154KA01#
			0.18μF			±10%	GCJ31MR72A184KA01#	
	0.22μF	±10%	GCJ31MR72A224KA01#					
1.35mm	50Vdc	X7R	0.15μF	±10%	GCJ31MR71H154KA01#			
			0.18μF	±10%	GCJ31MR71H184KA01#			
			0.22μF	±10%	GCJ31MR71H224KA01#			
			0.27μF	±10%	GCJ31MR71H274KA01#			
			0.33μF	±10%	GCJ31MR71H334KA01#			
			0.39μF	±10%	GCJ31MR71H394KA01#			
	25Vdc	X7R	0.47μF	±10%	GCJ31MR71H474KA01#			
			0.56μF	±10%	GCJ31MR71H564KA12#			
			0.68μF	±10%	GCJ31MR71H684KA12#			
			0.82μF	±10%	GCJ31MR71H824KA12#			
			1.0μF	±10%	GCJ31MR71H105KA12#			
			0.10μF	±10%	GCJ31MR71E104KA01#			
25Vdc	X7R	0.12μF	±10%	GCJ31MR71E124KA01#				
		0.15μF	±10%	GCJ31MR71E154KA01#				
		0.18μF	±10%	GCJ31MR71E184KA01#				

T max.	Rated Voltage	TC Code	Cap.	Tol.	Part Number			
1.35mm	25Vdc	X7R	0.22μF	±10%	GCJ31MR71E224KA01#			
			1.0μF	±10%	GCJ31MR71E105KA01#			
			1.5μF	±10%	GCJ31MR71E155KA12#			
			2.2μF	±10%	GCJ31MR71E225KA12#			
			3.3μF	±10%	GCJ31MR71E335KA12#			
	16Vdc	X7R	1.0μF	±10%	GCJ31MR71C105KA01#			
			1.5μF	±10%	GCJ31MR71C155KA01#			
			1.8mm	1000Vdc	X7R	6800pF	±10%	GCJ31CR73A682KXJ3#
			10000pF			±10%	GCJ31CR73A103KXJ3#	
			630Vdc			X7R	15000pF	±10%
22000pF	±10%	GCJ31CR72J223KXJ3#						
250Vdc	X7R	33000pF	±10%	GCJ31CR72E333KXJ3#				
47000pF		±10%	GCJ31CR72E473KXJ3#					
0.10μF		±10%	GCJ31CR72E104KXJ3#					
1.9mm	100Vdc	X7R	1.0μF	±10%	GCJ31CR72A105KA01#			
			50Vdc	X7R	1.5μF	±10%	GCJ31CR71H155KA12#	
					2.2μF	±10%	GCJ31CR71H225KA12#	
	35Vdc	X8L	4.7μF	±10%	GCJ31CC71H475KA01#			
			0.56μF	±10%	GCJ31CL8YA564KA01#			
			0.68μF	±10%	GCJ31CL8YA684KA01#			
			0.82μF	±10%	GCJ31CL8YA824KA01#			
	25Vdc	X8L	1.0μF	±10%	GCJ31CL8YA105KA01#			
			0.56μF	±10%	GCJ31CL81E564KA01#			
			0.68μF	±10%	GCJ31CL81E684KA01#			
0.82μF			±10%	GCJ31CL81E824KA01#				
1.0μF			±10%	GCJ31CL81E105KA01#				
16Vdc			X7R	4.7μF	±10%	GCJ31CR71E475KA12#		
X8L	3.3μF	±10%		GCJ31CL81C335KA01#				
	4.7μF	±10%		GCJ31CL81C475KA01#				
	10Vdc	X7R	3.3μF	±10%	GCJ31CR71C335KA01#			
4.7μF			±10%	GCJ31CR71C475KA01#				
10μF			±10%	GCJ31CR71C106KA15#				
10Vdc	X7R	6.8μF	±10%	GCJ31CR71A685KA13#				
		10μF	±10%	GCJ31CR71A106KA13#				
6.3Vdc	X7R	22μF	±10%	GCJ31CR70J226KE01#				
2.0mm	25Vdc	X7S	10μF	±10%	GCJ31CC71E106KA15#			

■ 3.2x2.5mm

T max.	Rated Voltage	TC Code	Cap.	Tol.	Part Number		
1.5mm	630Vdc	X7R	6800pF	±10%	GCJ32QR72J682KXJ1#		
			10000pF	±10%	GCJ32QR72J103KXJ1#		
	250Vdc	X7R	68000pF	±10%	GCJ32QR72E683KXJ1#		
0.15μF	±10%		GCJ32QR72E154KXJ1#				
2.0mm	1000Vdc	X7R	15000pF	±10%	GCJ32DR73A153KXJ1#		
			22000pF	±10%	GCJ32DR73A223KXJ1#		
			630Vdc	X7R	15000pF	±10%	GCJ32DR72J153KXJ1#
			22000pF		±10%	GCJ32DR72J223KXJ1#	
	33000pF	±10%	GCJ32DR72J333KXJ1#				
	250Vdc	X7R	47000pF	±10%	GCJ32DR72J473KXJ1#		
			0.10μF	±10%	GCJ32DR72E104KXJ1#		
			0.22μF	±10%	GCJ32DR72E224KXJ1#		
	2.3mm	100Vdc	X7R	2.2μF	±10%	GCJ32DR72A225KA01#	

Part number # indicates the package specification code.



# GCJ Series High Dielectric Constant Type AEC-Q200 Fail safe Deflecting crack Part Number List

(→ ■ 3.2×2.5mm)

T max.	Rated Voltage	TC Code	Cap.	Tol.	Part Number
2.8mm	50Vdc	X7R	4.7μF	±10%	GCJ32ER71H475KA12#
		X7S	10μF	±10%	GCJ32EC71H106KA01#
	25Vdc	X8L	4.7μF	±10%	GCJ32EL81E475KA01#
	16Vdc	X7R	22μF	±10%	GCJ32ER71C226KE01#
	6.3Vdc	X7R	47μF	±10%	GCJ32ER70J476KE01#

■ 4.5×3.2mm

T max.	Rated Voltage	TC Code	Cap.	Tol.	Part Number
1.5mm	630Vdc	X7R	68000pF	±10%	GCJ43QR72J683KXJ1#
	250Vdc	X7R	0.15μF	±10%	GCJ43QR72E154KXJ1#
2.0mm	1000Vdc	X7R	33000pF	±10%	GCJ43DR73A333KXJ1#
			47000pF	±10%	GCJ43DR73A473KXJ1#
	630Vdc	X7R	33000pF	±10%	GCJ43DR72J333KXJ1#
			47000pF	±10%	GCJ43DR72J473KXJ1#
			0.10μF	±10%	GCJ43DR72J104KXJ1#
	250Vdc	X7R	0.22μF	±10%	GCJ43DR72E224KXJ1#
			0.33μF	±10%	GCJ43DR72E334KXJ1#
			0.47μF	±10%	GCJ43DR72E474KXJ1#

■ 5.7×5.0mm

T max.	Rated Voltage	TC Code	Cap.	Tol.	Part Number
2.0mm	1000Vdc	X7R	68000pF	±10%	GCJ55DR73A683KXJ1#
			0.10μF	±10%	GCJ55DR73A104KXJ1#
	630Vdc	X7R	0.10μF	±10%	GCJ55DR72J104KXJ1#
			0.15μF	±10%	GCJ55DR72J154KXJ1#
			0.22μF	±10%	GCJ55DR72J224KXJ1#
	250Vdc	X7R	0.33μF	±10%	GCJ55DR72E334KXJ1#
			0.47μF	±10%	GCJ55DR72E474KXJ1#
			0.68μF	±10%	GCJ55DR72E684KXJ1#
			1.0μF	±10%	GCJ55DR72E105KXJ1#

GCM Series

GCD Series

GCE Series

GCG Series

GCJ Series

GC3 Series

KCM Series

KC3 Series

⚠Caution/Notice

High Effective Capacitance & High Allowable Ripple Current

**GC3 Series**  **AEC-Q200** **Anti-noise**

This is a high ripple resistance product for automobiles, excellent in DC voltage characteristics.

Features

- 1 When a DC voltage is applied, a capacitance higher than conventional products (X7R characteristics) can be acquired.

When DC600V is applied, about twice the capacitance can be secured.

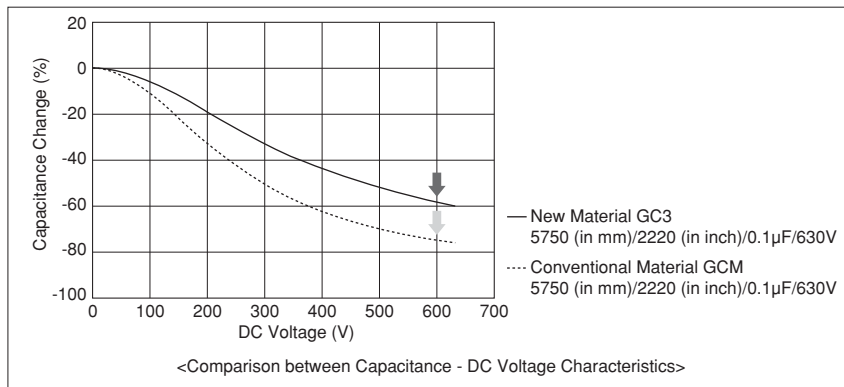

- 2 Improved ripple resistance performance compared to conventional products (X7R characteristics).

In the case of a product with a capacitance of 0.1μF, when the exothermic temperature reaches 20°C at frequency f=300kHz, the amount of resistance of a product with conventional material is 1.8Arms; however, the new material is 2.3 Arms.

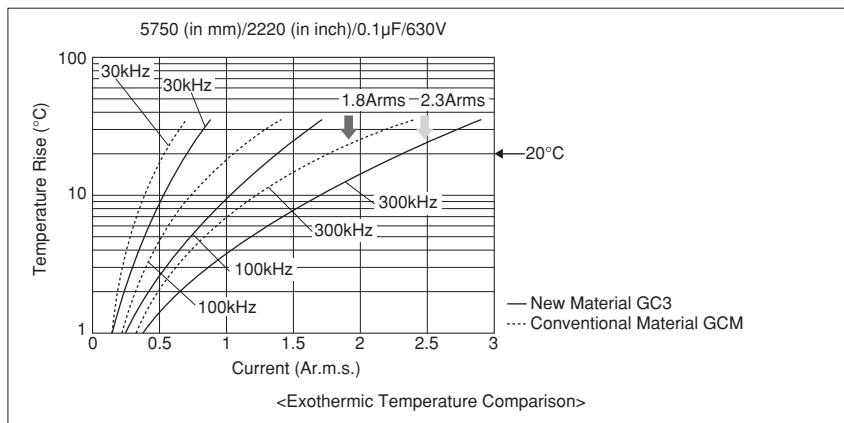

- 3 This product has a noise reduction effect.

Since dielectric materials that enable a reduction of noise are used, this product is more effective for reducing noise compared to the GCM series for automobiles.

Specifications

Size	2.0×1.25mm to 5.7×5.0mm
Rated Voltage	250Vdc to 630Vdc
Capacitance	10000pF to 1.0μF
Main Applications	For PFC (Power Factor Correction) circuits of power supplies, EMI suppression, and smoothing circuits of automobiles

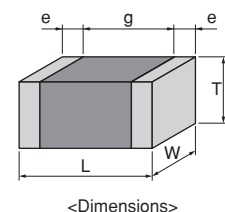

GCM Series  
 GCD Series  
 GCE Series  
 GCG Series  
 GCJ Series  
**GC3 Series**  
 KCM Series  
 KC3 Series  
 ⚠Caution/Notice

## GC3 Series High Dielectric Constant Type AEC-Q200 Anti-noise Part Number List

### ■ 2.0×1.25mm

T max.	Rated Voltage	TC Code	Cap.	Tol.	Part Number
1.0mm	250Vdc	X7T	10000pF	±10%	GC321AD72E103KX01#
			15000pF	±10%	GC321AD72E153KX01#
1.45mm	250Vdc	X7T	22000pF	±10%	GC321BD72E223KX03#

T max.	Rated Voltage	TC Code	Cap.	Tol.	Part Number
2.7mm	630Vdc	X7T	0.27μF	±10%	GC355XD72J274KX05#
	450Vdc	X7T	0.56μF	±10%	GC355XD72W564KX05#
	250Vdc	X7T	1.0μF	±10%	GC355XD72E105KX05#

### ■ 3.2×1.6mm

T max.	Rated Voltage	TC Code	Cap.	Tol.	Part Number
1.0mm	450Vdc	X7T	10000pF	±10%	GC331AD72W103KX01#
			15000pF	±10%	GC331AD72W153KX01#
	250Vdc	X7T	33000pF	±10%	GC331AD72E333KX01#
1.25mm	630Vdc	X7T	10000pF	±10%	GC331BD72J103KX01#
	450Vdc	X7T	22000pF	±10%	GC331BD72W223KX01#
			33000pF	±10%	GC331BD72W333KX01#
250Vdc	X7T	47000pF	±10%	GC331BD72E473KX01#	
1.8mm	630Vdc	X7T	15000pF	±10%	GC331CD72J153KX03#
	450Vdc	X7T	47000pF	±10%	GC331CD72W473KX03#
	250Vdc	X7T	68000pF	±10%	GC331CD72E683KX03#

### ■ 3.2×2.5mm

T max.	Rated Voltage	TC Code	Cap.	Tol.	Part Number
1.5mm	630Vdc	X7T	22000pF	±10%	GC332QD72J223KX01#
	250Vdc	X7T	0.10μF	±10%	GC332QD72E104KX01#
2.0mm	630Vdc	X7T	33000pF	±10%	GC332DD72J333KX01#
			47000pF	±10%	GC332DD72J473KX01#
	450Vdc	X7T	68000pF	±10%	GC332DD72W683KX01#
			0.10μF	±10%	GC332DD72W104KX01#
	250Vdc	X7T	0.15μF	±10%	GC332DD72E154KX01#

### ■ 4.5×3.2mm

T max.	Rated Voltage	TC Code	Cap.	Tol.	Part Number
1.5mm	250Vdc	X7T	0.22μF	±10%	GC343QD72E224KX01#
2.0mm	630Vdc	X7T	68000pF	±10%	GC343DD72J683KX01#
	450Vdc	X7T	0.15μF	±10%	GC343DD72W154KX01#
	250Vdc	X7T	0.33μF	±10%	GC343DD72E334KX01#

### ■ 5.7×5.0mm

T max.	Rated Voltage	TC Code	Cap.	Tol.	Part Number
2.0mm	630Vdc	X7T	0.10μF	±10%	GC355DD72J104KX01#
			0.15μF	±10%	GC355DD72J154KX01#
	450Vdc	X7T	0.22μF	±10%	GC355DD72W224KX01#
			0.33μF	±10%	GC355DD72W334KX01#
			0.47μF	±10%	GC355DD72W474KX01#
	250Vdc	X7T	0.47μF	±10%	GC355DD72E474KX01#
0.68μF			±10%	GC355DD72E684KX01#	
2.7mm	630Vdc	X7T	0.22μF	±10%	GC355XD72J224KX05#

Part number # indicates the package specification code.

Metal Terminal Type

# KCM Series



AEC-Q200

Anti-noise

Deflecting crack

Soldering crack

By bonding metal terminals to the external electrodes of the chip, the problem of how to design a capacitor to enable it to be mounted on a large MLCC has been solved!

## Features

### 1 Bond the metal terminals to the external electrodes of the chip.

The stress on the chip is reduced due to the elastic behavior of the metal terminals.

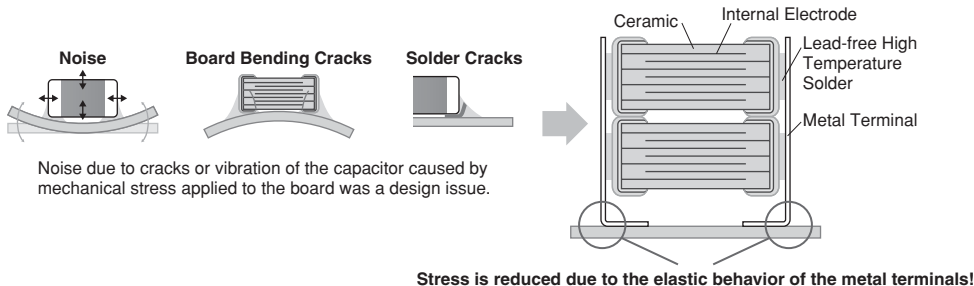

### 2 Noise, board deflection cracks, and solder cracks are greatly reduced.

No breakage occurs even when the board deflection is 6mm.  
 Solder cracks were not found even after 2000 heat stress cycles.

Comparison of Noise Reduction Effect

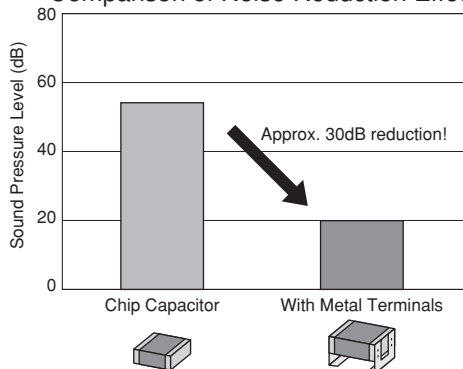

Evaluation Items: 2220 size/DC630V/220nF  
 Test Conditions: 50V, AC10Vp-p/3kHz  
 Sample Board: Glass-epoxy Board (T: 1.6mm)  
 Number of samples: 3  
 Distance between microphone and board: 3mm

Note: Results obtained using Murata's evaluation board

Stress caused by board deflection is reduced.

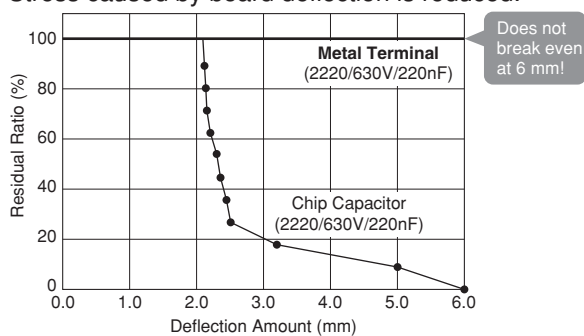

### Solder cracks due to heat stress are reduced.

Chip Size	Individual Chip (2220 size)	Metal Terminal (2220 size)
1000 cycles	 ↑Solder cracks	
2000 cycles	 ↑Solder cracks	

Compared to an individual chip, the addition of metal terminals results in excellent solder cracking resistance.

Test Conditions: -55 to +125°C, 5 minutes (liquid phase)  
 Board used: Glass-epoxy Board (FR-4)

GCM Series  
 GCD Series  
 GCE Series  
 GCG Series  
 GCJ Series  
 GC3 Series  
 KCM Series  
 KC3 Series  
 ⚠Caution/Notice

### ③ Chip Stacking

A large capacitance can be realized by stacking two capacitors on top of each other.

#### Specifications

Size	6.1×5.3mm
Rated Voltage	25Vdc to 100Vdc
Capacitance	4.7μF to 68μF
Main Applications	For drive control of engine ECU, etc. For other drive system control and safety equipment

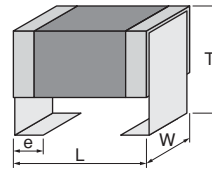

<Dimensions>

GCM Series

GCD Series

GCE Series

GCG Series

G CJ Series

GC3 Series

KCM Series

KC3 Series

△Caution/Notice

# KCM Series High Dielectric Constant Type AEC-Q200 Anti-noise Deflecting crack Soldering crack Part Number List

## ■ 6.1×5.3mm

T max.	Rated Voltage	TC Code	Cap.	Tol.	Part Number
3.0mm	100Vdc	X7R	4.7μF	±10%	KCM55LR72A475KH01#
	63Vdc	X7R	4.7μF	±10%	KCM55LR71J475KH01#
	50Vdc	X7R	4.7μF	±10%	KCM55LR71H475KH01#
			10μF	±10%	KCM55LR71H106KH01#
	35Vdc	X7R	10μF	±10%	KCM55LR7YA106KH01#
			15μF	±10%	KCM55LR7YA156KH01#
25Vdc	X7R	15μF	±10%	KCM55LR71E156KH01#	
3.9mm	100Vdc	X7R	6.8μF	±10%	KCM55QR72A685KH01#
	63Vdc	X7R	10μF	±10%	KCM55QR71J106KH01#
	50Vdc	X7R	17μF	±10%	KCM55QR71H176KH01#
			35Vdc	X7R	17μF
	25Vdc	X7R	22μF	±10%	KCM55QR7YA226KH01#
			22μF	±10%	KCM55QR71E226KH01#
33μF			±10%	KCM55QR71E336KH01#	
5.0mm	100Vdc	X7R	10μF	±20%	KCM55TR72A106MH01#
	50Vdc	X7R	22μF	±20%	KCM55TR71H226MH01#
	35Vdc	X7R	22μF	±20%	KCM55TR7YA226MH01#
			33μF	±20%	KCM55TR7YA336MH01#
	25Vdc	X7R	33μF	±20%	KCM55TR71E336MH01#
6.7mm	100Vdc	X7R	15μF	±20%	KCM55WR72A156MH01#
	63Vdc	X7R	22μF	±20%	KCM55WR71J226MH01#
	50Vdc	X7R	33μF	±20%	KCM55WR71H336MH01#
	35Vdc	X7R	47μF	±20%	KCM55WR7YA476MH01#
	25Vdc	X7R	47μF	±20%	KCM55WR71E476MH01#
			68μF	±20%	KCM55WR71E686MH01#

GCM Series

GCD Series

GCE Series

GCG Series

GCJ Series

GC3 Series

KCM Series

KC3 Series

⚠Caution/Notice

## Metal Terminal Type/High Effective Capacitance & High Allowable Ripple Current

# KC3 Series



**AEC-Q200** **Anti-noise** **Deflecting crack** **Soldering crack**

By bonding metal terminals to the external electrodes of the chip, the problem of how to design a capacitor to enable it to be mounted on a large MLCC has been solved!

### Features

#### ① Bond the metal terminals to the external electrodes of the chip.

The stress on the chip is reduced due to the elastic behavior of the metal terminals.

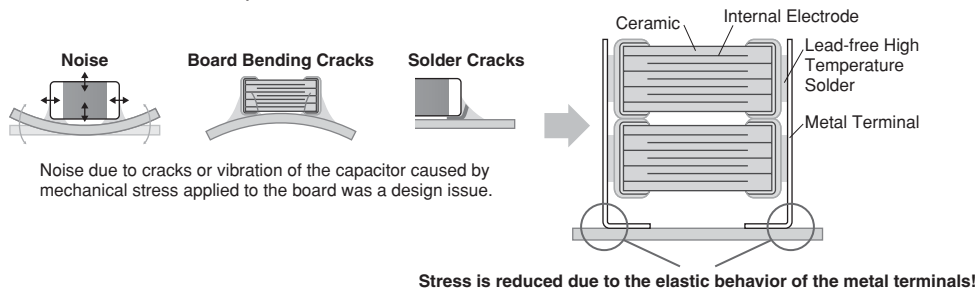

#### ② Noise, board deflection cracks, and solder cracks are greatly reduced.

No breakage occurs even when the board deflection is 6mm.  
 Solder cracks were not found even after 2000 heat stress cycles.

Comparison of Noise Reduction Effect

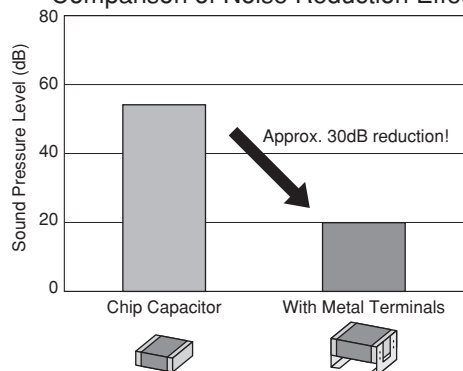

Evaluation Items: 2220 size/DC630V/220nF  
 Test Conditions: 50V, AC10Vp-p/3kHz  
 Sample Board: Glass-epoxy Board (T: 1.6mm)  
 Number of samples: 3  
 Distance between microphone and board: 3mm

Note: Results obtained using Murata's evaluation board

Stress caused by board deflection is reduced.

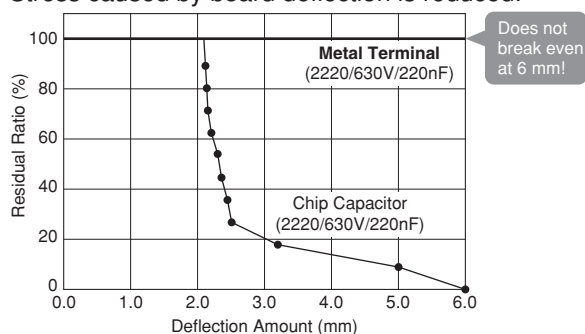

Solder cracks due to heat stress are reduced.

Chip Size	Individual Chip (2220 size)	Metal Terminal (2220 size)
1000 cycles	 ↑Solder cracks	
2000 cycles	 ↑Solder cracks	

Compared to an individual chip, the addition of metal terminals results in excellent solder cracking resistance.

Test Conditions: -55 to +125°C, 5 minutes (liquid phase)  
 Board used: Glass-epoxy Board (FR-4)

**3 Uses material of low dielectric constant.**

Compared to a conventional capacitor (X7R characteristics), this series has higher effective capacitance and better anti-ripple performance.

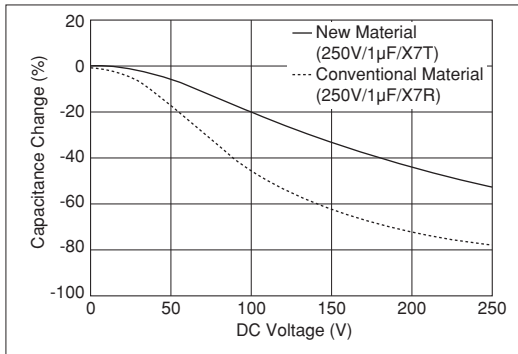

**4 Chip Stacking**

A large capacitance can be realized by stacking two capacitors on top of each other.

**Specifications**

Size	6.1×5.3mm
Rated Voltage	250Vdc to 630Vdc
Capacitance	0.1µF to 2.2µF
Main Applications	For drive control of engine ECU, etc. For other drive system control and safety equipment

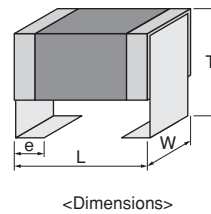

GCM Series

GCD Series

GCE Series

GCG Series

GCI Series

GCC Series

KCM Series

KC3 Series

⚠Caution/Notice



# KC3 Series High Dielectric Constant Type AEC-Q200 Anti-noise Deflecting crack Soldering crack Part Number List

## ■ 6.1×5.3mm

T max.	Rated Voltage	TC Code	Cap.	Tol.	Part Number
3.0mm	630Vdc	X7T	0.10μF	±10%	KC355LD72J104KH01#
			0.15μF	±10%	KC355LD72J154KH01#
	450Vdc	X7T	0.22μF	±10%	KC355LD72W224KH01#
			0.33μF	±10%	KC355LD72W334KH01#
			0.47μF	±10%	KC355LD72W474KH01#
	250Vdc	X7T	0.47μF	±10%	KC355LD72E474KH01#
0.68μF			±10%	KC355LD72E684KH01#	
3.9mm	630Vdc	X7T	0.22μF	±10%	KC355QD72J224KH01#
			0.27μF	±10%	KC355QD72J274KH01#
	450Vdc	X7T	0.56μF	±10%	KC355QD72W564KH01#
			1.0μF	±10%	KC355QD72E105KH01#
5.0mm	450Vdc	X7T	0.68μF	±20%	KC355TD72W684MH01#
			1.0μF	±20%	KC355TD72W105MH01#
	250Vdc	X7T	1.5μF	±20%	KC355TD72E155MH01#
6.7mm	630Vdc	X7T	0.47μF	±20%	KC355WD72J474MH01#
			0.56μF	±20%	KC355WD72J564MH01#
	450Vdc	X7T	1.2μF	±20%	KC355WD72W125MH01#
			250Vdc	X7T	2.2μF

GCM Series

GCD Series

GCE Series

GCG Series

GCJ Series

GC3 Series

KCM Series

KC3 Series

⚠Caution/Notice

## For Automotive

## ⚠Caution/Notice

### ⚠Caution

■ Storage and Operation Conditions .....	47
■ Rating .....	47
1. Temperature Dependent Characteristics .....	47
2. Measurement of Capacitance .....	47
3. Applied Voltage .....	48
4. Type of Applied Voltage and Self-heating Temperature .....	48
5. DC Voltage and AC Voltage Characteristics .....	50
6. Capacitance Aging .....	50
7. Vibration and Shock .....	51
■ Soldering and Mounting .....	51
1. Mounting Position .....	51
2. Information before Mounting .....	52
3. Maintenance of the Mounting (pick and place) Machine .....	52
4-1. Reflow Soldering .....	53
4-2. Flow Soldering .....	54
4-3. Correction of Soldered Portion .....	55
5. Washing .....	56
6. Electrical Test on Printed Circuit Board .....	56
7. Printed Circuit Board Cropping .....	56
8. Assembly .....	59
9. Selection of Conductive Adhesive, Mounting Process, and Bonding Strength .....	60
10. Moisture Proof Process .....	60
11. Application .....	60
■ Other .....	60
1. Under Operation of Equipment .....	60
2. Other .....	60

### Notice

■ Rating .....	61
1. Operating Temperature .....	61
2. Atmosphere Surroundings .....	61
3. Piezo-electric Phenomenon .....	61
■ Soldering and Mounting .....	61
1. PCB Design .....	61
1. Notice for Pattern Forms .....	61
2. Land Dimensions .....	62
3. Board Design .....	63
2. Adhesive Application .....	63
3. Adhesive Curing .....	63
4. Flux for Reflow and Flow Soldering .....	64
5. Flow Soldering .....	64
6. Washing .....	64
7. Coating .....	64
■ Other .....	65
1. Transportation .....	65
2. Characteristics Evaluation in the Actual System .....	65

GCM Series

GCD Series

GCE Series

GCG Series

GCI Series

GCI Series

KCM Series

KC3 Series

⚠Caution/Notice

## ■ Storage and Operation Conditions

1. The performance of chip monolithic ceramic capacitors may be affected by the storage conditions.

1-1. Store the capacitors in the following conditions:

Room Temperature of +5°C to +40°C and a Relative Humidity of 20% to 70%.

(1) Sunlight, dust, rapid temperature changes, corrosive gas atmosphere, or high temperature and humidity conditions during storage may affect solderability and packaging performance.

Therefore, please maintain the storage temperature and humidity. Use the product within six months, as prolonged storage may cause oxidation of the electrodes.

(2) Please confirm solderability before using after six months. Store the capacitors without opening the original bag. Even if the storage period is short, do not exceed the specified atmospheric conditions.

1-2. Corrosive gas can react with the termination (external) electrodes or lead wires of capacitors, and result in poor solderability. Do not store the capacitors in an atmosphere consisting of corrosive gas (e.g., hydrogen sulfide, sulfur dioxide, chlorine, ammonia gas, etc.).

1-3. Due to moisture condensation caused by rapid humidity changes, or the photochemical change caused by direct sunlight on the terminal electrodes and/or the resin/epoxy coatings, the solderability and electrical performance may deteriorate. Do not store capacitors under direct sunlight or in high humidity conditions.

<Applicable to GCG Series>

1-4. After unpacking, immediately reseal, or store in a desiccator containing a desiccant.

## ■ Rating

### 1. Temperature Dependent Characteristics

1. The electrical characteristics of a capacitor can change with temperature.

1-1. For capacitors having larger temperature dependency, the capacitance may change with temperature changes.

The following actions are recommended in order to ensure suitable capacitance values.

(1) Select a suitable capacitance for the operating temperature range.

(2) The capacitance may change within the rated temperature.

When you use a high dielectric constant type capacitor in a circuit that needs a tight (narrow) capacitance tolerance (e.g., a time-constant circuit), please carefully consider the temperature characteristics, and carefully confirm the various characteristics in actual use conditions and the actual system.

### 2. Measurement of Capacitance

1. Measure capacitance with the voltage and frequency specified in the product specifications.

1-1. The output voltage of the measuring equipment may decrease occasionally when capacitance is high. Please confirm whether a prescribed measured voltage is impressed to the capacitor.

1-2. The capacitance values of high dielectric constant type capacitors change depending on the AC voltage applied. Please consider the AC voltage characteristics when selecting a capacitor to be used in an AC circuit.

[Typical Temperature Characteristics X7R(R7)]

Sample: 0.1μF, Rated Voltage 50VDC

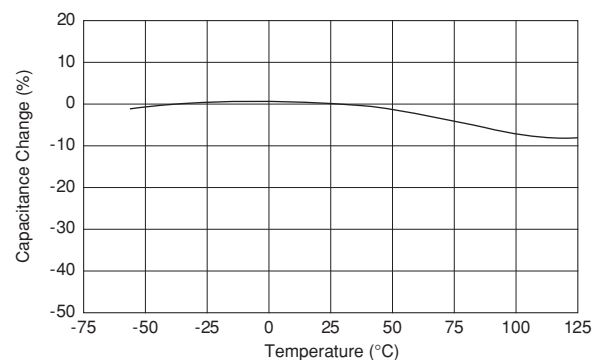

**⚠Caution**

☐ Continued from the preceding page.

**3. Applied Voltage**

1. Do not apply a voltage to the capacitor that exceeds the rated voltage as called out in the specifications.

1-1. Applied voltage between the terminals of a capacitor shall be less than or equal to the rated voltage.

(1) When AC voltage is superimposed on DC voltage, the zero-to-peak voltage shall not exceed the rated DC voltage.

When AC voltage or pulse voltage is applied, the peak-to-peak voltage shall not exceed the rated DC voltage.

(2) Abnormal voltages (surge voltage, static electricity, pulse voltage, etc.) shall not exceed the rated DC voltage.

Typical Voltage Applied to the DC Capacitor

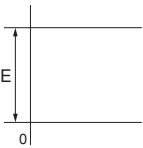
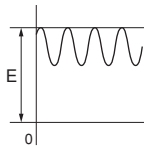
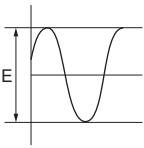
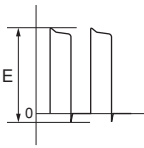
DC Voltage	DC Voltage+AC	AC Voltage	Pulse Voltage
			

(E: Maximum possible applied voltage.)

1-2. Influence of over voltage

Over voltage that is applied to the capacitor may result in an electrical short circuit caused by the breakdown of the internal dielectric layers.

The time duration until breakdown depends on the applied voltage and the ambient temperature.

2. Use a safety standard certified capacitor in a power supply input circuit (AC filter), as it is also necessary to consider the withstand voltage and impulse withstand voltage defined for each device.

**4. Type of Applied Voltage and Self-heating Temperature**

1. Confirm the operating conditions to make sure that no large current is flowing into the capacitor due to the continuous application of an AC voltage or pulse voltage.

When a DC rated voltage product is used in an AC voltage circuit or a pulse voltage circuit, the AC current or pulse current will flow into the capacitor; therefore check the self-heating condition.

Please confirm the surface temperature of the capacitor so that the temperature remains within the upper limits of the operating temperature, including the rise in temperature due to self-heating. When the capacitor is used with a high-frequency voltage or pulse voltage, heat may be generated by dielectric loss.

<Applicable to Rated Voltage of less than 100VDC>

1-1. The load should be contained to the level such that when measuring at atmospheric temperature of 25°C, the product's self-heating remains below 20°C and the surface temperature of the capacitor in the actual circuit remains within the maximum operating temperature.

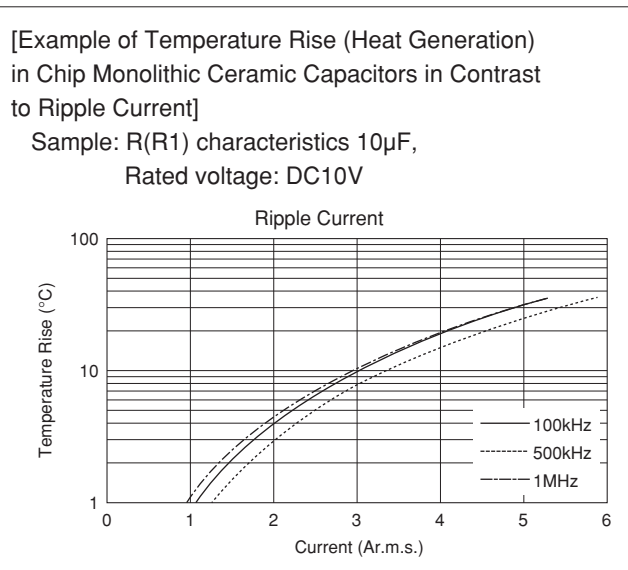

Continued on the following page. ↗

GCM Series

GCD Series

GCE Series

GCG Series

GCI Series

GCC Series

KCM Series

KC3 Series

⚠Caution

↳ Continued from the preceding page.

<Applicable to Temperature Characteristics X7R(R7), X7T(D7) beyond Rated Voltage of 250VDC>

1-2. The load should be contained so that the self-heating of the capacitor body remains below 20°C, when measuring at an ambient temperature of 25°C. In addition, use a K thermocouple of ø0.1mm with less heat capacity when measuring, and measure in a condition where there is no effect from the radiant heat of other components or air flow caused by convection. Excessive generation of heat may cause deterioration of the characteristics and reliability of the capacitor. (Absolutely do not perform measurements while the cooling fan is operating, as an accurate measurement may not be performed.)

<Applicable to Temperature Characteristics U2J(7U) beyond Rated Voltage of 250VDC>

1-3. Since the self-heating is low in the low loss series, the allowable power becomes extremely high compared to the common X7R(R7) characteristics. However, when a load with self-heating of 20°C is applied at the rated voltage, the allowable power may be exceeded. When the capacitor is used in a high-frequency voltage circuit of 1kHz or more, the frequency of the applied voltage should be less than 500kHz sine wave (less than 100kHz for a product with rated voltage of DC3.15kV), to limit the voltage load so that the load remains within the derating shown in the following figure. In the case of non-sine wave, high-frequency components exceeding the fundamental frequency may be included. In such a case, please contact Murata. The excessive generation of heat may cause deterioration of the characteristics and reliability of the capacitor. (Absolutely do not perform measurements while the cooling fan is operating, as an accurate measurement may not be performed.)

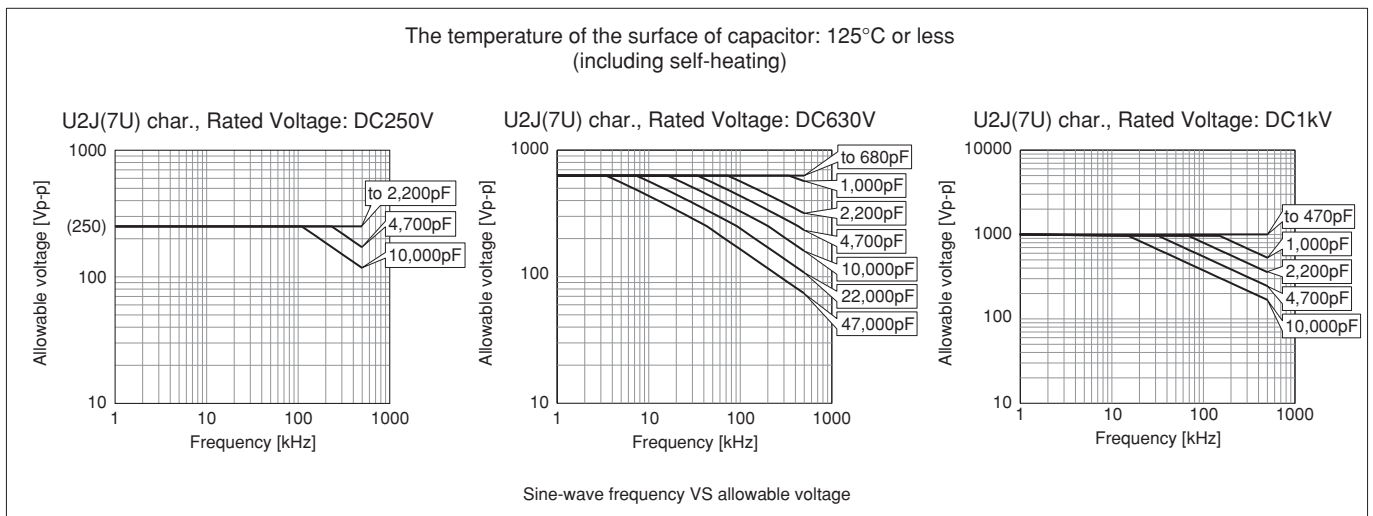

<Design Tool>

• Simsurfing

Simsurfing is a web application to display the characteristics charts and download the characteristics data of our products. The frequency characteristics, temperature characteristics, bias characteristics etc. can be checked.

(Address: <http://www.murata.com/simsurfing/>)

• Medium Voltage Ceramic Capacitor Selection Tool

The selection tool "Murata Medium Voltage Capacitors Selection Tool by Voltage Form" is installed in the above SimSurfing, where the usability of the preferred medium voltage ceramic capacitors can be determined according to the application including automobiles.

By using this tool, the preferred products\* can be checked by specifications, such as the power, voltage, and fundamental frequency of the voltage waveform to be input into the capacitor.

\*Supported Series

Temperature characteristics U2J(7U) of GCM/DC250V or more

Continued on the following page. ↗

**⚠Caution**

☐ Continued from the preceding page.

**5. DC Voltage and AC Voltage Characteristics**

1. The capacitance value of a high dielectric constant type capacitor changes depending on the DC voltage applied. Please consider the DC voltage characteristics when a capacitor is selected for use in a DC circuit.

1-1. The capacitance of ceramic capacitors may change sharply depending on the applied voltage (see figure).

Please confirm the following in order to secure the capacitance.

- (1) Determine whether the capacitance change caused by the applied voltage is within the allowed range.
- (2) In the DC voltage characteristics, the rate of capacitance change becomes larger as voltage increases, even if the applied voltage is below the rated voltage. When a high dielectric constant type capacitor is used in a circuit that requires a tight (narrow) capacitance tolerance (e.g., a time constant circuit), please carefully consider the voltage characteristics, and confirm the various characteristics in actual operating conditions in an actual system.

2. The capacitance values of high dielectric constant type capacitors changes depending on the AC voltage applied. Please consider the AC voltage characteristics when selecting a capacitor to be used in an AC circuit.

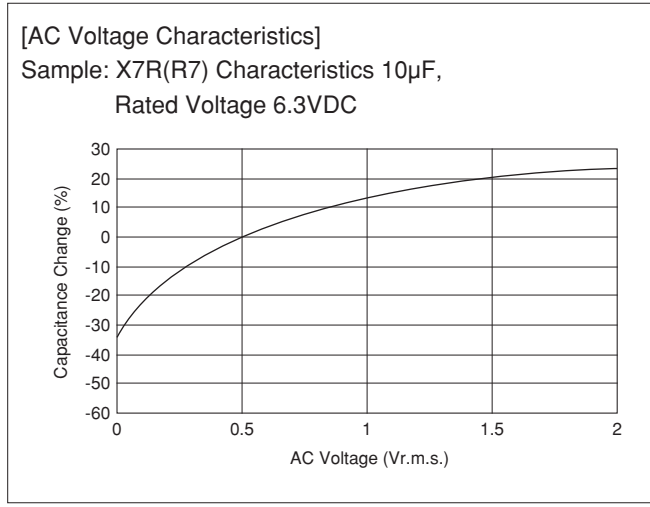
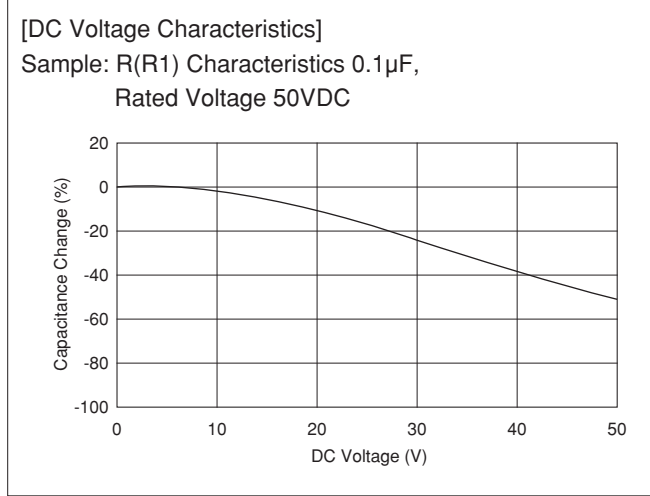

**6. Capacitance Aging**

1. The high dielectric constant type capacitors have the Characteristics in which the capacitance value decreases with the passage of time.

When you use high dielectric constant type capacitors in a circuit that needs a tight (narrow) capacitance tolerance (e.g., a time-constant circuit), please carefully consider the characteristics of these capacitors, such as their aging, voltage, and temperature characteristics. In addition, check capacitors using your actual appliances at the intended environment and operating conditions.

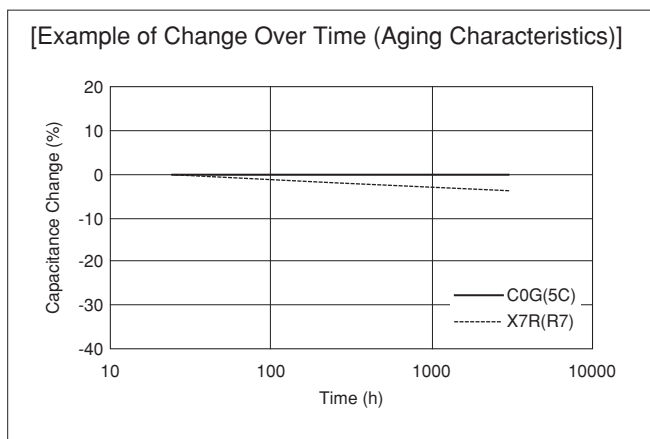

Continued on the following page. ↗

GCM Series  
 GCD Series  
 GCE Series  
 GCG Series  
 GCJ Series  
 GC3 Series  
 KCM Series  
 KC3 Series  
 ⚠Caution

↳ Continued from the preceding page.

## 7. Vibration and Shock

1. Please confirm the kind of vibration and/or shock, its condition, and any generation of resonance.  
Please mount the capacitor so as not to generate resonance, and do not allow any impact on the terminals.
2. Mechanical shock due to being dropped may cause damage or a crack in the dielectric material of the capacitor.  
Do not use a dropped capacitor because the quality and reliability may be deteriorated.
3. When printed circuit boards are piled up or handled, the corner of another printed circuit board should not be allowed to hit the capacitor, in order to avoid a crack or other damage to the capacitor.

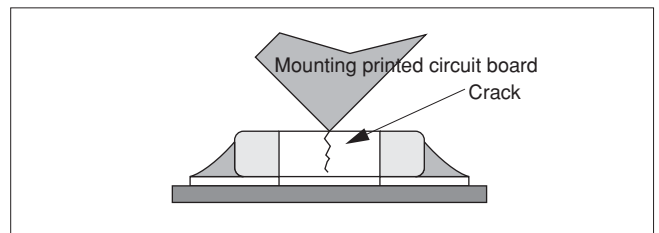
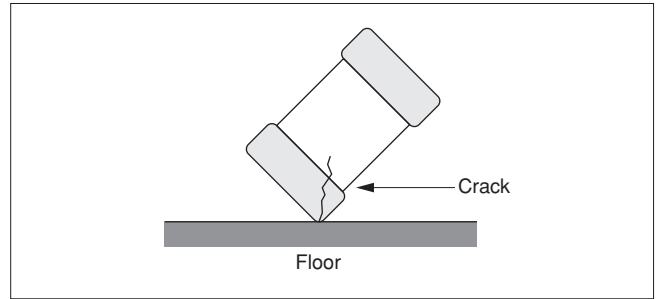

## ■ Soldering and Mounting

### 1. Mounting Position

1. Confirm the best mounting position and direction that minimizes the stress imposed on the capacitor during flexing or bending the printed circuit board.
  - 1-1. Choose a mounting position that minimizes the stress imposed on the chip during flexing or bending of the board.

#### [Component Direction]

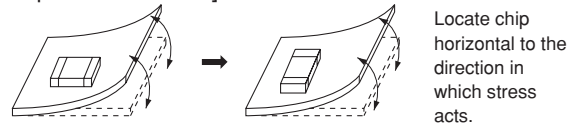

#### [Chip Mounting Close to Board Separation Point]

It is effective to implement the following measures, to reduce stress in separating the board.  
It is best to implement all of the following three measures; however, implement as many measures as possible to reduce stress.

Contents of Measures	Stress Level
(1) Turn the mounting direction of the component parallel to the board separation surface.	A > D
(2) Add slits in the board separation part.	A > B
(3) Keep the mounting position of the component away from the board separation surface.	A > C

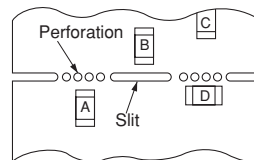

#### [Mounting Capacitors Near Screw Holes]

When a capacitor is mounted near a screw hole, it may be affected by the board deflection that occurs during the tightening of the screw. Mount the capacitor in a position as far away from the screw holes as possible.

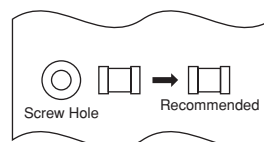

## ⚠Caution

☐ Continued from the preceding page.

### 2. Information before Mounting

1. Do not re-use capacitors that were removed from the equipment.
2. Confirm capacitance characteristics under actual applied voltage.
3. Confirm the mechanical stress under actual process and equipment use.
4. Confirm the rated capacitance, rated voltage and other electrical characteristics before assembly.
5. Prior to use, confirm the solderability of capacitors that were in long-term storage.
6. Prior to measuring capacitance, carry out a heat treatment for capacitors that were in long-term storage.
7. The use of Sn-Zn based solder will deteriorate the reliability of the MLCC.

Please contact our sales representative or product engineers on the use of Sn-Zn based solder in advance.

8. We have also produced a DVD which shows a summary of our opinions, regarding the precautions for mounting. Please contact our sales representative to request the DVD.

### 3. Maintenance of the Mounting (pick and place) Machine

1. Make sure that the following excessive forces are not applied to the capacitors.

1-1. In mounting the capacitors on the printed circuit board, any bending force against them shall be kept to a minimum to prevent them from any bending damage or cracking. Please take into account the following precautions and recommendations for use in your process.

- (1) Adjust the lowest position of the pickup nozzle so as not to bend the printed circuit board.
- (2) Adjust the nozzle pressure within a static load of 1N to 3N during mounting.

2. Dirt particles and dust accumulated between the suction nozzle and the cylinder inner wall prevent the nozzle from moving smoothly. This imposes greater force upon the chip during mounting, causing cracked chips. Also, the locating claw, when worn out, imposes uneven forces on the chip when positioning, causing cracked chips. The suction nozzle and the locating claw must be maintained, checked, and replaced periodically.

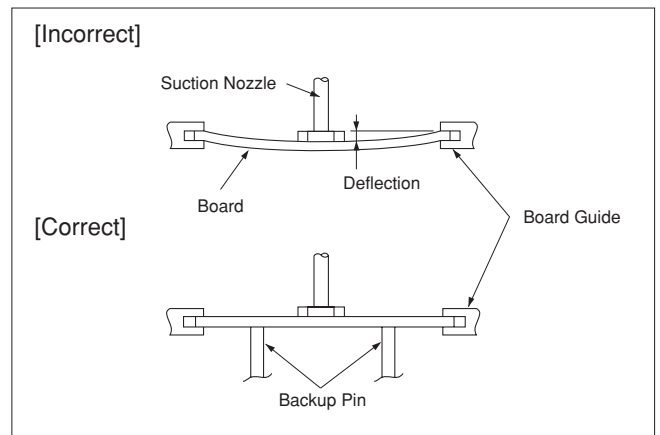

Continued on the following page. ☐



☐ Continued from the preceding page.

### 4-1. Reflow Soldering

- When sudden heat is applied to the components, the mechanical strength of the components will decrease because a sudden temperature change causes deformation inside the components. In order to prevent mechanical damage to the components, preheating is required for both the components and the PCB. Preheating conditions are shown in table 1. It is required to keep the temperature differential between the solder and the components surface ( $\Delta T$ ) as small as possible.
- Solderability of tin plating termination chips might be deteriorated when a low temperature soldering profile where the peak solder temperature is below the melting point of tin is used. Please confirm the solderability of tin plated termination chips before use.
- When components are immersed in solvent after mounting, be sure to maintain the temperature difference ( $\Delta T$ ) between the component and the solvent within the range shown in table 1.

Table 1

Part Number	Temperature Differential
<b>GC3/GCD/GCE/GCJ/GCM Series</b> 03/15/18/21/31 sizes	$\Delta T \leq 190^\circ\text{C}$
<b>GCJ/GCM Series</b> 32/43/55 sizes <b>KC3/KCM Series</b> 55 size	$\Delta T \leq 130^\circ\text{C}$

#### Recommended Conditions

	Pb-Sn Solder		Lead Free Solder
	Reflow	Vapor Reflow	
Peak Temperature	230 to 250°C	230 to 240°C	240 to 260°C
Atmosphere	Air	Saturated vapor of inactive solvent	Air or N <sub>2</sub>

Pb-Sn Solder: Sn-37Pb

Lead Free Solder: Sn-3.0Ag-0.5Cu

#### 4. Optimum Solder Amount for Reflow Soldering

- Overly thick application of solder paste results in a excessive solder fillet height. This makes the chip more susceptible to mechanical and thermal stress on the board and may cause the chips to crack.
- Too little solder paste results in a lack of adhesive strength on the outer electrode, which may result in chips breaking loose from the PCB.
- Make sure the solder has been applied smoothly to the end surface to a height of 0.2mm\* min.

#### Inverting the PCB

Make sure not to impose any abnormal mechanical shocks to the PCB.

#### [Standard Conditions for Reflow Soldering]

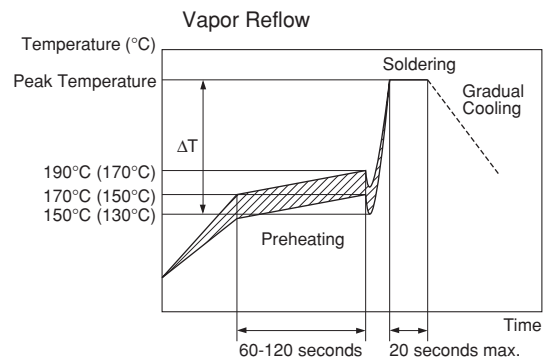
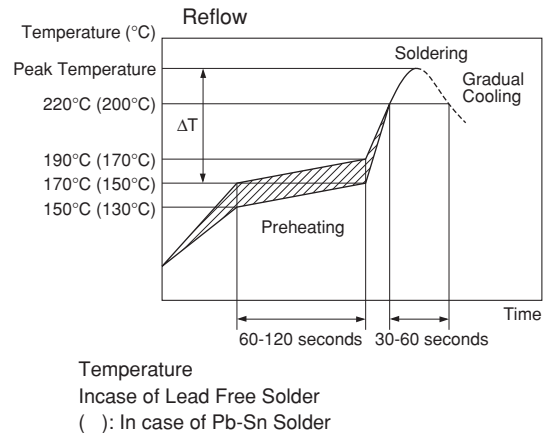

#### [Allowable Reflow Soldering Temperature and Time]

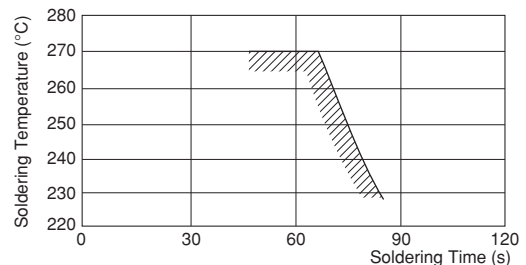

In the case of repeated soldering, the accumulated soldering time must be within the range shown above.

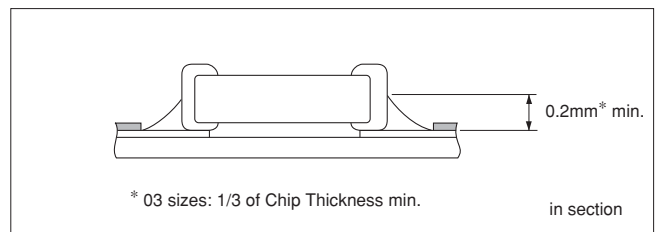

**⚠Caution**

☐ Continued from the preceding page.

**4-2. Flow Soldering**

1. Do not apply flow soldering to chips not listed in table 2.

**Table 2**

Part Number	Temperature Differential
<b>GC3/GCD/GCM Series 18/21/31 sizes</b> (Except for characteristics of X8L(L8), X8G(5G))	$\Delta T \leq 150^{\circ}\text{C}$
<b>GCJ Series Rated Voltage 250VDC</b> or more <b>18/21/31 sizes</b>	

- When sudden heat is applied to the components, the mechanical strength of the components will decrease because a sudden temperature change causes deformation inside the components. In order to prevent mechanical damage to the components, preheating is required for both of the components and the PCB. Preheating conditions are shown in table 2. It is required to keep the temperature differential between the solder and the components surface ( $\Delta T$ ) as low as possible.
- Excessively long soldering time or high soldering temperature can result in leaching of the outer electrodes, causing poor adhesion or a reduction in capacitance value due to loss of contact between the electrodes and end termination.
- When components are immersed in solvent after mounting, be sure to maintain the temperature differential ( $\Delta T$ ) between the component and solvent within the range shown in the table 2.

**Recommended Conditions**

	Pb-Sn Solder	Lead Free Solder
Preheating Peak Temperature	90 to 110°C	100 to 120°C
Soldering Peak Temperature	240 to 250°C	250 to 260°C
Atmosphere	Air	Air

Pb-Sn Solder: Sn-37Pb  
 Lead Free Solder: Sn-3.0Ag-0.5Cu

**5. Optimum Solder Amount for Flow Soldering**

5-1. The top of the solder fillet should be lower than the thickness of the components. If the solder amount is excessive, the risk of cracking is higher during board bending or any other stressful condition.

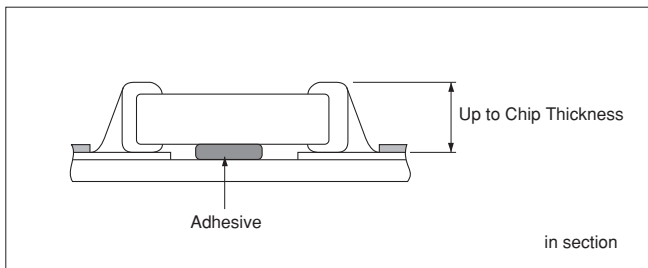
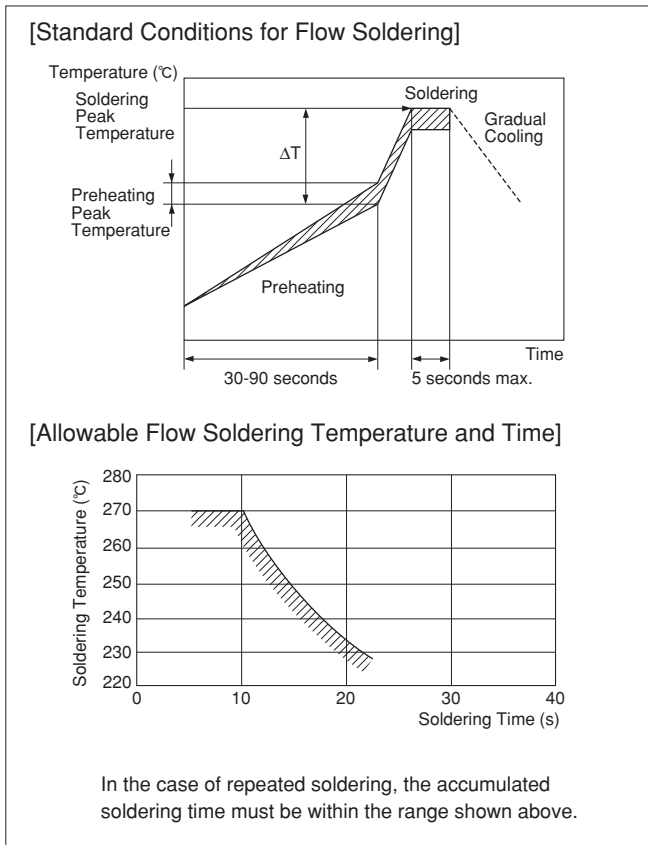

Continued on the following page. ☐

GCM Series

GCD Series

GCE Series

GCG Series

GCJ Series

GC3 Series

KCM Series

KC3 Series

⚠Caution

☐ Continued from the preceding page.

### 4-3. Correction of Soldered Portion

When sudden heat is applied to the capacitor, distortion caused by the large temperature difference occurs internally, and can be the cause of cracks. Capacitors also tend to be affected by mechanical and thermal stress depending on the board preheating temperature or the soldering fillet shape, and can be the cause of cracks. Please refer to "1. PCB Design" or "3. Optimum solder amount" for the solder amount and the fillet shapes.

#### 1. Correction with a Soldering Iron

- 1-1. In order to reduce damage to the capacitor, be sure to preheat the capacitor and the mounting board. Preheat to the temperature range shown in Table 3. A hot plate, hot air type preheater, etc. can be used for preheating.
- 1-2. After soldering, do not allow the component/PCB to cool down rapidly.
- 1-3. Perform the corrections with a soldering iron as quickly as possible. If the soldering iron is applied too long, there is a possibility of causing solder leaching on the terminal electrodes, which will cause deterioration of the adhesive strength and other problems.

#### 2. Correction with Spot Heater

Compared to local heating with a soldering iron, hot air heating by a spot heater heats the overall component and board, therefore, it tends to lessen the thermal shock. In the case of a high density mounted board, a spot heater can also prevent concerns of the soldering iron making direct contact with the component.

- 2-1. If the distance from the hot air outlet of the spot heater to the component is too close, cracks may occur due to thermal shock. To prevent this problem, follow the conditions shown in Table 4.

- 2-2. In order to create an appropriate solder fillet shape, it is recommended that hot air be applied at the angle shown in Figure 1.

#### 3. Optimum solder amount when re-working with a soldering iron

- 3-1. In the case of sizes smaller than 0603, (GC3/GCD/GCE/GCJ/GCM Series, 03/15/18 sizes), the top of the solder fillet should be lower than  $\frac{2}{3}$  of the thickness of the component or 0.5mm, whichever is smaller. In the case of 0805 and larger sizes, (GC3/GCD/GCE/GCJ/GCM Series, 21/31/32/43/55 sizes), the top of the solder fillet should be lower than  $\frac{2}{3}$  of the thickness of the component. If the solder amount is excessive, the risk of cracking is higher during board bending or under any other stressful condition.

Table 3

Part Number	Temperature of Soldering Iron Tip	Preheating Temperature	Temperature Differential ( $\Delta T$ )	Atmosphere
GC3/GCD/GCE/ GCJ/GCM Series 03/15/18/21/31 sizes	350°C max.	150°C min.	$\Delta T \leq 190^\circ\text{C}$	Air
GCJ/GCM Series 32/43/55 sizes	280°C max.	150°C min.	$\Delta T \leq 130^\circ\text{C}$	Air

\*Applicable for both Pb-Sn and Lead Free Solder.  
 Pb-Sn Solder: Sn-37Pb  
 Lead Free Solder: Sn-3.0Ag-0.5Cu

Table 4

Distance	5mm or more
Hot Air Application Angle	45° *Figure 1
Hot Air Temperature Nozzle Outlet	400°C max.
Application Time	Less than 10 seconds (1206 (3216 in mm) size or smaller)
	Less than 30 seconds (1210 (3225 in mm) size or larger)

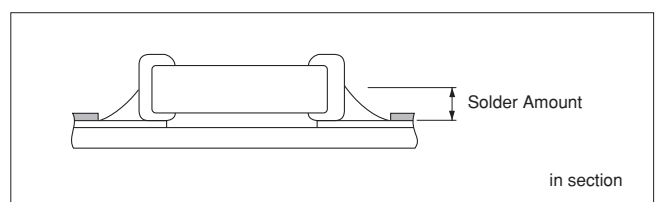
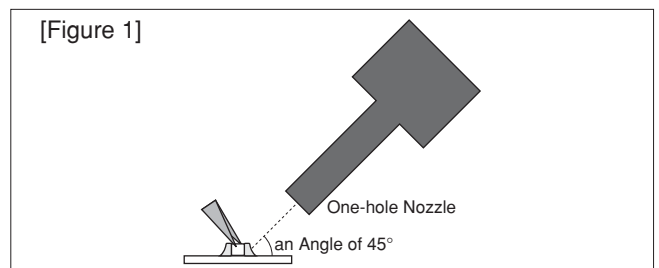

**⚠Caution**

☐ Continued from the preceding page.

- 3-2. A soldering iron with a tip of  $\phi 3\text{mm}$  or smaller should be used. It is also necessary to keep the soldering iron from touching the components during the re-work.
- 3-3. Solder wire with  $\phi 0.5\text{mm}$  or smaller is required for soldering.

<Applicable to KC3/KCM Series>

4. For the shape of the soldering iron tip, refer to the figure on the right.

Regarding the type of solder, use a wire diameter of  $\phi 0.5\text{mm}$  or less (rosin core wire solder).

4-1. How to Apply the Soldering Iron

Apply the tip of the soldering iron against the lower end of the metal terminal.

- 1) In order to prevent cracking caused by sudden heating of the ceramic device, do not touch the ceramic base directly.
- 2) In order to prevent deviations and dislocating of the chip, do not touch the junction of the chip and the metal terminal, and the metal portion on the outside directly.

4-2. Appropriate Amount of Solder

The amount of solder for corrections by soldering iron, should be lower than the height of the lower side of the chip.

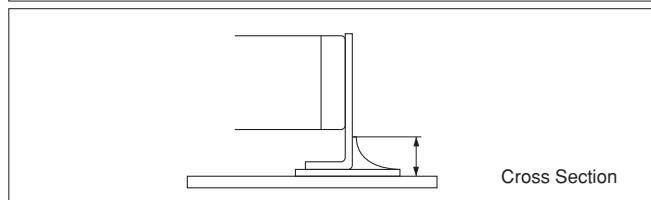
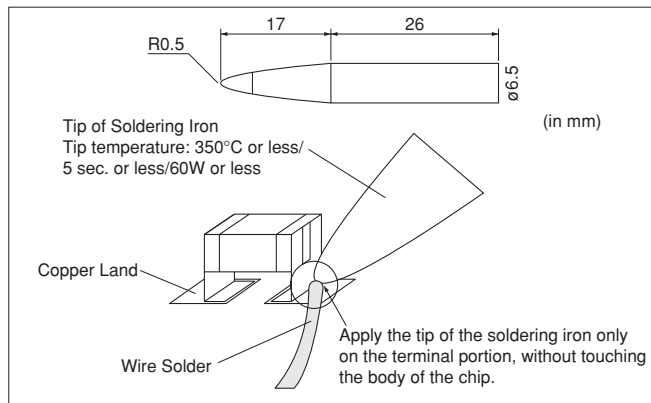

5. Washing

Excessive ultrasonic oscillation during cleaning can cause the PCBs to resonate, resulting in cracked chips or broken solder joints. Take note not to vibrate PCBs.

6. Electrical Test on Printed Circuit Board

1. Confirm position of the backup pin or specific jig, when inspecting the electrical performance of a capacitor after mounting on the printed circuit board.

1-1. Avoid bending the printed circuit board by the pressure of a test-probe, etc.

The thrusting force of the test probe can flex the PCB, resulting in cracked chips or open solder joints.

Provide backup pins on the back side of the PCB to prevent warping or flexing. Install backup pins as close to the test-probe as possible.

1-2. Avoid vibration of the board by shock when a test-probe contacts a printed circuit board.

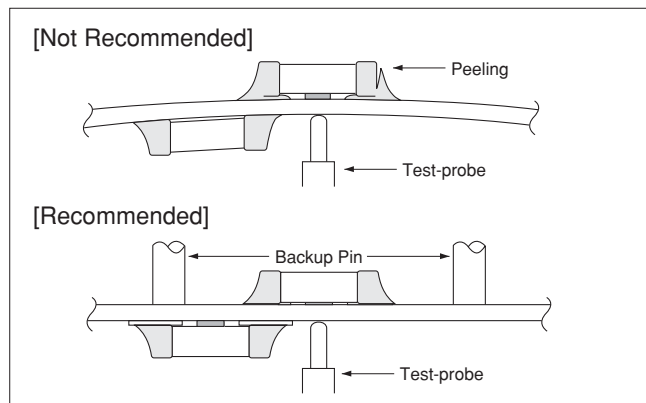

7. Printed Circuit Board Cropping

1. After mounting a capacitor on a printed circuit board, do not apply any stress to the capacitor that causes bending or twisting the board.

1-1. In cropping the board, the stress as shown at right may cause the capacitor to crack.

Avoid this type of stress to a capacitor.

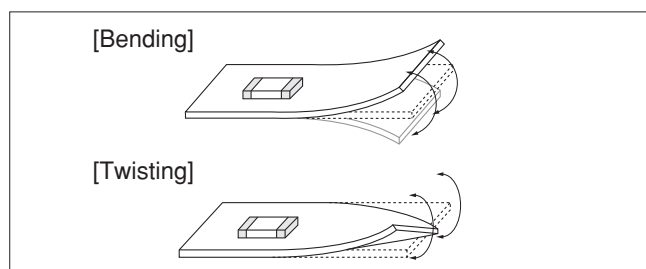

Continued on the following page. ↗

GCM Series

GCD Series

GCE Series

GCG Series

GCH Series

GCH Series

KCM Series

KC3 Series

⚠Caution

☐ Continued from the preceding page.

2. Check the cropping method for the printed circuit board in advance.

2-1. Printed circuit board cropping shall be carried out by using a jig or an apparatus (Disk separator, router type separator, etc.) to prevent the mechanical stress that can occur to the board.

Board Separation Method	Hand Separation Nipper Separation	(1) Board Separation Jig	Board Separation Apparatus	
			(2) Disk Separator	(3) Router Type Separator
Level of stress on board	High	Medium	Medium	Low
Recommended	×	△*	△*	○
Notes	Hand and nipper separation apply a high level of stress. Use another method.	<ul style="list-style-type: none"> <li>Board handling</li> <li>Board bending direction</li> <li>Layout of capacitors</li> </ul>	<ul style="list-style-type: none"> <li>Board handling</li> <li>Layout of slits</li> <li>Design of V groove</li> <li>Arrangement of blades</li> <li>Controlling blade life</li> </ul>	Board handling

\* When a board separation jig or disk separator is used, if the following precautions are not observed, a large board deflection stress will occur and the capacitors may crack. Use router type separator if at all possible.

(1) Example of a suitable jig

[In the case of Single-side Mounting]

An outline of the board separation jig is shown as follows. Recommended example: Stress on the component mounting position can be minimized by holding the portion close to the jig, and bend in the direction towards the side where the capacitors are mounted. Not recommended example: The risk of cracks occurring in the capacitors increases due to large stress being applied to the component mounting position, if the portion away from the jig is held and bent in the direction opposite the side where the capacitors are mounted.

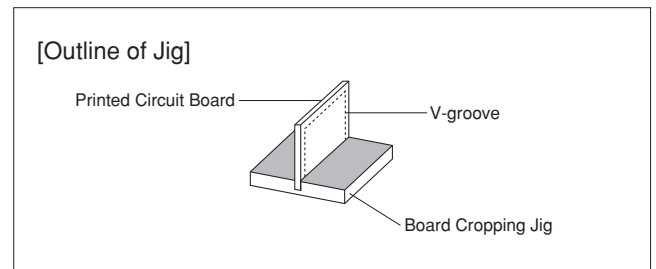

Recommended	Not Recommended

[In the case of Double-sided Mounting]

Since components are mounted on both sides of the board, the risk of cracks occurring can not be avoided with the above method.

Therefore, implement the following measures to prevent stress from being applied to the components. (Measures)

- (1) Consider introducing a router type separator.  
If it is difficult to introduce a router type separator, implement the following measures. (Refer to item 1. Mounting Position)
- (2) Mount the components parallel to the board separation surface.
- (3) When mounting components near the board separation point, add slits in the separation position near the component.
- (4) Keep the mounting position of the components away from the board separation point.

**⚠Caution**

☐ Continued from the preceding page.

**(2) Example of a Disk Separator**

An outline of a disk separator is shown as follows. As shown in the Principle of Operation, the top blade and bottom blade are aligned with the V-grooves on the printed circuit board to separate the board.

In the following case, board deflection stress will be applied and cause cracks in the capacitors.

- (1) When the adjustment of the top and bottom blades are misaligned, such as deviating in the top-bottom, left-right or front-rear directions
- (2) The angle of the V groove is too low, depth of the V groove is too shallow, or the V groove is misaligned top-bottom

IF V groove is too deep, it is possible to brake when you handle and carry it. Carefully design depth of the V groove with consideration about strength of material of the printed circuit board.

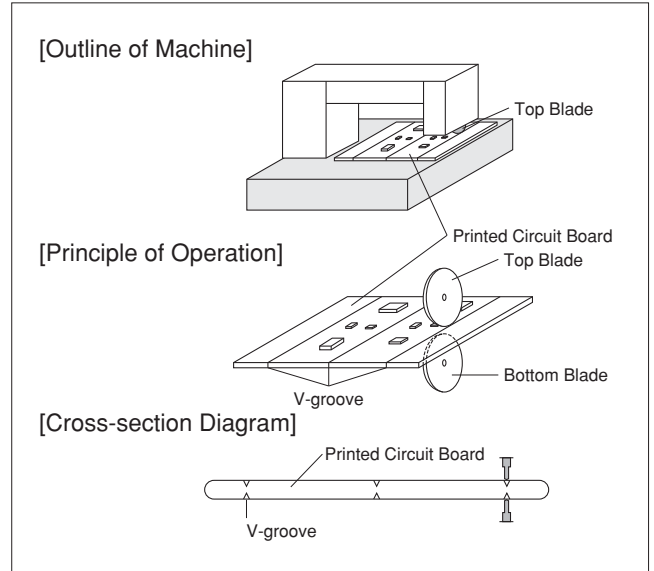

Recommended	Not Recommended		
	Top-bottom Misalignment	Left-right Misalignment	Front-rear Misalignment
<p>Top Blade</p> <p>Bottom Blade</p>	<p>Top Blade</p> <p>Bottom Blade</p>	<p>Top Blade</p> <p>Bottom Blade</p>	<p>Top Blade</p> <p>Bottom Blade</p>

Example of Recommended V-groove Design	Not Recommended			
	Left-right Misalignment	Low-Angle	Depth too Shallow	Depth too Deep

**(3) Example of Router Type Separator**

The router type separator performs cutting by a router rotating at a high speed. Since the board does not bend in the cutting process, stress on the board can be suppressed during board separation.

When attaching or removing boards to/from the router type separator, carefully handle the boards to prevent bending.

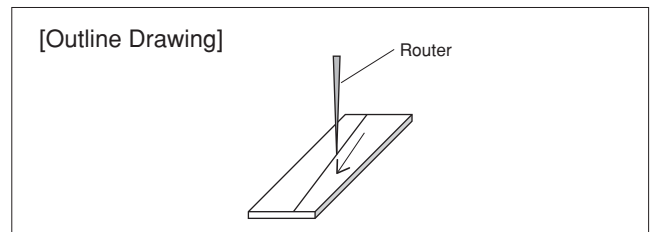

Continued on the following page. ☐

GCM Series

GCD Series

GCE Series

GCG Series

GCI Series

GCS Series

KCM Series

KC3 Series

⚠Caution

☐ Continued from the preceding page.

## 8. Assembly

### 1. Handling

If a board mounted with capacitors is held with one hand, the board may bend. Firmly hold the edges of the board with both hands when handling.

If a board mounted with capacitors is dropped, cracks may occur in the capacitors.

Do not use dropped boards, as there is a possibility that the quality of the capacitors may be impaired.

### 2. Attachment of Other Components

#### 2-1. Mounting of Other Components

Pay attention to the following items, when mounting other components on the back side of the board after capacitors have been mounted on the opposite side. When the bottom dead point of the suction nozzle is set too low, board deflection stress may be applied to the capacitors on the back side (bottom side), and cracks may occur in the capacitors.

- After the board is straightened, set the bottom dead point of the nozzle on the upper surface of the board.
- Periodically check and adjust the bottom dead point.

#### 2-2. Inserting Components with Leads into Boards

When inserting components (transformers, IC, etc.) into boards, bending the board may cause cracks in the capacitors or cracks in the solder.

Pay attention to the following.

- Increase the size of the holes to insert the leads, to reduce the stress on the board during insertion.
- Fix the board with backup pins or a dedicated jig before insertion.
- Support below the board so that the board does not bend. When using multiple backup pins on the board, periodically confirm that there is no difference in the height of each backup pin.

#### 2-3. Attaching/Removing Sockets

When the board itself is a connector, the board may bend when a socket is attached or removed. Plan the work so that the board does not bend when a socket is attached or removed.

#### 2-4. Tightening Screws

The board may be bent, when tightening screws, etc. during the attachment of the board to a shield or chassis.

Pay attention to the following items before performing the work.

- Plan the work to prevent the board from bending.
- Use a torque screwdriver, to prevent over-tightening of the screws.
- The board may bend after mounting by reflow soldering, etc. Please note, as stress may be applied to the chips by forcibly flattening the board when tightening the screws.

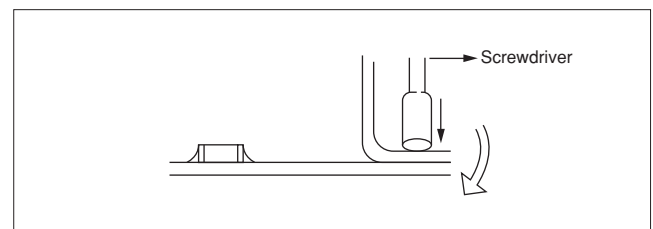
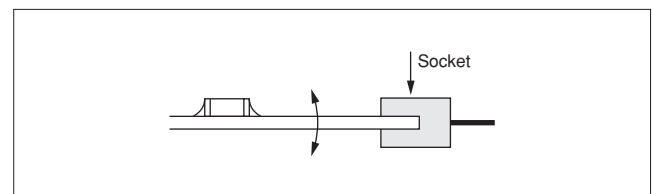
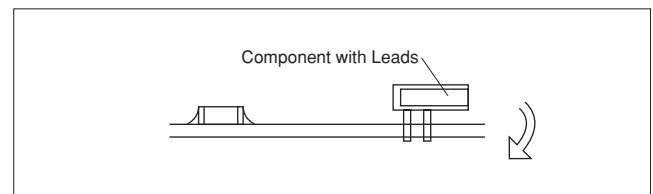
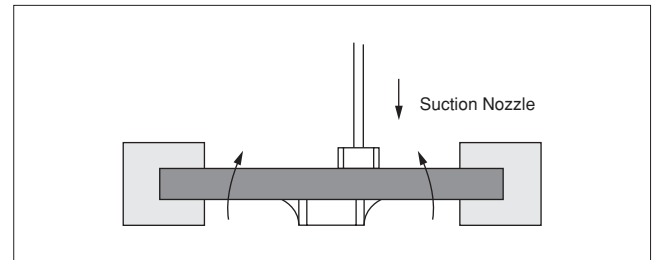

GCM Series

GCD Series

GCE Series

GCG Series

GCJ Series

GC3 Series

KCM Series

KC3 Series

⚠Caution

Continued on the following page. ☐

## ⚠Caution

↳ Continued from the preceding page.

<Applicable to GCG Series>

### 9. Selection of Conductive Adhesive, Mounting Process, and Bonding Strength

The acquired bonding strength may change greatly depending on the conductive adhesive to be used.

Be sure to confirm if the desired performance can be acquired in the assumed mounting process with the conductive adhesive to be used.

### 10. Moisture Proof Process

In order to prevent the occurrence of migration, perform a moisture proof process, such as applying a resin coating or enclosing with a dry inert gas.

### 11. Application

This product is for conductive adhesive mounting. When performing solder mounting, contact Murata in advance.

#### ■ Other

##### 1. Under Operation of Equipment

- 1-1. Do not touch a capacitor directly with bare hands during operation in order to avoid the danger of an electric shock.
- 1-2. Do not allow the terminals of a capacitor to come in contact with any conductive objects (short-circuit). Do not expose a capacitor to a conductive liquid, including any acid or alkali solutions.
- 1-3. Confirm the environment in which the equipment will operate is under the specified conditions. Do not use the equipment under the following environments.
  - (1) Being splattered with water or oil.
  - (2) Being exposed to direct sunlight.
  - (3) Being exposed to ozone, ultraviolet rays, or radiation.
  - (4) Being exposed to toxic gas (e.g., hydrogen sulfide, sulfur dioxide, chlorine, ammonia gas, etc.)
  - (5) Any vibrations or mechanical shocks exceeding the specified limits.
  - (6) Moisture condensing environments.
- 1-4. Use damp proof countermeasures if using under any conditions that can cause condensation.

##### 2. Other

- 2-1. In an Emergency
  - (1) If the equipment should generate smoke, fire, or smell, immediately turn off or unplug the equipment. If the equipment is not turned off or unplugged, the hazards may be worsened by supplying continuous power.
  - (2) In this type of situation, do not allow face and hands to come in contact with the capacitor or burns may be caused by the capacitor's high temperature.

##### 2-2. Disposal of Waste

When capacitors are disposed of, they must be burned or buried by an industrial waste vendor with the appropriate licenses.

##### 2-3. Circuit Design

- (1) Addition of Fail Safe Function  
Capacitors that are cracked by dropping or bending of the board may cause deterioration of the insulation resistance, and result in a short. If the circuit being used may cause an electrical shock, smoke or fire when a capacitor is shorted, be sure to install fail-safe functions, such as a fuse, to prevent secondary accidents.
- (2) Capacitors used to prevent electromagnetic interference in the primary AC side circuit, or as a connection/insulation, must be a safety standard certified product, or satisfy the contents stipulated in the Electrical Appliance and Material Safety Law. Install a fuse for each line in case of a short.
- (3) The GC3, GCD, GCE, GCG, GCJ, GCM, KC3, and KCM series are not safety standard certified products.

##### 2-4. Remarks

Failure to follow the cautions may result, worst case, in a short circuit and smoking when the product is used.

The above notices are for standard applications and conditions. Contact us when the products are used in special mounting conditions.

Select optimum conditions for operation as they determine the reliability of the product after assembly. The data herein are given in typical values, not guaranteed ratings.



■ Rating

1. Operating Temperature

1. The operating temperature limit depends on the capacitor.

1-1. Do not apply temperatures exceeding the upper operating temperature.

It is necessary to select a capacitor with a suitable rated temperature that will cover the operating temperature range.

It is also necessary to consider the temperature distribution in equipment and the seasonal temperature variable factor.

1-2. Consider the self-heating factor of the capacitor.

The surface temperature of the capacitor shall be the upper operating temperature or less when including the self-heating factors.

2. Atmosphere Surroundings (gaseous and liquid)

1. Restriction on the operating environment of capacitors.

1-1. Capacitors, when used in the above, unsuitable,

operating environments may deteriorate due to the corrosion of the terminations and the penetration of moisture into the capacitor.

1-2. The same phenomenon as the above may occur when the electrodes or terminals of the capacitor are subject to moisture condensation.

1-3. The deterioration of characteristics and insulation resistance due to the oxidization or corrosion of terminal electrodes may result in breakdown when the capacitor is exposed to corrosive or volatile gases or solvents for long periods of time.

3. Piezo-electric Phenomenon

1. When using high dielectric constant type capacitors in AC or pulse circuits, the capacitor itself vibrates at specific frequencies and noise may be generated. Moreover, when the mechanical vibration or shock is added to the capacitor, noise may occur.

■ Soldering and Mounting

1. PCB Design

1. Notice for Pattern Forms



1-1. Unlike leaded components, chip components are susceptible to flexing stresses since they are mounted directly on the substrate.

They are also more sensitive to mechanical and thermal stresses than leaded components.

Excess solder fillet height can multiply these stresses and cause chip cracking. When designing substrates, take land patterns and dimensions into consideration to eliminate the possibility of excess solder fillet height.

1-2. There is a possibility of chip cracking caused by PCB expansion/contraction with heat, because stress on a chip is different depending on PCB material and structure. When the thermal expansion coefficient greatly differs between the board used for mounting and the chip, it will cause cracking of the chip due to the thermal expansion and contraction. When small size capacitors of 0402 size or less are mounted on a single-layered glass epoxy board, it will also cause cracking of the chip for the same reason.

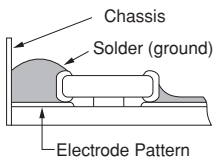
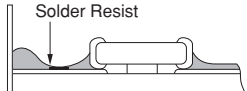
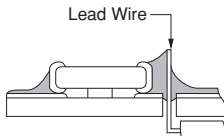
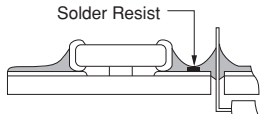
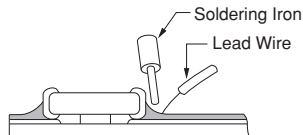
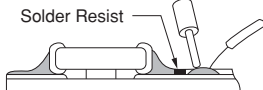
Pattern Forms

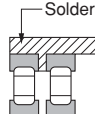
	Prohibited	Correct
Placing Close to Chassis		
Placing of Chip Components and Leaded Components		
Placing of Leaded Components after Chip Component		
Lateral Mounting		

Continued on the following page. ↗

GCM Series

GCD Series

GCE Series

GCG Series

G CJ Series

GC3 Series

KCM Series

KC3 Series

Notice

## Notice

☐ Continued from the preceding page.

### 2. Land Dimensions

2-1. Chip capacitors can be cracked due to the stress of PCB bending, etc. if the land area is larger than needed and has an excess amount of solder. Please refer to the land dimensions in table 1 for flow soldering, table 2 for reflow soldering. Please confirm the suitable land dimension by evaluating of the actual SET / PCB.

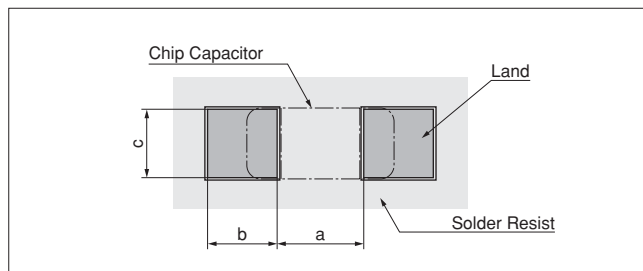

**Table 1 Flow Soldering Method**

Part Number	Dimensions	Chip (L×W)	a	b	c
<b>GC3/GCD/GCM/GCJ Series 18 size</b> (Rated Voltage: above 250VDC (for <b>GCJ</b> alone))		1.6×0.8	0.6 to 1.0	0.8 to 0.9	0.6 to 0.8
<b>GC3/GCD/GCM/GCJ Series 21 size</b> (Rated Voltage: above 250VDC (for <b>GCJ</b> alone))		2.0×1.25	1.0 to 1.2	0.9 to 1.0	0.8 to 1.1
<b>GC3/GCD/GCM/GCJ Series 31 size</b> (Rated Voltage: above 250VDC (for <b>GCJ</b> alone))		3.2×1.6	2.2 to 2.6	1.0 to 1.1	1.0 to 1.4

Flow soldering can only be used for products with a chip size from 1.6x0.8mm to 3.2x1.6mm.

(in mm)

**Table 2 Reflow Soldering Method**

Part Number	Dimensions	Chip (L×W)	a	b	c
<b>GC3/GCD/GCE/GCJ/GCM Series 03 size</b>		0.6×0.3	0.2 to 0.3	0.2 to 0.35	0.2 to 0.4
<b>GC3/GCD/GCE/GCJ/GCM Series 15 size</b>		1.0×0.5	0.3 to 0.5	0.35 to 0.45	0.4 to 0.6
<b>GQM/GR3/GRJ/GRM Series 18 size</b>		1.6×0.8	0.6 to 0.8	0.6 to 0.7	0.6 to 0.8
<b>GC3/GCD/GCE/GCJ/GCM Series 21 size</b>		2.0×1.25	1.0 to 1.2	0.6 to 0.7	0.8 to 1.1
<b>GC3/GCD/GCE/GCJ/GCM Series 31 size</b>		3.2×1.6	2.2 to 2.4	0.8 to 0.9	1.0 to 1.4
<b>GC3/GCD/GCE/GCJ/GCM Series 32 size</b>		3.2×2.5	2.0 to 2.4	1.0 to 1.2	1.8 to 2.3
<b>GC3/GCD/GCE/GCJ/GCM Series 43 size</b>		4.5×3.2	3.0 to 3.5	1.2 to 1.4	2.3 to 3.0
<b>GC3/GCD/GCE/GCJ/GCM Series 55 size</b>		5.7×5.0	4.0 to 4.6	1.4 to 1.6	3.5 to 4.8

(in mm)

<Applicable to Part Number KC3/KCM>

Part Number	Dimensions	Chip (L×W)	a	b	c
<b>KC3/KCM Series 55 size</b>		5.7×5.0	2.6	2.7	5.6

(in mm)

<Applicable to beyond Rated Voltage of 250VDC>

### 2-2. Dimensions of Slit (Example)

Preparing the slit helps flux cleaning and resin coating on the back of the capacitor. However, the length of the slit design should be as short as possible to prevent mechanical damage in the capacitor.

A longer slit design might receive more severe mechanical stress from the PCB. Recommended slit design is shown in the Table.

L×W	d	e
1.6×0.8	—	—
2.0×1.25	—	—
3.2×1.6	1.0 to 2.0	3.2 to 3.7
3.2×2.5	1.0 to 2.0	4.1 to 4.6
4.5×2.0	1.0 to 2.8	3.6 to 4.1
4.5×3.2	1.0 to 2.8	4.8 to 5.3
5.7×2.8	1.0 to 4.0	4.4 to 4.9
5.7×5.0	1.0 to 4.0	6.6 to 7.1

(in mm)

Continued on the following page. ↗

Continued from the preceding page.

### 3. Board Design

When designing the board, keep in mind that the amount of strain which occurs will increase depending on the size and material of the board.

[Relationship with amount of strain to the board thickness, length, width, etc.]

$$\epsilon = \frac{3PL}{2Ewh^2}$$

Relationship between load and strain

- ε: Strain on center of board (μst)
- L: Distance between supporting points (mm)
- w: Board width (mm)
- h: Board thickness (mm)
- E: Elastic modulus of board (N/m<sup>2</sup>=Pa)
- Y: Deflection (mm)
- P: Load (N)

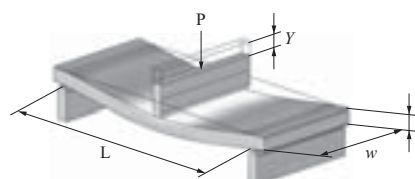

When the load is constant, the following relationship can be established.

- As the distance between the supporting points (L) increases, the amount of strain also increases.  
→Reduce the distance between the supporting points.
  - As the elastic modulus (E) decreases, the amount of strain increases.  
→Increase the elastic modulus.
  - As the board width (w) decreases, the amount of strain increases.  
→Increase the width of the board.
  - As the board thickness (h) decreases, the amount of strain increases.  
→Increase the thickness of the board.
- Since the board thickness is squared, the effect on the amount of strain becomes even greater.

### 2. Adhesive Application

1. Thin or insufficient adhesive can cause the chips to loosen or become disconnected during flow soldering. The amount of adhesive must be more than dimension c, shown in the drawing at right, to obtain the correct bonding strength.

The chip's electrode thickness and land thickness must also be taken into consideration.

2. Low viscosity adhesive can cause chips to slip after mounting. The adhesive must have a viscosity of 5000Pa · s (500ps) min. (at 25°C).

### 3. Adhesive Coverage

Size (L×W) (in mm)	Adhesive Coverage*
1.6×0.8	0.05mg min.
2.0×1.25	0.1mg min.
3.2×1.6	0.15mg min.

\*Nominal Value

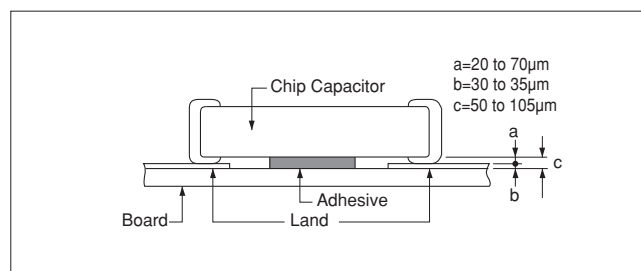

### 3. Adhesive Curing

1. Insufficient curing of the adhesive can cause chips to disconnect during flow soldering and causes deterioration in the insulation resistance between the outer electrodes due to moisture absorption.

Control curing temperature and time in order to prevent insufficient hardening.

Continued on the following page. ↗

## Notice

☐ Continued from the preceding page.

### 4. Flux for Reflow and Flow Soldering

1. An excessive amount of flux generates a large quantity of flux gas, which can cause a deterioration of solder ability, so apply flux thinly and evenly throughout. (A foaming system is generally used for flow soldering.)
2. Flux containing too high a percentage of halide may cause corrosion of the outer electrodes unless there is sufficient cleaning. Use flux with a halide content of 0.1% max.

### 5. Flow Soldering

- Set temperature and time to ensure that leaching of the outer electrode does not exceed 25% of the chip end area as a single chip (full length of the edge A-B-C-D shown at right) and 25% of the length A-B shown as mounted on substrate.

3. Do not use strong acidic flux.
4. Do not use water-soluble flux.\*  
(\*Water-soluble flux can be defined as non-rosin type flux including wash-type flux and non-wash-type flux.)

[As a Single Chip]

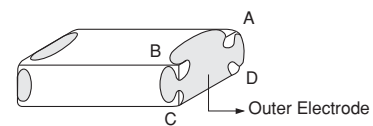

[As Mounted on Substrate]

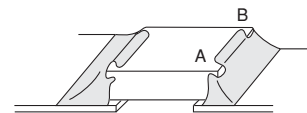

### 6. Washing

1. Please evaluate the capacitor using actual cleaning equipment and conditions to confirm the quality, and select the solvent for cleaning.
2. Unsuitable cleaning solvent may leave residual flux or other foreign substances, causing deterioration of electrical characteristics and the reliability of the capacitors.

3. Select the proper cleaning conditions.  
3-1. Improper cleaning conditions (excessive or insufficient) may result in deterioration of the performance of the capacitors.

### 7. Coating

1. A crack may be caused in the capacitor due to the stress of the thermal contraction of the resin during curing process.  
The stress is affected by the amount of resin and curing contraction.  
Select a resin with low curing contraction.  
The difference in the thermal expansion coefficient between a coating resin or a molding resin and the capacitor may cause the destruction and deterioration of the capacitor such as a crack or peeling, and lead to the deterioration of insulation resistance or dielectric breakdown.  
Select a resin for which the thermal expansion coefficient is as close to that of the capacitor as possible.  
A silicone resin can be used as an under-coating to buffer against the stress.

2. Select a resin that is less hygroscopic.  
Using hygroscopic resins under high humidity conditions may cause the deterioration of the insulation resistance of a capacitor.  
An epoxy resin can be used as a less hygroscopic resin.

Continued on the following page. ☐

☐ Continued from the preceding page.

■ Other

1. Transportation

1. The performance of a capacitor may be affected by the conditions during transportation.
  - 1-1. The capacitors shall be protected against excessive temperature, humidity, and mechanical force during transportation.
    - (1) Climatic condition
      - low air temperature: -40°C
      - change of temperature air/air: -25°C/+25°C
      - low air pressure: 30 kPa
      - change of air pressure: 6 kPa/min.
    - (2) Mechanical condition  
Transportation shall be done in such a way that the boxes are not deformed and forces are not directly passed on to the inner packaging.
  - 1-2. Do not apply excessive vibration, shock, or pressure to the capacitor.
    - (1) When excessive mechanical shock or pressure is applied to a capacitor, chipping or cracking may occur in the ceramic body of the capacitor.
    - (2) When the sharp edge of an air driver, a soldering iron, tweezers, a chassis, etc. impacts strongly on the surface of the capacitor, the capacitor may crack and short-circuit.
  - 1-3. Do not use a capacitor to which excessive shock was applied by dropping, etc.  
A capacitor dropped accidentally during processing may be damaged.

2. Characteristics Evaluation in the Actual System

1. Evaluate the capacitor in the actual system, to confirm that there is no problem with the performance and specification values in a finished product before using.
2. Since a voltage dependency and temperature dependency exists in the capacitance of high dielectric type ceramic capacitors, the capacitance may change depending on the operating conditions in the actual system. Therefore, be sure to evaluate the various characteristics, such as the leakage current and noise absorptivity, which will affect the capacitance value of the capacitor.
3. In addition, voltages exceeding the predetermined surge may be applied to the capacitor by the inductance in the actual system. Evaluate the surge resistance in the actual system as required.

GCM Series

GCD Series

GCE Series

GCG Series

GCJ Series

GC3 Series

KCM Series

KC3 Series

Notice

# Design assistant tool: SimSurfing SimSurfing

## MLCC is now available !

Design assistant tool "SimSurfing" has been updated and you can now find and view any kind of characteristics of MLCCs.

### Available function for MLCCs:

- ① Products search
- ② View frequency characteristics (S parameters, Z, R, X, Q, DF, L, C)  
DC bias can be applied to available part number.
- ③ DC voltage bias characteristics (absolute capacitance/change rate)
- ④ Temperature characteristics (absolute capacitance/change rate)
- ⑤ AC voltage bias characteristics (absolute capacitance/change rate)
- ⑥ Download SPICE netlist/ S parameter

### 1 Select the Products

- (1) By part number
- (2) By specification

### 2 View characteristics

By clicking buttons in this area with part number selected, you can view any electrical characteristics chart.

### 3 Data download

You can download SPICE netlist and S parameter files (S2P)



Added the capacitor finder tool for middle and high voltage capacitor which are capable for specified voltage waveform.

These images are captured at May/2013. Be sure that this software will be updated frequently.

<http://ds.murata.com/software/simsurfing/en-us/mlcc/>

# EMICON-FUN!

Please check Murata's newsletter!  
 You can learn about electric parts with fun.  
[http://www.murata.com/products/emicon\\_fun/](http://www.murata.com/products/emicon_fun/)

EMICON-FUN! disseminated widely from basics (principles, characteristics, mounting, etc.) of capacitors, inductors and EMI suppression filters to information can practically be used.  
 Updated information is also distributed via the mail magazine.

**Click here to register as reader → [http://go.murata.co.jp/Email\\_Newsletter\\_EN.html](http://go.murata.co.jp/Email_Newsletter_EN.html)**

You can register from the Products page on Murata Manufacturing website.  
<http://www.murata.com/products/>



← This banner is the entrance of register form

**Capacitor Room**

- Technical Report Evolving Capacitors - Monolithic Ceramic Capacitors - Part 1 Trend (part 2/2)
- Technical Report Evolving Capacitors - Monolithic Ceramic Capacitors Part 1 Trend (part 1 of 2)
- Monolithic Ceramic Capacitor QCC Series for Conductive Adhesives
- DEH series lead-type monolithic ceramic capacitors compatible to 150°C for automotive applications
- What kind of layout helps prevent chip monolithic ceramic capacitor from cracking?

**Noise suppression filter Room**

- Basics of Noise Countermeasures Lesson 12: How to Make the Best Use of LC Component-type EMI filters
- Basics of Noise Countermeasures Lesson 11: Notes on the Use of Chip 3-Terminal Capacitors
- Basics of Noise Countermeasures Lesson 10: Precautions for Using Chip Ferrite Beads
- Why is differential transmission used for high-speed transmission?
- Birth of the TEM-3 series chip ferrite beads: Entering unexplored SCS territory

**Inductor Room**

- World's highest inductance value! Expanded lineup of ultra-compact Q3H-series (SMD/lead)-size high-frequency chip inductors for smartphones -the LQP01TH (Q) series-
- Assessing inductor development [No. 7] Days worrying about high-frequency high-speed measurement technology
- Assessing inductor development [No. 6] The new product inspired by a swing!
- Assessing inductor development [No. 5] Trends in LQH solder mounting technology
- Assessing inductor development [No. 4] Japan's first air-core horizontal wire-wound coil

**For the EARTH**

- Introducing Murata's school classes: What we can do for the children who will shape the earth's future
- Special Feature on the Environment, Part 3 "Toward a Low-carbon Society - Initiatives for Global Warming Prevention."

**Sample Newsletter Content:**

muRata Newsletter "EMICON-FUN!"

☆TOPICS☆

- 1) Capacitor Room
- 2) Product News
- 3) Industry Pickup - Smart Phones
- 4) Application Examples - Inductors - Mobile Phones (SAW Filter)

1) Capacitor Room  
 Evolving Capacitors - Monolithic Ceramic Capacitors - Part 1 Trend (part 2/2) \*.\*.\*

This article is a continuation of "Evolving Capacitors: Monolithic Ceramic Capacitors, Part 1 Trends (part 1/2)". In the second part, we discuss monolithic ceramic capacitor applications. Decoupling and smoothing filter applications account for about 70% of the monolithic ceramic capacitor market. Other typical applications include high-frequency filters, impedance matching, and temperature compensation. [Click here](#)

2) Product News \*.\*.\*

- High temperature guaranteed low loss lead type ceramic capacitor <DEH Series>

1. This is a low loss product suitable for high frequency pulse and high voltage applications, such as a snubber circuit of power circuits.
2. Coated with a flame-retardant epoxy resin (equivalent to UL94V-0), and guaranteed operating temperature up to 125°C.

# Capacitor Website Introduction

The website and search engine of ceramic capacitors has been drastically renewed.

capacitor murata

<http://www.murata.com/products/capacitor/>

The screenshot shows the Murata website interface for ceramic capacitors. The page is titled "Capacitors" and features a navigation menu with "News", "Products", "About MURATA", and "Investor Relations". A search bar is located in the top right corner.

Key features highlighted with numbered callouts:

- 1 Search by features**: Search by problems of noise, cracks etc., or mounting methods.
- 2 Search in the lineups**: Search by entire product lineup.
- 3 Search by specifications**: Search by capacitance, rated voltage, or temperature characteristics.
- 4 Cross-reference search**: Search for equivalent products for competitor's part numbers.
- 5 Search by part number**: Search by part number with options for "Starting with" and "Including", and checkboxes for "Include discontinued/planned discontinued".

Other sections visible on the page include:

- Examples of Problem Solving**: Offering customer's problems, Examples of Replacements (Video), Proposal for Cost Reductions.
- Industry Pickup**: Introducing the recommended series and the latest information in Murata for each industry (Automobile, Smart Phones).
- Advantages of Murata Capacitors**: Pioneer of monolithic ceramic capacitor manufacturing, continuing to evolve as the world's No. 1 manufacturer.
- Design Tools**: Software Tools (Including WEB), 2 parameter, SPICE Model, Libraries.
- Frequently Asked Questions (FAQ)**: Monolithic Ceramic Capacitors, Polymer Capacitors, Trimmer Capacitors.
- Product Data**: The electrical characteristic data and reliability test data of typical items can be viewed as PDF. Characteristics Data, Reliability Test Data.
- Part Certified Materials**: Material required when the customer acknowledges Murata's parts. Safety Certificates by Series.
- Environmental Protection Measures**: Our product development efforts take the environment into consideration. Lot of ISO14001 Certified Plants.

At the bottom, there is a "New Products" section with a table of recent updates:

Date	Product Line	Technical Information	EMCON-FUN
Apr 10, 2014	New Monolithic Ceramic Capacitors E201 Size (0.6x0.3mm), 0.1µF Available, with Guaranteed Operating Temperature of 125°C with 10V		
Apr 10, 2014	New Monolithic Ceramic Capacitors S201 Size (2.0x1.25mm), 10µF Available, with Guaranteed Operating Temperature of 125°C with 25V		
Mar 24, 2014	The Capacity Lossing of Temperature Compensation - Type Monolithic Ceramic Capacitors (E201 size) Expanded!		
Mar 3, 2014	The Capacity Lossing of MLCC with Guaranteed Operating Temperature of 125°C		



# Global Locations

For details please visit [www.murata.com](http://www.murata.com)

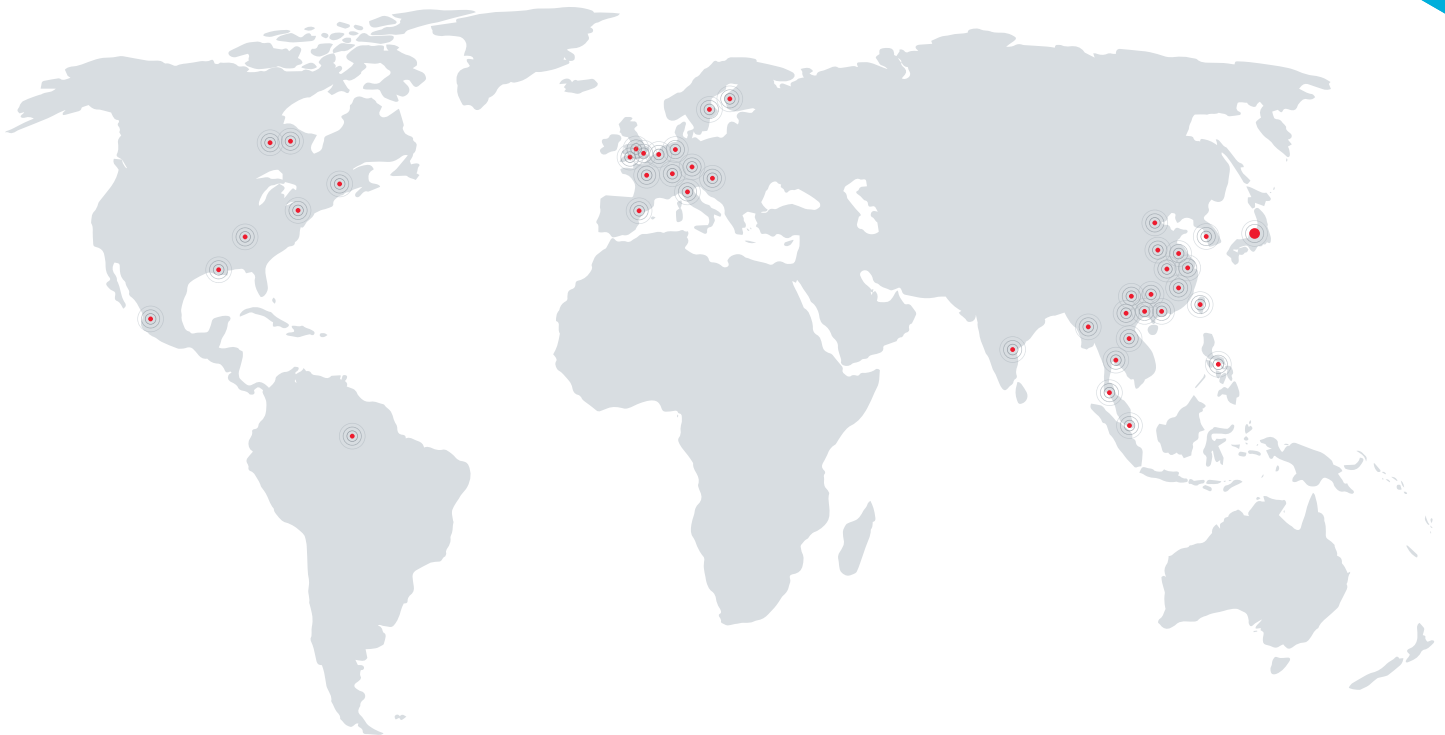

## ⚠ Note

### 1 Export Control

#### For customers outside Japan:

No Murata products should be used or sold, through any channels, for use in the design, development, production, utilization, maintenance or operation of, or otherwise contribution to (1) any weapons (Weapons of Mass Destruction [nuclear, chemical or biological weapons or missiles] or conventional weapons) or (2) goods or systems specially designed or intended for military end-use or utilization by military end-users.

#### For customers in Japan:

For products which are controlled items subject to the "Foreign Exchange and Foreign Trade Law" of Japan, the export license specified by the law is required for export.

2 Please contact our sales representatives or product engineers before using the products in this catalog for the applications listed below, which require especially high reliability for the prevention of defects which might directly damage a third party's life, body or property, or when one of our products is intended for use in applications other than those specified in this catalog.

- ① Aircraft equipment
- ② Aerospace equipment
- ③ Undersea equipment
- ④ Power plant equipment
- ⑤ Medical equipment
- ⑥ Transportation equipment (vehicles, trains, ships, etc.)
- ⑦ Traffic signal equipment
- ⑧ Disaster prevention / crime prevention equipment
- ⑨ Data-processing equipment
- ⑩ Application of similar complexity and/or reliability requirements to the applications listed above

3 Product specifications in this catalog are as of March 2014. They are subject to change or our products in it may be discontinued without advance notice. Please check with our sales representatives or product engineers before ordering. If there are any questions, please contact our sales representatives or product engineers.

4 Please read rating and ⚠CAUTION (for storage, operating, rating, soldering, mounting and handling) in this catalog to prevent smoking and/or burning, etc.

5 This catalog has only typical specifications. Therefore, please approve our product specifications or transact the approval sheet for product specifications before ordering.

6 Please note that unless otherwise specified, we shall assume no responsibility whatsoever for any conflict or dispute that may occur in connection with the effect of our and/or a third party's intellectual property rights and other related rights in consideration of your use of our products and/or information described or contained in our catalogs. In this connection, no representation shall be made to the effect that any third parties are authorized to use the rights mentioned above under licenses without our consent.

7 No ozone depleting substances (ODS) under the Montreal Protocol are used in our manufacturing process.

Murata Manufacturing Co., Ltd.

[www.murata.com](http://www.murata.com)

**muRata**  
INNOVATOR IN ELECTRONICS

## X-ON Electronics

Largest Supplier of Electrical and Electronic Components

*Click to view similar products for [Multilayer Ceramic Capacitors MLCC - SMD/SMT](#) category:*

*Click to view products by [Murata](#) manufacturer:*

Other Similar products are found below :

[M39014/01-1467](#) [M39014/02-1218V](#) [M39014/02-1225V](#) [M39014/02-1262V](#) [M39014/02-1301](#) [M39014/22-0631](#) [1210J5000102JCT](#)  
[1210J2K00102KXT](#) [1210J5000103KXT](#) [1210J5000223KXT](#) [D55342E07B379BR-TR](#) [D55342E07B523DR-T/R](#) [1812J1K00103KXT](#)  
[1812J1K00473KXT](#) [1812J2K00680JCT](#) [1812J4K00102MXT](#) [1812J5000102JCT](#) [1812J5000103JCT](#) [1812J5000682JCT](#) [NIN-FB391JTRF](#)  
[NIN-FC2R7JTRF](#) [NPIS27H102MTRF](#) [C1206C101J1GAC](#) [C1608C0G1E472JT000N](#) [C2012C0G2A472J](#) [2220J2K00101JCT](#)  
[KHC201E225M76N0T00](#) [LRC-LRF1206LF-01R025FTR1K](#) [1812J1K00222JCT](#) [1812J2K00102KXT](#) [1812J2K00222KXT](#)  
[1812J2K00472KXT](#) [2-1622820-7-CUT-TAPE](#) [2220J3K00102KXT](#) [2225J2500824KXT](#) [CCR07CG103KM](#) [CGA2B2C0G1H010C](#)  
[CGA2B2C0G1H040C](#) [CGA2B2C0G1H050C](#) [CGA2B2C0G1H060D](#) [CGA2B2C0G1H070D](#) [CGA2B2C0G1H151J](#) [CGA2B2C0G1H1R5C](#)  
[CGA2B2C0G1H2R2C](#) [CGA2B2C0G1H3R3C](#) [CGA2B2C0G1H680J](#) [CGA2B2C0G1H6R8D](#) [CGA2B2X8R1H221K](#) [CGA2B2X8R1H472K](#)  
[CGA3E1X7R1C474K](#)