

Designed to comply with physical, electrical and environmental requirements of micro USB Standard Compliance (USB3.0).

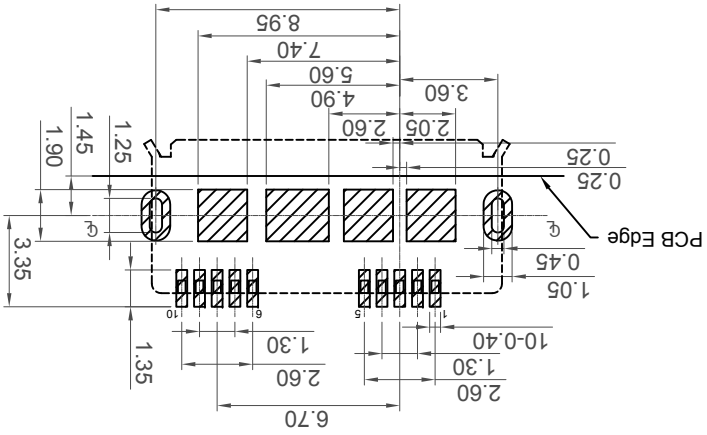
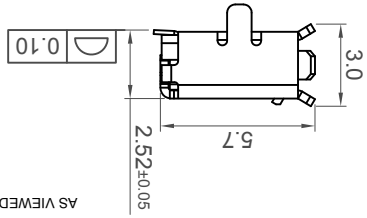
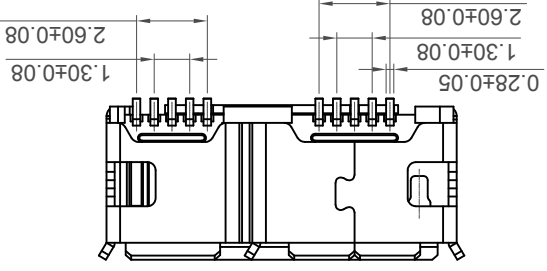
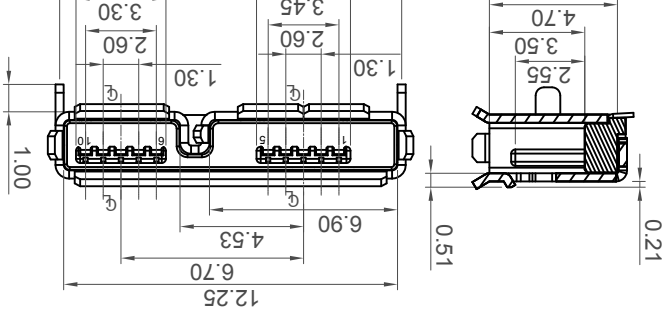
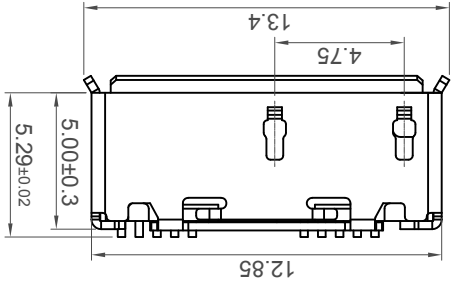

RECOMMENDED P.C.B LAYOUT  
 GENERAL TOLERANCE: ±0.05  
 AS VIEWED FROM COMPONENT SIDE  
 Solder Area  
 Component Outline

PIN NUMBER	SIGNAL NAME	DESCRIPTION	MATING SEQUENCE
1	VBUS	Power	Second
2	D-	USB 2.0 Differential pair	Last
3	D+		
4	ID	OTG identification	Second
5	GND	Ground for power return	
6	MicA_SSRX-	SuperSpeed receiver differential pair	Last
7	MicA_SSRX+		
8	GND_DRAIN	Ground for SuperSpeed signal return	Second
9	MicA_SSTX-	SuperSpeed transmitter differential pair	
10	MicA_SSTX+		
Shield		Connector metal shell	First

**Specifications 规格:**  
 Materials 材料: Plastic Housing 塑胶外壳: LCP, UL94V-0, Black, LCP, UL94V-0 黑色  
 Contact Terminal 接触端子: Copper Alloy 铜合金  
 Metallic Shell 金属外壳: Stainless Steel 不锈钢  
 Finish 表面处理: Underplating 底层电镀: Nickel  
 Plating 电镀: Contact Area 接触面积: 30µ" Gold  
 Solder Tails 焊接末端: Gold Flash  
 Metallic Shell 金属外壳: Tin  
**Electrical 电气规格:**  
 Voltage Rating 电压额定值: 100 V AC/DC  
 Current Rating 电流额定值:  
 Signal Pins 信号引脚 2,3,4,6,7,8,9,10 at 0.25A AC/DC & Power Pins 电源引脚 1,5 at 1.8A AC/DC  
 Operating Temperature 工作温度: -30°C to +85°C  
 Contact Resistance 接触电阻值: 30mΩ Max.  
 Insulating Resistance 绝缘电阻值: 1000MΩ Min.  
 Dielectric Withstand Voltage 耐电压: 100V AC/Minute  
 Mechanical 机械性规格:  
 Mating Force 插入力: 35N Max.  
 Unmating Force 拔出力: 10N Min.  
 Durability 耐久性: 10000

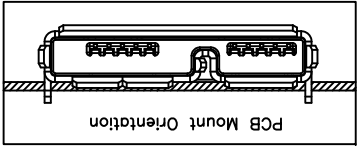
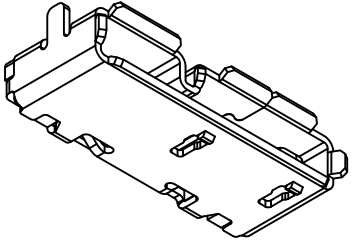

Ordering Grid  
 USB3120-30-A  
 Contact Plating 30 = 30µ" Gold  
 Packing Options A = Tape & Reel  
 REQUEST SAMPLES AND QUOTATION



Tolerances (Excerpt as noted)	Part Number	Date
Dimensions in mm	USB3120	16 MAY 11
Description	USB 3.0 Micro Receptacle, Type AB, SMT, Horizontal, 10 Pin, Bottom Mount, with Outer Shell Stakes	

Sheet No.	1/2
E & OE	8
Drawn by	ASE
Material	See Note
Revision	D
Scale	NTS
THIS DRAWING IS CONFIDENTIAL AND MUST NOT BE COPIED OR DISCLOSED WITHOUT WRITTEN CONSENT	

GCT  
 www.gct.co

By	AJO
DETAIL	USB3120
REV	D
DATE	06/06/14

By	AJO
DETAIL	USB3120
REV	D
DATE	06/06/14



Tolerances	Part Number	Date
Dimensions in mm (except as noted)	USB3120	16 MAY 11
Description	USB 3.0 Micro Receptacle, Type AB, SMT, Horizontal, 10 Pin, Bottom Mount, with Outer Shell Stakes	
Third Angle Projection	THIS DRAWING IS CONFIDENTIAL AND MUST NOT BE COPIED OR DISCLOSED WITHOUT WRITTEN CONSENT	

Scale	Revision	Material	Drawn by	E & OE	Sheet No.
NTS	D	See Note	ASE	22	8
www.gct.co					
<b>GCT</b>					

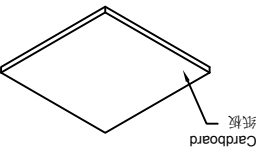
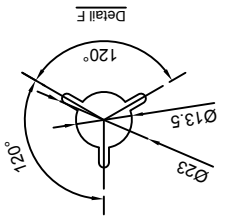
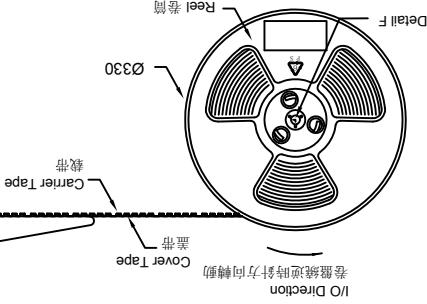
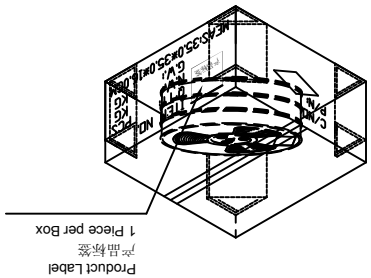
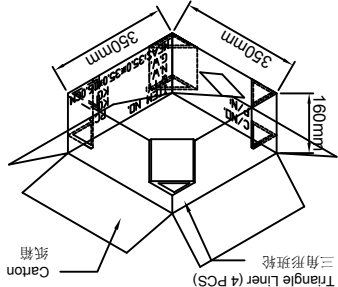
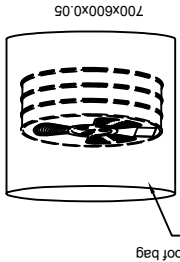
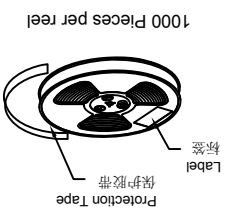

Notes注意:  
1. Peeling off force of top tape: 0.1-1.3N  
2. All dimensions in millimeters 所有尺寸均是毫米

Products P/N	PCS/Reel	Reels/Carton	PCS/Carton
USB3120-30-A	1000	3	3000

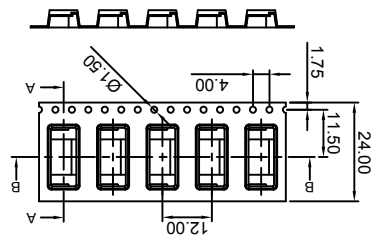
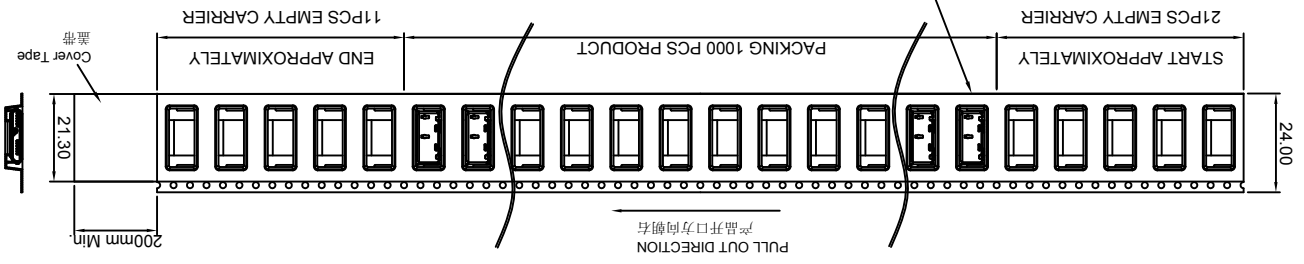

## X-ON Electronics

Largest Supplier of Electrical and Electronic Components

*Click to view similar products for [get manufacturer:](#)*

Other Similar products are found below :

[BG302-03-A-L-G](#) [BD021-09A-A1-0350-0200-0550-LD](#) [BG095-10-A-N-D](#) [SIM7200-6-0-18-00-A](#) [BG165-04-A-A-N-H](#) [BC070-06-A-1-L-D](#)  
[BG120-10-A-0-N-D](#) [SIM7050-8-0-00-A](#) [BF020-03-A-B-0600-0300-N-G](#) [DCJ250-15-A-K1-C](#) [BG030-06-A-0450-0300-N-G](#) [DCJ065-05-A-K1-A](#) [USB4085-GF-A](#) [BC085-08-A-0390-L-D](#) [BC034-10-A-V-0150-L-D](#) [BG300-06-A-L-A](#) [BG301-02-A-0540-L-B](#) [BG095-07-A-N-D](#)  
[BG040-06-A-0450-0300-N-G](#) [BG030-04-A-0450-0300-N-G](#) [BG303-04-A-0300-L-G](#) [DCJ235-05-A-K1-K](#) [BG301-05-A-0540-L-B](#) [BC050-06A-K0-0200-0160-0480-LG](#) [MEM2075-00-140-01-A](#) [USB4055-30-A](#) [BG055-04A-1-0450-0530-0350-L-G](#) [BC050-10A-K0-0200-0160-0480-LD](#) [BC070-20-A-1-L-D](#) [BD020-10-A-J-0350-0300-L-G](#) [MEM2067-02-180-00-A](#) [USB3105-30-A](#) [BG120-04-A-0-N-D](#) [BC085-06-A-0390-L-D](#) [BC050-08A-K0-0200-0160-0480-LG](#) [BC050-14A-K0-0200-0160-0480-LD](#) [DCJ250-10-A-K1-K](#) [BG302-05-A-L-G](#) [USB4065-30-A](#)  
[USB1035-GF-P-0-B-B](#) [BF085-02-A-0240-N-G](#) [BG050-10A-0-0450-0737-0350-L-D](#) [BG302-04-A-L-G](#) [BG055-03A-1-0650-0530-0350-L-G](#)  
[BC075-08-A-L-D](#) [BC032-06-A-2-0200-0200-L-D](#) [BF020-02-A-B-0400-0300-N-G](#) [BD020-03-A-J-0350-0300-L-G](#) [BC050-12A-K0-0200-0160-0480-LD](#) [USB3160-30-0170-1-C](#)