

Designed to comply with physical, electrical and environmental requirements of micro USB Standard Compliance (USB3.0).

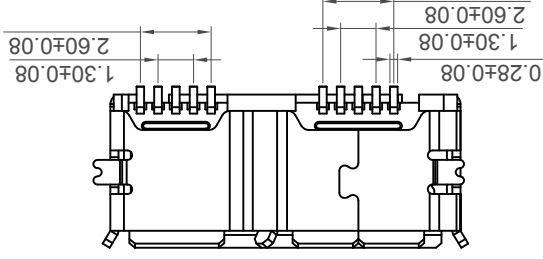
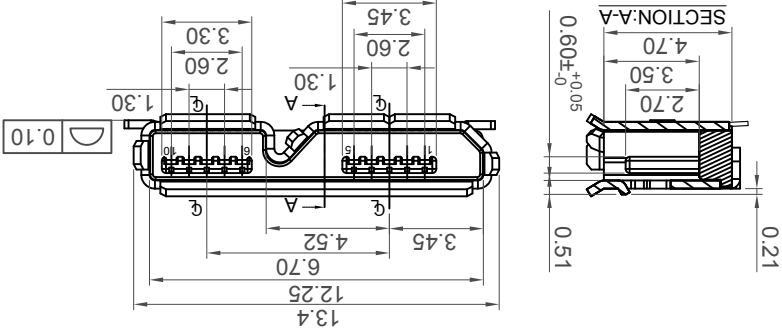
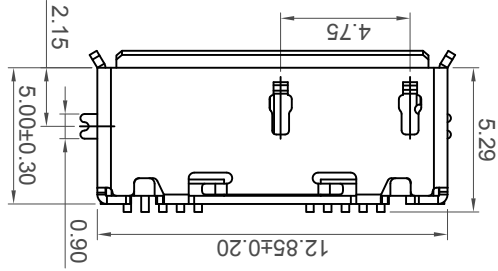

Ordering Grd
USB3115-30
 Contact Plating 30 = 30µ" Gold
 Packing Options
 A = Tape & Reel
 Request Samples and Quotation
 (1000 per Reel)

By	AJO
DETAIL	USB3115
REV	G
DATE	06/08/14

PIN NUMBER	SIGNAL NAME	DESCRIPTION
1	VBUS	Power
2	D-	USB 2.0 Differential pair
3	D+	USB 2.0 Differential pair
4	ID	OTG identification
5	GND	Ground for power return
6	MicB_SSTX-	SuperSpeed transmitter
7	MicB_SSTX+	differential pair
8	GND_DRAIN	Ground for SuperSpeed signal return
9	MicB_SSRX-	SuperSpeed receiver
10	MicB_SSRX+	differential pair
	Shield	Connector metal shell

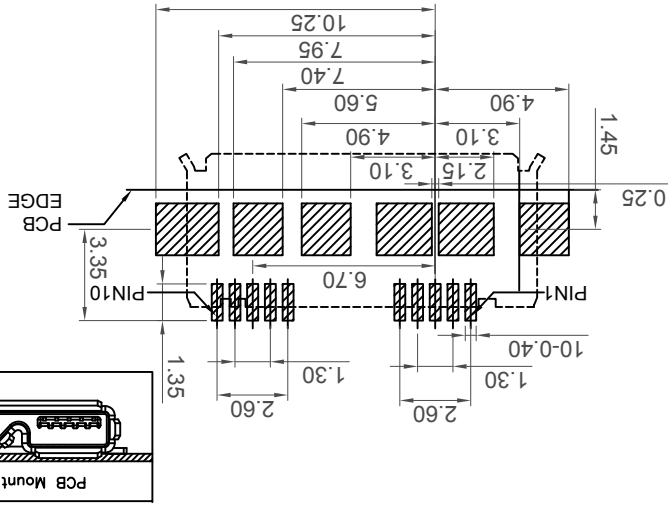

RECOMMENDED P.C.B LAYOUT
 AS VIEWED FROM COMPONENT SIDE
 Solder Area Solder Area Component Outline

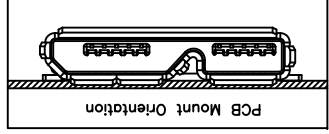
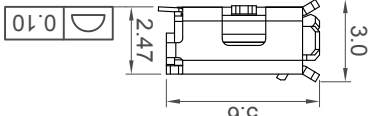

Specifications 规格:

Materials 材料:
 Plastic Housing 塑胶外壳: LCP, UL94V-0, 黑色
 Black, LCP, UL94V-0 黑色
 Contact Terminal 接触端子: Copper Alloy 铜合金
 Metallic Shell 金属外壳: Stainless Steel 不锈钢
 Finish 表面处理:
 Underplating 底层电镀: Nickel
 Plating 电镀:
 Contact Area 接触面积: 30µ" Gold
 Solder Tails 焊接末端: Gold Flash
 Metallic Shell 金属外壳: Tin

Electrical 电气规格:
 Voltage Rating 电压额定值: 100 V AC/DC
 Current Rating 电流额定值:
 Signal Pins 信号引脚 2,3,4,6,7,8,9,10 在 0.25A AC/DC
 & Power Pins 电源引脚 1,5 在 1.8A AC/DC

Operating Temperature 工作温度: -30°C to +85°C
 Contact Resistance 接触电阻值: 30mΩ Max.
 Insulating Resistance 绝缘电阻值: 1000MΩ Min.
 Dielectric Withstand Voltage 耐电压: 100V AC/Minute
 Mechanical 机械性规格:
 Mating Force 插入力: 35N Max.
 Unmating Force 拔出力: 10N Min.
 Durability 耐久性: 10000

Part Number:-	USB3115	Date:-	16 MAY 11
Tolerances	(Except as noted)		
Dimensions in mm	X.X ± 0.3 X.X° ± 2° X.XX ± 0.2 X.XXX ± 0.1 X.XXX ± 0.5		
Description:-	USB 3.0 Micro Receptacle, Type B, SMT, Horizontal, 10 Pin, Bottom Mount, with SMT Holdown Pads		
THIS DRAWING IS CONFIDENTIAL AND MUST NOT BE COPIED OR DISCLOSED WITHOUT WRITTEN CONSENT			
Scale	NTS	Revision	G
Material	See Note	Drawn by	ASE
Sheet No.	1/2	E & OE	8

GCT
 www.gct.co



Third Angle Projection

By	AJO
DETAIL	USB3115
REV	G
DATE	06/06/14

Deca-BDE
COMPLIANT
2011/65/EU
ROHS

Tolerances	Part Number:-	Date:-
Dimensions in mm (Except as noted)	USB3115	16 MAY 11
Description:-	USB 3.0 Micro Receptacle, Type B, SMT, Horizontal, 10 Pin, Bottom Mount, with SMT Holdown Pads	

THIS DRAWING IS CONFIDENTIAL AND MUST NOT BE COPIED OR DISCLOSED WITHOUT WRITTEN CONSENT	Scale	Revision	Material	Drawn by	E & OE	Sheet No.
	NTS	G	See Note	ASE		2/2
GCT www.gct.co						

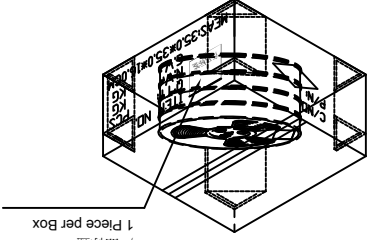
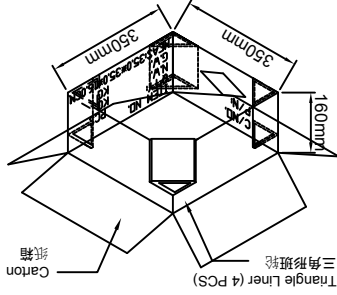
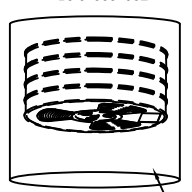
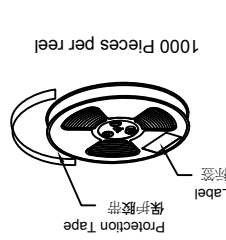
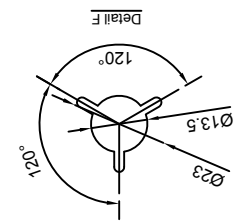
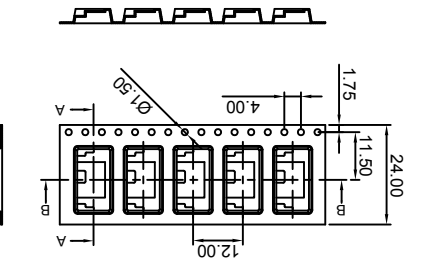
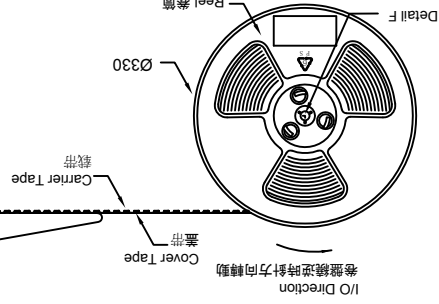

Notes: 注意:
1. Peeling off force of top tape: 0.1-1.3N
2. All dimensions in millimeters. 所有尺寸均是毫米

Products P/N	PCS/Reel	Reels/Carton	PCs/Carton
USB3115-30-A	1000	4	4000

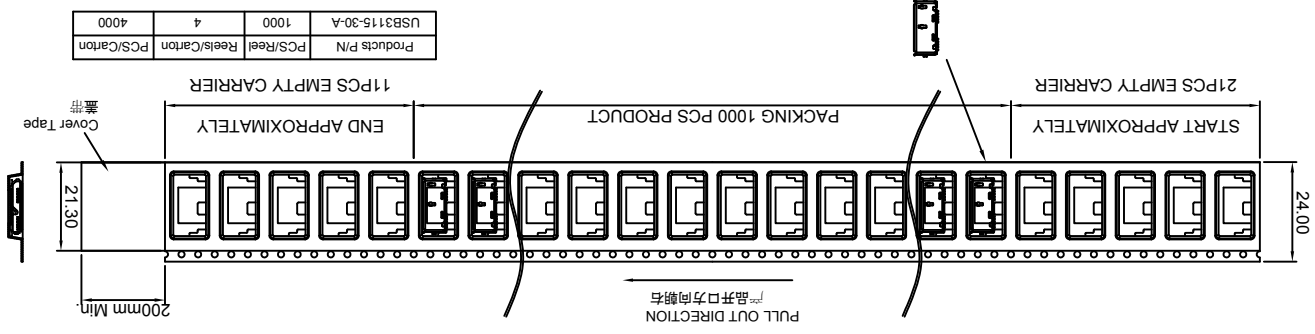

X-ON Electronics

Largest Supplier of Electrical and Electronic Components

Click to view similar products for [get manufacturer:](#)

Other Similar products are found below :

[BG302-03-A-L-G](#) [BD021-09A-A1-0350-0200-0550-LD](#) [BG095-10-A-N-D](#) [SIM7200-6-0-18-00-A](#) [BG165-04-A-A-N-H](#) [BC070-06-A-1-L-D](#)
[BG120-10-A-0-N-D](#) [SIM7050-8-0-00-A](#) [BF020-03-A-B-0600-0300-N-G](#) [DCJ250-15-A-K1-C](#) [BG030-06-A-0450-0300-N-G](#) [DCJ065-05-A-K1-A](#) [USB4085-GF-A](#) [BC085-08-A-0390-L-D](#) [BC034-10-A-V-0150-L-D](#) [BG300-06-A-L-A](#) [BG301-02-A-0540-L-B](#) [BG095-07-A-N-D](#)
[BG040-06-A-0450-0300-N-G](#) [BG030-04-A-0450-0300-N-G](#) [BG303-04-A-0300-L-G](#) [DCJ235-05-A-K1-K](#) [BG301-05-A-0540-L-B](#) [BC050-06A-K0-0200-0160-0480-LG](#) [MEM2075-00-140-01-A](#) [USB4055-30-A](#) [BG055-04A-1-0450-0530-0350-L-G](#) [BC050-10A-K0-0200-0160-0480-LD](#) [BC070-20-A-1-L-D](#) [BD020-10-A-J-0350-0300-L-G](#) [MEM2067-02-180-00-A](#) [USB3105-30-A](#) [BG120-04-A-0-N-D](#) [BC085-06-A-0390-L-D](#) [BC050-08A-K0-0200-0160-0480-LG](#) [BC050-14A-K0-0200-0160-0480-LD](#) [DCJ250-10-A-K1-K](#) [BG302-05-A-L-G](#) [USB4065-30-A](#)
[USB1035-GF-P-0-B-B](#) [BF085-02-A-0240-N-G](#) [BG050-10A-0-0450-0737-0350-L-D](#) [BG302-04-A-L-G](#) [BG055-03A-1-0650-0530-0350-L-G](#)
[BC075-08-A-L-D](#) [BC032-06-A-2-0200-0200-L-D](#) [BF020-02-A-B-0400-0300-N-G](#) [BD020-03-A-J-0350-0300-L-G](#) [BC050-12A-K0-0200-0160-0480-LD](#) [USB3160-30-0170-1-C](#)