

mikroPASCAL for 8051

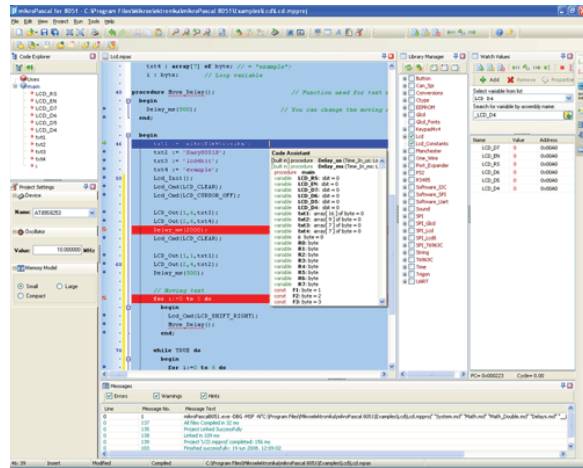
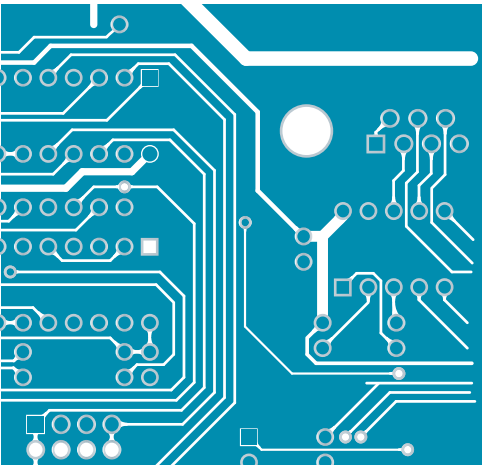

Develop your applications quickly and easily with the world's most intuitive mikroPASCAL for 8051 Microcontrollers.

Highly sophisticated IDE provides the power you need with the simplicity of a Windows based point-and-click environment.

With useful implemented tools, many practical code examples, broad set of built-in routines, and a comprehensive Help, mikroPASCAL for 8051 makes a fast and reliable tool, which can satisfy needs of experienced engineers and beginners alike.

January 2009.

Reader's note

DISCLAIMER:

mikroPascal for 8051 and this manual are owned by mikroElektronika and are protected by copyright law and international copyright treaty. Therefore, you should treat this manual like any other copyrighted material (e.g., a book). The manual and the compiler may not be copied, partially or as a whole without the written consent from the mikroElektronika. The PDF-edition of the manual can be printed for private or local use, but not for distribution. Modifying the manual or the compiler is strictly prohibited.

HIGH RISK ACTIVITIES:

The *mikroPascal for 8051* compiler is not fault-tolerant and is not designed, manufactured or intended for use or resale as on-line control equipment in hazardous environments requiring fail-safe performance, such as in the operation of nuclear facilities, aircraft navigation or communication systems, air traffic control, direct life support machines, or weapons systems, in which the failure of the Software could lead directly to death, personal injury, or severe physical or environmental damage ("High Risk Activities"). mikroElektronika and its suppliers specifically disclaim any express or implied warranty of fitness for High Risk Activities.

LICENSE AGREEMENT:

By using the *mikroPascal for 8051* compiler, you agree to the terms of this agreement. Only one person may use licensed version of *mikroPascal for 8051* compiler at a time. Copyright © mikroElektronika 2003 - 2009.

This manual covers *mikroPascal for 8051* version 1.1 and the related topics. Newer versions may contain changes without prior notice.

COMPILER BUG REPORTS:

The compiler has been carefully tested and debugged. It is, however, not possible to guarantee a 100 % error free product. If you would like to report a bug, please contact us at the address office@mikroe.com. Please include next information in your bug report:

- Your operating system
- Version of *mikroPascal for 8051*
- Code sample
- Description of a bug

CONTACT US:

mikroElektronika
Voice: + 381 (11) 36 28 830
Fax: + 381 (11) 36 28 831
Web: www.mikroe.com
E-mail: office@mikroe.com

Windows is a Registered trademark of Microsoft Corp. All other trade and/or services marks are the property of the respective owners.

Table of Contents

CHAPTER 1	Introduction
CHAPTER 2	<i>mikroPascal for 8051</i> Environment
CHAPTER 3	<i>mikroPascal for 8051</i> Specifics
CHAPTER 4	8051 Specifics
CHAPTER 5	<i>mikroPascal for 8051</i> Language Reference
CHAPTER 6	<i>mikroPascal for 8051</i> Libraries

CHAPTER 1

Features	2
Where to Start	3
mikroElektronika Associates License Statement and Limited Warranty	4
IMPORTANT - READ CAREFULLY	4
LIMITED WARRANTY	5
HIGH RISK ACTIVITIES	6
GENERAL PROVISIONS	6
Technical Support	7
How to Register	8
Who Gets the License Key	8
How to Get License Key	8
After Receiving the License Key	10

CHAPTER 2

IDE Overview	12
Main Menu Options	14
File Menu Options	15
Edit Menu Options	16
Find Text	17
Replace Text	18
Find In Files	18
Go To Line	19
Replace Text	19
Regular expressions	19
View Menu Options	20
Toolbars	21
File Toolbar	21
Edit Toolbar	21
Advanced Edit Toolbar	22
Find/Replace Toolbar	22
Project Toolbar	23
Build Toolbar	23
Debugger	24

Styles Toolbar	24
Tools Toolbar	25
Project Menu Options	26
Run Menu Options	28
Tools Menu Options	29
Help Menu Options	30
Keyboard Shortcuts	31
IDE Overview	33
Customizing IDE Layout	35
Docking Windows	35
Saving Layout	36
Auto Hide	37
Advanced Code Editor	38
Advanced Editor Features	38
Code Assistant	40
Code Folding	40
Parameter Assistant	41
Code Templates (Auto Complete)	41
Auto Correct	42
Spell Checker	42
Bookmarks	42
Goto Line	42
Uncomment/Comment	42
Code Explorer	43
Routine List	44
Project Manager	45
Project Settings Window	47
Library Manager	48
Error Window	50
Statistics	51
Memory Usage Windows	51
RAM Memory	51
Data Memory	51
XData Memory	52
iData Memory	52
bData Memory	53

PData Memory	53
Special Function Registers	54
General Purpose Registers	54
ROM Memory	55
ROM Memory Usage	55
Procedures Windows	56
Procedures Size Window	56
Procedures Locations Window	57
Integrated Tools	58
USART Terminal	58
ASCII Chart	59
EEPROM Editor	60
7 Segment Display Decoder	60
UDP Terminal	61
The <i>mikroPascal for 8051</i>	61
Graphic LCD Bitmap Editor	62
LCD Custom Character	63
Options	64
Code editor	64
Tools	64
Output settings	66
Regular Expressions	67
Introduction	67
Simple matches	67
Escape sequences	67
Character classes	68
Metacharacters	68
Metacharacters - Line separators	69
Metacharacters - Predefined classes	69
Example:	69
Metacharacters - Word boundaries	70
Metacharacters - Iterators	70
Metacharacters - Alternatives	71
Metacharacters - Subexpressions	72
Metacharacters - Backreferences	72
<i>mikroPascal for 8051</i> Command Line Options	73

Projects	74
New Project	74
New Project Wizard Steps	75
Open Project	78
Customizing Projects	79
Edit Project	79
Managing Project Group	79
Add/Remove Files from Project	79
Source Files	81
Managing Source Files	81
Creating new source file	81
Opening an existing file	81
Printing an open file	81
Saving file	82
Saving file under a different name	82
Closing file	82
Clean Project Folder	83
Clean Project Folder	83
Compilation	84
Output Files	84
Assembly View	84
Error Messages	85
Compiler Error Messages:	85
Linker Error Messages:	88
Hint Messages:	88
Software Simulator Overview	89
Watch Window	89
Stopwatch Window	91
RAM Window	92
Software Simulator Options	93
Creating New Library	94
Multiple Library Versions	94

CHAPTER 3

Pascal Standard Issues	102
Divergence from the Pascal Standard	102
Pascal Language Extensions	102
Predefined Globals and Constants	103
Math constants	103
Accessing Individual Bits	104
Accessing Individual Bits Of Variables	104
sbit type	104
bit type	105
Interrupts	106
Function Calls from Interrupt	106
Interrupt Priority Level	106
Linker Directives	107
Directive absolute	107
Directive org	108
Built-in Routines	109
Lo	110
Hi	110
Higher	110
Highest	111
Inc	111
Dec	111
Delay_us	112
Delay_ms	112
Vdelay_ms	112
Delay_Cyc	113
Clock_KHz	113
Clock_MHz	113
SetFuncCall	114
Uart_Init	114
Code Optimization	115
Constant folding	115
Constant propagation	115
Copy propagation	115

Value numbering	115
"Dead code" elimination	115
Stack allocation	115
Local vars optimization	115
Better code generation and local optimization	115
Types Efficiency	117

CHAPTER 4

Nested Calls Limitations	118
8051 Memory Organization	118
Program Memory (ROM)	118
Internal Data Memory	119
External Data Memory	120
SFR Memory	120
Memory Models	121
Small model	121
Compact model	121
Large model	122
code	124
data	124
idata	124
bdata	124
xdata	125
pdata	125

CHAPTER 5

Lexical Elements Overview	130
Whitespace	130
Whitespace in Strings	131
Comments	131
Nested comments	131
Tokens	132
Token Extraction Example	132
Literals	133

Integer Literals	133
Floating Point Literals	133
Character Literals	134
String Literals	134
Keywords	136
Identifiers	139
Case Sensitivity	139
Uniqueness and Scope	139
Identifier Examples	139
Punctuators	140
Brackets	140
Parentheses	140
Comma	140
Semicolon	141
Colon	141
Dot	141
Program Organization	142
Organization of Main Unit	142
Organization of Other Units	143
Scope and Visibility	145
Scope	145
Visibility	145
Units	146
Uses Clause	146
Main Unit	146
Other Units	147
Interface Section	147
Implementation Section	148
Variables	149
Variables and 8051	149
Constants	150
Labels	151
Functions and Procedures	152
Functions	152
Calling a function	152
Example	153

Procedures	153
Calling a procedure	154
Example	154
Function Pointers	154
Example:	154
Example:	155
Forward declaration	156
Types	157
Type Categories	157
Simple Types	158
Arrays	159
Array Declaration	159
Constant Arrays	159
Multi-dimensional Arrays	160
Strings	161
String Concatenating	162
Note	162
@ Operator	164
Records	165
Accessing Fields	166
Types Conversions	167
Implicit Conversion	167
Promotion	167
Clipping	168
Explicit Conversion	168
Conversions Examples	169
Operators	170
Operators Precedence and Associativity	170
Arithmetic Operators	171
Division by Zero	171
Unary Arithmetic Operators	171
Relational Operators	172
Relational Operators in Expressions	172
Bitwise Operators	173
Bitwise Operators Overview	173
Logical Operations on Bit Level	173

Bitwise operators and, or, and xor perform logical operation	173
Unsigned and Conversions	174
Signed and Conversions	174
Bitwise Shift Operators	175
Boolean Operators	175
Expressions	176
Statements	176
Assignment Statements	177
Compound Statements (Blocks)	177
Conditional Statements	178
If Statement	178
Nested if statements	178
Case statement	179
Use the case sta	179
Nested Case statement	180
Iteration Statements	181
For Statement	181
Endless Loop	181
While Statement	182
Repeat Statement	183
Jump Statements	184
Break and Continue Statements	184
Break Statement	184
Continue Statement	185
Exit Statement	185
Goto Statement	186
asm Statement	187
Directives	188
Compiler Directives	188
Directives \$DEFINE and \$UNDEFINE	188
Directives \$IFDEF..\$ELSE	189
Include Directive \$I	190
Predefined Flags	190
Linker Directives	191
Directive absolute	191
Directive org	192

CHAPTER 6

Hardware 8051-specific Libraries	194
Miscellaneous Libraries	194
Library Dependencies	195
CANSPI Library	197
External dependencies of CANSPI Library	197
Library Routines	198
CANSPISetOperationMode until this mode is set)	199
CANSPISetOperationMode(CANSPI_MODE_CONFIG, 0xFF);	199
CANSPISetOperationMode	199
CANSPIGetOperationMode	199
CANSPIInitialize	200
CANSPISetBaudRate	202
CANSPISetMask	203
CANSPISetFilter	204
CANSPIRead	205
CANSPIWrite	206
CANSPI Constants	207
CANSPI_OP_MODE	207
CANSPI_CONFIG_FLAGS	207
CANSPI_TX_MSG_FLAGS	208
CANSPI_RX_MSG_FLAGS	209
CANSPI_MASK	209
CANSPI_FILTER	209
Library Example	210
HW Connection	214
EEPROM Library	215
Library Routines	215
Eeprom_Read	215
Eeprom_Write	216
Eeprom_Write_Block	217
Library Example	218
Graphic LCD Library	219
External dependencies of Graphic LCD Library	219
Library Routines	220

Glcd_Init	221
Glcd_Set_Side	222
Glcd_Set_X	222
Glcd_Set_Page	223
Glcd_Read_Data	223
Glcd_Write_Data	224
Glcd_Fill	224
Glcd_Dot	225
Glcd_Line	225
Glcd_V_Line	226
Glcd_H_Line	226
Glcd_Rectangle	227
Glcd_Box	227
Glcd_Circle	228
Glcd_Set_Font	228
Glcd_Write_Char	229
Glcd_Write_Text	230
Glcd_Image	230
Library Example	231
HW Connection	233
Keypad Library	234
External dependencies of Keypad Library	234
Library Routines	234
Keypad_Init	235
Keypad_Key_Press	235
Keypad_Key_Click	235
Library Example	236
HW Connection	238
LCD Library	239
External dependencies of LCD Library	239
Library Routines	239
Lcd_Init	240
Lcd_Out	241
Lcd_Out_Cp	241
Lcd_Chr	242
Lcd_Chr_Cp	242

Lcd_Cmd	243
Available LCD Commands	243
Library Example	244
HW connection	246
LCD HW connecti	246
OneWire Library	247
External dependencies of OneWire Library	247
Library Routines	247
Ow_Reset	248
Ow_Read	248
Ow_Write	249
Library Example	249
This example reads the te	249
HW Connection	252
Manchester Code Library	253
External dependencies of Manchester Code Library	253
Library Routines	254
Man_Receive_Init	254
Man_Receive	255
Man_Send_Init	255
Man_Send	256
Man_Synchro	256
Man_Out	257
Library Example	257
Connection Example	260
Port Expander Library	261
External dependencies of Port Expander Library	261
Expander_Init	262
Expander_Read_Byte	263
Expander_Write_Byte	263
Expander_Read_PortA	264
Expander_Read_PortB	264
Expander_Read_PortAB	265
Expander_Write_PortA	265
Expander_Write_PortB	266
Expander_Write_PortAB	266

Expander_Set_DirectionPortA	267
Expander_Set_DirectionPortB	267
Expander_Set_DirectionPortAB	268
Expander_Set_PullUpsPortA	268
Expander_Set_PullUpsPortB	269
Expander_Set_PullUpsPortAB	269
Library Example	270
HW Connection	271
PS/2 Library	272
External dependencies of PS/2 Library	272
Library Routines	272
Ps2_Config	273
Ps2_Key_Read	274
Special Function Keys	275
Library Example	276
HW Connection	277
RS-485 Library	278
External dependencies of RS-485 Library	278
Library Routines	278
RS485master_Init	279
RS485master_Receive	279
RS485master_Send	280
RS485slave_Init	281
RS485slave_Receive	282
RS485slave_Send	283
Library Example	283
This is a simple demonstration o	283
HW Connection	287
Message format and CRC calculations	288
Software I ² C Library	289
External dependencies of Soft_I2C Library	289
Library Routines	289
Soft_I2C_Init	290
Soft_I2C_Start	290
Soft_I2C_Read	290
Soft_I2C_Write	291

Soft_I2C_Stop	291
Library Example	292
Software SPI Library	295
External dependencies of Software SPI Library	295
Library Routines	295
Soft_Spi_Init	296
Soft_Spi_Read	296
Soft_Spi_Write	297
Library Example	297
This code demonstrates using lib	297
Software UART Library	299
External dependencies of Software UART Library	299
Library Routines	299
Soft_Uart_Init	300
Soft_Uart_Read	301
Soft_Uart_Write	302
Library Example	303
var Sound_Play_Pin: sbit at P0.B3;	304
Sound Library	304
External dependencies of Sound Library	304
Library Routines	304
Sound_Init	304
Sound_Play	305
Library Example	305
The example is a simple dem	305
HW Connection	308
SPI Library	309
Library Routines	309
Spi_Init	309
Spi_Init_Advanced	310
Spi_Read	311
Spi_Write	311
Library Example	312
HW Connection	313
SPI Ethernet Library	314
Library Routines	315

Spi_Ethernet_Init	316
Spi_Ethernet_Enable	318
Spi_Ethernet_Disable	319
Spi_Ethernet_doPacket	320
Spi_Ethernet_putByte	321
Spi_Ethernet_putBytes	321
Spi_Ethernet_putConstBytes	322
Spi_Ethernet_putString	322
Spi_Ethernet_putConstString	323
Spi_Ethernet_getByte	323
Spi_Ethernet_getBytes	324
Spi_Ethernet_UserTCP	325
Spi_Ethernet_UserUDP	326
Library Example	326
HW Connection	334
SPI Graphic LCD Library	335
External dependencies of SPI Graphic LCD Library	335
Library Routines	335
Spi_Glcd_Init	336
Spi_Glcd_Set_Side	336
Spi_Glcd_Set_Page	337
Spi_Glcd_Set_X	337
Spi_Glcd_Read_Data	338
Spi_Glcd_Write_Data	338
Spi_Glcd_Fill	339
Spi_Glcd_Dot	339
Spi_Glcd_Line	340
Spi_Glcd_V_Line	340
Spi_Glcd_H_Line	341
Spi_Glcd_Rectangle	341
Spi_Glcd_Box	342
Spi_Glcd_Circle	342
Spi_Glcd_Set_Font	343
Spi_Glcd_Write_Char	344
Spi_Glcd_Write_Text	345
Spi_Glcd_Image	346

Library Example	346
The example demonstrates how to	346
HW Connection	348
SPI LCD Library	349
External dependencies of SPI LCD Library	349
Library Routines	349
Spi_Lcd_Config	350
Spi_Lcd_Out	350
Spi_Lcd_Out_Cp	351
Spi_Lcd_Chr	351
Spi_Lcd_Chr_Cp	352
Spi_Lcd_Cmd	352
Available LCD Commands	353
Library Example	354
HW Connection	355
SPI LCD8 (8-bit interface) Library	356
External dependencies of SPI LCD Library	356
Library Routines	356
Spi_Lcd8_Config	357
Spi_Lcd8_Out	357
Spi_Lcd8_Out_Cp	358
Spi_Lcd8_Chr	358
Spi_Lcd8_Chr_Cp	359
Spi_Lcd8_Cmd	359
Available LCD Commands	360
Library Example	361
HW Connection	362
SPI T6963C Graphic LCD Library	363
External dependencies of Spi T6963C Graphic LCD Library	363
Library Routines	364
Spi_T6963C_Config	365
Spi_T6963C_WriteData	366
Spi_T6963C_WriteCommand	366
Spi_T6963C_SetPtr	367
Spi_T6963C_WaitReady	367
Spi_T6963C_Fill	367

Spi_T6963C_Dot	368
Spi_T6963C_Write_Char	369
Spi_T6963C_Write_Text	370
Spi_T6963C_Line	371
Spi_T6963C_Rectangle	371
Spi_T6963C_Box	372
Spi_T6963C_Circle	372
Spi_T6963C_Image	373
Spi_T6963C_Sprite	373
Spi_T6963C_Set_Cursor	374
Spi_T6963C_ClearBit	374
Spi_T6963C_SetBit	374
Spi_T6963C_NegBit	375
Spi_T6963C_DisplayGrPanel	375
Spi_T6963C_DisplayTxtPanel	375
Spi_T6963C_SetGrPanel	376
Spi_T6963C_SetTxtPanel	376
Spi_T6963C_PanelFill	377
Spi_T6963C_GrFill	377
Spi_T6963C_TxtFill	377
Spi_T6963C_Cursor_Height	378
Spi_T6963C_Graphics	378
Spi_T6963C_Text	378
Spi_T6963C_Cursor	379
Spi_T6963C_Cursor_Blink	379
Library Example	379
The following drawing demo tests advanced	379
HW Connection	384
T6963C Graphic LCD Library	385
External dependencies of T6963C Graphic LCD Library	385
Library Routines	386
T6963C_Init	387
T6963C_WriteData	388
T6963C_WriteCommand	388
T6963C_SetPtr	389
T6963C_WaitReady	389

T6963C_Fill	389
T6963C_Dot	390
T6963C_Write_Char	391
T6963C_Write_Text	392
T6963C_Line	393
T6963C_Rectangle	393
T6963C_Box	394
T6963C_Circle	394
T6963C_Image	395
T6963C_Sprite	395
T6963C_Set_Cursor	396
T6963C_ClearBit	396
T6963C_SetBit	396
T6963C_NegBit	397
T6963C_DisplayGrPanel	397
T6963C_DisplayTxtPanel	397
T6963C_SetGrPanel	398
T6963C_SetTxtPanel	398
T6963C_PanelFill	399
T6963C_GrFill	399
T6963C_TxtFill	399
T6963C_Cursor_Height	400
T6963C_Graphics	400
T6963C_Text	400
T6963C_Cursor	401
T6963C_Cursor_Blink	401
Library Example	401
The following drawing demo tests a	401
vanced routines	401
HW Connection	406
UART Library	407
Library Routines	407
Uart_Init	407
Uart_Data_Ready	408
Uart_Read	408
Uart_Write	409

Library Example	409
This example demonstrates	409
HW Connection	410
Button Library	411
External dependencies of Button Library	411
Library Routines	411
Button	412
Conversions Library	413
Library Routines	413
ByteToStr	414
ShortToStr	414
WordToStr	415
IntToStr	415
LongintToStr	416
LongWordToStr	416
FloatToStr	417
Dec2Bcd	418
Bcd2Dec16	418
Dec2Bcd16	419
Math Library	420
Library Functions	420
acos	421
asin	421
atan	421
atan2	421
ceil	421
cos	421
cosh	421
eval_poly	422
exp	422
fabs	422
floor	422
frexp	422
ldexp	422
log	422
log10	423

modf	423
pow	423
sin	423
sinh	423
sqrt	423
tan	423
tanh	423
String Library	424
Library Functions	424
memchr	425
memcmp	425
memcpy	426
memmove	426
memset	426
strcat	426
strchr	427
strcmp	427
strcpy	427
strcspn	427
strlen	428
strncat	428
strncmp	428
strncpy	428
strpbrk	428
strrchr	429
strspn	429
strstr	429
Time Library	430
Library Routines	430
Time_dateToEpoch	430
Time_epochToDate	431
Time_dateDiff	431
Library Example	432
TimeStruct type definition	433
Trigonometry Library	434
Library Routines	434

sinE3	434
cosE3	435

CHAPTER

1

Introduction to *mikroPascal for 8051*

The *mikroPascal for 8051* is a powerful, feature-rich development tool for 8051 microcontrollers. It is designed to provide the programmer with the easiest possible solution to developing applications for embedded systems, without compromising performance or control.

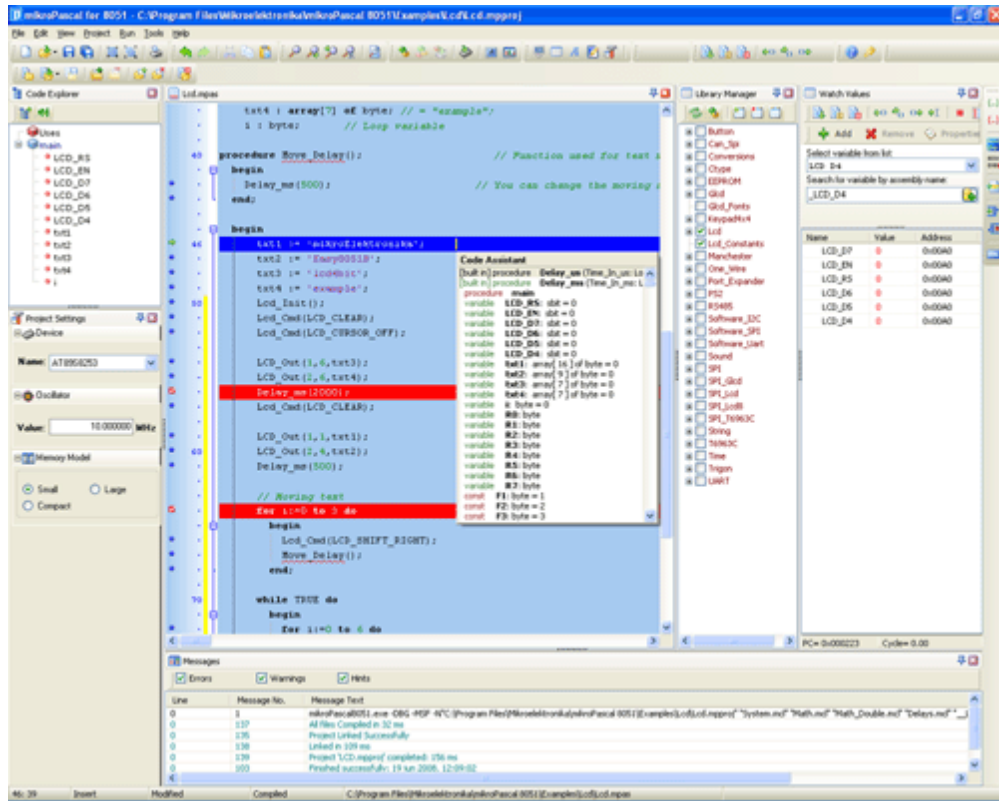

mikroPascal IDE

Features

mikroPascal for 8051 allows you to quickly develop and deploy complex applications:

- Write your Pascal source code using the built-in Code Editor (Code and Parameter Assistants, Code Folding, Syntax Highlighting, Spell Checker, Auto Correct, Code Templates, and more.)
- Use included mikroPascal libraries to dramatically speed up the development: data acquisition, memory, displays, conversions, communication etc.
- Monitor your program structure, variables, and functions in the Code Explorer.
- Generate commented, human-readable assembly, and standard HEX compatible with all programmers.
- Inspect program flow and debug executable logic with the integrated Software Simulator.
- Get detailed reports and graphs: RAM and ROM map, code statistics, assembly listing, calling tree, and more.

- mikroPascal 8051 provides plenty of examples to expand, develop, and use as building bricks in your projects. Copy them entirely if you deem fit – that's why we included them with the compiler.

Where to Start

- In case that you're a beginner in programming 8051 microcontrollers, read carefully the 8051 Specifics chapter. It might give you some useful pointers on 8051 constraints, code portability, and good programming practices.
- If you are experienced in Pascal programming, you will probably want to consult mikroPascal Specifics first. For language issues, you can always refer to the comprehensive Language Reference. A complete list of included libraries is available at mikroPascal Libraries.
- If you are not very experienced in Pascal programming, don't panic! mikroPascal 8051 provides plenty of examples making it easy for you to go quickly. We suggest that you first consult Projects and Source Files, and then start browsing the examples that you're the most interested in.

MIKROELEKTRONIKA ASSOCIATES LICENSE STATEMENT AND LIMITED WARRANTY

IMPORTANT - READ CAREFULLY

This license statement and limited warranty constitute a legal agreement (“License Agreement”) between you (either as an individual or a single entity) and mikroElektronika (“mikroElektronika Associates”) for software product (“Software”) identified above, including any software, media, and accompanying on-line or printed documentation.

BY INSTALLING, COPYING, OR OTHERWISE USING SOFTWARE, YOU AGREE TO BE BOUND BY ALL TERMS AND CONDITIONS OF THE LICENSE AGREEMENT.

Upon your acceptance of the terms and conditions of the License Agreement, mikroElektronika Associates grants you the right to use Software in a way provided below.

This Software is owned by mikroElektronika Associates and is protected by copyright law and international copyright treaty. Therefore, you must treat this Software like any other copyright material (e.g., a book).

You may transfer Software and documentation on a permanent basis provided. You retain no copies and the recipient agrees to the terms of the License Agreement. Except as provided in the License Agreement, you may not transfer, rent, lease, lend, copy, modify, translate, sublicense, time-share or electronically transmit or receive Software, media or documentation. You acknowledge that Software in the source code form remains a confidential trade secret of mikroElektronika Associates and therefore you agree not to modify Software or attempt to reverse engineer, decompile, or disassemble it, except and only to the extent that such activity is expressly permitted by applicable law notwithstanding this limitation.

If you have purchased an upgrade version of Software, it constitutes a single product with the mikroElektronika Associates software that you upgraded. You may use the upgrade version of Software only in accordance with the License Agreement.

LIMITED WARRANTY

Respectfully excepting the Redistributables, which are provided “as is”, without warranty of any kind, mikroElektronika Associates warrants that Software, once updated and properly used, will perform substantially in accordance with the accompanying documentation, and Software media will be free from defects in materials and workmanship, for a period of ninety (90) days from the date of receipt. Any implied warranties on Software are limited to ninety (90) days.

mikroElektronika Associates' and its suppliers' entire liability and your exclusive remedy shall be, at mikroElektronika Associates' option, either (a) return of the price paid, or (b) repair or replacement of Software that does not meet mikroElektronika Associates' Limited Warranty and which is returned to mikroElektronika Associates with a copy of your receipt. DO NOT RETURN ANY PRODUCT UNTIL YOU HAVE CALLED MIKROELEKTRONIKA ASSOCIATES FIRST AND OBTAINED A RETURN AUTHORIZATION NUMBER. This Limited Warranty is void if failure of Software has resulted from an accident, abuse, or misapplication. Any replacement of Software will be warranted for the rest of the original warranty period or thirty (30) days, whichever is longer.

TO THE MAXIMUM EXTENT PERMITTED BY APPLICABLE LAW, MIKROELEKTRONIKA ASSOCIATES AND ITS SUPPLIERS DISCLAIM ALL OTHER WARRANTIES AND CONDITIONS, EITHER EXPRESSED OR IMPLIED, INCLUDED, BUT NOT LIMITED TO IMPLIED WARRANTIES OF MERCHANTABILITY, FITNESS FOR A PARTICULAR PURPOSE, TITLE, AND NON-INFRINGEMENT, WITH REGARD TO SOFTWARE, AND THE PROVISION OF OR FAILURE TO PROVIDE SUPPORT SERVICES.

IN NO EVENT SHALL MIKROELEKTRONIKA ASSOCIATES OR ITS SUPPLIERS BE LIABLE FOR ANY SPECIAL, INCIDENTAL, INDIRECT, OR CONSEQUENTIAL DAMAGES WHATSOEVER (INCLUDING, WITHOUT LIMITATION, DAMAGES FOR LOSS OF BUSINESS PROFITS AND BUSINESS INFORMATION, BUSINESS INTERRUPTION, OR ANY OTHER PECUNIARY LOSS) ARISING OUT OF THE USE OF OR INABILITY TO USE SOFTWARE PRODUCT OR THE PROVISION OF OR FAILURE TO PROVIDE SUPPORT SERVICES, EVEN IF MIKROELEKTRONIKA ASSOCIATES HAS BEEN ADVISED OF THE POSSIBILITY OF SUCH DAMAGES. IN ANY CASE, MIKROELEKTRONIKA ASSOCIATES' ENTIRE LIABILITY UNDER ANY PROVISION OF THIS LICENSE AGREEMENT SHALL BE LIMITED TO THE AMOUNT ACTUALLY PAID BY YOU FOR SOFTWARE PRODUCT PROVIDED, HOWEVER, IF YOU HAVE ENTERED INTO A MIKROELEKTRONIKA ASSOCIATES SUPPORT SERVICES AGREEMENT, MIKROELEKTRONIKA ASSOCIATES' ENTIRE LIABILITY REGARDING SUPPORT SERVICES SHALL BE GOVERNED BY THE TERMS OF THAT AGREEMENT.

HIGH RISK ACTIVITIES

Software is not fault-tolerant and is not designed, manufactured or intended for use or resale as on-line control equipment in hazardous environments requiring fail-safe performance, such as in the operation of nuclear facilities, aircraft navigation or communication systems, air traffic control, direct life support machines, or weapons systems, in which the failure of Software could lead directly to death, personal injury, or severe physical or environmental damage (“High Risk Activities”). mikroElektronika Associates and its suppliers specifically disclaim any expressed or implied warranty of fitness for High Risk Activities.

GENERAL PROVISIONS

This statement may only be modified in writing signed by you and an authorised officer of mikroElektronika Associates. If any provision of this statement is found void or unenforceable, the remainder will remain valid and enforceable according to its terms. If any remedy provided is determined to have failed for its essential purpose, all limitations of liability and exclusions of damages set forth in the Limited Warranty shall remain in effect.

This statement gives you specific legal rights; you may have others, which vary, from country to country. mikroElektronika Associates reserves all rights not specifically granted in this statement.

mikroElektronika

Visegradaska 1A,
11000 Belgrade,
Europe.

Phone: + 381 11 36 28 830

Fax: +381 11 36 28 831

Web: www.mikroe.com

E-mail: office@mikroe.com

TECHNICAL SUPPORT

In case you encounter any problem, you are welcome to our support forums at www.mikroe.com/forum/. Here, you may also find helpful information, hardware tips, and practical code snippets. Your comments and suggestions on future development of the *mikroPascal for 8051* are always appreciated — feel free to drop a note or two on our Wishlist.

In our Knowledge Base www.mikroe.com/en/kb/ you can find the answers to Frequently Asked Questions and solutions to known problems. If you can not find the solution to your problem in Knowledge Base then report it to Support Desk www.mikroe.com/en/support/. In this way, we can record and track down bugs more efficiently, which is in our mutual interest. We respond to every bug report and question in a suitable manner, ever improving our technical support.

HOW TO REGISTER

The latest version of the *mikroPascal for 8051* is always available for downloading from our website. It is a fully functional software libraries, examples, and comprehensive help included.

The only limitation of the free version is that it cannot generate hex output over 2 KB. Although it might sound restrictive, this margin allows you to develop practical, working applications with no thinking of demo limit. If you intend to develop really complex projects in the *mikroPascal for 8051*, then you should consider the possibility of purchasing the license key.

Before we start you might find this link very useful, regarding the questions related to registration procedure. Copy and paste this link into your web browser

http://www.mikroe.com/pdf/mikrobasic/compiler_activation.pdf (this file is in PDF format).

Who Gets the License Key

Buyers of the *mikroPascal for 8051* are entitled to the license key. After you have completed the payment procedure, you have an option of registering your mikroPascal. In this way you can generate hex output without any limitations.

How to Get License Key

After you have completed the payment procedure, start the program. Select **Help** › **How to Register** from the drop-down menu or click the How To Register Icon . Fill out the registration form (figure below), select your distributor, and click the Send button.

How To Register

Step 1. Fill in the form below. Please, make sure you fill in all required fields.
Step 2. Make sure that you provided a **valid email address** in the "EMAIL" edit box. This email will be used for sending you the activation key.
Step 3. Make sure you select a correct distributor which will make the registration process faster. If your distributor is not on the list then select "Other" and type in distributor's email address in the box below.
Step 4. Press the **SEND** button to send key request. A default email client will open with ready-to-send message.
 Note: If email client does not open, you may copy text of the message and paste it manually into a new email message before sending it to your distributor's email.

NAME*	Marko Medic
ADDRESS	Enter your address
INVOICE	Enter invoice number if available
E-MAIL*	marko.medic@mikroe.com
E-MAIL*	marko.medic@mikroe.com
COMPANY	Enter company name
PRODUCT ID	455A-677169-766564-674C10
DISTRIBUTOR*	mikroElektronika key@mikroe.com

*** Required fields**

I have made the payment and I wish to request activation key for mikroPascal for 8051-----

Name:
Marko Medic

Address:

Invoice number:

Company:

E-Mail:
marko.medic@mikroe.com

Product key:
455A-677169-766564-674C10

Distributor:
mikroElektronika
key@mikroe.com

Copy to clipboard SEND Cancel

This will start your e-mail client with message ready for sending. Review the information you have entered, and add the comment if you deem it necessary. Please, do not modify the subject line.

Upon receiving and verifying your request, we will send the license key to the e-mail address you specified in the form.

After Receiving the License Key

The license key comes as a small autoextracting file – just start it anywhere on your computer in order to activate your copy of compiler and remove the demo limit. You do not need to restart your computer or install any additional components. Also, there is no need to run the *mikroPascal for 8051* at the time of activation.

Notes:

- The license key is valid until you format your hard disk. In case you need to format the hard disk, you should request a new activation key.
- **Please keep the activation program in a safe place. Every time you upgrade the compiler you should start this program again in order to reactivate the license.**

CHAPTER

2

mikroPascal for 8051 Environment

The *mikroPascal for 8051* is an user-friendly and intuitive environment:

IDE Overview

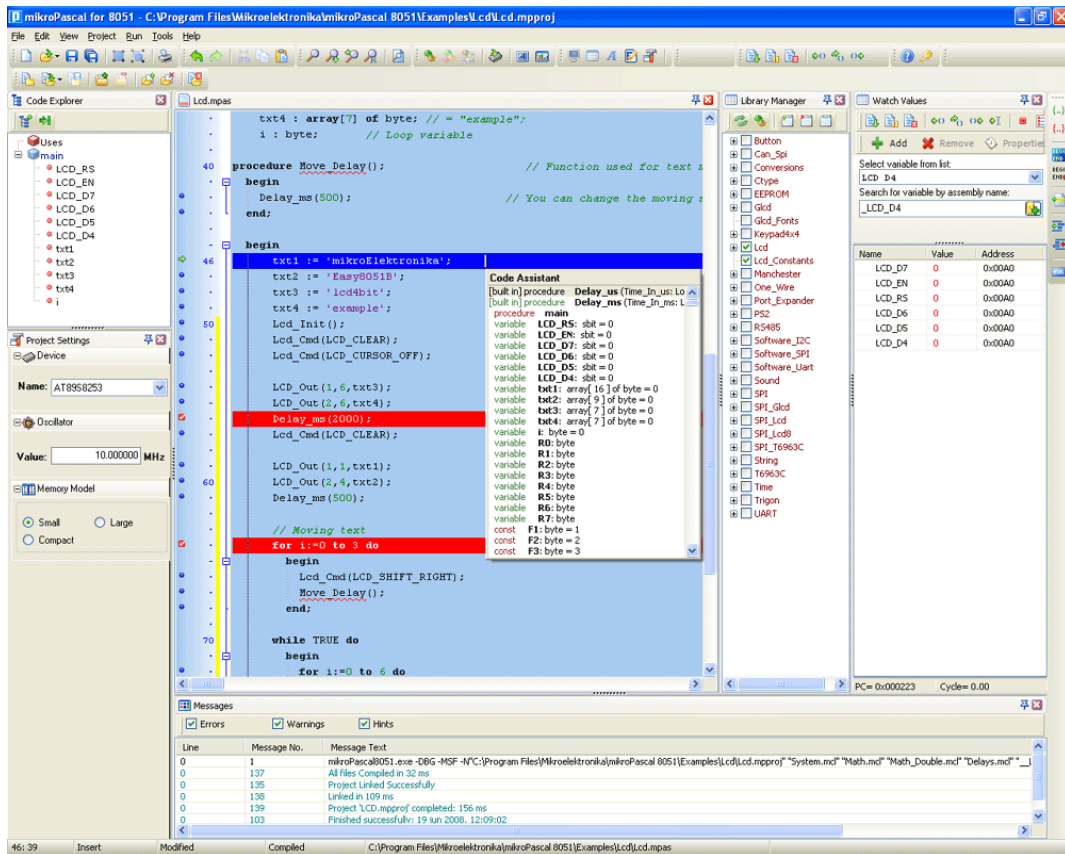

- The Code Editor features adjustable Syntax Highlighting, Code Folding, Code Assistant, Parameters Assistant, Spell Checker, Auto Correct for common typos and Code Templates (Auto Complete).
- The Code Explorer (with Keyboard shortcut browser and Quick Help browser) is at your disposal for easier project management.
- The Project Manager allows multiple project management
- General project settings can be made in the Project Settings window
- Library manager enables simple handling libraries being used in a project
- The Error Window displays all errors detected during compiling and linking.
- The source-level Software Simulator lets you debug executable logic step-by-step by watching the program flow.
- The New Project Wizard is a fast, reliable, and easy way to create a project.
- Help files are syntax and context sensitive.
- Like in any modern Windows application, you may customize the layout of *mikroPascal for 8051* to suit your needs best.

- Spell checker underlines identifiers which are unknown to the project. In this way it helps the programmer to spot potential problems early, much before the project is compiled.
Spell checker can be disabled by choosing the option in the Preferences dialog (F12).

MAIN MENU OPTIONS

Available Main Menu options are:

File

Edit

View

Project

Run

Tools





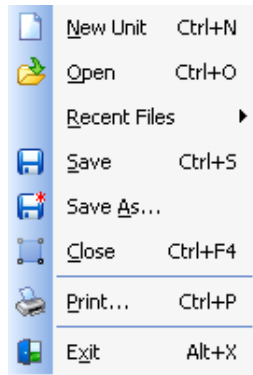

Help

Related topics: Keyboard shortcuts

FILE MENU OPTIONS

The File menu is the main entry point for manipulation with the source files.







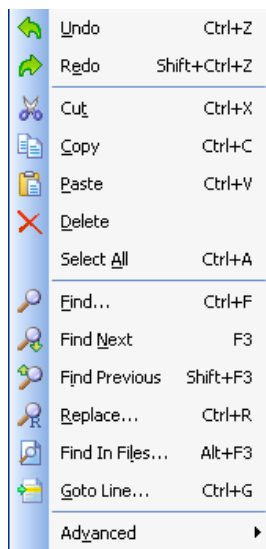

File	Description
 New Unit Ctrl+N	Open a new editor window.
 Open Ctrl+O	Open source file for editing or image file for viewing.
Recent Files ▶	Reopen recently used file.
 Save Ctrl+S	Save changes for active editor.
 Save As...	Save the active source file with the different name or change the file type.
 Close Alt+F4	Close active source file.
 Print... Ctrl+P	Print Preview.
 Exit Alt+X	Exit IDE.

Related topics: Keyboard shortcuts, File Toolbar, Managing Source Files

EDIT MENU OPTIONS



Edit	Description
Undo Ctrl+Z	Undo last change.
Redo Shift+Ctrl+Z	Redo last change.
Cut Ctrl+X	Cut selected text to clipboard.
Copy Ctrl+C	Copy selected text to clipboard.
Paste Ctrl+V	Paste text from clipboard.
Delete	Delete selected text.
Select All Ctrl+A	Select all text in active editor.
Find... Ctrl+F	Find text in active editor.
Find Next F3	Find next occurrence of text in active editor.
Find Previous Shift+F3	Find previous occurrence of text in active editor.
Replace... Ctrl+R	Replace text in active editor.
Find In Files... Alt+F3	Find text in current file, in all opened files, or in files from desired folder.
Goto Line... Ctrl+G	Goto to the desired line in active editor.
Advanced ▶	Advanced Code Editor options

Advanced »	Description
 <u>C</u> omment Shift+Ctrl+.	Comment selected code or put single line comment if there is no selection.
 <u>U</u> ncomment Shift+Ctrl+.,	Uncomment selected code or remove single line comment if there is no selection.
 <u>I</u> ndent Shift+Ctrl+I	Indent selected code.
 <u>O</u> utdent Shift+Ctrl+U	Outdent selected code.
 <u>L</u> owercase Ctrl+Alt+L	Changes selected text case to lowercase.
 <u>U</u> ppercase Ctrl+Alt+U	Changes selected text case to uppercase.
 <u>T</u> itlecase Ctrl+Alt+T	Changes selected text case to titlecase.

Find Text

Dialog box for searching the document for the specified text. The search is performed in the direction specified. If the string is not found a message is displayed.

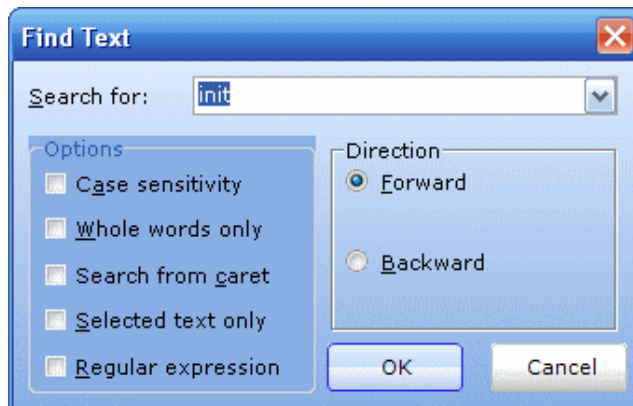

Replace Text

Dialog box for searching for a text string in file and replacing it with another text string.

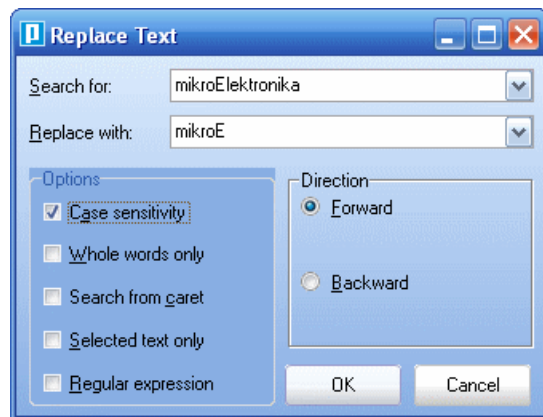

Find In Files

Dialog box for searching for a text string in current file, all opened files, or in files on a disk.

The string to search for is specified in the **Text to find** field. If Search in directories option is selected, The files to search are specified in the **Files mask** and **Path** fields.

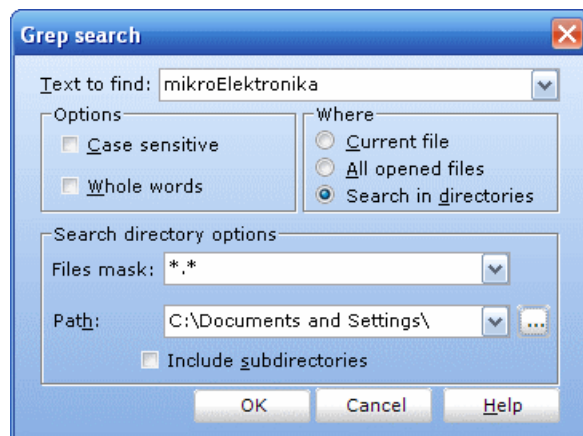

Go To Line

Dialog box that allows the user to specify the line number at which the cursor should be positioned.

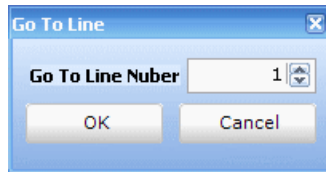

Replace Text

Dialog box for searching for a text string in file and replacing it with another text string.

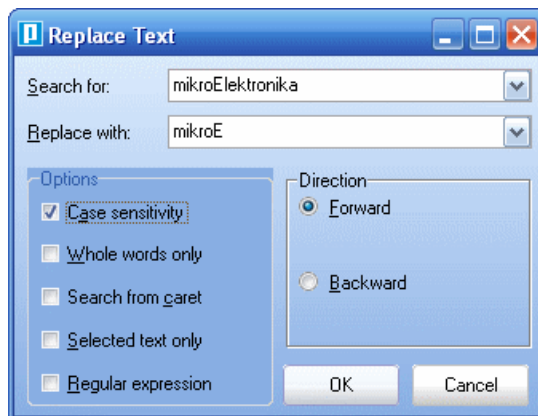

Regular expressions

By checking this box, you will be able to advance your search, through Regular expressions.

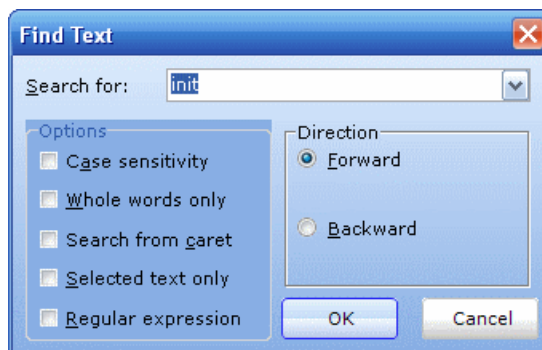

Related topics: Keyboard shortcuts, Edit Toolbar, Advanced Edit Toolbar

VIEW MENU OPTIONS

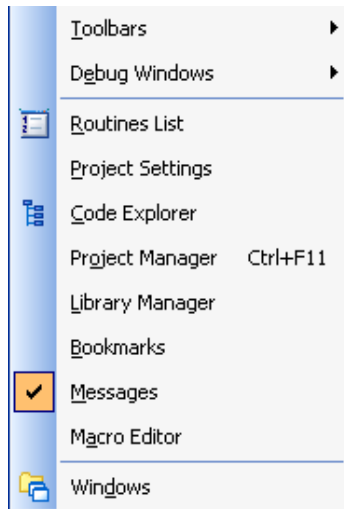







File	Description
Toolbars	Show/Hide toolbars.
Debug Windows	Show/Hide debug windows.
Routines List	Show/Hide Routine List in active editor.
Project Settings	Show/Hide Project Settings window.
Code Explorer	Show/Hide Code Explorer window.
Project Manager Shift+Ctrl+F11	Show/Hide Project Manager window.
Library Manager	Show/Hide Library Manager window.
Bookmarks	Show/Hide Bookmarks window.
Messages	Show/Hide Error Messages window.
Macro Editor	Show/Hide Macro Editor window.
Windows	Show Window List window.

TOOLBARS

File Toolbar







File Toolbar is a standard toolbar with following options:

Icon	Description
	Opens a new editor window.
	Open source file for editing or image file for viewing.
	Save changes for active window.
	Save changes in all opened windows.
	Close current editor.
	Close all editors.
	Print Preview.

Edit Toolbar











Edit Toolbar is a standard toolbar with following options:

Icon	Description
	Undo last change.
	Redo last change.
	Cut selected text to clipboard.
	Copy selected text to clipboard.
	Paste text from clipboard.

Advanced Edit Toolbar







Advanced Edit Toolbar comes with following options:

Icon	Description
	Comment selected code or put single line comment if there is no selection
	Uncomment selected code or remove single line comment if there is no selection.
	Select text from starting delimiter to ending delimiter.
	Go to ending delimiter.
	Go to line.
	Indent selected code lines.
	Outdent selected code lines.
	Generate HTML code suitable for publishing current source code on the web.

Find/Replace Toolbar











Find/Replace Toolbar is a standard toolbar with following options:

Icon	Description
	Find text in current editor.
	Find next occurrence.
	Find previous occurrence.
	Replace text.
	Find text in files.

Project Toolbar









Project Toolbar comes with following options:

Icon	Description
	Open new project wizard. wizard.
	Open Project
	Save Project
	Add existing project to project group.
	Remove existing project from project group.
	Add File To Project
	Remove File From Project
	Close current project.

Build Toolbar



Build Toolbar comes with following options:

Icon	Description
	Build current project.
	Build all opened projects.
	Build and program active project.
	Start programmer and load current HEX file.
	Open assembly code in editor.
	View statistics for current project.

Debugger



Debugger Toolbar comes with following options:

Icon	Description
	Start Software Simulator.
	Run/Pause debugger.
	Stop debugger.
	Step into.
	Step over.
	Step out.
	Run to cursor.
	Toggle breakpoint.
	Toggle breakpoints.
	Clear breakpoints.
	View watch window
	View stopwatch window

Styles Toolbar

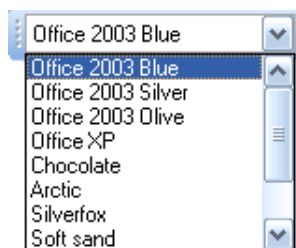





Styles toolbar allows you to easily customize your workspace.

Tools Toolbar



Tools Toolbar comes with following default options:









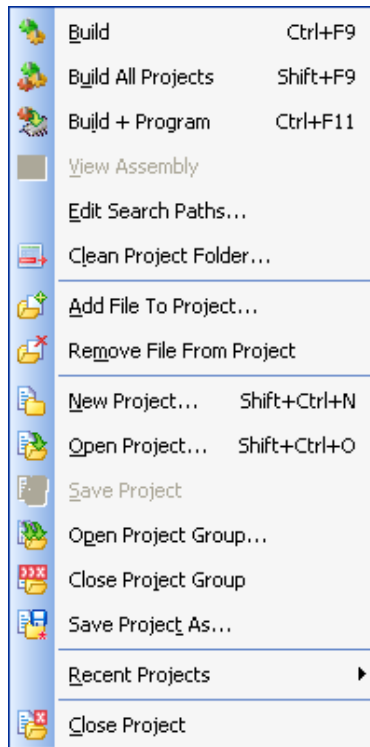





Icon	Description
	Run USART Terminal
	EEPROM
	ASCII Chart
	Seven segment decoder tool.

The Tools toolbar can easily be customized by adding new tools in Options(F12) window.

Related topics: Keyboard shortcuts, Integrated Tools, Debugger Windows













PROJECT MENU OPTIONS















Project	Description
 Build Ctrl+F9	Build active project.
 Build All Shift+F9	Build all projects.
 Build + Program Ctrl+F11	Build and program active project.
 View Assembly	View Assembly.
Edit Search Paths...	Edit search paths.
 Clean Project Folder ...	Clean Project Folder
 Add File To Project...	Add file to project.
 Remove File From Project	Remove file from project.
 New Project...	Open New Project Wizard
 Open Project... Shift+Ctrl+O	Open existing project.
 Save Project	Save current project.
 Open Project Group...	Open project group.
 Close Project Group	Close project group.
 Save Project As...	Save active project file with the different name.
Recent Projects ▶	Open recently used project.
 Close Project	Close active project.

Related topics: Keyboard shortcuts, Project Toolbar, Creating New Project, Project Manager, Project Settings

RUN MENU OPTIONS









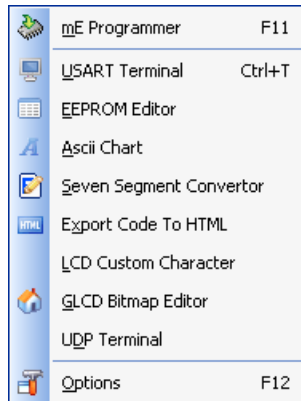

	Start Debugger	F9
	Stop Debugger	Ctrl+F2
	Pause Debugger	F6
	Step Into	F7
	Step Over	F8
	Step Out	Ctrl+F8
	Jump To Interrupt	F2
	Toggle Breakpoint	F5
	Breakpoints	Shift+F4
	Clear Breakpoints	Shift+Ctrl+F5
	Watch Window	Shift+F5
	View Stopwatch	
	Disassembly mode	Alt+D

Run	Description
 Start Debugger F9	Start Software Simulator.
 Stop Debugger Ctrl+F2	Stop debugger.
 Pause Debugger F6	Pause Debugger.
 Step Into F7	Step Into.
 Step Over F8	Step Over.
 Step Out Ctrl+F8	Step Out.
 Jump To Interrupt F2	Jump to interrupt in current project.
 Toggle Breakpoint F5	Toggle Breakpoint.
 Show/Hide Breakpoints Shift+F4	Breakpoints.
 Clear Breakpoints Shift+Ctrl+F5	Clear Breakpoints.
 Watch Window Shift+F5	Show/Hide Watch Window
 View Stopwatch	Show/Hide Stopwatch Window
Disassembly mode Ctrl+D	Toggle between Pascal source and disassembly.

Related topics: Keyboard shortcuts, Debug Toolbar

TOOLS MENU OPTIONS





Tools	Description
 PicFlash Programmer F11	Run mikroElektronika Programmer
 USART Terminal Ctrl+T	Run USART Terminal
 EEPROM Editor	Run EEPROM Editor
 Ascii Chart	Run ASCII Chart
 Seven Segment Convertor	Run 7 Segment Display Decoder
 Export Code To HTML	Generate HTML code suitable for publishing source code on the web.
 LCD Custom Character	Generate your own custom LCD characters
 GLCD Bitmap Editor	Generate bitmap pictures for GLCD
 UDP Terminal	UDP communication terminal.
 Options F12	Open Options window

Related topics: Keyboard shortcuts, Tools Toolbar

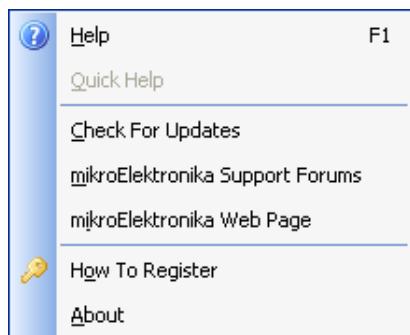
HELP MENU OPTIONS



Help	Description
 <u>H</u> elp F1	Open Help File.
<u>Q</u> uick Help	Quick Help.
<u>C</u> heck For Updates	Check if new compiler version is available.
<u>m</u> ikroElektronika Support Forums	Open mikroElektronika Support Forums in a default browser.
<u>m</u> ikroElektronika Web Page	Open mikroElektronika Web Page in a default browser.
 <u>H</u> ow To Register	Information on how to register
<u>A</u> bout	Open About window.

Related topics: Keyboard shortcuts

KEYBOARD SHORTCUTS

Below is a complete list of keyboard shortcuts available in *mikroPascal for 8051* IDE. You can also view keyboard shortcuts in the Code Explorer window, tab Keyboard.

IDE Shortcuts		Ctrl+X	Cut
F1	Help	Ctrl+Y	Delete entire line
Ctrl+N	New Unit	Ctrl+Z	Undo
Ctrl+O	Open	Ctrl+Shift+Z	Redo
Ctrl+Shift+O	Open Project	Advanced Editor Shortcuts	
Ctrl+Shift+N	Open New Project	Ctrl+Space	Code Assistant
Ctrl+K	Close Project	Ctrl+Shift+Space	Parameters Assistant
Ctrl+F9	Compile	Ctrl+D	Find declaration
Shift+F9	Compile All	Ctrl+E	Incremental Search
Ctrl+F11	Compile and Program	Ctrl+L	Routine List
Shift+F4	View breakpoints	Ctrl+G	Goto line
Ctrl+Shift+F5	Clear breakpoints	Ctrl+J	Insert Code Template
F11	Start 8051Flash Programmer	Ctrl+Shift+.	Comment Code
F12	Preferences	Ctrl+Shift+,	Uncomment Code
Basic Editor Shortcuts		Ctrl+number	Goto bookmark
F3	Find, Find Next	Ctrl+Shift+number	Set bookmark
Shift+F3	Find Previous	Ctrl+Shift+I	Indent selection
Alt+F3	Grep Search, Find in Files	Ctrl+Shift+U	Unindent selection
Ctrl+A	Select All	TAB	Indent selection
Ctrl+C	Copy	Shift+TAB	Unindent selection
Ctrl+F	Find	Alt+Select	Select columns
Ctrl+R	Replace	Ctrl+Alt+Select	Select columns
Ctrl+P	Print	Ctrl+Alt+L	Convert selection to lowercase
Ctrl+S	Save unit	Ctrl+Alt+U	Convert selection to uppercase
Ctrl+Shift+S	Save All	Ctrl+Alt+T	Convert to Titlecase
Ctrl+V	Paste		

Software Simulator Shortcuts	
F2	Jump To Interrupt
F4	Run to Cursor
F5	Toggle Breakpoint
F6	Run/Pause Debugger
F7	Step into
F8	Step over
F9	Debug
Ctrl+F2	Reset
Ctrl+F5	Add to Watch List
Ctrl+F8	Step out
Alt+D	Dissassembly view
Shift+F5	Open Watch Window

IDE OVERVIEW

The *mikroPascal for 8051* is an user-friendly and intuitive environment:

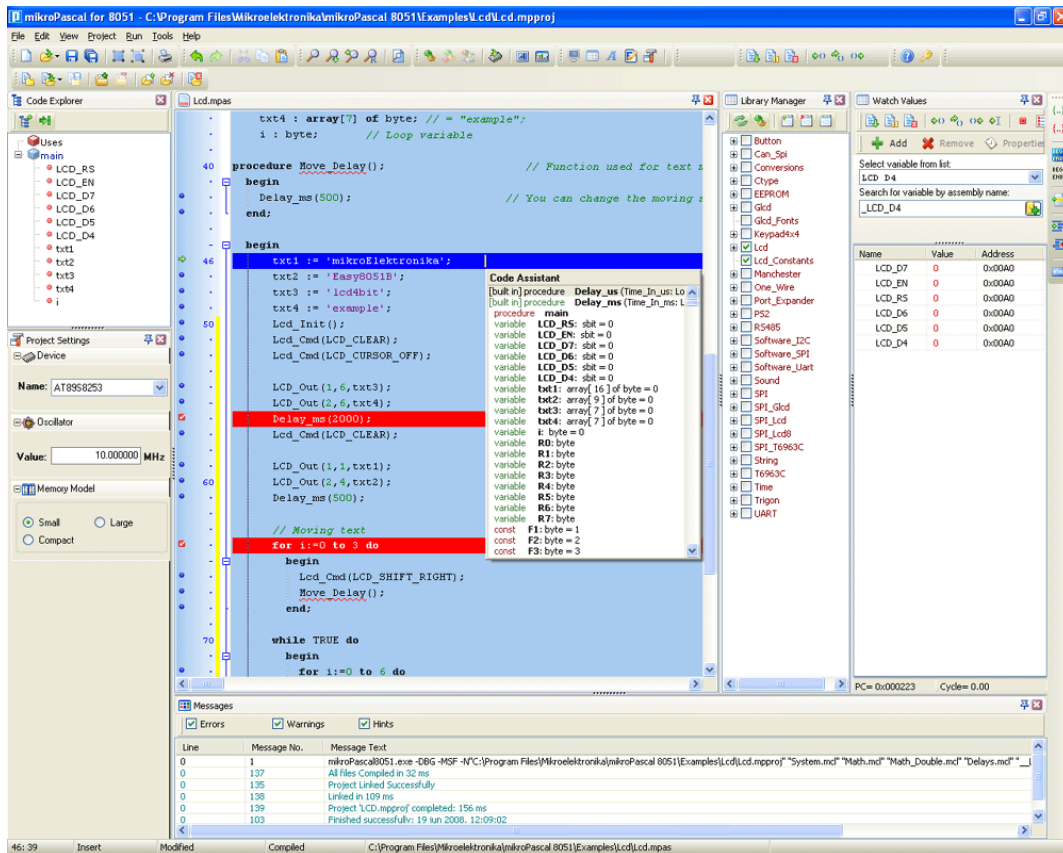

- The Code Editor features adjustable Syntax Highlighting, Code Folding, Code Assistant, Parameters Assistant, Spell Checker, Auto Correct for common typos and Code Templates (Auto Complete).
- The Code Explorer (with Keyboard shortcut browser and Quick Help browser) is at your disposal for easier project management.
- The Project Manager allows multiple project management
- General project settings can be made in the Project Settings window
- Library manager enables simple handling libraries being used in a project
- The Error Window displays all errors detected during compiling and linking.
- The source-level Software Simulator lets you debug executable logic step-by-step by watching the program flow.
- The New Project Wizard is a fast, reliable, and easy way to create a project.

- Help files are syntax and context sensitive.
- Like in any modern Windows application, you may customize the layout of *mikroPascal for 8051* to suit your needs best.
- Spell checker underlines identifiers which are unknown to the project. In this way it helps the programmer to spot potential problems early, much before the project is compiled.
Spell checker can be disabled by choosing the option in the Preferences dialog (F12).

CUSTOMIZING IDE LAYOUT

Docking Windows

You can increase the viewing and editing space for code, depending on how you arrange the windows in the IDE.

Step 1: Click the window you want to dock, to give it focus.

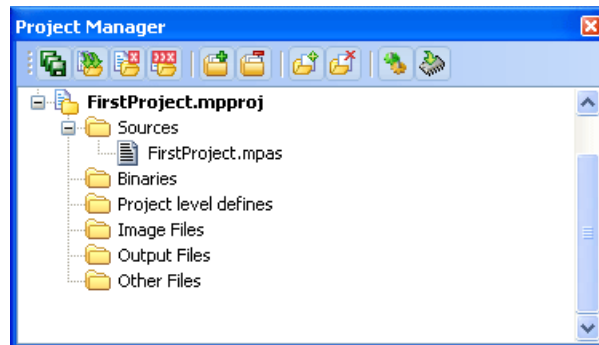

Step 2: Drag the tool window from its current location. A guide diamond appears. The four arrows of the diamond point towards the four edges of the IDE.

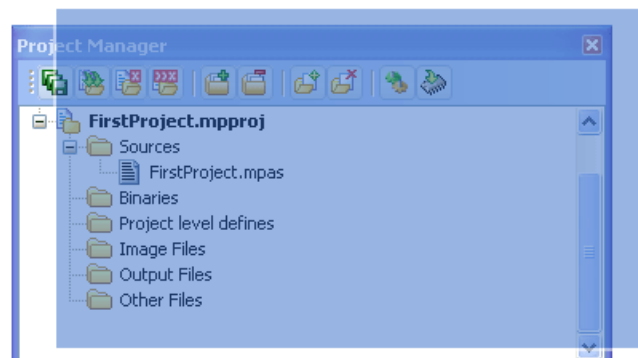

Step 3: Move the pointer over the corresponding portion of the guide diamond. An outline of the window appears in the designated area.

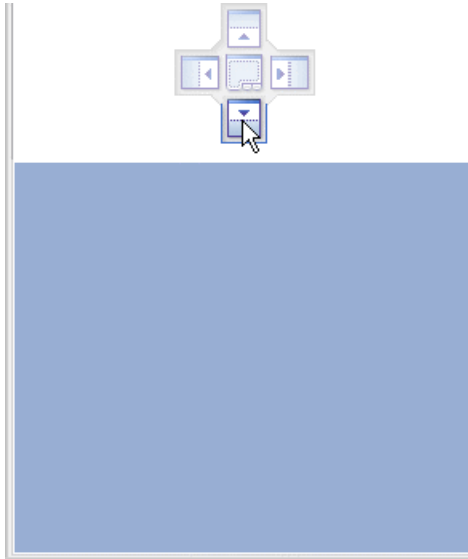



Step 4: To dock the window in the position indicated, release the mouse button.

Tip: To move a dockable window without snapping it into place, press CTRL while dragging it.

Saving Layout

Once you have a window layout that you like, you can save the layout by typing the name for the layout and pressing the Save Layout Icon  .

To set the layout select the desired layout from the layout drop-down list and click the Set Layout Icon  .

To remove the layout from the drop-down list, select the desired layout from the list and click the Delete Layout Icon  .

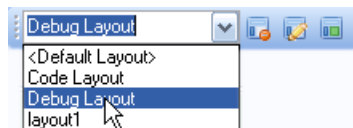

Auto Hide

Auto Hide enables you to see more of your code at one time by minimizing tool windows along the edges of the IDE when not in use.

- Click the window you want to keep visible to give it focus.
- Click the Pushpin Icon  on the title bar of the window.

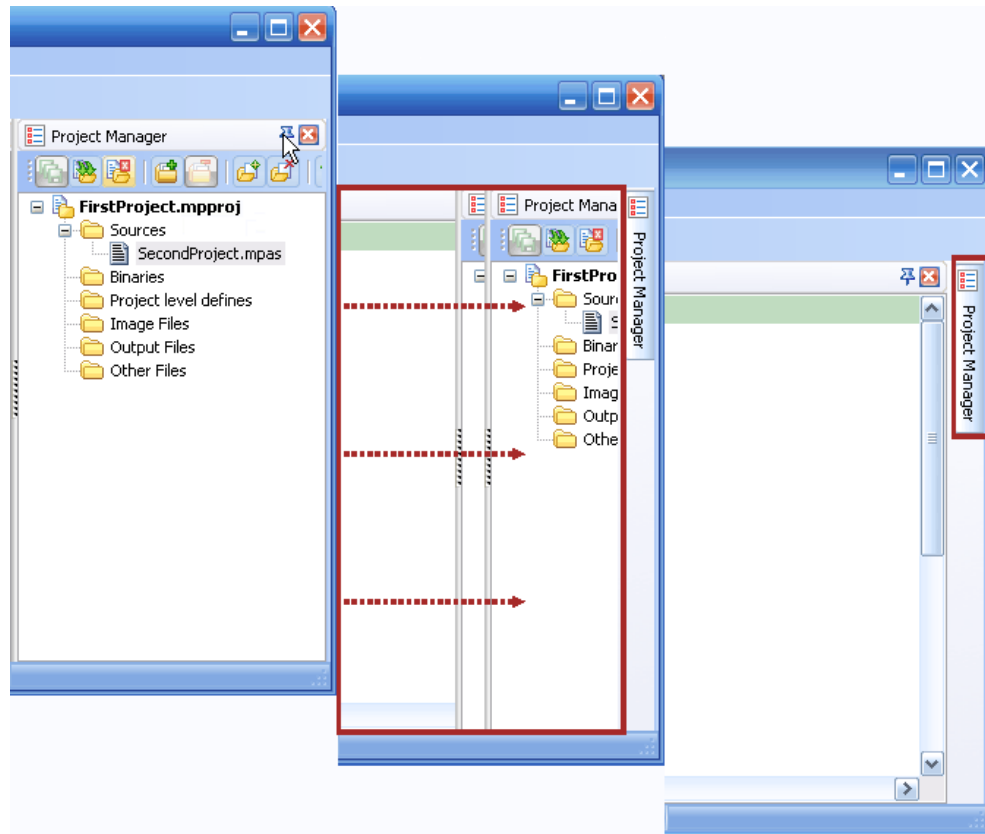

When an auto-hidden window loses focus, it automatically slides back to its tab on the edge of the IDE. While a window is auto-hidden, its name and icon are visible on a tab at the edge of the IDE. To display an auto-hidden window, move your pointer over the tab. The window slides back into view and is ready for use.

ADVANCED CODE EDITOR

The Code Editor is advanced text editor fashioned to satisfy needs of professionals. General code editing is the same as working with any standard text-editor, including familiar Copy, Paste and Undo actions, common for Windows environment.

Advanced Editor Features

- Adjustable Syntax Highlighting
- Code Assistant
- Code Folding
- Parameter Assistant
- Code Templates (Auto Complete)
- Auto Correct for common typos
- Spell Checker
- Bookmarks and Goto Line
- Comment / Uncomment

You can configure the Syntax Highlighting, Code Templates and Auto Correct from the Editor Settings dialog. To access the Settings, click **Tools** > **Options** from the drop-down menu, click the Show Options Icon  or press F12 key.

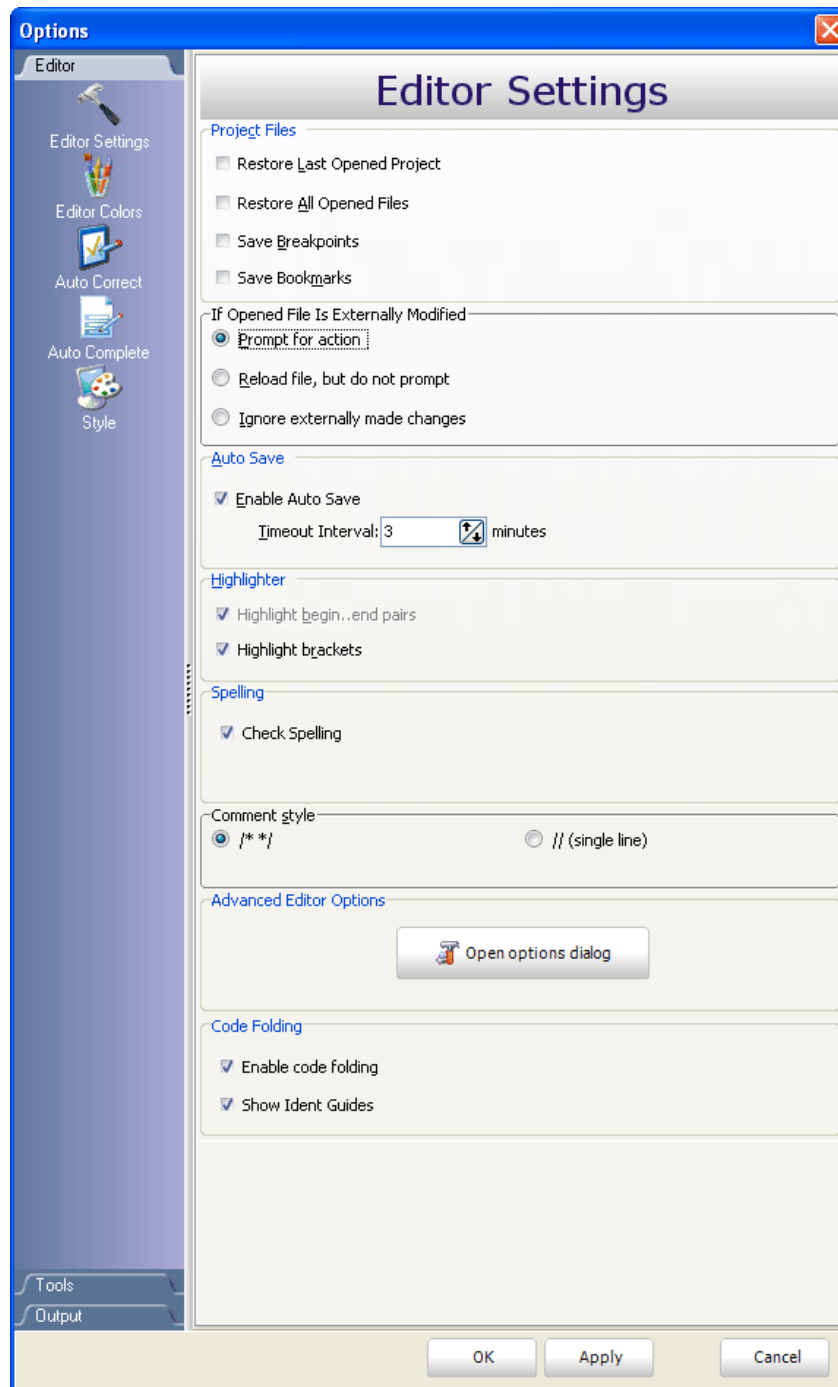

Code Assistant

If you type the first few letters of a word and then press Ctrl+Space, all valid identifiers matching the letters you have typed will be prompted in a floating panel (see the image below). Now you can keep typing to narrow the choice, or you can select one from the list using the keyboard arrows and Enter.

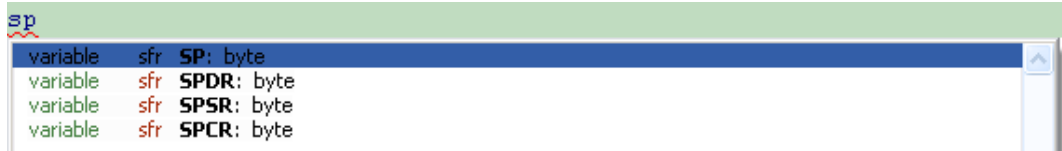

Code Folding

Code folding is IDE feature which allows users to selectively hide and display sections of a source file. In this way it is easier to manage large regions of code within one window, while still viewing only those subsections of the code that are relevant during a particular editing session.

While typing, the code folding symbols (and) appear automatically. Use the folding symbols to hide/unhide the code subsections.

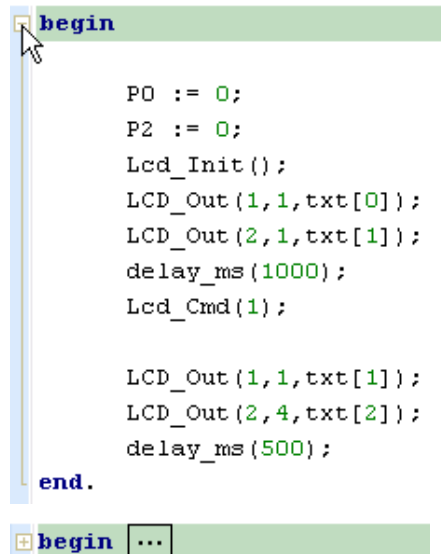

If you place a mouse cursor over the tooltip box, the collapsed text will be shown in a tooltip style box.

```

begin
    PO := 0;
    P2 := 0;
    Lcd_Init();
    LCD_Out(1,1,txt[0]);
    LCD_Out(2,1,txt[1]);
    delay_ms(1000);
    Lcd_Cmd(1);

    LCD_Out(1,1,txt[1]);
    LCD_Out(2,4,txt[2]);
    delay_ms(500);
end;

```

Parameter Assistant

The Parameter Assistant will be automatically invoked when you open parenthesis “(” or press Shift+Ctrl+Space. If the name of a valid function precedes the parenthesis, then the expected parameters will be displayed in a floating panel. As you type the actual parameter, the next expected parameter will become bold.

```

ADC_Read(

```

Code Templates (Auto Complete)

You can insert the Code Template by typing the name of the template (for instance, whiles), then press Ctrl+J and the Code Editor will automatically generate a code.

You can add your own templates to the list. Select **Tools > Options** from the drop-down menu, or click the Show Options Icon  and then select the Auto Complete Tab. Here you can enter the appropriate keyword, description and code of your template.

Autocomplete macros can retrieve system and project information:

- %DATE% - current system date
- %TIME% - current system time
- %DEVICE% - device(MCU) name as specified in project settings
- %DEVICE_CLOCK% - clock as specified in project settings
- %COMPILER% - current compiler version

These macros can be used in template code, see template `ptemplate` provided with *mikroPascal for 8051* installation.

Auto Correct

The Auto Correct feature corrects common typing mistakes. To access the list of recognized typos, select **Tools > Options** from the drop-down menu, or click the Show Options Icon  and then select the Auto Correct Tab. You can also add your own preferences to the list.

Also, the Code Editor has a feature to comment or uncomment the selected code by simple click of a mouse, using the Comment Icon  and Uncomment Icon  from the Code Toolbar.

Spell Checker

The Spell Checker underlines unknown objects in the code, so they can be easily noticed and corrected before compiling your project.

Select **Tools > Options** from the drop-down menu, or click the Show Options Icon  and then select the Spell Checker Tab.



Bookmarks

Bookmarks make navigation through a large code easier. To set a bookmark, use Ctrl+Shift+number. To jump to a bookmark, use Ctrl+number.

Goto Line

The Goto Line option makes navigation through a large code easier. Use the shortcut Ctrl+G to activate this option.

Comment / Uncomment



Also, the Code Editor has a feature to comment or uncomment the selected code by simple click of a mouse, using the Comment Icon  and Uncomment Icon  from the Code Toolbar.

CODE EXPLORER

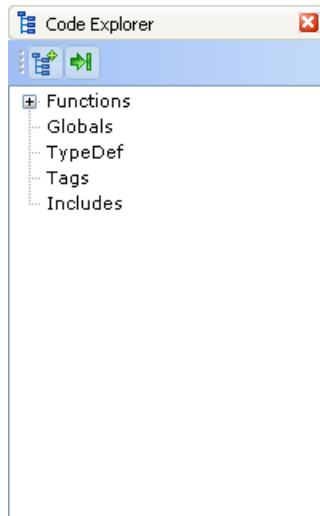
The Code Explorer gives clear view of each item declared inside the source code. You can jump to a declaration of any item by right clicking it. Also, besides the list of defined and declared objects, code explorer displays message about first error and its location in code.



Following options are available in the Code Explorer:

Icon	Description
	Expand/Collapse all nodes in tree.
	Locate declaration in code.

ROUTINE LIST

Routine list displays list of routines, and enables filtering routines by name. Routine list window can be accessed by pressing Ctrl+L.

You can jump to a desired routine by double clicking on it.

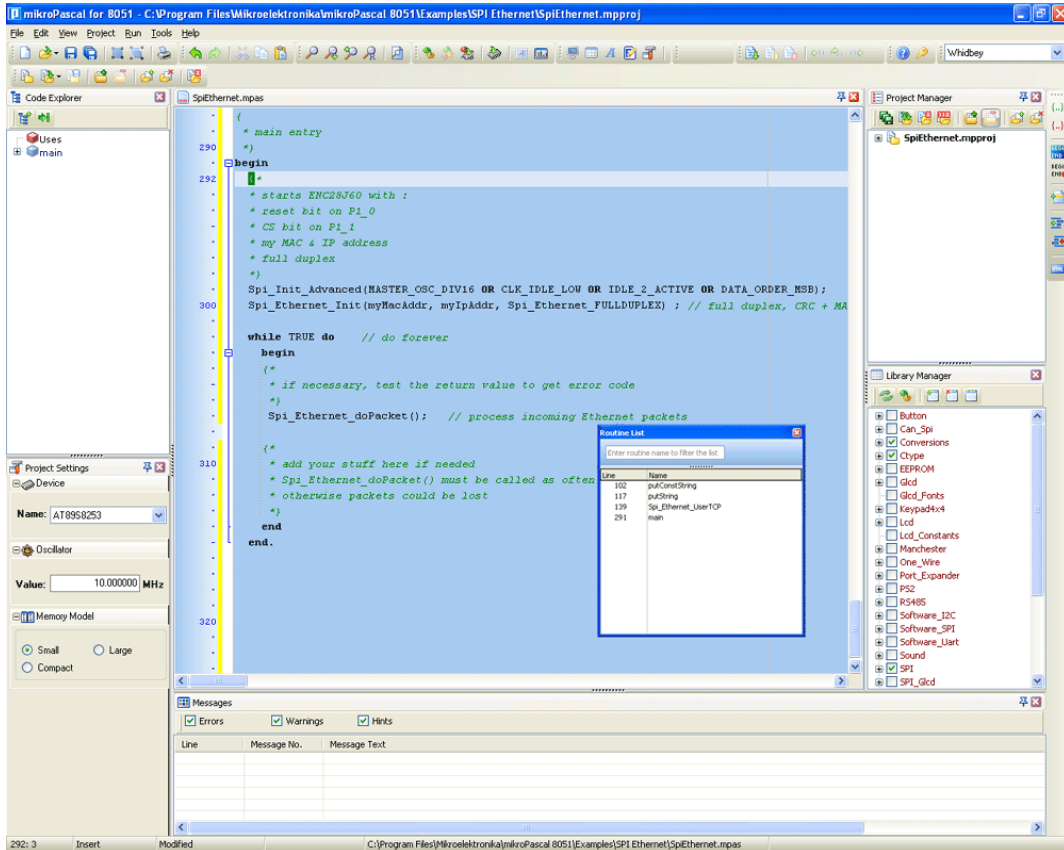





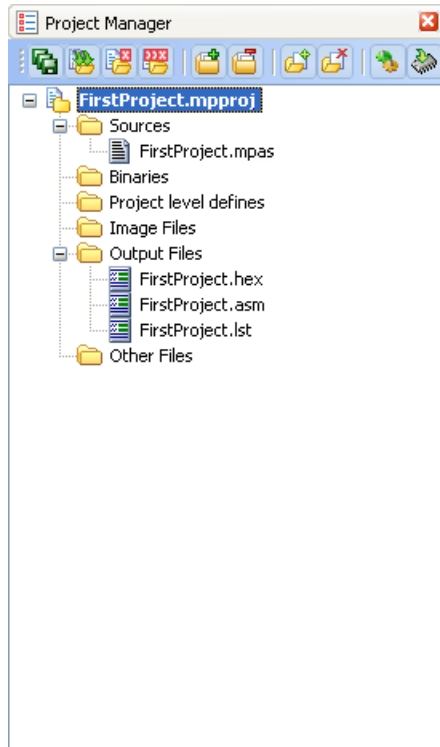





PROJECT MANAGER

Project Manager is IDE feature which allows users to manage multiple projects. Several projects which together make project group may be open at the same time. Only one of them may be active at the moment. Setting project in active mode is performed by double click on the desired project in the Project Manager.



Following options are available in the Project Manager:

Icon	Description
	Save project Group.
	Open project group.
	Close the active project.
	Close project group.
	Add project to the project group.
	Remove project from the project group.
	Add file to the active project.
	Remove selected file from the project.
	Build the active project.
	Run mikroElektronika's Flash programmer.

For details about adding and removing files from project see [Add/Remove Files from Project](#).

Related topics: [Project Settings](#), [Project Menu Options](#), [File Menu Options](#), [Project Toolbar](#), [Build Toolbar](#), [Add/Remove Files from Project](#)

PROJECT SETTINGS WINDOW

Following options are available in the Project Settings Window:

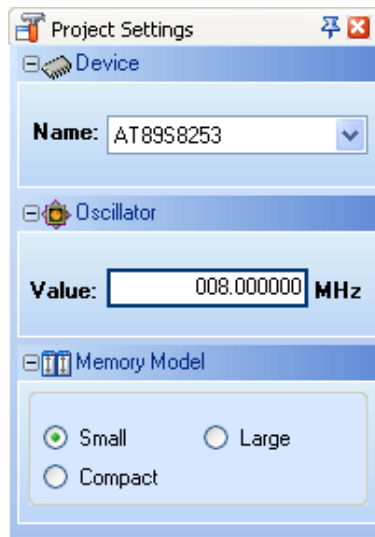

- Device - select the appropriate device from the device drop-down list.
- Oscillator - enter the oscillator frequency value.
- Memory Model - Select the desired memory model.



Related topics: Memory Model, Project Manager





LIBRARY MANAGER

Library Manager enables simple handling libraries being used in a project. Library Manager window lists all libraries (extension .mcl) which are instantly stored in the compiler Uses folder. The desirable library is added to the project by selecting check box next to the library name.

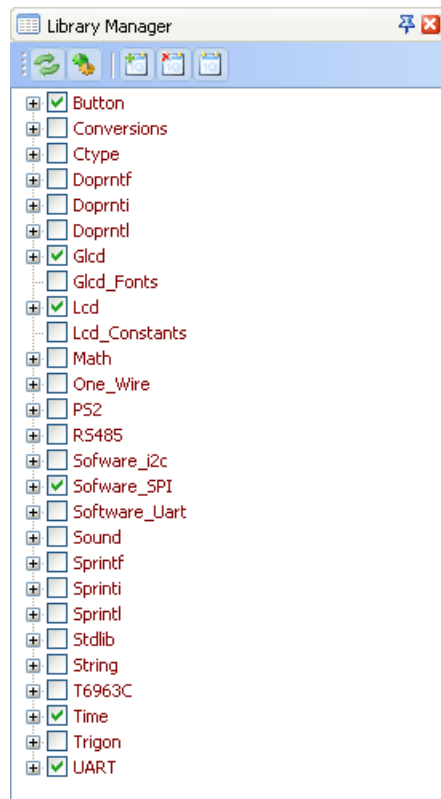
In order to have all library functions accessible, simply press the button **Check All**  and all libraries will be selected. In case none library is needed in a project, press the button **Clear All**  and all libraries will be cleared from the project.

Only the selected libraries will be linked.



Icon	Description
	Refresh Library by scanning files in "Uses" folder. Useful when new libraries are added by copying files to "Uses" folder.
	Rebuild all available libraries. Useful when library sources are available and need refreshing.
	Include all available libraries in current project.
	No libraries from the list will be included in current project.
	Restore library to the state just before last project saving.

Related topics: *mikroPascal for 8051* Libraries, Creating New Library

ERROR WINDOW

In case that errors were encountered during compiling, the compiler will report them and won't generate a hex file. The Error Window will be prompted at the bottom of the main window by default.

The Error Window is located under message tab, and displays location and type of errors the compiler has encountered. The compiler also reports warnings, but these do not affect the output; only errors can interfere with the generation of hex.

Line	Message No.	Message Text	Unit
0	1	mikroPascal8051.exe -MSF -DBG -pAT89S8253 -ES -C -O111111114 ...	
0	125	All files Preprocessed in 31 ms	
0	121	Compilation Started	LedBlinking.mpas
21	300	Syntax Error: expected ')', but ';' found	LedBlinking.mpas
21	399	; expected but 'P2' found	LedBlinking.mpas
22	421	')} expected ';' found	LedBlinking.mpas
31	421	')} expected ';' found	LedBlinking.mpas
0	102	Finished (with errors): 06 Mar 2008, 09:26:59	LedBlinking.mproj

Double click the message line in the Error Window to highlight the line where the error was encountered.

Related topics: Error Messages

STATISTICS

After successful compilation, you can review statistics of your code. Click the Statistics Icon  .

Memory Usage Windows

Provides overview of RAM and ROM usage in the form of histogram.

RAM Memory

Data Memory

Displays Data memory usage in form of histogram.

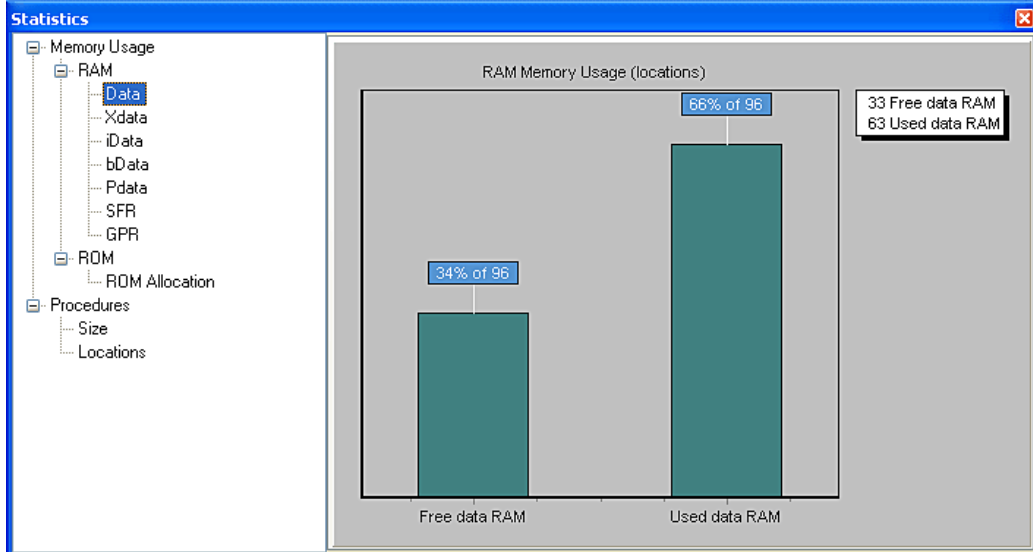

XData Memory

Displays XData memory usage in form of histogram.

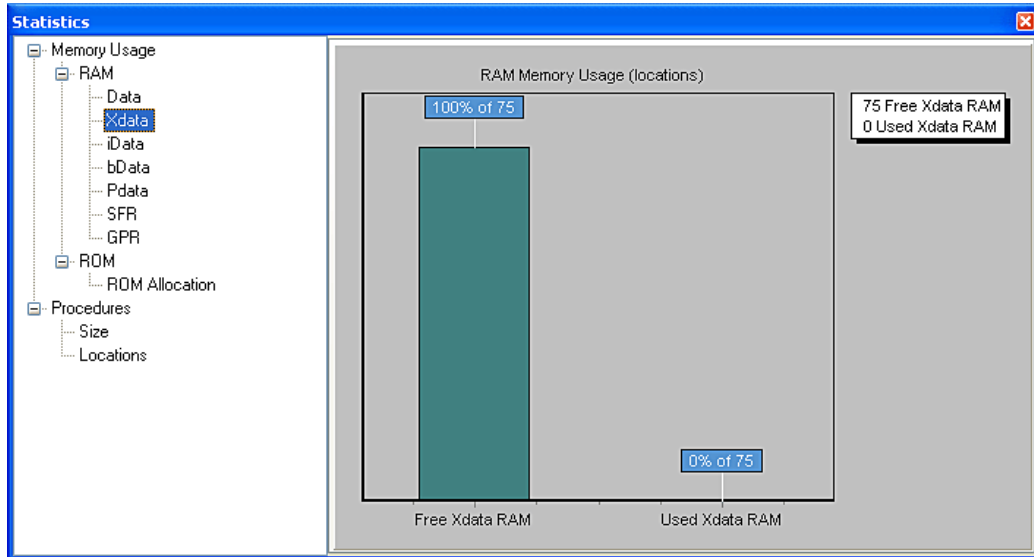

iData Memory

Displays iData memory usage in form of histogram.

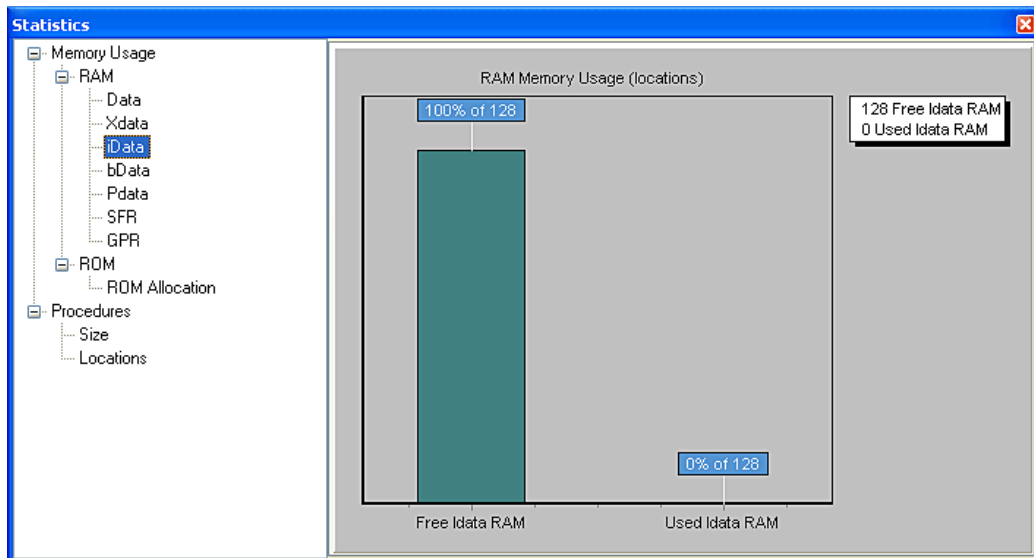

bData Memory

Displays bData memory usage in form of histogram.

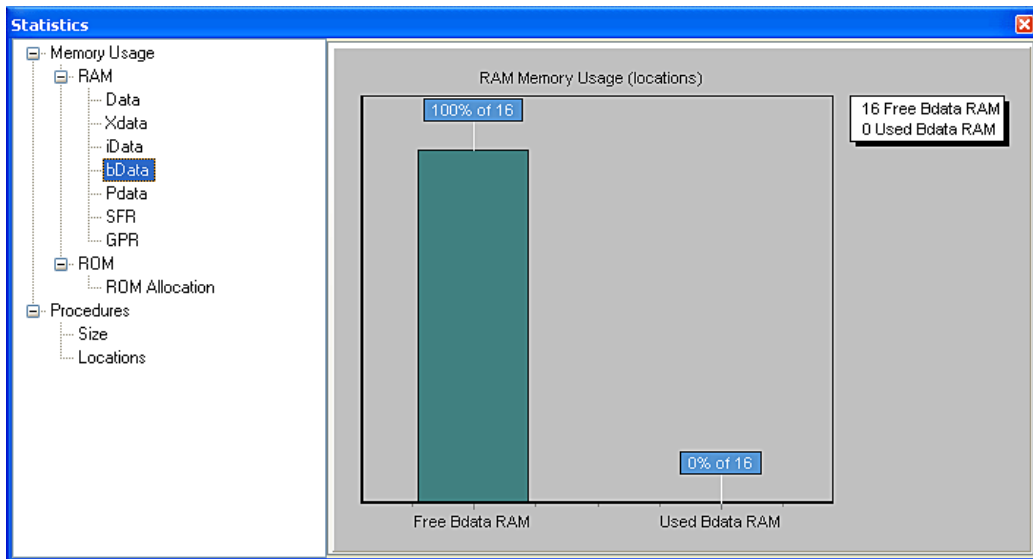

PData Memory

Displays PData memory usage in form of histogram.

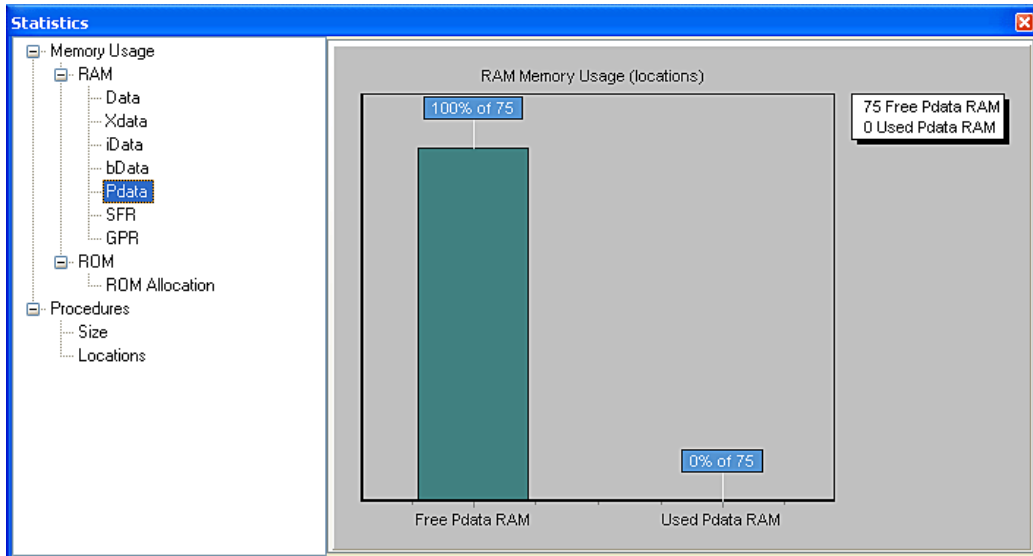

Special Function Registers

Summarizes all Special Function Registers and their addresses.

The screenshot shows the 'Statistics' window with the 'SFR' option selected in the left-hand tree view. The main area displays a table titled 'Special function registers (SFR)' with the following data:

Address	Register
0x80	P0
0x81	SP
0x82	DPL
0x82	DPOL
0x83	DPH
0x83	DPOH
0x84	DP1L
0x85	DP1H
0x86	SPDR
0x87	PCON
0x88	TCON
0x89	TMOD
0x8A	TL0
0x8B	TL1
0x8C	TH0

General Purpose Registers

Summarizes all General Purpose Registers and their addresses. Also displays symbolic names of variables and their addresses.

The screenshot shows the 'Statistics' window with the 'GPR' option selected in the left-hand tree view. The main area displays a table titled 'General purpose registers (GPR)' with the following data:

Address	Register
0x00	R0
0x01	R1
0x02	R2
0x03	R3
0x04	R4
0x05	R5
0x06	R6
0x07	R7
0x09C0	advanced8051_bmp (_advanced8051_bmp)
0xA0	GLCD_CS1 (_GLCD_CS1)
0xA1	GLCD_CS2 (_GLCD_CS2)
0xA2	GLCD_RS (_GLCD_RS)
0xA3	GLCD_RW (_GLCD_RW)
0xA5	GLCD_RST (_GLCD_RST)
0xA4	GLCD_EN (_GLCD_EN)

ROM Memory

ROM Memory Usage

Displays ROM memory usage in form of histogram.

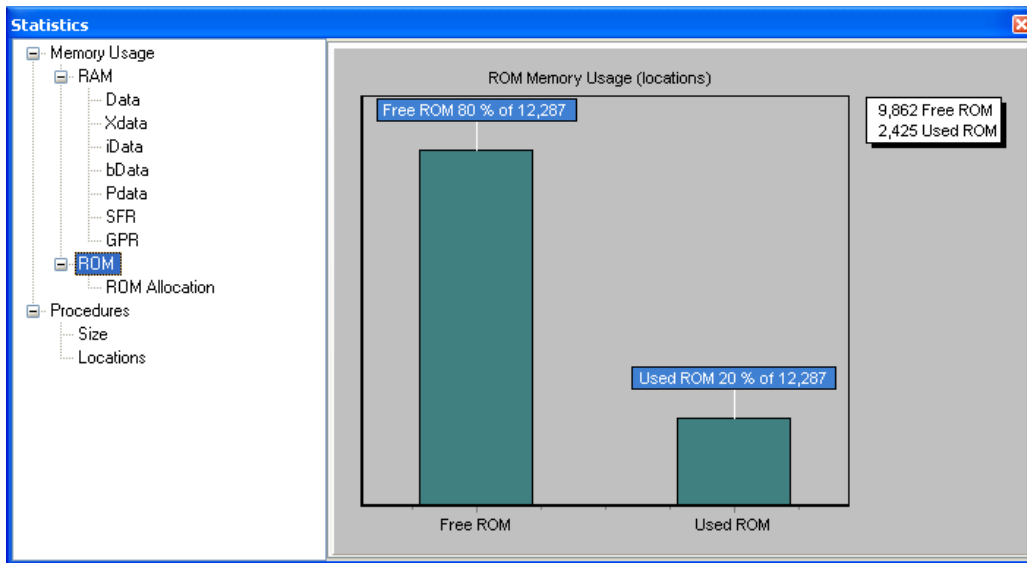

ROM Memory Allocation

Displays ROM memory allocation.

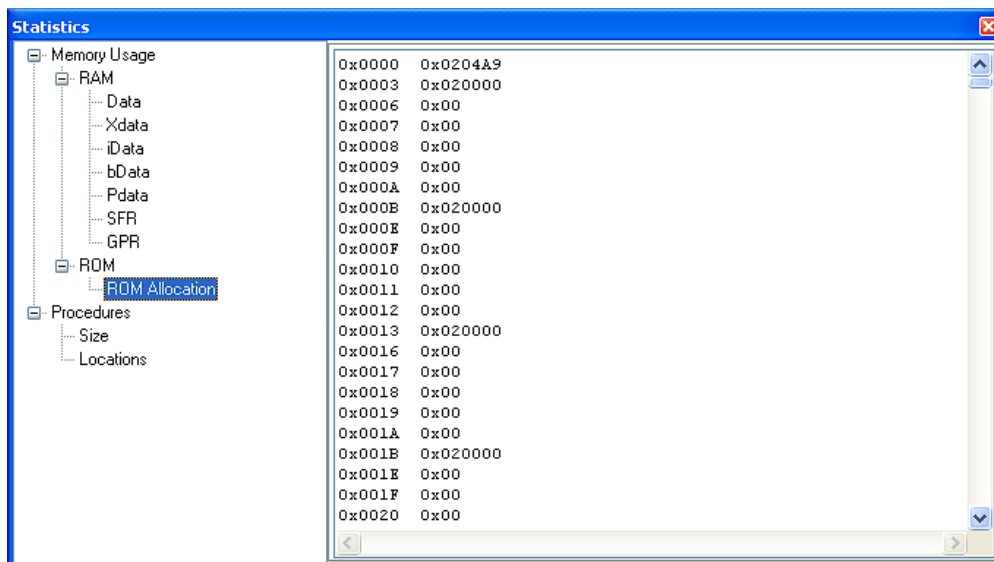

Procedures Windows

Provides overview procedures locations and sizes.

Procedures Size Window

Displays size of each procedure.

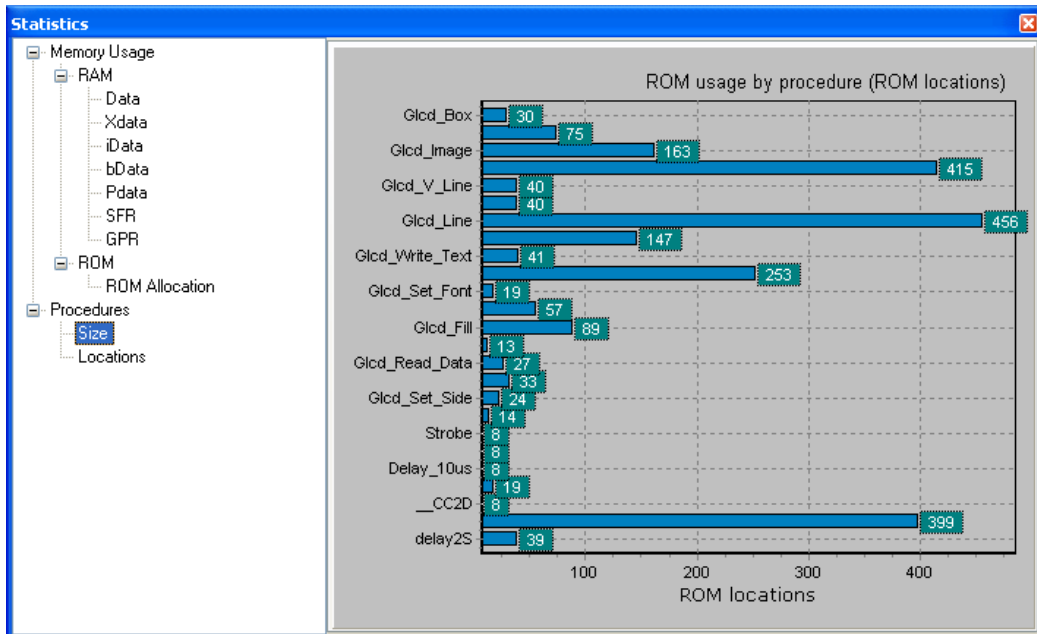

Procedures Locations Window

Displays how functions are distributed in microcontroller's memory.

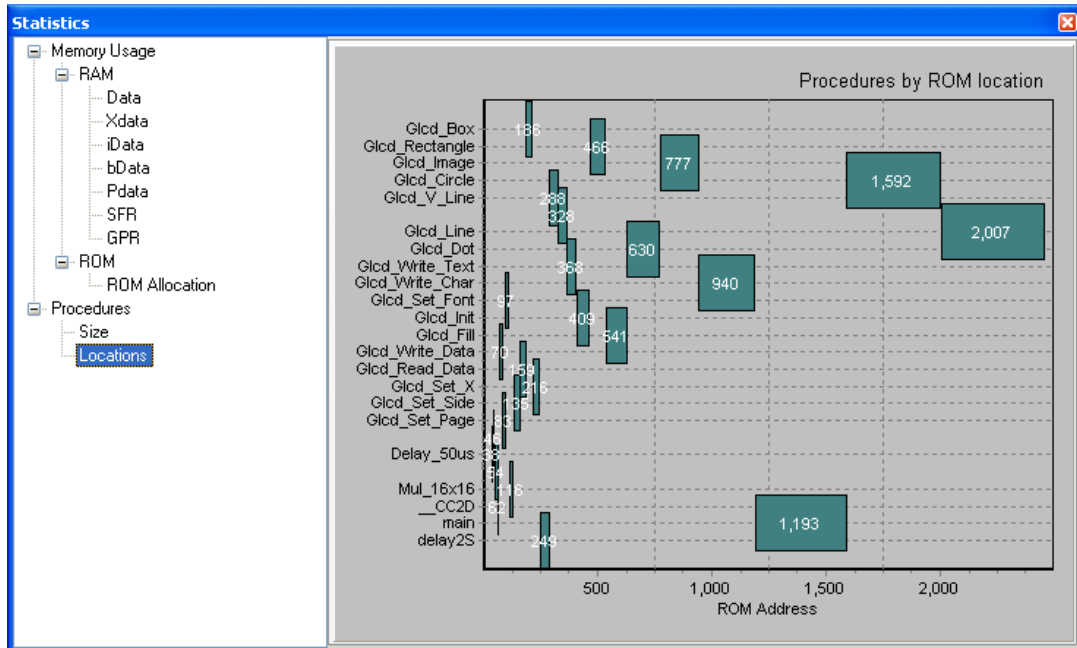

INTEGRATED TOOLS

USART Terminal

The *mikroPascal for 8051* includes the USART communication terminal for RS232 communication. You can launch it from the drop-down menu **Tools** › **USART Terminal** or by clicking the USART Terminal Icon  from Tools toolbar.

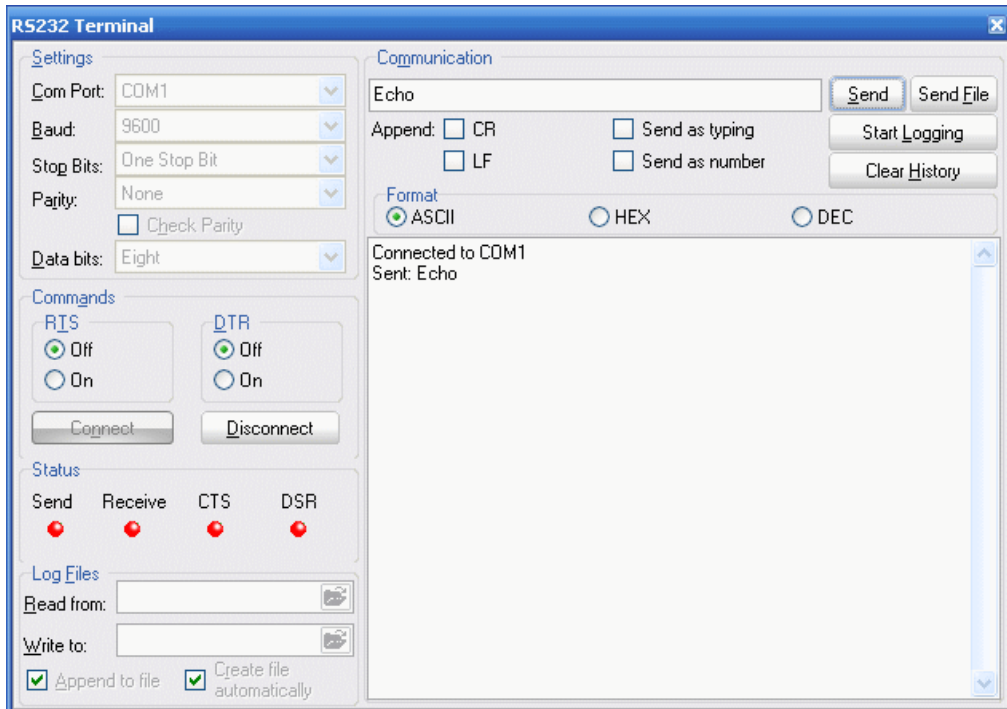

ASCII Chart

The ASCII Chart is a handy tool, particularly useful when working with LCD display. You can launch it from the drop-down menu **Tools > ASCII chart** or by clicking the View ASCII Chart Icon  from Tools toolbar.

Ascii Chart																
	0	1	2	3	4	5	6	7	8	9	A	B	C	D	E	F
0	NUL	SOH	STX	ETX	EOT	ENQ	ACK	BEL	BS	HT	LF	VT	FF	CR	SO	SI
1	DLE	DC1	DC2	DC3	DC4	NAK	SYN	ETB	CAN	EM	SUB	ESC	FS	GS	RS	US
2	SPC	!	"	#	\$	%	_	'	()	*	+	,	-	.	/
3	0	1	2	3	4	5	6	7	8	9	:	;	<	=	>	?
4	@	A	B	C	D	E	F	G	H	I	J	K	L	M	N	O
5	P	Q	R	S	T	U	V	W	X	Y	Z	[\]	^	_
6	`	a	b	c	d	e	f	g	h	i	j	k	l	m	n	o
7	p	q	r	s	t	u	v	w	x	y	z	{		}	~	DEL
8	€	□	,	f	„	...	†	‡	^	%o	Š	<	œ	□	ž	□
9	□	'	'	“	”	•	-	-	~	™	š	>	œ	□	ž	ÿ
A	i	φ	£	¤	¥	¦	§	¨	©	a	«	¬	-	®		
B	°	±	²	³	´	µ	¶	·	¸	¹	º	»	¼	½	¾	¿
C	À	Á	Â	Ã	Ä	Å	Æ	Ç	È	É	Ê	Ë	Ì	Í	Î	Ï
D	Ð	Ñ	Ò	Ó	Ô	Õ	Ö	×	Ø	Ù	Ú	Û	Ü	Ý	Þ	ß
E	à	á	â	ã	ä	å	æ	ç	è	é	ê	ë	ì	í	î	ï
F	ð	ñ	ò	ó	ô	õ	ö	÷	ø	ù	ú	û	ü	ý	þ	ÿ

EEPROM Editor

The EEPROM Editor is used for manipulating MCU's EEPROM memory. You can launch it from the drop-down menu **Tools** > **EEPROM Editor**. When Use this EEPROM definition is checked compiler will generate Intel hex file `project_name.ihex` that contains data from EEPROM editor.

When you run mikroElektronika programmer software from *mikroPascal for 8051* IDE - `project_name.hex` file will be loaded automatically while `ihex` file must be loaded manually.

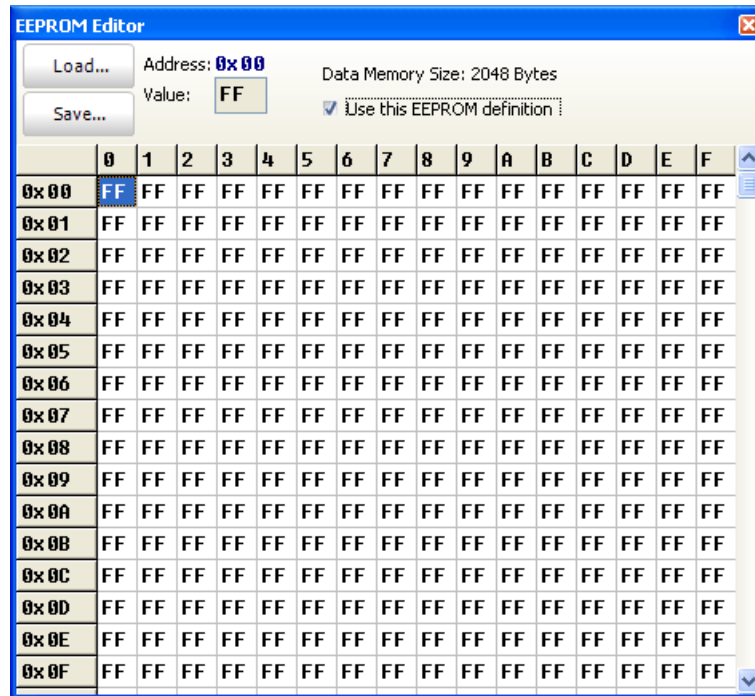

7 Segment Display Decoder

The 7 Segment Display Decoder is a convenient visual panel which returns decimal/hex value for any viable combination you would like to display on 7seg. Click on the parts of 7 segment image to get the requested value in the edit boxes. You can launch it from the drop-down menu **Tools** > **7 Segment Decoder** by clicking the Seven Segment Icon  from Tools toolbar.

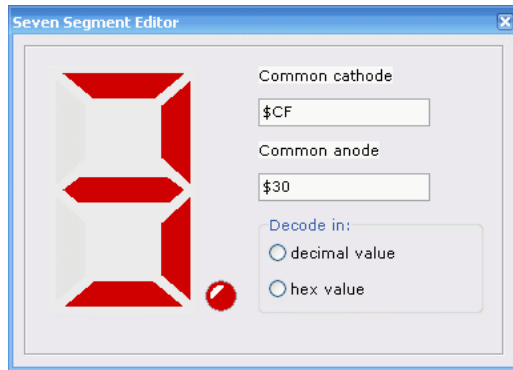

UDP Terminal

The *mikroPascal for 8051* includes the UDP Terminal. You can launch it from the drop-down menu **Tools** > **UDP Terminal**.

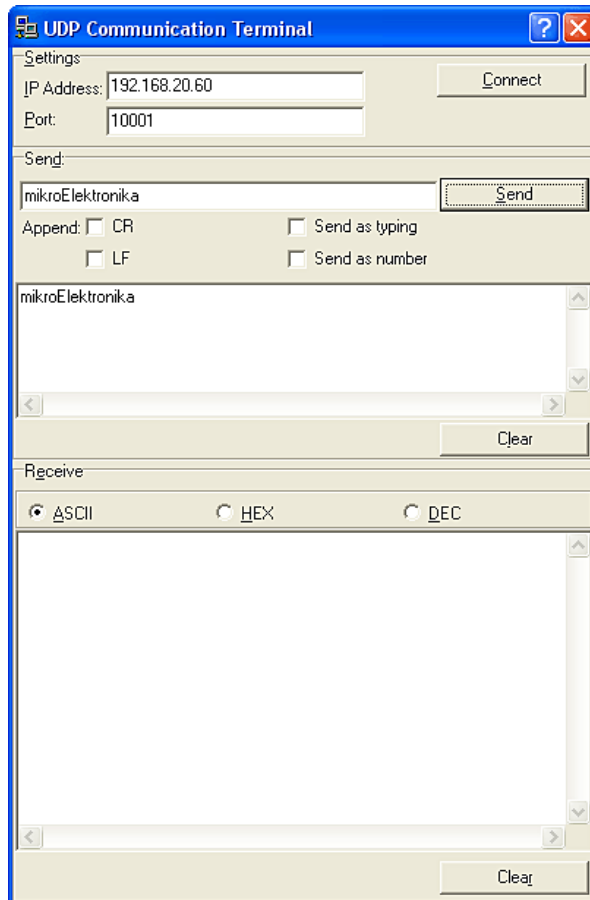

Graphic LCD Bitmap Editor

The *mikroPascal for 8051* includes the Graphic LCD Bitmap Editor. Output is the *mikroPascal for 8051* compatible code. You can launch it from the drop-down menu **Tools › GLCD Bitmap Editor**.

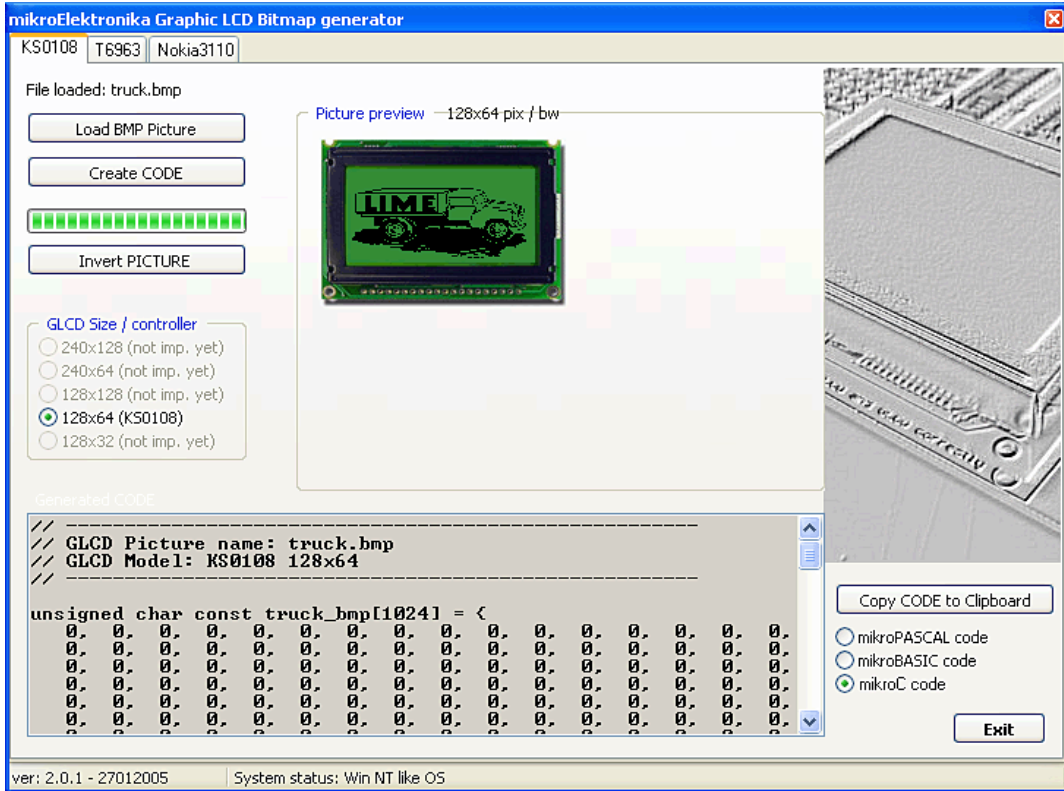

LCD Custom Character

mikroPascal for 8051 includes the LCD Custom Character. Output is *mikroPascal for 8051* compatible code. You can launch it from the drop-down menu **Tools** > **LCD Custom Character**.

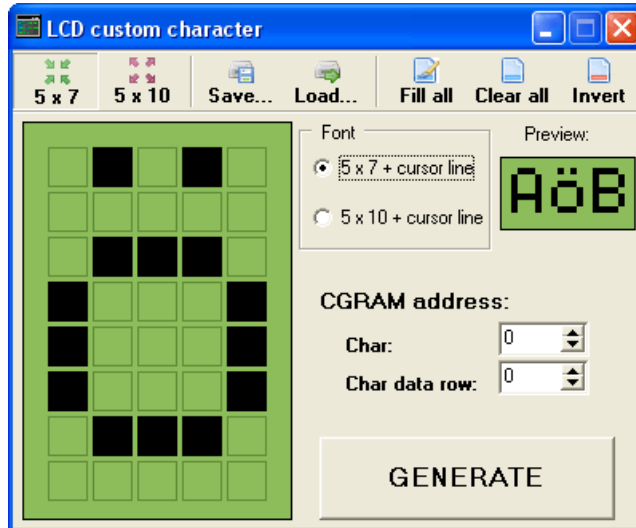

OPTIONS

Options menu consists of three tabs: Code Editor, Tools and Output settings

Code editor

The Code Editor is advanced text editor fashioned to satisfy needs of professionals.

Tools

The *mikroPascal for 8051* includes the Tools tab, which enables the use of shortcuts to external programs, like Calculator or Notepad.

You can set up to 10 different shortcuts, by editing Tool0 - Tool9.

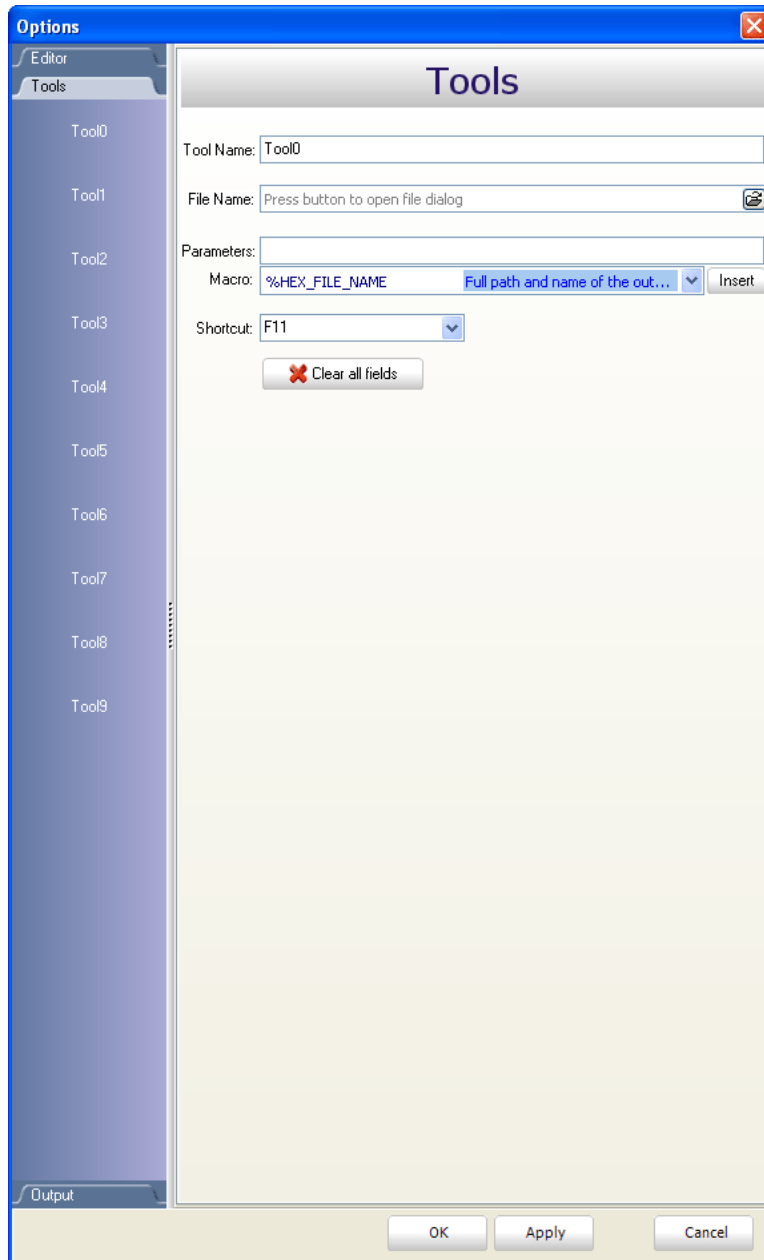

Output settings

By modifying Output Settings, user can configure the content of the output files. You can enable or disable, for example, generation of ASM and List file.

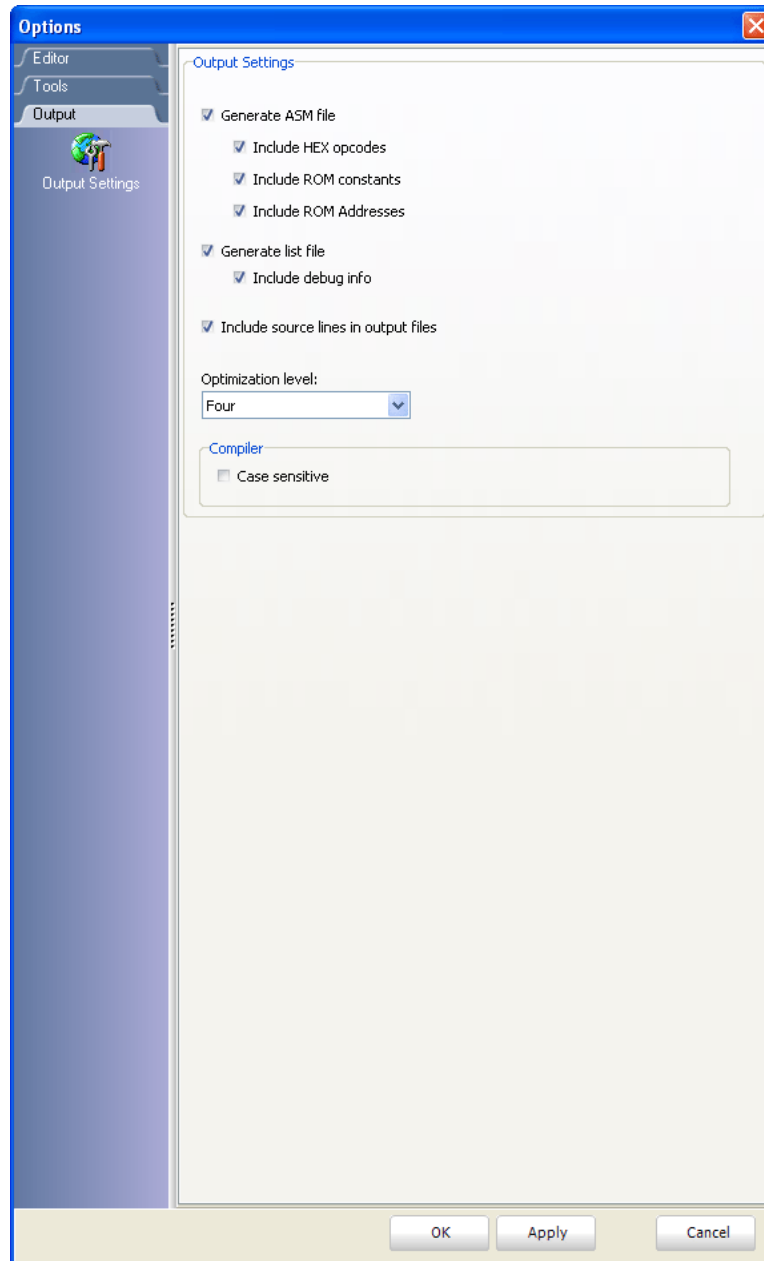

REGULAR EXPRESSIONS

Introduction

Regular Expressions are a widely-used method of specifying patterns of text to search for. Special metacharacters allow you to specify, for instance, that a particular string you are looking for, occurs at the beginning, or end of a line, or contains n recurrences of a certain character.

Simple matches

Any single character matches itself, unless it is a metacharacter with a special meaning described below. A series of characters matches that series of characters in the target string, so the pattern "short" would match "short" in the target string. You can cause characters that normally function as metacharacters or escape sequences to be interpreted by preceding them with a backslash "\". For instance, metacharacter "^" matches beginning of string, but "\^" matches character "^", and "\\\" matches "\", etc.

Examples :

```
integer matches string 'integer'
\^integer matches string '^integer'
```

Escape sequences

Characters may be specified using a escape sequences: "\n" matches a newline, "\t" a tab, etc. More generally, \xnn, where nn is a string of hexadecimal digits, matches the character whose ASCII value is nn.

If you need wide(Unicode)character code, you can use '\x{ nnnn} ', where 'nnnn' - one or more hexadecimal digits.

```
\xnn - char with hex code nn
\x{ nnnn} - char with hex code nnnn (one byte for plain text and two bytes
for Unicode)
\t - tab (HT/TAB), same as \x09
\n - newline (NL), same as \x0a
\r - car.return (CR), same as \x0d
\f - form feed (FF), same as \x0c
\a - alarm (bell) (BEL), same as \x07
\e - escape (ESC) , same as \x1b
```

Examples:

```
procedure\x20Write matches 'procedure Write' (note space in the  
middle)  
\tlongint matches 'longint' (predecessed by tab)
```

Character classes

You can specify a character class, by enclosing a list of characters in `[]`, which will match any of the characters from the list. If the first character after the `"["` is `"^"`, the class matches any character not in the list.

Examples:

```
count[aeiou]r finds strings 'countar', 'counter', etc. but not  
'countbr', 'countcr', etc.  
count[^aeiou]r finds strings 'countbr', 'countcr', etc. but not  
'countar', 'counter', etc.
```

Within a list, the `"-"` character is used to specify a range, so that `a-z` represents all characters between `"a"` and `"z"`, inclusive.

If you want `"-"` itself to be a member of a class, put it at the start or end of the list, or escape it with a backslash.

If you want `']'`, you may place it at the start of list or escape it with a backslash.

Examples:

```
[ -az] matches 'a', 'z' and '-'  
[ az-] matches 'a', 'z' and '-'  
[ a\ -z] matches 'a', 'z' and '-'  
[ a-z] matches all twenty six small characters from 'a' to 'z'  
[ \n-\x0D] matches any of #10,#11,#12,#13.  
[ \d-t] matches any digit, '-' or 't'.  
[ ]-a] matches any char from ']'..'a'.
```

Metacharacters

Metacharacters are special characters which are the essence of regular expressions. There are different types of metacharacters, described below.

Metacharacters - Line separators

- `^` - start of line
- `$` - end of line
- `\A` - start of text
- `\Z` - end of text
- `.` - any character in line

Examples:

- `^PORTA` - matches string ' PORTA ' only if it's at the beginning of line
- `PORTA$` - matches string ' PORTA ' only if it's at the end of line
- `^PORTA$` - matches string ' PORTA ' only if it's the only string in line
- `PORT.r` - matches strings like 'PORTA', 'PORTB', 'PORT1' and so on

The "`^`" metacharacter by default is only guaranteed to match beginning of the input string/text, and the "`$`" metacharacter only at the end. Embedded line separators will not be matched by "`^`" or "`$`".

You may, however, wish to treat a string as a multi-line buffer, such that the "`^`" will match after any line separator within the string, and "`$`" will match before any line separator.

Regular expressions works with line separators as recommended at www.unicode.org (<http://www.unicode.org/unicode/reports/tr18/>):

Metacharacters - Predefined classes

- `\w` - an alphanumeric character (including "_")
- `\W` - a nonalphanumeric
- `\d` - a numeric character
- `\D` - a non-numeric
- `\s` - any space (same as `[\t\n\r\f]`)
- `\S` - a non space

You may use `\w`, `\d` and `\s` within custom character classes.

Example:

`routi\de` - matches strings like 'routile', 'routi6e' and so on, but not 'routine', 'routime' and so on.

Metacharacters - Word boundaries

A word boundary ("`\b`") is a spot between two characters that has a "`\w`" on one side of it and a "`\W`" on the other side of it (in either order), counting the imaginary characters off the beginning and end of the string as matching a "`\w`".

- `\b` - match a word boundary)
- `\B` - match a non-(word boundary)

Metacharacters - Iterators

Any item of a regular expression may be followed by another type of metacharacters - iterators. Using this metacharacters, you can specify number of occurrences of previous character, metacharacter or subexpression.

- `*` - zero or more ("greedy"), similar to `{0,}`
- `+` - one or more ("greedy"), similar to `{1,}`
- `?` - zero or one ("greedy"), similar to `{0,1}`
- `{ n}` - exactly `n` times ("greedy")
- `{ n,}` - at least `n` times ("greedy")
- `{ n, m}` - at least `n` but not more than `m` times ("greedy")
- `*?` - zero or more ("non-greedy"), similar to `{0,}?`
- `+`? - one or more ("non-greedy"), similar to `{1,}?`
- `??` - zero or one ("non-greedy"), similar to `{0,1}?`
- `{ n}?` - exactly `n` times ("non-greedy")
- `{ n,}?` - at least `n` times ("non-greedy")
- `{ n, m}?` - at least `n` but not more than `m` times ("non-greedy")

So, digits in curly brackets of the form, `{ n, m}`, specify the minimum number of times to match the item `n` and the maximum `m`. The form `{ n}` is equivalent to `{ n, n}` and matches exactly `n` times. The form `{ n,}` matches `n` or more times. There is no limit to the size of `n` or `m`, but large numbers will chew up more memory and slow down execution.

If a curly bracket occurs in any other context, it is treated as a regular character.

Examples:

```

count.*r  β- matches strings like 'counter', 'countelkjdf1kj9r' and
'countr'
count.+r - matches strings like 'counter', 'countelkjdf1kj9r' but not
'countr'
count.?r - matches strings like 'counter', 'countar' and 'countr' but not
'countelkj9r'
counte{2}r - matches string 'counteer'
counte{2,}r - matches strings like 'counteer', 'counteeer', 'counteeer' etc.
counte{2,3}r - matches strings like 'counteer', or 'counteeer' but not
'counteeeer'

```

A little explanation about "greediness". "Greedy" takes as many as possible, "non-greedy" takes as few as possible.

For example, 'b+' and 'b*' applied to string 'abbbbc' return 'bbbb', 'b+?' returns 'b', 'b*?' returns empty string, 'b{2,3}?' returns 'bb', 'b{2,3}' returns 'bbb'.

Metacharacters - Alternatives

You can specify a series of alternatives for a pattern using "|" to separate them, so that `bit|bat|bot` will match any of "bit", "bat", or "bot" in the target string (as would `b(i|a|o)t`). The first alternative includes everything from the last pattern delimiter ("(", "[", or the beginning of the pattern) up to the first "|", and the last alternative contains everything from the last "|" to the next pattern delimiter. For this reason, it's common practice to include alternatives in parentheses, to minimize confusion about where they start and end.

Alternatives are tried from left to right, so the first alternative found for which the entire expression matches, is the one that is chosen. This means that alternatives are not necessarily greedy. For example: when matching `rou|rout` against "routine", only the "rou" part will match, as that is the first alternative tried, and it successfully matches the target string (this might not seem important, but it is important when you are capturing matched text using parentheses.) Also remember that "|" is interpreted as a literal within square brackets, so if you write `[bit|bat|bot]`, you're really only matching `[biao|]`.

Examples:

```
rou(tine|te) - matches strings 'routine' or 'route'.
```

Metacharacters - Subexpressions

The bracketing construct (...) may also be used for define regular subexpressions. Subexpressions are numbered based on the left to right order of their opening parenthesis. First subexpression has number '1'

Examples:

```
(int){ 8,10} matches strings which contain 8, 9 or 10 instances of the 'int'  
routi([ 0-9] |a+)e matches 'routi0e', 'routi1e', 'routine', 'routinne',  
'routinnne' etc.
```

Metacharacters - Backreferences

Metacharacters \1 through \9 are interpreted as backreferences. \ matches previously matched subexpression #.

Examples:

```
(.)\1+ matches 'aaaa' and 'cc'.  
(+)\1+ matches 'abab' and '123123'  
(["']?) (\d+)\1 matches "13" (in double quotes), or '4' (in single quotes)  
or 77 (without quotes) etc
```

mikroPascal for 8051 COMMAND LINE OPTIONS

Usage: mikroPascal8051 [-'opts' ['-opts']] ['infile' ['-opts']] [-'opts']] Infile can be of *.mpas and *.mcl type.

The following parameters and some more (see manual) are valid:

- P : MCU for which compilation will be done.
- FO : Set oscillator.
- SP : Add directory to the search path list.
- N : Output files generated to file path specified by filename.
- B : Save compiled binary files (*.mcl) to 'directory'.
- O : Miscellaneous output options.
- DBG : Generate debug info.
- E : Set memory model opts (S | C | L (small, compact, large)).
- L : Check and rebuild new libraries.
- C : Turn on case sensitivity.

Example:

```
mikroPascal8051.exe -MSF -DBG -pAT89S8253 -ES -O11111114 -fo10
-N"C:\Lcd\Lcd.mpproj" -SP"C:\Program
Files\Mikroelektronika\mikroPascal 8051\defs\"
-SP"C:\Program Files\Mikroelektronika\mikroPascal
8051\uses\"
-SP"C:\Lcd\" "Lcd.mpas" "System.mcl" "Math.mcl"
"Math_Double.mcl" "Delays.mcl" "__Lib_Lcd.mcl" "__Lib_LcdConsts.mcl"
```

Parameters used in the example:

- MSF : Short Message Format; used for internal purposes by IDE.
- DBG : Generate debug info.
- pAT89S8253 : MCU AT89S8253 selected.
- ES : Set small memory model.
- O11111114 : Miscellaneous output options.
- fo10 : Set oscillator frequency [in MHz].
- N"C:\Lcd\Lcd.mpproj" -SP"C:\Program Files\Mikroelektronika\mikroPascal 8051\defs\" : Output files generated to file path specified by filename.
- SP"C:\Program Files\Mikroelektronika\mikroPascal 8051\defs\" : Add directory to the search path list.
- SP"C:\Program Files\Mikroelektronika\mikroPascal 8051\uses\" : Add directory to the search path list.
- SP"C:\Lcd\" : Add directory to the search path list.
- "Lcd.mpas" "System.mcl" "Math.mcl" "Math_Double.mcl" "Delays.mcl" "__Lib_Lcd.mcl" "__Lib_LcdConsts.mcl" : Specify input files.

PROJECTS

The mikroPascal 8051 organizes applications into projects, consisting of a single project file (extension `.mproj`) and one or more source files (extension `.mpas`). *mikroPascal for 8051* IDE allows you to manage multiple projects (see Project Manager). Source files can be compiled only if they are part of a project.

The project file contains the following information:

- project name and optional description,
- target device,
- memory model,
- device flags (config word),
- device clock,
- list of the project source files with paths,
- binary files (*.mcl),
- image files,
- other files.

Note that the project does not include files in the same way as preprocessor does, see Add/Remove Files from Project.

New Project

The easiest way to create a project is by means of the New Project Wizard, drop-down menu **Project > New Project** or by clicking the New Project Icon  from Project Toolbar.

New Project Wizard Steps

Step One- Provides basic information on settings in the following steps.

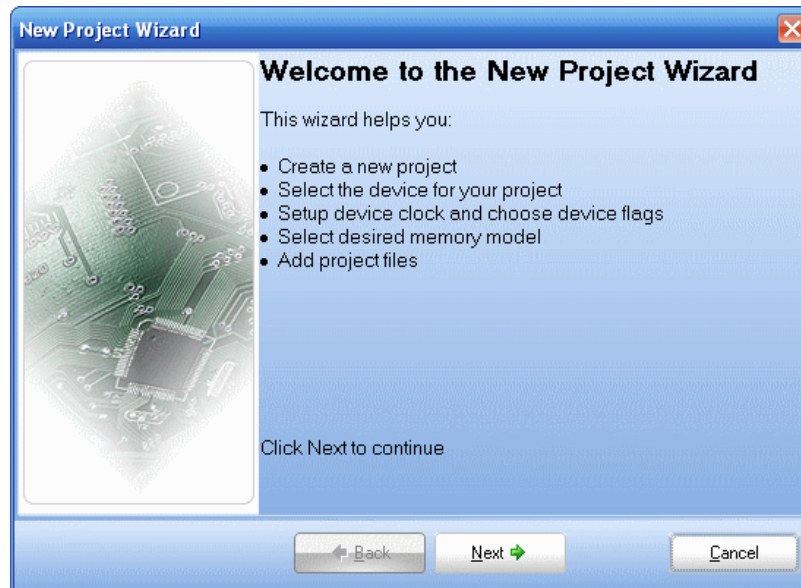

Step Two - Select the device from the device drop-down list.

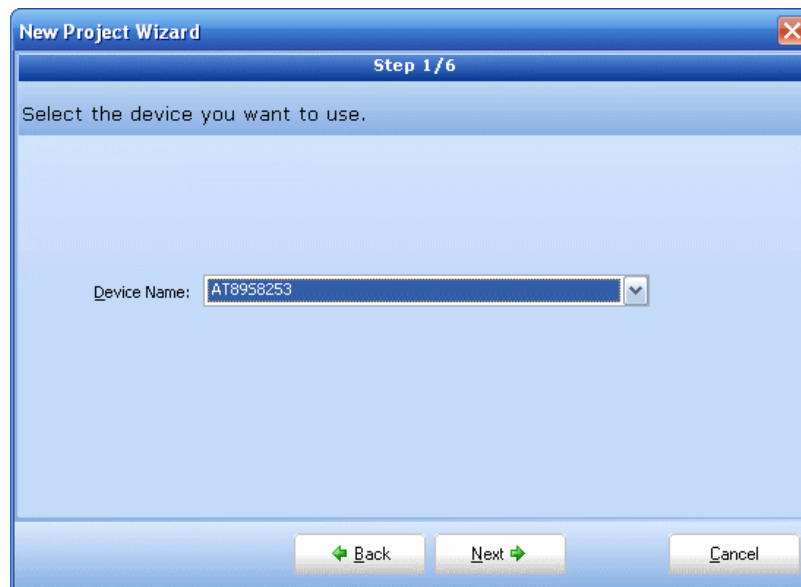

Step Three - enter the oscillator frequency value.

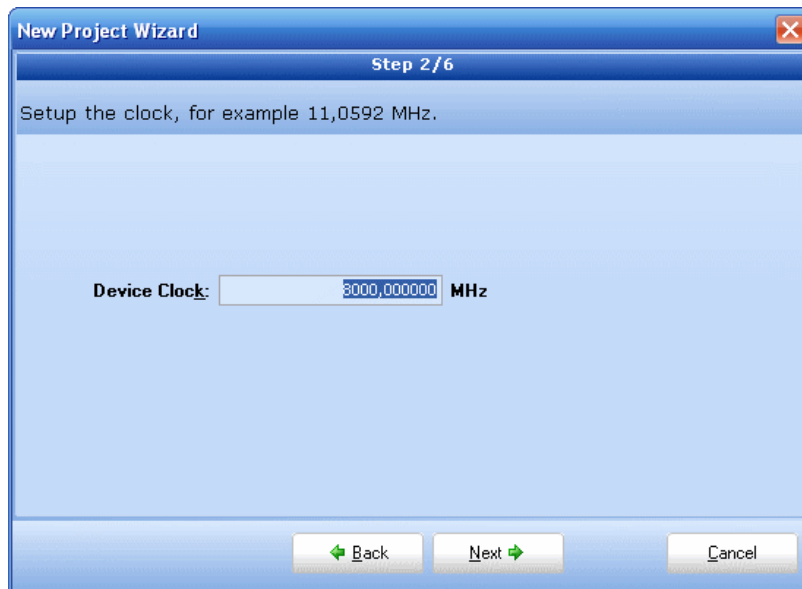

Step Four - Select the desired memory model.

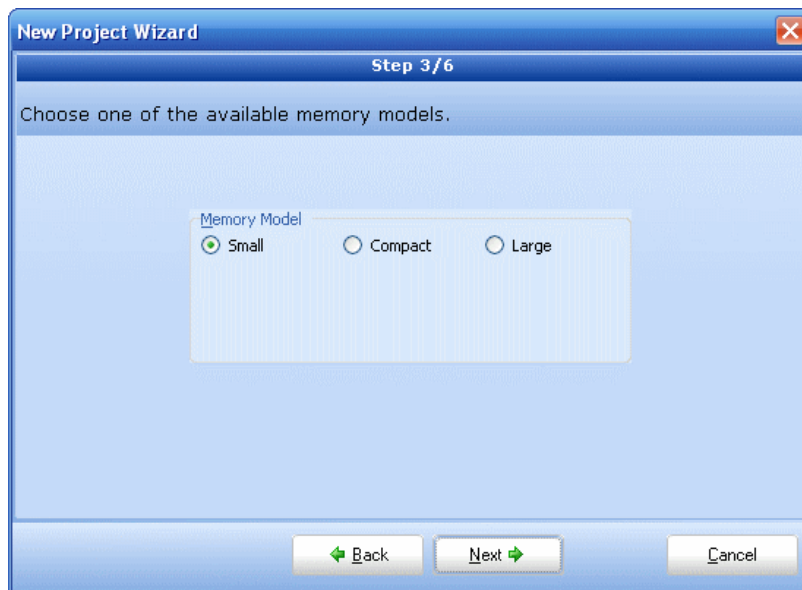

Step Five - Specify the location where your project will be saved.

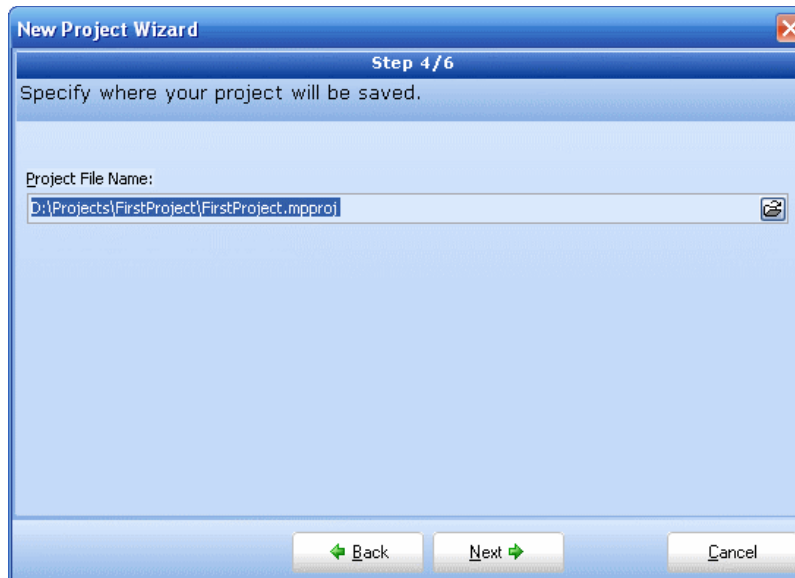

Step Six - Add project file to the project if they are available at this point. You can always add project files later using Project Manager

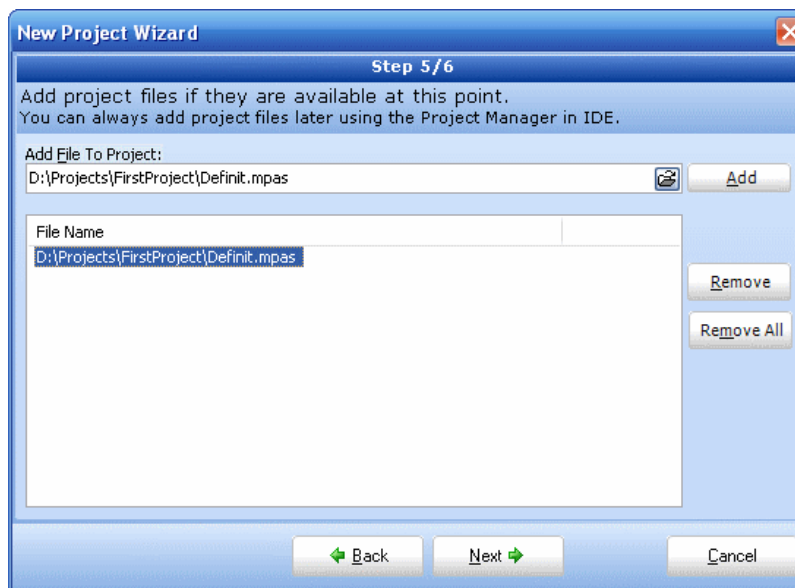

Open Project

You can open existing project by doing the following: go to **Project > Open** from drop-down menu (shortcut Shift+Ctrl+O), and find the location that contains your project file (extension `.mproj`). Select project file and then click on Open button. **If you do not open project file (for instance source file `.mpas` only) you will not be able to compile or program desired code.**

Related topics: Project Manager, Project Settings, Memory Model



CUSTOMIZING PROJECTS

Edit Project

You can change basic project settings in the Project Settings window. You can change chip, oscillator frequency, and memory model. Any change in the Project Setting Window affects currently active project only, so in case more than one project is open, you have to ensure that exactly the desired project is set as active one in the Project Manager.

Managing Project Group

mikroPascal for 8051 IDE provides convenient option which enables several projects to be open simultaneously. If you have several projects being connected in some way, you can create a project group.

The project group may be saved by clicking the Save Project Group Icon  from the Project Manager window. The project group may be reopened by clicking the Open Project Group Icon . All relevant data about the project group is stored in the project group file (extension `.mpg`)

Add/Remove Files from Project

The project can contain the following file types:

- `.mpas` source files
- `.mcl` binary files
- `.pld` project level defines files (future upgrade)
- image files
- `.hex`, `.asm` and `.lst` files, see output files. These files can not be added or removed from project.
- other files

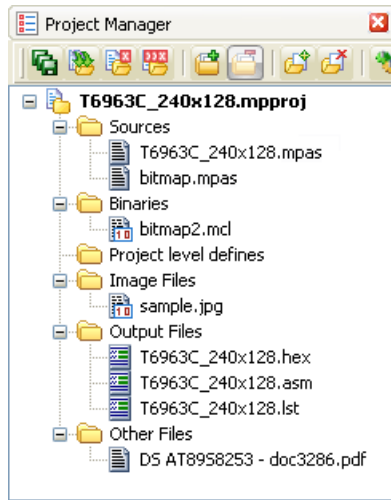

The list of relevant source files is stored in the project file (extension `.mpproj`).

To add source file to the project, click the Add File to Project Icon . Each added source file must be self-contained, i.e. it must have all necessary definitions after preprocessing.

To remove file(s) from the project, click the Remove File from Project Icon .

See File Inclusion for more information.

Related topics: Project Manager, Project Settings, Memory Model



SOURCE FILES

Source files containing Pascal code should have the extension `.mpas`. The list of source files relevant to the application is stored in project file with extension `.mpproj`, along with other project information. You can compile source files only if they are part of the project.

Managing Source Files

Creating new source file

To create a new source file, do the following:

1. Select **File** > **New Unit** from the drop-down menu, or press Ctrl+N, or click the New File Icon  from the File Toolbar.
2. A new tab will be opened. This is a new source file. Select **File** > **Save** from the drop-down menu, or press Ctrl+S, or click the Save File Icon  from the File Toolbar and name it as you want.

If you use the New Project Wizard, an empty source file, named after the project with extension `.mpas`, will be created automatically. The mikroPascal 8051 does not require you to have a source file named the same as the project, it's just a matter of convenience.

Opening an existing file

1. Select **File** > **Open** from the drop-down menu, or press Ctrl+O, or click the Open File Icon  from the File Toolbar. In Open Dialog browse to the location of the file that you want to open, select it and click the Open button.
2. The selected file is displayed in its own tab. If the selected file is already open, its current Editor tab will become active.

Printing an open file

1. Make sure that the window containing the file that you want to print is the active window.
2. Select **File** > **Print** from the drop-down menu, or press Ctrl+P.
3. In the Print Preview Window, set a desired layout of the document and click the OK button. The file will be printed on the selected printer.

Saving file

1. Make sure that the window containing the file that you want to save is the active window.
2. Select **File** › **Save** from the drop-down menu, or press Ctrl+S, or click the Save File Icon  from the File Toolbar.

Saving file under a different name

1. Make sure that the window containing the file that you want to save is the active window.
2. Select **File** › **Save As** from the drop-down menu. The New File Name dialog will be displayed.
3. In the dialog, browse to the folder where you want to save the file.
4. In the File Name field, modify the name of the file you want to save.
5. Click the Save button.

Closing file

1. Make sure that the tab containing the file that you want to close is the active tab.
2. Select **File** › **Close** from the drop-down menu, or right click the tab of the file that you want to close and select **Close** option from the context menu.
3. If the file has been changed since it was last saved, you will be prompted to save your changes.

Related topics:File Menu, File Toolbar, Project Manager, Project Settings,

CLEAN PROJECT FOLDER



Clean Project Folder

This menu gives you option to choose which files from your current project you want to delete.

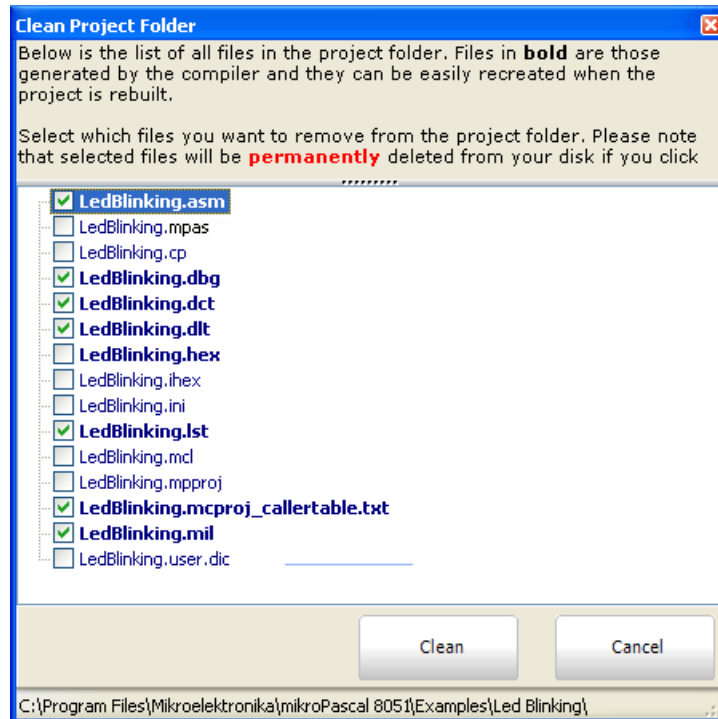
Files marked in **bold** can be easily recreated by building a project. Other files should be marked for deletion only with a great care, because IDE cannot recover them.



COMPILATION

When you have created the project and written the source code, it's time to compile it. Select **Project** > **Build** from the drop-down menu, or click the Build Icon  from the Project Toolbar. If more more than one project is open you can compile all open projects by selecting **Project** > **Build All** from the drop-down menu, or click the Build All Icon  from the Project Toolbar.

Progress bar will appear to inform you about the status of compiling. If there are some errors, you will be notified in the Error Window. If no errors are encountered, the *mikroPascal for 8051* will generate output files.

Output Files

Upon successful compilation, the *mikroPascal for 8051* will generate output files in the project folder (folder which contains the project file `.mpproj`). Output files are summarized in the table below:

Format	Description	File Type
Intel HEX	Intel style hex records. Use this file to program 8051 MCU.	<code>.hex</code>
Binary	mikro Compiled Library. Binary distribution of application that can be included in other projects.	<code>.mcl</code>
List File	Overview of 8051 memory allotment: instruction addresses, registers, routines and labels.	<code>.lst</code>
Assembler File	Human readable assembly with symbolic names, extracted from the List File.	<code>.asm</code>

Assembly View

After compiling the program in the *mikroPascal for 8051*, you can click the View Assembly icon  or select **Project** > **View Assembly** from the drop-down menu to review the generated assembly code (`.asm` file) in a new tab window. Assembly is human-readable with symbolic names.

Related topics:Project Menu, Project Toolbar, Error Window, Project Manager, Project Settings

ERROR MESSAGES

Compiler Error Messages:

- "%S" is not valid identifier.
- Unknown type "%S".
- Identifier "%S" was not declared.
- Syntax error: Expected "%S" but "%S" found.
- Argument is out of range "%S".
- Syntax error in additive expression.
- File "%S" not found.
- Invalid command "%S".
- Not enough parameters.
- Too many parameters.
- Too many characters.
- Actual and formal parameters must be identical.
- Invalid ASM instruction: "%S".
- Identifier "%S" has been already declared in "%S".
- Syntax error in multiplicative expression.
- Definition file for "%S" is corrupted.
- ORG directive is currently supported for interrupts only.
- Not enough ROM.
- Not enough RAM.
- External procedure "%S" used in "%S" was not found.
- Internal error: "%S".
- Unit cannot recursively use itself.
- "%S" cannot be used out of loop.
- Supplied and formal parameters do not match ("%S" to "%S").
- Constant cannot be assigned to.
- Constant array must be declared as global.
- Incompatible types ("%S" to "%S").
- Too many characters ("%S").
- Soft_Uart cannot be initialized with selected baud rate/device clock.
- Main label cannot be used in modules.
- Break/Continue cannot be used out of loop.
- Preprocessor Error: "%S".
- Expression is too complicated.
- Duplicated label "%S".
- Complex type cannot be declared here.
- Record is empty.
- Unknown type "%S".
- File not found "%S".
- Constant argument cannot be passed by reference.
- Pointer argument cannot be passed by reference.

- Operator "%s" not applicable to these operands "%s".
- Exit cannot be called from the main block.
- Array parameter must be passed by reference.
- Error occurred while compiling "%s".
- Recursive types are not allowed.
- Adding strings is not allowed, use "strcat" procedure instead.
- Cannot declare pointer to array, use pointer to structure which has array field.
- Return value of the function "%s" is not defined.
- Assignment to for loop variable is not allowed.
- "%s" is allowed only in the main program.
- Start address of "%s" has already been defined.
- Simple constant cannot have a fixed address.
- Invalid date/time format.
- Invalid operator "%s".
- File "%s" is not accessible.
- Forward routine "%s" is missing implementation.
- ";" is not allowed before "else".
- Not enough elements: expected "%s", but "%s" elements found.
- Too many elements: expected "%s" elements.
- "external" is allowed for global declarations only.
- Integer const expected.
- Recursion in definition.
- Array corrupted.
- Arguments cannot have explicit memory specifier.
- Bad storage class.
- Pointer to function required.
- Function required.
- Pointer required.
- Illegal pointer conversion to double.
- Integer type needed.
- Members can not have memory specifier.
- Members can not be of bit or sbit type.
- Too many initializers.
- Too many initializers of subaggregate.
- Already used [%s] .
- Address must be greater than 0.
- [%s] Identifier redefined.
- User abort.
- Expression must be greater than 0.
- Invalid declarator expected '(' or identifier.
- Typdef name redefined: [%s] .
- Declarator error.
- Specifier/qualifier list expected.
- [%s] already used.

- ILevel can be used only with interrupt service routines.
- ';' expected but [%s] found.
- Expected '['.
- [%s] Identifier redefined.
- '(' expected but [%s] found.
- ')' expected but [%s] found.
- 'case' out of switch.
- ':' expected but [%s] found.
- 'default' label out of switch.
- Switch expression must evaluate to integral type.
- While expected but [%s] found.
- 'continue' outside of loop.
- Unreachable code.
- Label redefined.
- Too many chars.
- Unresolved type.
- Arrays of objects containing zero-size arrays are illegal.
- Invalid enumerator.
- ILevel can be used only with interrupt service routines.
- ILevel value must be integral constant.
- ILevel out of range [0..4].
- ')' expected but [%s] found.
- '(' expected but [%s] found.
- 'break' outside of loop or switch.
- Empty char.
- Nonexistent field [%s] .
- Illegal char representation: [%s] .
- Initializer syntax error: multidimension array missing subscript.
- Too many initializers of subaggregate.
- At least one Search Path must be specified.
- Not enough RAM for call stack.
- Parameter [%s] must not be of bit or sbit type.
- Function must not have return value of bit or sbit type.
- Redefinition of [%s] already defined in [%s] .
- Main function is not defined.
- System routine not found for initialization of: [%s] .
- Bad aggregate definition [%s] .
- Unresolved extern [%s] .
- Bad function absolute address [%s] .
- Not enough RAM [%s] .
- Compilation Started.
- Compiled Successfully.
- Finished (with errors): 01 Mar 2008, 14:22:26
- Project Linked Successfully.
- All files Preprocessed in [%s] ms.
- All files Compiled in [%s] ms.
- Linked in [%s] ms.
- Project [%s] completed: [%s] ms.

Linker Error Messages:

- Linker error: "%s" "%s".
- Warning: Variable "%s" is not initialized.
- Warning: Return value of the function "%s" is not defined.
- Hint: Constant "%s" has been declared, but not used.
- Warning: Identifier "%s" overrides declaration in unit "%s".
- Constant "%s" was not found.
- Address of the routine has already been defined.
- Duplicated label "%s".
- File "%s" not found.

Hint Messages:

- Hint: Variable "%s" has been declared, but not used.
- Warning: Variable "%s" is not initialized.
- Warning: Return value of the function "%s" is not defined.
- Hint: Constant "%s" has been declared, but not used.
- Warning: Identifier "%s" overrides declaration in unit "%s".
- Warning: Generated baud rate is "%s" bps (error = "%s" percent).
- Warning: Result size may exceed destination array size.
- Warning: Infinite loop.
- Warning: Implicit typecast performed from "%s" to "%s".
- Hint: Unit "%s" has been recompiled.
- Hint: Variable "%s" has been eliminated by optimizer.
- Warning: Implicit typecast of integral value to pointer
- Warning: Library "%s" was not found in search path.
- Warning: Interrupt context saving has been turned off.
- Hint: Compiling unit "%s".

SOFTWARE SIMULATOR OVERVIEW

The Source-level Software Simulator is an integral component of the *mikroPascal for 8051* environment. It is designed to simulate operations of the 8051 MCUs and assist the users in debugging Pascal code written for these devices.

After you have successfully compiled your project, you can run the Software Simulator by selecting **Run > Start Debugger** from the drop-down menu, or by clicking the Start Debugger Icon  from the Debugger Toolbar. Starting the Software Simulator makes more options available: Step Into, Step Over, Step Out, Run to Cursor, etc. Line that is to be executed is color highlighted (blue by default).



Note: The Software Simulator simulates the program flow and execution of instruction lines, but it cannot fully emulate 8051 device behavior, i.e. it doesn't update timers, interrupt flags, etc.

Watch Window

The Software Simulator Watch Window is the main Software Simulator window which allows you to monitor program items while simulating your program. To show the Watch Window, select **View > Debug Windows > Watch** from the drop-down menu.

The Watch Window displays variables and registers of the MCU, along with their addresses and values.

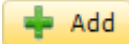
There are two ways of adding variable/register to the watch list:

- by its real name (variable's name in "Pascal" code). Just select desired variable/register from **Select variable from list** drop-down menu and click the Add Button  .
- by its name ID (assembly variable name). Simply type name ID of the variable/register you want to display into **Search the variable by assembly name** box and click the Add Button  .

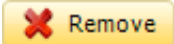
Variables can also be removed from the Watch window, just select the variable that you want to remove and then click the Remove Button  .

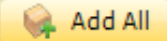
Add All Button  adds all variables.

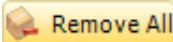
Remove All Button  removes all variables.

You can also expand/collapse complex variables, i.e. struct type variables, strings...

Values are updated as you go through the simulation. Recently changed items are colored red.

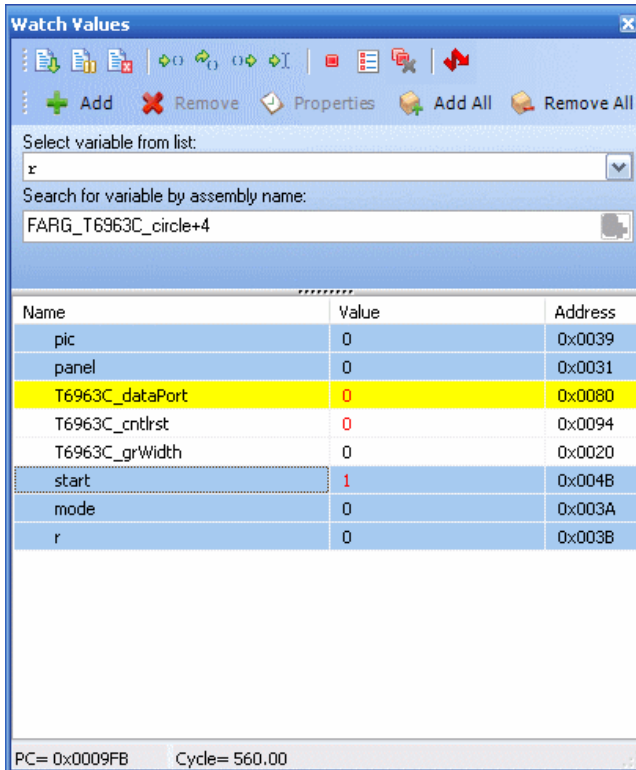

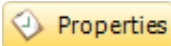
Double clicking a variable or clicking the Properties Button  opens the Edit Value window in which you can assign a new value to the selected variable/register. Also, you can choose the format of variable/register representation between decimal, hexadecimal, binary, float or character. All representations except float are unsigned by default. For signed representation click the check box next to the **Signed** label.

An item's value can be also changed by double clicking item's value field and typing the new value directly.

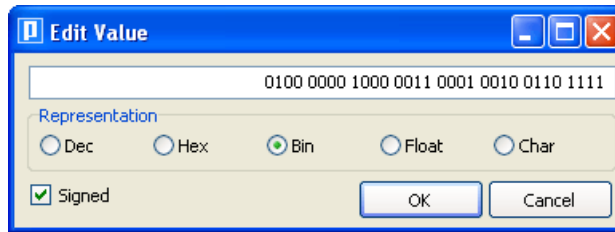

Stopwatch Window

The Software Simulator Stopwatch Window is available from the drop-down menu, **View > Debug Windows > Stopwatch**.

The Stopwatch Window displays a current count of cycles/time since the last Software Simulator action. Stopwatch measures the execution time (number of cycles) from the moment Software Simulator has started and can be reset at any time. Delta represents the number of cycles between the lines where Software Simulator action has started and ended.

Note: The user can change the clock in the Stopwatch Window, which will recalculate values for the latest specified frequency. Changing the clock in the Stopwatch Window does not affect actual project settings – it only provides a simulation.

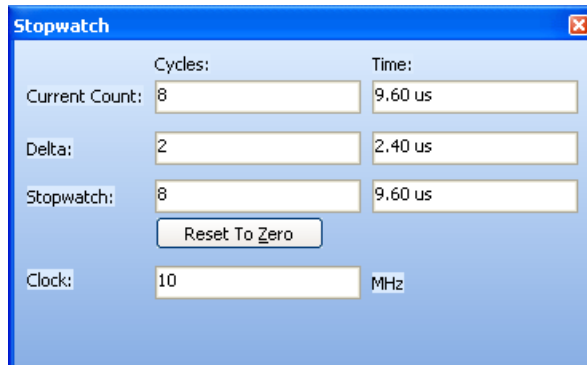









RAM Window

The Software Simulator RAM Window is available from the drop-down menu, **View** › **Debug Windows** › **RAM**.

The RAM Window displays a map of MCU's RAM, with recently changed items colored red. You can change value of any field by double-clicking it.

	00	01	02	03	04	05	06	07	08	09	0A	0B	0C	0D	0E	0F	ASCII
0000	BC	00	00	00	00	00	00	00	00	00	00	00	00	00	00	00	...
0010	00	00	00	00	00	00	00	00	00	00	00	00	00	00	00	00
0020	00	00	00	00	00	00	00	00	00	00	00	00	00	00	00	00
0030	00	00	00	00	00	00	00	00	00	00	00	00	00	00	00	00
0040	00	00	00	00	00	00	00	00	00	00	00	01	00	00	00	00	...
0050	00	00	00	00	00	00	00	00	00	00	00	00	00	00	00	00
0060	00	00	00	00	00	00	00	00	00	00	00	00	00	00	00	00
0070	00	00	00	00	00	00	00	00	00	00	00	00	00	00	00	00
0080	00	BC	55	0E	00	00	00	00	00	00	00	00	00	00	00	00	...
0090	00	00	00	00	00	00	00	00	00	00	00	00	00	00	00	00
00A0	00	00	00	00	00	00	00	00	00	00	00	00	00	00	00	00
00B0	00	00	00	00	00	00	00	00	00	00	00	00	00	00	00	00
00C0	00	00	00	00	00	00	00	00	00	00	00	00	00	00	00	00

SOFTWARE SIMULATOR OPTIONS

Name	Description	Function Key	Toolbar Icon
Start Debugger	Start Software Simulator.	[F9]	
Run/Pause Debugger	Run or pause Software Simulator.	[F6]	
Stop Debugger	Stop Software Simulator.	[Ctrl+F2]	
Toggle Breakpoints	Toggle breakpoint at the current cursor position. To view all breakpoints, select Run > View Breakpoints from the drop-down menu. Double clicking an item in the Breakpoints Window List locates the breakpoint.	[F5]	
Run to cursor	Execute all instructions between the current instruction and cursor position.	[F4]	
Step Into	Execute the current Pascal (single or multi-cycle) instruction, then halt. If the instruction is a routine call, enter the routine and halt at the first instruction following the call.	[F7]	
Step Over	Execute the current Pascal (single or multi-cycle) instruction, then halt.	[F8]	
Step Out	Execute all remaining instructions in the current routine, return and then halt.	[Ctrl+F8]	

Related topics: Run Menu, Debug Toolbar

CREATING NEW LIBRARY

mikroPascal for 8051 allows you to create your own libraries. In order to create a library in *mikroPascal for 8051* follow the steps bellow:

1. Create a new Pascal source file, see Managing Source Files
2. Save the file in the compiler's Uses folder:
`DriveName:\Program Files\Mikroelektronika\mikroPascal 8051\Uses__Lib_Example.mpas`
3. Write a code for your library and save it.
4. Add `__Lib_Example.mpas` file in some project, see Project Manager. Recompile the project.
5. Compiled file `__Lib_Example.mcl` should appear in `...\mikroPascal 8051\Uses\` folder.
6. Open the definition file for the MCU that you want to use. This file is placed in the compiler's Defs folder:
`DriveName:\Program Files\Mikroelektronika\mikroPascal 8051\Defs\` and it is named `MCU_NAME.mlk`, for example `AT89S8253.mlk`
7. Add the `Library_Alias` and `Library_Name` at the end of the definition file, for example `#pragma SetLib([Example_Library, __Lib_Example])`
8. Add Library to mlk file for each MCU that you want to use with your library.
9. Click Refresh button in Library Manager

Multiple Library Versions

Library Alias represents unique name that is linked to corresponding Library `.mcl` file. For example UART library for AT89S8253 is different from UART library for AT89S4051 MCU. Therefore, two different UART Library versions were made, see `mlk` files for these two MCUs. Note that these two libraries have the same Library Alias (UART) in both `mlk` files. This approach enables you to have identical representation of UART library for both MCUs in Library Manager.

Related topics: Library Manager, Project Manager, Managing Source Files

CHAPTER

3

mikroPascal for 8051 **Specifics**

The following topics cover the specifics of mikroPascal compiler:

- Pascal Standard Issues
- Predefined Globals and Constants
- Accessing Individual Bits
- Interrupts
- 8051 Pointers
- Linker Directives
- Built-in Routines
- Code Optimization

PASCAL STANDARD ISSUES

Divergence from the Pascal Standard

- Function recursion is not supported because of no easily-usable stack and limited memory 8051 Specific

Pascal Language Extensions

mikroPascal for 8051 has additional set of keywords that do not belong to the standard Pascal language keywords:

- `code`
- `data`
- `idata`
- `bdata`
- `xdata`
- `pdata`
- `small`
- `compact`
- `large`
- `at`
- `sbit`
- `bit`
- `sfr`
- `ilevel`

Related topics: Keywords, 8051 Specific

PREDEFINED GLOBALS AND CONSTANTS

To facilitate programming of 8051 compliant MCUs, the *mikroPascal for 8051* implements a number of predefined globals and constants.

All 8051 **SFR registers** are implicitly declared as global variables of volatile word. These identifiers have an external linkage, and are visible in the entire project. When creating a project, the *mikroPascal for 8051* will include an appropriate (*.mpas) file from defs folder, containing declarations of available **SFR registers** and constants.

```
P0 := 1;
```

Math constants

In addition, several commonly used math constants are predefined in *mikroPascal for 8051*:

```
PI          = 3.1415926  
PI_HALF    = 1.5707963  
TWO_PI     = 6.2831853  
E          = 2.7182818
```

For a complete set of predefined globals and constants, look for “Defs” in the *mikroPascal for 8051* installation folder, or probe the Code Assistant for specific letters (Ctrl+Space in the Code Editor).

ACCESSING INDIVIDUAL BITS

The *mikroPascal for 8051* allows you to access individual bits of 8-bit variables. It also supports `sbit` and `bit` data types

Accessing Individual Bits Of Variables

Simply use the direct member selector (`.`) with a variable, preceded with 'B' and followed by one of identifiers `0`, `1`, ..., `15` with `15` being the most significant bit.

There is no need of any special declarations. This kind of selective access is an intrinsic feature of *mikroPascal for 8051* and can be used anywhere in the code. Identifiers `0-15` are not case sensitive and have a specific namespace. You may override them with your own members `0-15` within any given structure.

If you are familiar with a particular MCU, you can also access bits by name:

```
// Clear bit 3 on Port0
P0.3 := 0;
```

See Predefined Globals and Constants for more information on register/bit names.

`sbit` type

The mikroPascal Compiler have `sbit` data type which provides access to bit-addressable SFRs. For example:

```
var LEDA : sbit at P0.B0;
var name : sbit at sfr-name.B<bit-position>;
```

The previously declared SFR (`sfr-name`) is the base address for the `sbit`. It must be evenly divisible by 8. The bit-position (which must be a number from 0-7) follows the dot symbol (`.`) and specifies the bit position to access. For example:

```
var OV : sbit at PSW.B2;
var CY : sbit at PSW.B7;
```

bit type

The mikroPascal Compiler provides a `bit` data type that may be used for variable declarations. It can not be used for argument lists, and function-return values.

```
var bf : bit;    // bit variable
```

All bit variables are stored in a bit addressable portion 0x20-0x2F segment located in the internal memory area of the 8051. Because this area is only 16 bytes long, a maximum of 128 bit variables may be declared within any one scope.

There are no pointers to bit variables:

```
var ptr : ^bit;    // invalid
```

An array of type bit is not valid:

```
var arr[5] : bit;    // invalid
```

Bit variables can not be initialized nor they can be members of records.

Related topics: Predefined globals and constants

INTERRUPTS

8051 derivates acknowledges an interrupt request by executing a hardware generated LCALL to the appropriate servicing routine ISRs. ISRs are organized in IVT. ISR is defined as a standard function but with the org directive afterwards which connects the function with specific interrupt vector. For example org 0x000B is IVT address of Timer 0 Overflow interrupt source of the AT89S8253.

For more information on interrupts and IVT refer to the specific data sheet.

Function Calls from Interrupt

Calling functions from within the interrupt routine is allowed. The compiler takes care about the registers being used, both in "interrupt" and in "main" thread, and performs "smart" context-switching between them two, saving only the registers that have been used in both threads. It is not recommended to use function call from interrupt. In case of doing that take care of stack depth.

Interrupt Priority Level

8051 MCUs has possibilty to assign different priority level trough setting appropriate values to coresponding SFRs. You should also assign ISR same priority level by ilevel keyword followed by interrupt priority number.

Available interrupt priority levels are: 0 (default), 1, 2 and 3.

```
procedure Timer0ISR(); org 0x000B; ilevel 2;
begin
    //set Timer0ISR to be ISR for Timer 0 Overflow priority level 2.
end;
```

Related topics: Pascal standard issues

LINKER DIRECTIVES

mikroPascal for 8051 uses internal algorithm to distribute objects within memory. If you need to have a variable or a routine at the specific predefined address, use the linker directives `absolute` and `org`.

Note: You must specify an even address when using the linker directives.

Directive `absolute`

Directive `absolute` specifies the starting address in RAM for a variable. If the variable spans more than 1 word (16-bit), the higher words will be stored at the consecutive locations.

Directive `absolute` is appended to the declaration of a variable:

```
var x : word; absolute $32;
// Variable x will occupy 1 word (16 bits) at address $32

    y : longint; absolute $34;
// Variable y will occupy 2 words at addresses $34 and $36
```

Be careful when using the `absolute` directive because you may overlap two variables by accident. For example:

```
var i : word; absolute $42;
// Variable i will occupy 1 word at address $42;

    jj : longint; absolute $40;
// Variable will occupy 2 words at $40 and $42; thus,
// changing i changes jj at the same time and vice versa
```

Note: You must specify an even address when using the `absolute` directive.

Directive `org`

Directive `org` specifies the starting address of a routine in ROM. It is appended to the declaration of a routine. For example:

```
procedure proc(par : byte); org $200;
begin
// Procedure will start at address $200;
...
end;
```

`org` directive can be used with `main` routine too. For example:

```
program Led_Blinking;

procedure some_proc();
begin
...
end;

org 0x800;           // main procedure starts at 0x800
begin
  ADPCFG := $FFFF;
  TRISB := $0000;

  while TRUE do
    begin
      LATB := $0000;
      Delay_ms(500);
      LATB := $FFFF;
      Delay_ms(500);
    end;
end.
```

Note: You must specify an even address when using the `org` directive.

BUILT-IN ROUTINES

The *mikroPascal for 8051* compiler provides a set of useful built-in utility functions.

The `Delay_us` and `Delay_ms` routines are implemented as “inline”; i.e. code is generated in the place of a call, so the call doesn’t count against the nested call limit.

The `Vdelay_ms`, `Delay_Cyc` and `Get_Fosc_kHz` are actual Pascal routines. Their sources can be found in `Delays.mpas` file located in the `uses` folder of the compiler.

- Lo
- Hi
- Higher
- Highest

- Inc
- Dec

- Delay_us
- Delay_ms
- Vdelay_ms
- Delay_Cyc

- Clock_Khz
- Clock_Mhz

- SetFuncCall
- Uart_Init

Lo

Prototype	<code>function Lo(number: longint): byte;</code>
Returns	Lowest 8 bits (byte) of number, bits 7..0.
Description	Function returns the lowest byte of <code>number</code> . Function does not interpret bit patterns of <code>number</code> – it merely returns 8 bits as found in register. This is an “inline” routine; code is generated in the place of the call, so the call doesn’t count against the nested call limit.
Requires	Arguments must be variable of scalar type (i.e. Arithmetic Types and Pointers).
Example	<pre>d := 0x1AC30F4; tmp := Lo(d); // Equals 0xF4</pre>

Hi

Prototype	<code>function Hi(number: longint): byte;</code>
Returns	Returns next to the lowest byte of number, bits 8..15.
Description	Function returns next to the lowest byte of <code>number</code> . Function does not interpret bit patterns of <code>number</code> – it merely returns 8 bits as found in register. This is an “inline” routine; code is generated in the place of the call, so the call doesn’t count against the nested call limit.
Requires	Arguments must be variable of scalar type (i.e. Arithmetic Types and Pointers).
Example	<pre>d := 0x1AC30F4; tmp := Hi(d); // Equals 0x30</pre>

Higher

Prototype	<code>function Higher(number: longint): byte;</code>
Returns	Returns next to the highest byte of <code>number</code> , bits 16..23.
Description	Function returns next to the highest byte of <code>number</code> . Function does not interpret bit patterns of <code>number</code> – it merely returns 8 bits as found in register. This is an “inline” routine; code is generated in the place of the call, so the call doesn’t count against the nested call limit.
Requires	Arguments must be variable of scalar type (i.e. Arithmetic Types and Pointers).
Example	<pre>d := 0x1AC30F4; tmp := Higher(d); // Equals 0xAC</pre>

Highest

Prototype	<code>function Highest(number: longint): byte;</code>
Returns	Returns the highest byte of <code>number</code> , bits 24..31.
Description	Function returns the highest byte of <code>number</code> . Function does not interpret bit patterns of <code>number</code> – it merely returns 8 bits as found in register. This is an “inline” routine; code is generated in the place of the call, so the call doesn’t count against the nested call limit.
Requires	Arguments must be variable of scalar type (i.e. Arithmetic Types and Pointers).
Example	<pre>d := 0x1AC30F4; tmp := Highest(d); // Equals 0x01</pre>

Inc

Prototype	<code>procedure Inc(var par : longint);</code>
Returns	Nothing.
Description	Increases parameter <code>par</code> by 1.
Requires	Nothing.
Example	<pre>p := 4; Inc(p); // p is now 5</pre>

Dec

Prototype	<code>procedure Dec(var par : longint);</code>
Returns	Nothing.
Description	Decreases parameter <code>par</code> by 1.
Requires	Nothing.
Example	<pre>p := 4; Dec(p); // p is now 3</pre>

Delay_us

Prototype	<code>procedure Delay_us(time_in_us: const longword);</code>
Returns	Nothing.
Description	Creates a software delay in duration of <code>time_in_us</code> microseconds (a constant). Range of applicable constants depends on the oscillator frequency. This is an “inline” routine; code is generated in the place of the call, so the call doesn’t count against the nested call limit.
Requires	Nothing.
Example	<code>Delay_us(1000); /* One millisecond pause */</code>

Delay_ms

Prototype	<code>procedure Delay_ms(time_in_ms: const longword);</code>
Returns	Nothing.
Description	Creates a software delay in duration of <code>time_in_ms</code> milliseconds (a constant). Range of applicable constants depends on the oscillator frequency. This is an “inline” routine; code is generated in the place of the call, so the call doesn’t count against the nested call limit.
Requires	Nothing.
Example	<code>Delay_ms(1000); /* One second pause */</code>

Vdelay_ms

Prototype	<code>procedure Vdelay_ms(time_in_ms: word);</code>
Returns	Nothing.
Description	Creates a software delay in duration of <code>time_in_ms</code> milliseconds (a variable). Generated delay is not as precise as the delay created by <code>Delay_ms</code> . Note that <code>Vdelay_ms</code> is library function rather than a built-in routine; it is presented in this topic for the sake of convenience.
Requires	Nothing.
Example	<code>pause := 1000; // ... Vdelay_ms(pause); // ~ one second pause</code>

Delay_Cyc

Prototype	<code>procedure Delay_Cyc(Cycles_div_by_10: byte);</code>
Returns	Nothing.
Description	Creates a delay based on MCU clock. Delay lasts for 10 times the input parameter in MCU cycles. Note that <code>Delay_Cyc</code> is library function rather than a built-in routine; it is presented in this topic for the sake of convenience. There are limitations for <code>Cycles_div_by_10</code> value. Value <code>Cycles_div_by_10</code> must be between 2 and 257.
Requires	Nothing.
Example	<code>Delay_Cyc(10); /* Hundred MCU cycles pause */</code>

Clock_KHz

Prototype	<code>function Clock_KHz(): word;</code>
Returns	Device clock in KHz, rounded to the nearest integer.
Description	Function returns device clock in KHz, rounded to the nearest integer. This is an “inline” routine; code is generated in the place of the call, so the call doesn’t count against the nested call limit.
Requires	Nothing.
Example	<code>clk := Clock_kHz();</code>

Clock_MHz

Prototype	<code>function Clock_MHz(): byte;</code>
Returns	Device clock in MHz, rounded to the nearest integer.
Description	Function returns device clock in MHz, rounded to the nearest integer. This is an “inline” routine; code is generated in the place of the call, so the call doesn’t count against the nested call limit.
Requires	Nothing.
Example	<code>clk := Clock_MHz();</code>

SetFuncCall

Prototype	<code>procedure SetFuncCall(FuncName: string);</code>
Returns	Nothing.
Description	<p>Function informs the linker about a specific routine being called. SetFuncCall has to be called in a routine which accesses another routine via a pointer.</p> <p>Function prepares the caller tree, and informs linker about the procedure usage, making it possible to link the called routine.</p>
Requires	Nothing.
Example	<pre> procedure first(p, q: byte); begin ... SetFuncCall(second); // let linker know that we will call the routine 'second' ... end </pre>

Uart_Init

Prototype	<code>procedure Uart_Init(baud_rate: longword);</code>
Returns	Nothing.
Description	<p>Configures and initializes the UART module.</p> <p>The internal UART module module is set to:</p> <ul style="list-style-type: none"> - 8-bit data, no parity - 1 STOP bit - disabled automatic address recognition - timer1 as baudrate source (mod2 = autoreload 8bit timer) <p>Parameters :</p> <ul style="list-style-type: none"> - <code>baud_rate</code>: requested baud rate <p>Refer to the device data sheet for baud rates allowed for specific Fosc.</p>
Requires	MCU with the UART module and TIMER1 to be used as baudrate source.
Example	<pre> // Initialize hardware UART and establish communication at 2400 bps Uart_Init(2400); </pre>

CODE OPTIMIZATION

Optimizer has been added to extend the compiler usability, cut down the amount of code generated and speed-up its execution. The main features are:

Constant folding

All expressions that can be evaluated in the compile time (i.e. are constant) are being replaced by their results. (3 + 5 -> 8);

Constant propagation

When a constant value is being assigned to a certain variable, the compiler recognizes this and replaces the use of the variable by constant in the code that follows, as long as the value of a variable remains unchanged.

Copy propagation

The compiler recognizes that two variables have the same value and eliminates one of them further in the code.

Value numbering

The compiler "recognizes" if two expressions yield the same result and can therefore eliminate the entire computation for one of them.

"Dead code" elimination

The code snippets that are not being used elsewhere in the programme do not affect the final result of the application. They are automatically removed.

Stack allocation

Temporary registers ("Stacks") are being used more rationally, allowing VERY complex expressions to be evaluated with a minimum stack consumption.

Local vars optimization

No local variables are being used if their result does not affect some of the global or volatile variables.

Better code generation and local optimization

Code generation is more consistent and more attention is paid to implement specific solutions for the code "building bricks" that further reduce output code size.

CHAPTER

4

8051 Specifics

Types Efficiency

First of all, you should know that 8051 ALU, which performs arithmetic operations, is optimized for working with bytes. Although mikroPascal is capable of handling very complex data types, 8051 may choke on them, especially if you are working on some of the older models. This can dramatically increase the time needed for performing even simple operations. Universal advice is to use the smallest possible type in every situation. It applies to all programming in general, and doubly so with microcontrollers. Types efficiency is determined by the part of RAM memory that is used to store a variable/constant. See the example.

Nested Calls Limitations

There are no Nested Calls Limitations, except by RAM size. A Nested call represents a function call to another function within the function body. With each function call, the stack increases for the size of the returned address. Number of nested calls is equal to the capacity of RAM which is left out after allocation of all variables.

Note: There are many different types of derivatives, so it is necessary to be familiar with characteristics and special features of the microcontroller in you are using.

8051 MEMORY ORGANIZATION

The 8051 microcontroller's memory is divided into Program Memory and Data Memory. Program Memory (ROM) is used for permanent saving program being executed, while Data Memory (RAM) is used for temporarily storing and keeping intermediate results and variables.

Program Memory (ROM)

Program Memory (ROM) is used for permanent saving program (CODE) being executed. The memory is read only. Depending on the settings made in compiler, program memory may also used to store a constant variables. The 8051 executes programs stored in program memory only. `code` memory type specifier is used to refer to program memory.

8051 memory organization allows external program memory to be added. How does the microcontroller handle external memory depends on the pin EA logical state.

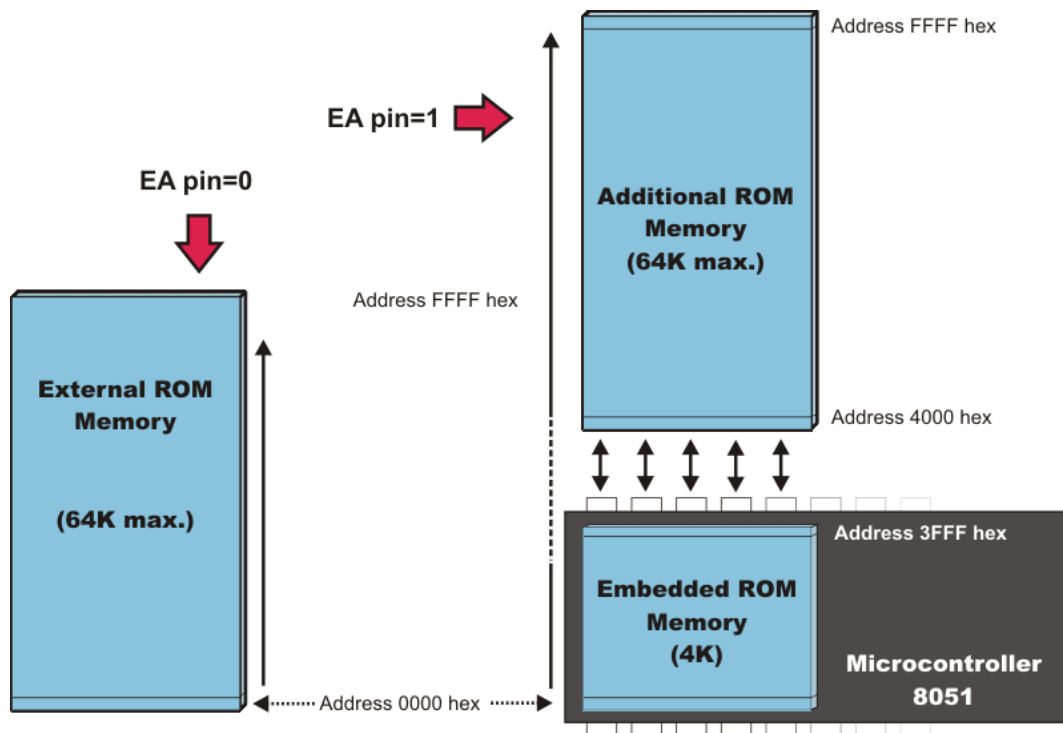

Internal Data Memory

Up to 256 bytes of internal data memory are available depending on the 8051 derivative. Locations available to the user occupy addressing space from 0 to 7Fh, i.e. first 128 registers and this part of RAM is divided in several blocks. The first 128 bytes of internal data memory are both directly and indirectly addressable. The upper 128 bytes of data memory (from 0x80 to 0xFF) can be addressed only indirectly.

Since internal data memory is used for CALL stack also and there is only 256 bytes splitted over few different memory areas fine utilizing of this memory is crucial for fast and compact code. See types efficiency also.

Memory block in the range of 20h to 2Fh is bit-addressable, which means that each bit being there has its own address from 0 to 7Fh. Since there are 16 such registers, this block contains in total of 128 bits with separate addresses (Bit 0 of byte 20h has the bit address 0, and bit 7 of byte 2Fh has the bit address 7Fh).

Three memory type specifiers can be used to refer to the internal data memory: `data`, `idata`, and `bdata`.

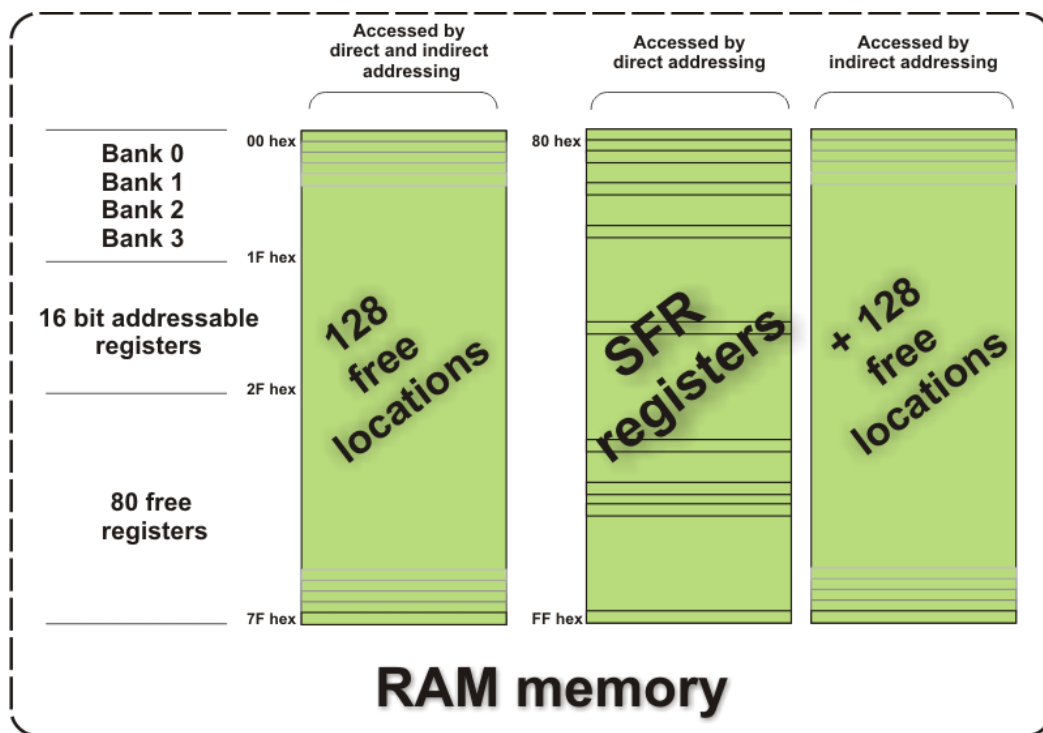

External Data Memory

Access to external memory is slower than access to internal data memory. There may be up to 64K Bytes of external data memory. Several 8051 devices provide on-chip XRAM space that is accessed with the same instructions as the traditional external data space. This XRAM space is typically enabled via proper setting of SFR register and overlaps the external memory space. Setting of that register must be manually done in code, before any access to external memory or XRAM space is made.

The *mikroPascal for 8051* has two memory type specifiers that refers to external memory space: `xdata` and `pdata`.

SFR Memory

The 8051 provides 128 bytes of memory for Special Function Registers (SFRs). SFRs are bit, byte, or word-sized registers that are used to control timers, counters, serial I/O, port I/O, and peripherals.

Refer to Special Function Registers for more information. See `sbit` also.

Related topics: Accessing individual bits, SFRs, Memory type specifiers, Memory models

MEMORY MODELS

The memory model determines the default memory type to use for function arguments, automatic variables, and declarations that include no explicit memory type. The *mikroPascal for 8051* provides three memory models:

- Small
- Compact
- Large

You may also specify the memory model on a function-by-function basis by adding the memory model to the function declaration.

Small memory model generates the fastest, most efficient code. This is default memory model. You may override the default memory type imposed by the memory model by explicitly declaring a variable with a memory type specifier.

Small model

In this model, all variables, by default, reside in the internal data memory of the 8051 system—as if they were declared explicitly using the data memory type specifier. In this memory model, variable access is very efficient. However, all objects (that are not explicitly located in another memory area) and the call stack must fit into the internal RAM.

Call Stack size is critical because the stack space used depends on the nesting depth of the various functions.

Compact model

Using the compact model, by default, all variables are allocated in a single page 256 bytes of external data memory of the 8051 system—as if they were explicitly declared using the pdata memory type specifier. This memory model can accommodate a maximum of 256 bytes of variables. The limitation is due to the addressing scheme used which is indirect through registers R0 and R1 (@R0, @R1). This memory model is not as efficient as the small model and variable access is not as fast. However, the compact model is faster than the large model. *mikroPascal for 8051* uses the @R0 and @R1 operands to access external memory with instructions that use 8 bit wide pointers and provide only the low-order byte of the address. The high-order address byte (or page) is provided by Port 2 on most 8051 derivatives (see data sheet for details).

Large model

In the large model all variables reside in external data memory (which may be up to 64K Bytes). This is the same as if they were explicitly declared using the xdata memory type specifier. The DPTR is used to address external memory. Instruction set is not optimized for this memory model(access to external memory) so it needs more code than the small or compact model to manipulate with the variables.

```
function xadd(a1 : byte; a2 : byte) : byte; large; // allocate param-  
eters and local variables in xdata space  
begin  
    result := a1+a2;  
end;
```

Related topics: Memory type specifiers, 8051 Memory Organization, Accessing individual bits, SFRs, Project Settings

Memory Type Specifiers

The *mikroPascal for 8051* supports usage of all memory areas. Each variable may be explicitly assigned to a specific memory space by including a memory type specifier in the declaration, or implicitly assigned (based on a memory model).

The following memory type specifiers can be used:

- code
- data
- idata
- bdata
- xdata
- pdata

Memory type specifiers can be included in svariable declaration.

For example:

```
data data_buffer : byte;           // puts data_buffer in data ram
xdata x_data : array[100] of char; // puts array in external memory
idata ibuffer : real;             // puts ibuffer in idata ramm
```

If no memory type is specified for a variable, the compiler locates the variable in the memory space determined by the memory model: Small, Compact, or Large.

code

Description	Program memory (64 KBytes); accessed by opcode MOVC @A+DPTR. The code memory type may be used for constants and functions. This memory is accessed using 16-bit addresses and may be on-chip or external.
Example	<pre>// puts txt in program memory code const txt : string [11] = 'Enter text:';</pre>

data

Description	Directly addressable internal data memory; fastest access to variables (128 bytes). This memory is directly accessed using 8-bit addresses and is the on-chip RAM of the 8051. It has the shortest (fastest) access time but the amount of data is limited in size (to 128 bytes or less).
Example	<pre>// puts x in data ram data x : byte;</pre>

idata

Description	Indirectly addressable internal data memory; accessed across the full internal address space (256 bytes). This memory is indirectly accessed using 8-bit addresses and is the on-chip RAM of the 8051. The amount of idata is limited in size (to 128 bytes or less) it is upper 128 addresses of RAM
Example	<pre>// puts x in idata ram idata x : byte;</pre>

bdata

Description	Bit-addressable internal data memory; supports mixed bit and byte access (16 bytes). This memory is directly accessed using 8-bit addresses and is the on-chip bit-addressable RAM of the 8051. Variables declared with the bdata type are bit-addressable and may be read and written using bit instructions. For more information about the bdata type refer to the Accessing Individual Bits.
Example	<pre>// puts x in bdata bdata x : byte;</pre>

xdata

Description	External data memory (64 KBytes); accessed by opcode MOVX @DPTR. This memory is indirectly accessed using 16-bit addresses and is the external data RAM of the 8051. The amount of xdata is limited in size (to 64K or less).
Example	<pre>// puts x in xdata xdata x : byte;</pre>

pdata

Description	Paged (256 bytes) external data memory; accessed by opcode MOVX @Rn. This memory is indirectly accessed using 8-bit addresses and is one 256-byte page of external data RAM of the 8051. The amount of pdata is limited in size (to 256 bytes).
Example	<pre>// puts x in pdata pdata x : byte;</pre>

Related topics: 8051 Memory Organization, Memory models, Accessing individual bits, SFRs, Constants, Functions

CHAPTER

5

mikroPascal for 8051 Language Reference

The *mikroPascal for 8051* Language Reference describes the syntax, semantics and implementation of the *mikroPascal for 8051* language.

The aim of this reference guide is to provide a more understandable description of the *mikroPascal for 8051* language to the user.

- Lexical Elements

Whitespace
Comments
Tokens

Literals
Keywords
Identifiers
Punctuators

- Program Organization

Program Organization
Scope and Visibility
Units

- Variables

- Constants

- Labels

- Functions and Procedures

Functions
Procedures

- Types

Simple Types
Arrays
Strings
Pointers
Records
Types Conversions

Implicit Conversion
Explicit Conversion

- Operators

Introduction to Operators
Operators Precedence and Associativity
Arithmetic Operators
Relational Operators
Bitwise Operators
Boolean Operators

- Expressions

Expressions

- Statements

Introduction to Statements
Assignment Statements
Compound Statements (Blocks)
Conditional Statements

If Statement
Case Statement

Iteration Statements (Loops)

For Statement
While Statement
Repeat Statement

Jump Statements

Break and Continue Statements
Exit Statement
Goto Statement

asm Statement

- Directives

Compiler Directives
Linker Directives

LEXICAL ELEMENTS OVERVIEW

The following topics provide a formal definition of the *mikroPascal for 8051* lexical elements. They describe different categories of word-like units (tokens) recognized by *mikroPascal for 8051*.

In the tokenizing phase of compilation, the source code file is parsed (i.e. broken down) into tokens and whitespace. The tokens in *mikroPascal for 8051* are derived from a series of operations performed on your programs by the compiler.

WHITESPACE

Whitespace is a collective name given to spaces (blanks), horizontal and vertical tabs, newline characters and comments. Whitespace can serve to indicate where tokens start and end, but beyond this function, any surplus whitespace is discarded. For example, two sequences

```
var i : char;  
    j : word;
```

and

```
var  
i : char;  
  
    j : word;
```

are lexically equivalent and parse identically to give nine tokens:

```
var  
i  
:  
char  
;  
j  
:  
word  
;
```

Whitespace in Strings

The ASCII characters representing whitespace can occur within string literals, in which case they are protected from the normal parsing process (they remain a part of the string). For example,

```
some_string := 'mikro foo';
```

parses into four tokens, including a single string literal token:

```
some_string
:=
'mikro foo'
;
```

COMMENTS

Comments are pieces of a text used to annotate a program, and are technically another form of whitespace. Comments are for the programmer's use only. They are stripped from the source text before parsing.

There are two ways to create comments in mikroPascal. You can use multi-line comments which are enclosed with braces or (* and *):

```
{ All text between left and right brace
  constitutes a comment. May span multiple lines. }

(* Comment can be
   written in this way too. *)
```

or single-line comments:

```
// Any text between a double-slash and the end of the
// line constitutes a comment spanning one line only.
```

Nested comments

mikroPascal doesn't allow nested comments. The attempt to nest a comment like this

```
{ i { identifier } : word; }
```

fails, because the scope of the first open brace "{" ends at the first closed brace "}". This gives us

```
: word; }
```

which would generate a syntax error.

TOKENS

Token is the smallest element of the Pascal program that compiler can recognize. The parser separates tokens from the input stream by creating the longest token possible using the input characters in a left-to-right scan.

mikroPascal for 8051 recognizes the following kinds of tokens:

- keywords
- identifiers
- constants
- operators
- punctuators (also known as separators)

Token Extraction Example

Here is an example of token extraction. Take a look at the following example code sequence:

```
end_flag := 0;
```

First, note that `end_flag` would be parsed as a single identifier, rather than as the keyword `end` followed by the identifier `_flag`.

The compiler would parse it as the following four tokens:

```
end_flag // variable identifier
:=      // assignment operator
0       // literal
;       // statement terminator
```

Note that `:=` parses as one token (the longest token possible), not as token `:` followed by token `=`.

LITERALS

Literals are tokens representing fixed numeric or character values.

The data type of a constant is deduced by the compiler using such clues as numeric value and format used in the source code.

Integer Literals

Integral values can be represented in decimal, hexadecimal, or binary notation.

In decimal notation, numerals are represented as a sequence of digits (without commas, spaces, or dots), with optional prefix `+` or `-` operator to indicate the sign. Values default to positive (`6258` is equivalent to `+6258`).

The dollar-sign prefix (`$`) or the prefix `0x` indicates a hexadecimal numeral (for example, `$8F` or `0x8F`).

The percent-sign prefix (`%`) indicates a binary numeral (for example, `%01010000`).

Here are some examples:

```
11      // decimal literal
$11     // hex literal, equals decimal 17
0x11    // hex literal, equals decimal 17
%11     // binary literal, equals decimal 3
```

The allowed range of values is imposed by the largest data type in *mikroPascal for 8051* – `longint`. Compiler will report an error if the literal exceeds `2147483647` (`$7FFFFFFF`).

Floating Point Literals

A floating-point value consists of:

- Decimal integer
- Decimal point
- Decimal fraction
- `e` or `E` and a signed integer exponent (optional)

You can omit either the decimal integer or decimal fraction (but not both).

Negative floating constants are taken as positive constants with the unary operator minus (`-`) prefixed.

mikroPascal for 8051 limits floating-point constants to range $\pm 1.17549435082 * 10^{-38} .. \pm 6.80564774407 * 10^{38}$.

Here are some examples:

```
0.           // = 0.0
-1.23        // = -1.23
23.45e6      // = 23.45 * 10^6
2e-5         // = 2.0 * 10^-5
3E+10        // = 3.0 * 10^10
.09E34       // = 0.09 * 10^34
```

Character Literals

Character literal is one character from the extended ASCII character set, enclosed with apostrophes.

Character literal can be assigned to variables of the `byte` and `char` type (variable of byte will be assigned the ASCII value of the character). Also, you can assign character literal to a string variable.

Note: Quotes ("") have no special meaning in *mikroPascal for 8051*.

String Literals

String literal is a sequence of characters from the extended ASCII character set, written in one line and enclosed with apostrophes. Whitespace is preserved in string literals, i.e. parser does not “go into” strings but treats them as single tokens.

Length of string literal is a number of characters it consists of. String is stored internally as the given sequence of characters plus a final `null` character. This `null` character is introduced to terminate the string, it does not count against the string's total length.

String literal with nothing in between the apostrophes (null string) is stored as a single `null` character.

You can assign string literal to a string variable or to an array of `char`.

Here are several string literals:

```
'Hello world!'           // message, 12 chars long
'Temperature is stable' // message, 21 chars long
'  '                    // two spaces, 2 chars long
'C'                      // letter, 1 char long
''                       // null string, 0 chars long
```

The apostrophe itself cannot be a part of the string literal, i.e. there is no escape sequence. You can use the built-in function `Chr` to print an apostrophe: `Chr(39)`. Also, see String Splicing.

KEYWORDS

Keywords are the words reserved for special purposes and must not be used as normal identifier names.

Beside standard Pascal keywords, all relevant SFRs are defined as global variables and represent reserved words that cannot be redefined (for example: `W0`, `TMR1`, `T1CON`, etc). Probe the Code Assistant for specific letters (Ctrl+Space in Editor) or refer to Predefined Globals and Constants.

Here is the alphabetical listing of keywords in Pascal:

- absolute
- abstract
- and
- array
- as
- asm
- assembler
- at
- automated
- bdata
- begin
- bit
- case
- cdecl
- class
- code
- compact
- const
- constructor
- contains
- data
- default
- deprecated
- destructor
- dispid
- dispinterface
- div
- do
- downto
- dynamic
- end
- except
- export
- exports
- external

- far
- file
- final
- finalization
- finally
- for
- forward
- goto
- helper
- idata
- if
- ilevel
- implementation
- implements
- in
- index
- inherited
- initialization
- inline
- interface
- is
- label
- library
- message
- mod
- name
- near
- nil
- nodefault
- not
- object
- of
- on
- operator
- or
- org
- out
- overload
- override
- package
- packed
- pascal
- pdata
- platform
- private
- procedure
- program
- property
- protected

- public
- published
- raise
- read
- readonly
- record
- register
- reintroduce
- repeat
- requires
- safecall
- sbit
- sealed
- set
- shl
- shr
- small
- stdcall
- stored
- string
- threadvar
- to
- try
- type
- unit
- until
- uses
- var
- virtual
- volatile
- while
- with
- write
- writeonly
- xdata
- xor

Also, mikroPascal includes a number of predefined identifiers used in libraries. You can replace them by your own definitions, if you plan to develop your own libraries. For more information, see mikroPascal Libraries.

IDENTIFIERS

Identifiers are arbitrary names of any length given to functions, variables, symbolic constants, user-defined data types and labels. All these program elements will be referred to as objects throughout the help (don't get confused about the meaning of object in object-oriented programming).

Identifiers can contain the letters a to z and A to Z, underscore character “_”, and digits from 0 to 9. The only restriction is that the first character must be a letter or an underscore.

Case Sensitivity

Pascal is not case sensitive, so `Sum`, `sum`, and `suM` are an equivalent identifier.

Uniqueness and Scope

Although identifier names are arbitrary (according to the stated rules), if the same name is used for more than one identifier within the same scope then error arises. Duplicated names are illegal within same scope. For more information, refer to Scope and Visibility.

Identifier Examples

Here are some valid identifiers:

```
temperature_V1
Pressure
no_hit
dat2string
SUM3
_vtext
```

... and here are some invalid identifiers:

```
7temp           // NO -- cannot begin with a numeral
%higher         // NO -- cannot contain special characters
xor             // NO -- cannot match reserved word
j23.07.04       // NO -- cannot contain special characters (dot)
```

PUNCTUATORS

The mikroPascal punctuators (also known as separators) are:

- [] – Brackets
- () – Parentheses
- , – Comma
- ; – Semicolon
- : – Colon
- . – Dot

Brackets

Brackets [] indicate single and multidimensional array subscripts:

```
var alphabet : array[1..30] of byte;
// ...
alphabet[3] := 'c';
```

For more information, refer to Arrays.

Parentheses

Parentheses () are used to group expressions, isolate conditional expressions and indicate function calls and function declarations:

```
d := c * (a + b);           // Override normal precedence
if (d = z) then ...       // Useful with conditional statements
func();                   // Function call, no arguments
function func2(n : word); // Function declaration with parameters
```

For more information, refer to Operators Precedence and Associativity, Expressions and Functions and Procedures.

Comma

Comma (,) separates the arguments in function calls:

```
LCD_Out(1, 1, txt);
```

Further, the comma separates identifiers in declarations:

```
var i, j, k : byte;
```

The comma also separates elements of array in initialization lists:

```
const MONTHS : array[1..12] of byte =
(31,28,31,30,31,30,31,31,30,31,30,31);
```

Semicolon

Semicolon (;) is a statement terminator. Every statement in Pascal must be terminated with a semicolon. The exceptions are: the last (outer most) end statement in the program which is terminated with a dot and the last statement before end which doesn't need to be terminated with a semicolon.

For more information, see Statements.

Colon

Colon (:) is used in declarations to separate identifier list from type identifier. For example:

```
var
  i, j : byte;
  k    : word;
```

In the program, use the colon to indicate a labeled statement:

```
start:  nop;
  ...
goto start;
```

For more information, refer to Labels.

Dot

Dot (.) indicates an access to a field of a record. For example:

```
person.surname := 'Smith';
```

For more information, refer to Records.

Dot is a necessary part of floating point literals. Also, dot can be used for accessing individual bits of registers in mikroPascal.

PROGRAM ORGANIZATION

Pascal imposes quite strict program organization. Below you can find models for writing legible and organized source files. For more information on file inclusion and scope, refer to Units and Scope and Visibility.

Organization of Main Unit

Basically, the main source file has two sections: declaration and program body. Declarations should be in their proper place in the code, organized in an orderly manner. Otherwise, the compiler may not be able to comprehend the program correctly.

When writing code, follow the model presented below. The main unit should look like this:

```
program { program name }
uses { include other units }

//*****
/* Declarations (globals):
//*****

{ constants declarations }
const ...

{ types declarations }
type ...

{ variables declarations }
var Name[, Name2...] : [ ^ ]type; [ absolute 0x123; ] [ external; ]
[ volatile; ] [ register; ] [ sfr; ]

{ labels declarations }
label ...

{ procedures declarations }
procedure procedure_name(parameter_list);
{ local declarations }
begin
    ...
end;

{ functions declarations }
function function_name(parameter_list) : return_type;
{ local declarations }
begin
    ...
end;
```



```

/*****
/* Program body:
/*****

begin
  { write your code here }
end.

```

Organization of Other Units

Units other than main start with the keyword `unit`. Implementation section starts with the keyword `implementation`. Follow the model presented below:

```

unit { unit name }
uses { include other units }

/*****
/* Interface (globals):
/*****

{ constants declarations }
const ...

{ types declarations }
type ...

{ variables declarations }
var Name[, Name2...] : [ ^ ] type; [ absolute 0x123; ] [ external; ]
[ volatile; ] [ register; ] [ sfr; ]

{ procedures prototypes }
procedure procedure_name([ var] [ const] ParamName : [ ^ ] type; [ var]
[ const] ParamName2, ParamName3 : [ ^ ] type);

{ functions prototypes }
function function_name([ var] [ const] ParamName : [ ^ ] type; [ var]
[ const] ParamName2, ParamName3 : [ ^ ] type) : [ ^ ] type;

/*****
/* Implementation:
/*****

implementation

{ constants declarations }
const ...

{ types declarations }
type ...

```

```
{ variables declarations }
var Name[, Name2...] : [ ^ ] type; [ absolute 0x123;] [ external;]
[ volatile;] [ register;] [ sfr;]

{ labels declarations }
label ...

{ procedures declarations }
procedure procedure_name([ var] [ const] ParamName : [ ^ ] type; [ var]
[ const] ParamName2, ParamName3 : [ ^ ] type); [ ilevel 0x123;] [ over-
load;] [ forward;]
{ local declarations }
begin
...
end;

{ functions declarations }
function function_name([ var] [ const] ParamName : [ ^ ] type; [ var]
[ const] ParamName2, ParamName3 : [ ^ ] type) : [ ^ ] type; [ ilevel 0x123;]
[ overload;] [ forward;]
{ local declarations }
begin
...
end;

end.
```

Note: constants, types and variables used in the `implementation` section are inaccessible to other units. This feature is not applied to the procedures and functions in the current version, but it will be added to the future ones.

Note: Functions and procedures must have the same declarations in the interface and implementation section. Otherwise, compiler will report an error.

SCOPE AND VISIBILITY

Scope

The scope of an identifier is a part of the program in which the identifier can be used to access its object. There are different categories of scope, which depends on how and where identifiers are declared:

Place of declaration	Scope
Identifier is declared in the declaration of a program, function, or procedure	Scope extends from the point where it is declared to the end of the current block, including all blocks enclosed within that scope. Identifiers in the outermost scope (file scope) of the main unit are referred to as globals, while other identifiers are locals.
Identifier is declared in the interface section of a unit	Scope extends the interface section of a unit from the point where it is declared to the end of the unit, and to any other unit or program that uses that unit.
Identifier is declared in the implementation section of a unit, but not within the block of any function or procedure	Scope extends from the point where it is declared to the end of the unit. The identifier is available to any function or procedure in the unit.

Visibility

The visibility of an identifier is that region of the program source code from which legal access to the identifier's associated object can be made.

Scope and visibility usually coincide, though there are circumstances under which an object becomes temporarily hidden by the appearance of a duplicate identifier, i.e. the object still exists but the original identifier cannot be used to access it until the scope of the duplicate identifier is ended.

Technically, visibility cannot exceed scope, but scope can exceed visibility.

UNITS

In *mikroPascal for 8051*, each project consists of a single project file and one or more unit files. Project file, with extension `.mproj` contains information about the project, while unit files, with extension `.mpas`, contain the actual source code.

Units allow you to:

- break large programs into encapsulated parts that can be edited separately,
- create libraries that can be used in different projects,
- distribute libraries to other developers without disclosing the source code.

Each unit is stored in its own file and compiled separately. Compiled units are linked to create an application. In order to build a project, the compiler needs either a source file or a compiled unit file (`.mcl` file) for each unit.

Uses Clause

mikroPascal for 8051 includes units by means of the uses clause. It consists of the reserved word `uses`, followed by one or more comma-delimited unit names, followed by a semicolon. Extension of the file should not be included. There can be at most one uses clause in each source file, and it must appear immediately after the program (or unit) name.

Here's an example:

`uses utils, strings, Unit2, MyUnit;`For the given unit name, the compiler will check for the presence of `.mcl` and `.mpas` files, in order specified by the search paths.

- If both `.mpas` and `.mcl` files are found, the compiler will check their dates and include the newer one in the project. If the `.mpas` file is newer than `.mcl`, a new library will be written over the old one;
- If only `.mpas` file is found, the compiler will create the `.mcl` file and include it in the project;
- If only `.mcl` file is present, i.e. no source code is available, the compiler will include it as it is found;
- If none found, the compiler will issue a "File not found" warning.

Main Unit

Every project in *mikroPascal for 8051* requires a single main unit file. The main unit file is identified by the keyword `program` at the beginning; it instructs the compiler where to "start".

After you have successfully created an empty project with the Project Wizard, the Code Editor will display a new main unit. It contains the bare-bones of the Pascal program:

```
program MyProject;  
  
{ main procedure }  
begin  
  { Place program code here }  
end.
```

Nothing should precede the keyword `program` except comments. After the program name, you can optionally place the `uses` clause.

Place all global declarations (constants, variables, types, labels, routines) before the keyword `begin`.

Other Units

Units other than main start with the keyword `unit`. Newly created blank unit contains the bare-bones:

```
unit MyUnit;  
  
implementation  
  
end.
```

Other than comments, nothing should precede the keyword `unit`. After the unit name, you can optionally place the `uses` clause.

Interface Section

Part of the unit above the keyword `implementation` is referred to as interface section. Here, you can place global declarations (constants, variables, labels and types) for the project.

You do not define routines in the interface section. Instead, state the prototypes of routines (from implementation section) that you want to be visible outside the unit. Prototypes must match the declarations exactly.

Implementation Section

Implementation section hides all irrelevant innards from other units, allowing encapsulation of code.

Everything declared below the keyword `implementation` is private, i.e. has its scope limited to the file. When you declare an identifier in the implementation section of a unit, you cannot use it outside the unit, but you can use it in any block or routine defined within the unit.

By placing the prototype in the interface section of the unit (above the `implementation`) you can make the routine public, i.e. visible outside of unit. Prototypes must match the declarations exactly.

VARIABLES

Variable is object whose value can be changed during the runtime. Every variable is declared under unique name which must be a valid identifier. This name is used for accessing the memory location occupied by a variable.

Variables are declared in the declaration part of the file or routine — each variable needs to be declared before being used. Global variables (those that do not belong to any enclosing block) are declared below the `uses` statement, above the keyword `begin`.

Specifying a data type for each variable is mandatory. Syntax for variable declaration is:

```
var identifier_list : type;
```

`identifier_list` is a comma-delimited list of valid identifiers and `type` can be any data type.

For more details refer to Types and Types Conversions. For more information on variables' scope refer to the chapter Scope and Visibility.

Pascal allows shortened syntax with only one keyword `var` followed by multiple variable declarations. For example:

```
var i, j, k : byte;  
    counter, temp : word;  
    samples : array[100] of word;
```

Variables and 8051

Every declared variable consumes part of RAM. Data type of variable determines not only allowed range of values, but also the space variable occupies in RAM. Bear in mind that operations using different types of variables take different time to be completed. *mikroPascal for 8051* recycles local variable memory space – local variables declared in different functions and procedures share the same memory space, if possible.

There is no need to declare SFRs explicitly, as *mikroPascal for 8051* automatically declares relevant registers as global variables of `volatile word` see SFR for details.

CONSTANTS

Constant is a data whose value cannot be changed during the runtime. Using a constant in a program consumes no RAM. Constants can be used in any expression, but cannot be assigned a new value.

Constants are declared in the declaration part of a program or routine. You can declare any number of constants after the keyword `const`:

```
const constant_name [ : type] = value;
```

Every constant is declared under unique `constant_name` which must be a valid identifier. It is a tradition to write constant names in uppercase. Constant requires you to specify `value`, which is a literal appropriate for the given type. `type` is optional and in the absence of `type`, the compiler assumes the “smallest” of all types that can accommodate `value`.

Note: You cannot omit `type` when declaring a constant array.

Pascal allows shorthand syntax with only one keyword `const` followed by multiple constant declarations. Here’s an example:

```
const
  MAX : longint = 10000;
  MIN = 1000;      // compiler will assume word type
  SWITCH = 'n';   // compiler will assume char type
  MSG = 'Hello';  // compiler will assume string type
  MONTHS : array[1..12] of byte = (31,28,31,30,31,30,31,31,30,31,30,31);
```

LABELS

Labels serve as targets for goto statements. Mark the desired statement with a label and colon like this:

```
label_identifier : statement
```

Before marking a statement, you must declare a label. Labels are declared in declaration part of unit or routine, similar to variables and constants. Declare labels using the keyword `label`:

```
label label1, ..., labeln;
```

Name of the label needs to be a valid identifier. The label declaration, marked statement, and `goto` statement must belong to the same block. Hence it is not possible to jump into or out of a procedure or function. Do not mark more than one statement in a block with the same label.

Here is an example of an infinite loop that calls the `Beep` procedure repeatedly:

```
label loop;  
...  
loop:  
    Beep;  
    goto loop;
```

Note: label should be followed by end of line (CR) otherwise compiler will report an error:

```
label loop;  
...  
loop: Beep; // compiler will report an error  
loop: // compiler will report an error
```

FUNCTIONS AND PROCEDURES

Functions and procedures, collectively referred to as routines, are subprograms (self-contained statement blocks) which perform a certain task based on a number of input parameters. When executed, a function returns a value while procedure does not.

mikroPascal for 8051 does not support inline routines.

Functions

A function is declared like this:

```
function function_name(parameter_list) : return_type;
  { local declarations }
begin
  { function body }
end;
```

`function_name` represents a function's name and can be any valid identifier. `return_type` is a type of return value and can be any simple type. Within parentheses, `parameter_list` is a formal parameter list very similar to variable declaration. In Pascal, parameters are always passed to a function by the value — to pass an argument by address, add the keyword `var` ahead of identifier.

`Local declarations` are optional declarations of variables and/or constants, local for the given function. `Function body` is a sequence of statements to be executed upon calling the function.

Calling a function

A function is called by its name, with actual arguments placed in the same sequence as their matching formal parameters. The compiler is able to coerce mismatching arguments to the proper type according to implicit conversion rules. Upon a function call, all formal parameters are created as local objects initialized by values of actual arguments. Upon return from a function, a temporary object is created in the place of the call and it is initialized by the value of the function result. This means that function call as an operand in complex expression is treated as the function result.

In standard Pascal, a `function_name` is automatically created local variable that can be used for returning a value of a function. *mikroPascal for 8051* also allows you to use the automatically created local variable `result` to assign the return value of a function if you find function name to be too ponderous. If the return value of a function is not defined the compiler will report an error.

Function calls are considered to be primary expressions and can be used in situations where expression is expected. A function call can also be a self-contained statement and in that case the return value is discarded.

Example

Here's a simple function which calculates x^n based on input parameters `x` and `n` (`n > 0`):

```
function power(x, n : byte) : longint;
var i : byte;
begin
  i := 0; result := 1;
  if n > 0 then
    for i := 1 to n do result := result*x;
end;
```

Now we could call it to calculate 312 for example:

```
tmp := power(3, 12);
```

PROCEDURES

Procedure is declared like this:

```
procedure procedure_name(parameter_list);
{ local declarations }
begin
  { procedure body }
end;
```

`procedure_name` represents a procedure's name and can be any valid identifier. Within parentheses, `parameter_list` is a formal parameter list very similar to variable declaration. In Pascal, parameters are always passed to a procedure by the value — to pass an argument by address, add the keyword `var` ahead of identifier.

`Local declarations` are optional declaration of variables and/or constants, local for the given procedure. `Procedure body` is a sequence of statements to be executed upon calling the procedure.

Calling a procedure

A procedure is called by its name, with actual arguments placed in the same sequence as their matching formal parameters. The compiler is able to coerce mismatching arguments to the proper type according to implicit conversion rules. Upon procedure call, all formal parameters are created as local objects initialized by the values of actual arguments.

Procedure call is a self-contained statement.

Example

Here's an example procedure which transforms its input time parameters, preparing them for output on LCD:

```
procedure time_prep(var sec, min, hr : byte);
begin
  sec := ((sec and $F0) shr 4)*10 + (sec and $0F);
  min := ((min and $F0) shr 4)*10 + (min and $0F);
  hr := ((hr and $F0) shr 4)*10 + (hr and $0F);
end;
```

Function Pointers

Function pointers are allowed in *mikroPascal for 8051*. The example shows how to define and use a function pointer:

Example:

Example demonstrates the usage of function pointers. It is shown how to declare a procedural type, a pointer to function and finally how to call a function via pointer.

```
program Example;

  type TMyFunctionType = function (param1, param2: byte; param3: word)
  : word; // First, define the procedural type
  var MyPtr: ^TMyFunctionType;
  // This is a pointer to previously defined type
  Sample: word;

  function Func1(p1, p2: byte; p3: word): word; // Now,
  define few functions which will be pointed to. Make sure that param-
  eters match the type definition
  begin
    result := p1 and p2 or p3; // return something
  end;
```

```

function Func2(abc: byte; def: byte; ghi: word): word;    // Another
function of the same kind. Make sure that parameters match the type
definition
begin
    result := abc * def + ghi;           // return something
end;

function Func3(first, yellow: byte; monday: word): word; // Yet
another function. Make sure that parameters match the type defini-
tion
begin
    result := monday - yellow - first; // return something
end;

// main program:
begin
    MyPtr := @Func1;           // MyPtr now points to Func1
    Sample := MyPtr^(1, 2, 3); // Perform function call via
pointer, call Func1, the return value is 3
    MyPtr := @Func2;           // MyPtr now points to Func2
    Sample := MyPtr^(1, 2, 3); // Perform function call via
pointer, call Func2, the return value is 5
    MyPtr := @Func3;           // MyPtr now points to Func3
    Sample := MyPtr^(1, 2, 3); // Perform function call via
pointer, call Func3, the return value is 0
end.

```

A function can return a complex type. Follow the example bellow to learn how to declare and use a function which returns a complex type.

Example:

This example shows how to declare a function which returns a complex type.

```

program Example;

type TCircle = record // Record
    CenterX, CenterY: word;
    Radius: byte;
end;

var MyCircle: TCircle; // Global variable

function DefineCircle(x, y: word; r: byte): TCircle; // DefineCircle
function returns a Record

```

```
begin
  result.CenterX := x;
  result.CenterY := y;
  result.Radius  := r;
end;

begin
  MyCircle := DefineCircle(100, 200, 30);           //
  Get a Record via function call
  MyCircle.CenterX := DefineCircle(100, 200, 30).CenterX + 20; //
  Access a Record field via function call
  //                               |-----|  |-----|
  //                               |         |  |         |
  //                               |         |  |         |
  //                               |         |  |         |
  field of TCircle                Function returns TCircle  Access to one
end.
```

Forward declaration

A function can be declared without having it followed by its implementation, by having it followed by the forward procedure. The effective implementation of that function must follow later in the unit. The function can be used after a forward declaration as if it had been implemented already. The following is an example of a forward declaration:

```
program Volume;

var Volume : word;

function First(a, b : word) : word; forward;

function Second(c : word) : word;
var tmp : word;
begin
  tmp := First(2, 3);
  result := tmp * c;
end;

function First(a, b : word) : word;
begin
  result := a * b;
end;

begin
  Volume := Second(4);
end.
```

TYPES

Pascal is strictly typed language, which means that every variable and constant need to have a strictly defined type, known at the time of compilation.

The type serves:

- to determine correct memory allocation required,
- to interpret the bit patterns found in the object during subsequent accesses,
- in many type-checking situations, to ensure that illegal assignments are trapped.

mikroPascal supports many standard (predefined) and user-defined data types, including signed and unsigned integers of various sizes, arrays, strings, pointers and records.

Type Categories

Types can be divided into:

- simple types
- arrays
- strings
- pointers
- records

SIMPLE TYPES

Simple types represent types that cannot be divided into more basic elements and are the model for representing elementary data on machine level. Basic memory unit in *mikroPascal for 8051* has 16 bits.

Here is an overview of simple types in *mikroPascal for 8051*:

Type	Size	Range
<code>byte</code> , <code>char</code>	8-bit	0 .. 255
<code>short</code>	8-bit	-127 .. 128
<code>word</code>	16-bit	0 .. 65535
<code>integer</code>	16-bit	-32768 .. 32767
<code>dword</code>	32-bit	0 .. 4294967295
<code>longint</code>	32-bit	-2147483648 .. 2147483647
<code>real</code>	32-bit	$\pm 1.17549435082 * 10^{-38}$.. $\pm 6.80564774407 * 10^38$
<code>bit</code>	1-bit	0 or 1
<code>sbit</code>	1-bit	0 or 1

You can assign signed to unsigned or vice versa only using the explicit conversion. Refer to Types Conversions for more information.

ARRAYS

An array represents an indexed collection of elements of the same type (called the base type). Because each element has a unique index, arrays, unlike sets, can meaningfully contain the same value more than once.

Array Declaration

Array types are denoted by constructions in the following form:

```
array[ index_start .. index_end] of type
```

Each of the elements of an array is numbered from `index_start` through `index_end`. The specifier `index_start` can be omitted along with dots, in which case it defaults to zero.

Every element of an array is of `type` and can be accessed by specifying array name followed by element's index within brackets.

Here are a few examples of array declaration:

```
var  
  weekdays : array[1..7] of byte;  
  samples  : array[50] of word;  
  
begin  
  // Now we can access elements of array variables, for example:  
  samples[0] := 1;  
  if samples[37] = 0 then ...
```

Constant Arrays

Constant array is initialized by assigning it a comma-delimited sequence of values within parentheses. For example:

```
// Declare a constant array which holds number of days in each month:  
const MONTHS : array[1..12] of byte =  
(31,28,31,30,31,30,31,31,30,31,30,31);
```

The number of assigned values must not exceed the specified length. The opposite is possible, when the trailing "excess" elements are assigned zeroes.

For more information on arrays of `char`, refer to Strings.

Multi-dimensional Arrays

Multidimensional arrays are constructed by declaring arrays of array type. These arrays are stored in memory in such way that the right most subscript changes fastest, i.e. arrays are stored “in rows”. Here is a sample 2-dimensional array:

```
m : array[ 5] of array[ 10] of byte;    // 2-dimensional array of size 5x10
```

A variable `m` is an array of 5 elements, which in turn are arrays of 10 byte each. Thus, we have a matrix of 5x10 elements where the first element is `m[0][0]` and last one is `m[4][9]`. The first element of the 4th row would be `m[3][0]`.

STRINGS

A string represents a sequence of characters equivalent to an array of `char`. It is declared like this:

```
string_name : string[ length]
```

The specifier `length` is a number of characters the string consists of. String is stored internally as the given sequence of characters plus a final `null` character which is introduced to terminate the string. It does not count against the string's total length.

A null string (") is stored as a single `null` character.

You can assign string literals or other strings to string variables. String on the right side of an assignment operator has to be shorter or of equal length than the one on the right side. For example:

```
var
  msg1 : string[ 20] ;
  msg2 : string[ 19] ;

begin
  msg1 := 'This is some message';
  msg2 := 'Yet another message';

  msg1 := msg2; // this is ok, but vice versa would be illegal
  ...
```

Alternately, you can handle strings element-by-element. For example:

```
var s : string[ 5] ;
...
s := 'mik';
{
s[ 0] is char literal 'm'
s[ 1] is char literal 'i'
s[ 2] is char literal 'k'
s[ 3] is zero
s[ 4] is undefined
s[ 5] is undefined
}
```

Be careful when handling strings in this way, since overwriting the end of a string will cause an unpredictable behavior.

String Concatenating

mikroPascal for 8051 allows you to concatenate strings by means of plus operator. This kind of concatenation is applicable to string variables/literals, character variables/literals. For control characters, use the non-quoted hash sign and a numeral (e.g. #13 for CR).

Here is an example:

```
var msg      : string[ 20] ;
    res_txt  : string[ 5] ;
    res, channel : word;

begin

    //...

    // Get result of ADC
    res := Adc_Read(channel);

    // Create string out of numeric result
    WordToStr(res, res_txt);

    // Prepare message for output
    msg := 'Result is ' +      // Text "Result is"
           res_txt           ; // Result of ADC

    //...
```

Note: In current version plus operator for concatenating strings will accept at most two operands.

Note

mikroPascal for 8051 includes a String Library which automatizes string related tasks.

Pointers

A pointer is a data type which holds a memory address. While a variable accesses that memory address directly, a pointer can be thought of as a reference to that memory address.

To declare a pointer data type, add a caret prefix (^) before type. For example, in order to create a pointer to an `integer`, write:

```
^integer;
```

In order to access data at the pointer's memory location, add a caret after the variable name. For example, let's declare variable `p` which points to a `word`, and then assign value 5 to the pointed memory location:

```
var p : ^word;  
...  
p^ := 5;
```

A pointer can be assigned to another pointer. However, note that only the address, not the value, is copied. Once you modify the data located at one pointer, the other pointer, when dereferenced, also yields modified data.

Pointers to program memory space are declared using the keyword `const`:

```
program const_ptr;  
  
// constant array will be stored in program memory  
const b_array: array[5] of byte = (1,2,3,4,5);  
  
const ptr: ^byte;      // ptr is pointer to program memory space  
  
begin  
    ptr := @b_array; // ptr now points to b_array[0]  
    P0 := ptr^;  
    ptr := ptr + 3;  // ptr now points to b_array[3]  
    P0 := ptr^;  
end.
```

Pointers to procedures are currently under construction.

@ Operator

The @ operator returns the address of a variable or routine, i.e. @ constructs a pointer to its operand. The following rules are applied to @:

- If `X` is a variable, `@X` returns the address of `X`.
- If `F` is a routine (a function or procedure), `@F` returns `F`'s entry point (the result is of `longint`).

RECORDS

A record (analogous to a structure in some languages) represents a heterogeneous set of elements. Each element is called a field. The declaration of the record type specifies a name and type for each field. The syntax of a record type declaration is

```
type recordTypeName = record
    fieldList1 : type1;
    ...
    fieldListn : typen;
end;
```

where `recordTypeName` is a valid identifier, each `type` denotes a type, and each `fieldList` is a valid identifier or a comma-delimited list of identifiers. The scope of a field identifier is limited to the record in which it occurs, so you don't have to worry about naming conflicts between field identifiers and other variables.

Note: In *mikroPascal for 8051*, you cannot use the `record` construction directly in variable declarations, i.e. without `type`.

For example, the following declaration creates a record type called `TDot`:

```
type
    TDot = record
        x, y : real;
end;
```

Each `TDot` contains two fields: `x` and `y` coordinates. Memory is allocated when you declare the record, like this:

```
var m, n: TDot;
```

This variable declaration creates two instances of `TDot`, called `m` and `n`.

A field can be of previously defined record type. For example:

```
// Structure defining a circle:
type
    TCircle = record
        radius : real;
        center : TDot;
end;
```

Accessing Fields

You can access the fields of a record by means of dot (.) as a direct field selector. If we have declared variables `circle1` and `circle2` of previously defined type `TCircle`:

```
var circle1, circle2 : TCircle;
```

we could access their individual fields like this:

```
circle1.radius := 3.7;  
circle1.center.x := 0;  
circle1.center.y := 0;
```

You can also commit assignments between complex variables, if they are of the same type:

```
circle2 := circle1; // This will copy values of all fields
```

TYPES CONVERSIONS

Conversion of variable of one type to a variable of another type is typecasting. *mikroPascal for 8051* supports both implicit and explicit conversions for built-in types.

Implicit Conversion

Compiler will provide an automatic implicit conversion in the following situations:

- statement requires an expression of particular type (according to language definition), and we use an expression of different type,
- operator requires an operand of particular type, and we use an operand of different type,
- function requires a formal parameter of particular type, and we pass it an object of different type,
- `result` does not match the declared function return type.

Promotion

When operands are of different types, implicit conversion promotes the less complex type to more complex type taking the following steps:

```
byte/char  → word
short      → integer
short      → longint
integer    → longint
integer    → real
```

Higher bytes of extended unsigned operand are filled with zeroes. Higher bytes of extended signed operand are filled with bit sign (if number is negative, fill higher bytes with one, otherwise with zeroes). For example:

```
var a : byte; b : word;
...
a := $FF;
b := a; // a is promoted to word, b becomes $00FF
```

Clipping

In assignments and statements that require an expression of particular type, destination will store the correct value only if it can properly represent the result of expression, i.e. if the result fits in destination range.

If expression evaluates to a more complex type than expected, excess of data will be simply clipped (higher bytes are lost).

```
var i : byte; j : word;
...
j := $FF0F;
i := j;    // i becomes $0F, higher byte $FF is lost
```

Explicit Conversion

Explicit conversion can be executed at any point by inserting type keyword (*byte*, *word*, *short*, *integer*, *longint* or *real*) ahead of an expression to be converted. The expression must be enclosed in parentheses. Explicit conversion can be performed only on the operand right of the assignment operator.

Special case is conversion between signed and unsigned types. Explicit conversion between signed and unsigned data does not change binary representation of data — it merely allows copying of source to destination.

For example:

```
var a : byte; b : short;
...
b := -1;
a := byte(b);    // a is 255, not 1

// This is because binary representation remains
// 11111111; it's just interpreted differently now
```

You can't execute explicit conversion on the operand left of the assignment operator:

```
word(b) := a;    // Compiler will report an error
```

Conversions Examples

Here is an example of conversion:

```
var a, b, c : byte;
      d : word;

...
a := 241;
b := 128;

c := a + b;           // equals 113
c := word(a + b);   // equals 113
d := a + b;         // equals 369
```

OPERATORS

Operators are tokens that trigger some computation when being applied to variables and other objects in an expression.

There are four types of operators in *mikroPascal for 8051*:

- Arithmetic Operators
- Bitwise Operators
- Boolean Operators
- Relational Operators

OPERATORS PRECEDENCE AND ASSOCIATIVITY

There are 4 precedence categories in *mikroPascal for 8051*. Operators in the same category have equal precedence with each other.

Each category has an associativity rule: left-to-right (\rightarrow), or right-to-left (\leftarrow). In the absence of parentheses, these rules resolve the grouping of expressions with operators of equal precedence.

Precedence	Operands	Operators	Associativity
4	1	@ not + -	\leftarrow
3	2	* / div mod and shl shr	\rightarrow
2	2	+ - or xor	\rightarrow
1	2	= <> < > <= >=	\rightarrow

ARITHMETIC OPERATORS

Arithmetic operators are used to perform mathematical computations. They have numerical operands and return numerical results. Since the `char` operators are technically `bytes`, they can be also used as unsigned operands in arithmetic operations.

All arithmetic operators associate from left to right.

Operator	Operation	Operands	Result
<code>+</code>	addition	<code>byte, short, word, integer, longint, dword, real</code>	<code>byte, short, word, integer, longint, dword, real</code>
<code>-</code>	subtraction	<code>byte, short, word, integer, longint, dword, real</code>	<code>byte, short, word, integer, longint, dword, real</code>
<code>*</code>	multiplication	<code>byte, short, word, integer, longint, dword, real</code>	<code>word, integer, longint, dword, real</code>
<code>/</code>	division, floating-point	<code>byte, short, word, integer, longint, dword, real</code>	<code>real</code>
<code>div</code>	division, rounds down to nearest integer	<code>byte, short, word, integer, longint, dword</code>	<code>byte, short, word, integer, longint, dword</code>
<code>mod</code>	modulus, returns the remainder of integer division (cannot be used with floating points)	<code>byte, short, word, integer, longint, dword</code>	<code>byte, short, word, integer, longint, dword</code>

Division by Zero

If 0 (zero) is used explicitly as the second operand (i.e. `x div 0`), the compiler will report an error and will not generate code.

But in case of implicit division by zero: `x div y`, where `y` is 0 (zero), the result will be the maximum integer (i.e. `255`, if the result is `byte` type; `65536`, if the result is `word` type, etc.).

Unary Arithmetic Operators

Operator `-` can be used as a prefix unary operator to change sign of a signed value. Unary prefix operator `+` can be used, but it doesn't affect data.

For example:

```
b := -a;
```

RELATIONAL OPERATORS

Use relational operators to test equality or inequality of expressions. All relational operators return `TRUE` or `FALSE`.

Operator	Operation
<code>=</code>	equal
<code><></code>	not equal
<code>></code>	greater than
<code><</code>	less than
<code>>=</code>	greater than or equal
<code><=</code>	less than or equal

All relational operators associate from left to right.

Relational Operators in Expressions

Precedence of arithmetic and relational operators is designated in such a way to allow complex expressions without parentheses to have expected meaning:

```
a + 5 >= c - 1.0 / e    // ? (a + 5) >= (c - (1.0 / e))
```

BITWISE OPERATORS

Use bitwise operators to modify individual bits of numerical operands. Operands need to be either both signed or both unsigned.

Bitwise operators associate from left to right. The only exception is the bitwise complement operator `not` which associates from right to left.

Bitwise Operators Overview

Operator	Operation
<code>and</code>	bitwise AND; compares pairs of bits and generates a 1 result if both bits are 1, otherwise it returns 0
<code>or</code>	bitwise (inclusive) OR; compares pairs of bits and generates a 1 result if either or both bits are 1, otherwise it returns 0
<code>xor</code>	bitwise exclusive OR (XOR); compares pairs of bits and generates a 1 result if the bits are complementary, otherwise it returns 0
<code>not</code>	bitwise complement (unary); inverts each bit
<code>shl</code>	bitwise shift left; moves the bits to the left, discards the far left bit and assigns 0 to the right most bit.
<code>shr</code>	bitwise shift right; moves the bits to the right, discards the far right bit and if unsigned assigns 0 to the left most bit, otherwise sign extends

Logical Operations on Bit Level

<code>and</code>	0	1
0	0	0
1	0	1

<code>or</code>	0	1
0	0	1
1	1	1

<code>xor</code>	0	1
0	0	1
1	1	0

<code>not</code>	0	1
	1	0

Bitwise operators `and`, `or`, and `xor` perform logical operations on the appropriate pairs of bits of their operands. `not` operator complements each bit of its operand. For example:

```

$1234 and $5678           // equals $1230

{ because ..

$1234 : 0001 0010 0011 0100
$5678 : 0101 0110 0111 1000
-----
and   : 0001 0010 0011 0000

.. that is, $1230 }// Similarly:

$1234 or  $5678           // equals $567C
$1234 xor $5678           // equals $444C
not $1234                 // equals $EDCB

```

Unsigned and Conversions

If a number is converted from less complex to more complex data type, the upper bytes are filled with zeroes. If a number is converted from more complex to less complex data type, the data is simply truncated (the upper bytes are lost).

For example:

```

var a : byte; b : word;
...
  a := $AA;
  b := $F0F0;
  b := b and a;
  { a is extended with zeroes; b becomes $00A0 }

```

Signed and Conversions

If number is converted from less complex data type to more complex, upper bytes are filled with ones if sign bit is 1 (number is negative); upper bytes are filled with zeroes if sign bit is 0 (number is positive). If number is converted from more complex data type to less complex, data is simply truncated (upper bytes are lost).

For example:

```

var a : byte; b : word;
...
  a := -12;
  b := $70FF;
  b := b and a;

  { a is sign extended, with the upper byte equal to $FF;
    b becomes $70F4 }

```

Bitwise Shift Operators

Binary operators `shl` and `shr` move the bits of the left operand by a number of positions specified by the right operand, to the left or right, respectively. Right operand has to be positive and less than 255.

With shift left (`shl`), left most bits are discarded, and “new” bits on the right are assigned zeroes. Thus, shifting unsigned operand to the left by n positions is equivalent to multiplying it by 2^n if all discarded bits are zero. This is also true for signed operands if all discarded bits are equal to the sign bit.

With shift right (`shr`), right most bits are discarded, and the “freed” bits on the left are assigned zeroes (in case of unsigned operand) or the value of the sign bit (in case of signed operand). Shifting operand to the right by n positions is equivalent to dividing it by 2^n .

BOOLEAN OPERATORS

Although *mikroPascal for 8051* does not support `boolean` type, you have Boolean operators at your disposal for building complex conditional expressions. These operators conform to standard Boolean logic and return either `TRUE` (all ones) or `FALSE` (zero):

Operator	Operation
<code>and</code>	logical AND
<code>or</code>	logical OR
<code>xor</code>	logical exclusive OR (XOR)
<code>not</code>	logical negation

Boolean operators associate from left to right. Negation operator `not` associates from right to left.

EXPRESSIONS

An expression is a sequence of operators, operands and punctuators that returns a value.

The primary expressions include: literals, constants, variables and function calls. More complex expressions can be created from primary expressions by using operators. Formally, expressions are defined recursively: subexpressions can be nested up to the limits of memory.

Expressions are evaluated according to certain conversion, grouping, associativity and precedence rules which depend on the operators in use, presence of parentheses and data types of the operands. The precedence and associativity of the operators are summarized in Operator Precedence and Associativity. The way operands and subexpressions are grouped does not necessarily specify the actual order in which they are evaluated by *mikroPascal for 8051*.

STATEMENTS

Statements define algorithmic actions within a program. Each statement needs to be terminated with a semicolon (;). In the absence of specific jump and selection statements, statements are executed sequentially in the order of appearance in the source code.

The most simple statements are assignments, procedure calls and jump statements. These can be combined to form loops, branches and other structured statements.

Refer to:

- Assignment Statements
- Compound Statements (Blocks)
- Conditional Statements
- Iteration Statements (Loops)
- Jump Statements

- asm Statement

ASSIGNMENT STATEMENTS

Assignment statements have the form:

```
variable := expression;
```

The statement evaluates `expression` and assigns its value to `variable`. All the rules of implicit conversion are applied. `Variable` can be any declared variable or array element, and `expression` can be any expression.

Do not confuse the assignment with relational operator `=` which tests for equality. Also note that, although similar, the construction is not related to the declaration of constants.

COMPOUND STATEMENTS (BLOCKS)

Compound statement, or block, is a list of statements enclosed by keywords `begin` and `end`:

```
begin
    statements
end;
```

Syntactically, a block is considered to be a single statement which is allowed to be used when Pascal syntax requires a single statement. Blocks can be nested up to the limits of memory.

For example, the `while` loop expects one statement in its body, so we can pass it a compound statement:

```
while i < n do
    begin
        temp := a[ i ];
        a[ i ] := b[ i ];
        b[ i ] := temp;
        i := i + 1;
    end;
```

CONDITIONAL STATEMENTS

Conditional or selection statements select one of alternative courses of action by testing certain values. There are two types of selection statements:

- if
- case

If Statement

Use if to implement a conditional statement. The syntax of if statement has the form:

```
if expression then statement1 [ else statement2]
```

If `expression` evaluates to true then `statement1` executes. If `expression` is false then `statement2` executes. The `expression` must convert to a boolean type; otherwise, the condition is ill-formed. The `else` keyword with an alternate statement (`statement2`) is optional.

There should never be a semicolon before the keyword else.

Nested if statements

Nested if statements require additional attention. A general rule is that the nested conditionals are parsed starting from the innermost conditional, with each `else` bound to the nearest available `if` on its left:

```
if expression1 then  
if expression2 then statement1  
else statement2
```

The compiler treats the construction in this way:

```
if expression1 then  
begin  
    if expression2 then statement1  
    else statement2  
end
```

In order to force the compiler to interpret our example the other way around, we have to write it explicitly:

```
if expression1 then  
begin  
    if expression2 then statement1  
end  
else statement2
```

CASE STATEMENT

Use the case statement to pass control to a specific program branch, based on a certain condition. The case statement consists of a selector expression (a condition) and a list of possible values. The syntax of the case statement is:

```
case selector of
  value_1 : statement_1
  ...
  value_n : statement_n
  [ else default_statement]
end;
```

`selector` is an expression which should evaluate as integral value. `values` can be literals, constants, or expressions, and `statements` can be any statements.

The `else` clause is optional. If using the `else` branch, note that there should never be a semicolon before the keyword `else`.

First, the `selector` expression (condition) is evaluated. Afterwards the case statement compares it against all available `values`. If the match is found, the `statement` following the match evaluates, and the case statement terminates. In case there are multiple matches, the first matching statement will be executed. If none of `values` matches `selector`, then `default_statement` in the else clause (if there is some) is executed.

Here's a simple example of the `case` statement:

```
case operator of
  '*' : result := n1 * n2;
  '/' : result := n1 / n2;
  '+' : result := n1 + n2;
  '-' : result := n1 - n2
else result := 0;
end;
```

Also, you can group values together for a match. Simply separate the items by commas:

```
case reg of
  0:      opmode := 0;
  1,2,3,4: opmode := 1;
  5,6,7:  opmode := 2;
end;
```

In *mikroPascal for 8051*, `values` in the `case` statement can be variables too:

```
case byte_variable of

    byte_var1: opmode := 0; // this will be compiled correctly

    byte_var2:
        opmode := 1; // avoid this case, compiler will parse
                    // a variable followed by colon sign as
label

    byte_var3: //          adding a comment solves the parsing
problem        opmode := 2;

end;
```

Nested Case statement

Note that the `case` statements can be nested – `values` are then assigned to the innermost enclosing `case` statement.

ITERATION STATEMENTS

Iteration statements let you loop a set of statements. There are three forms of iteration statements in *mikroPascal for 8051*:

- for
- while
- repeat

You can use the statements `break` and `continue` to control the flow of a loop statement. `break` terminates the statement in which it occurs, while `continue` begins executing the next iteration of the sequence.

FOR STATEMENT

The `for` statement implements an iterative loop and requires you to specify the number of iterations. The syntax of the `for` statement is:

```
for counter := initial_value to final_value do statement
// or
for counter := initial_value downto final_value do statement
```

`counter` is a variable which increments (or decrements if you use `downto`) with each iteration of the loop. Before the first iteration, `counter` is set to `initial_value` and will increment (or decrement) until it reaches `final_value`. With each iteration, `statement` will be executed.

`initial_value` and `final_value` should be expressions compatible with `counter`; `statement` can be any statement that does not change the value of `counter`.

Here is an example of calculating scalar product of two vectors, `a` and `b`, of length `n`, using the `for` statement:

```
s := 0;
for i := 0 to n-1 do
  s := s + a[i] * b[i];
```

Endless Loop

The `for` statement results in an endless loop if `final_value` equals or exceeds the range of the `counter`'s type.

More legible way to create an endless loop in Pascal is to use the statement `while TRUE do`.

WHILE STATEMENT

Use the `while` keyword to conditionally iterate a statement. The syntax of the `while` statement is:

```
while expression do statement
```

`statement` is executed repeatedly as long as `expression` evaluates true. The test takes place before the `statement` is executed. Thus, if `expression` evaluates false on the first pass, the loop does not execute.

Here is an example of calculating scalar product of two vectors, using the `while` statement:

```
s := 0; i := 0;
while i < n do
begin
  s := s + a[i] * b[i];
  i := i + 1;
end;
```

Probably the easiest way to create an endless loop is to use the statement:

```
while TRUE do ...;
```

REPEAT STATEMENT

The repeat statement executes until the condition becomes false. The syntax of the repeat statement is:

```
repeat statement until expression
```

`statement` is executed repeatedly as long as `expression` evaluates true. The `expression` is evaluated after each iteration, so the loop will execute `statement` at least once.

Here is an example of calculating scalar product of two vectors, using the repeat statement:

```
s := 0; i := 0;
...
repeat
  begin
    s := s + a[ i ] * b[ i ];
    i := i + 1;
  end;
until i = n;
```

JUMP STATEMENTS

A jump statement, when executed, transfers control unconditionally. There are four such statements in *mikroPascal for 8051*:

- break
- continue
- exit
- goto

BREAK AND CONTINUE STATEMENTS

Break Statement

Sometimes, you might need to stop the loop from within its body. Use the `break` statement within loops to pass control to the first statement following the innermost loop (`for`, `while`, or `repeat` block).

For example:

```
Lcd_Out(1,1,'Insert CF card');

// Wait for CF card to be plugged; refresh every second
while TRUE do
begin
    if Cf_Detect() = 1 then break;
    Delay_ms(1000);
end;

// Now we can work with CF card ...
Lcd_Out(1,1,'Card detected  ');
```

Continue Statement

You can use the `continue` statement within loops to “skip the cycle”:

- `continue` statement in `for` loop moves program counter to the line with keyword `for`
- `continue` statement in `while` loop moves program counter to the line with loop condition (top of the loop),
- `continue` statement in `repeat` loop moves program counter to the line with loop condition (bottom of the loop).

```
// continue jumps here
for i := ... do
  begin
    ...
    continue;
    ...
  end;

// continue jumps here
while condition do
  begin
    ...
    continue;
    ...
  end;

repeat
  begin
    ...
    continue;
    ...
  here
until condition;
```

EXIT STATEMENT

The `exit` statement allows you to break out of a routine (function or procedure). It passes the control to the first statement following the routine call.

Here is a simple example:

```
procedure Procl();
var error: byte;
begin
  ... // we're doing something here
  if error = TRUE then exit;
  ... // some code, which won't be executed if error is true
end;
```

Note: If breaking out of a function, return value will be the value of the local variable `result` at the moment of exit.

GOTO STATEMENT

Use the `goto` statement to unconditionally jump to a local label — for more information, refer to Labels. Syntax of `goto` statement is:

```
goto label_name;
```

This will transfer control to the location of a local label specified by `label_name`. The `goto` line can come before or after the label.

The label declaration, marked statement and `goto` statement must belong to the same block. Hence it is not possible to jump into or out of a procedure or function.

You can use `goto` to break out from any level of nested control structures. Never jump into a loop or other structured statement, since this can have unpredictable effects.

Use of `goto` statement is generally discouraged as practically every algorithm can be realized without it, resulting in legible structured programs. One possible application of `goto` statement is breaking out from deeply nested control structures:

```
for (...) do
  begin
    for (...) do
      begin
        ...
        if (disaster) then goto Error;
        ...
      end;
    end;
  .
  .
  .
Error: // error handling code
```

asm STATEMENT

mikroPascal for 8051 allows embedding assembly in the source code by means of the `asm` statement. Note that you cannot use numerals as absolute addresses for register variables in assembly instructions. You may use symbolic names instead (listing will display these names as well as addresses).

You can group assembly instructions with the `asm` keyword:

```
asm
    block of assembly instructions
end;
```

If you plan to use a certain Pascal variable in embedded assembly only, be sure to at least initialize it (assign it initial value) in Pascal code; otherwise, the linker will issue an error. This is not applied to predefined globals such as `P0`.

For example, the following code will not be compiled because the linker won't be able to recognize the variable `myvar`:

```
program test;
var myvar : word;
begin

    asm
        MOV     #10, W0
        MOV     W0, _myvar
    end;
end.
```

Adding the following line (or similar one) above the `asm` block would let linker know that variable is used:

```
myvar := 20;
```

DIRECTIVES

Directives are words of special significance which provide additional functionality regarding compilation and output.

The following directives are available for use:

- Compiler directives for conditional compilation,
- Linker directives for object distribution in memory.

COMPILER DIRECTIVES

mikroPascal for 8051 treats comments beginning with a “\$” immediately following an opening brace as a compiler directive; for example, { \$ELSE} . The compiler directives are not case sensitive.

You can use a conditional compilation to select particular sections of code to compile, while excluding other sections. All compiler directives must be completed in the source file in which they have begun.

Directives \$DEFINE and \$UNDEFINE

Use directive `$DEFINE` to define a conditional compiler constant (“flag”). You can use any identifier for a flag, with no limitations. No conflicts with program identifiers are possible because the flags have a separate name space. Only one flag can be set per directive.

For example:

```
{ $DEFINE Extended_format}
```

Use `$UNDEFINE` to undefine (“clear”) previously defined flag.

Note: Pascal does not support macros; directives `$DEFINE` and `$UNDEFINE` do not create/destroy macros. They only provide flags for directive `$IFDEF` to check against.

Directives `$IFDEF..$ELSE`

Conditional compilation is carried out by the `$IFDEF` directive. `$IFDEF` tests whether a flag is currently defined or not, i.e. whether a previous `$DEFINE` directive has been processed for that flag and is still in force.

Directive `$IFDEF` is terminated with the `$ENDIF` directive, and can have an optional `$ELSE` clause:

```
{ $IFDEF flag}
  <block of code>
{ $ELSE}
  <alternate block of code>
{ $ENDIF}
```

First, `$IFDEF` checks if flag is defined by means of `$DEFINE`. If so, only `<block of code>` will be compiled. Otherwise, `<alternate block of code>` will be compiled. `$ENDIF` ends the conditional sequence. The result of the preceding scenario is that only one section of code (possibly empty) is passed on for further processing.

The processed section can contain further conditional clauses, nested to any depth; each `$IFDEF` must be matched with a closing `$ENDIF`.

Here is an example:

```
// Uncomment the appropriate flag for your application:
//{ $DEFINE resolution10}
//{ $DEFINE resolution12}

{ $IFDEF resolution10}
  // <code specific to 10-bit resolution>
{ $ELSE}
  { $IFDEF resolution12}
    // <code specific to 12-bit resolution>
  { $ELSE}
    // <default code>
  { $ENDIF}
{ $ENDIF}
```

Include Directive `$I`

The `$I` parameter directive instructs *mikroPascal for 8051* to include the named text file in the compilation. In effect, the file is inserted in the compiled text right after the `{ $I filename}` directive. If filename does not specify a directory path, then, in addition to searching for the file in the same directory as the current unit, *mikroPascal for 8051* will search for file in order specified by the search paths.

To specify a filename that includes a space, surround the file name with quotation marks: `{ $I "My file"}`.

There is one restriction to the use of include files: An include file can't be specified in the middle of a statement part. In fact, all statements between the begin and end of a statement part must exist in the same source file.

Predefined Flags

The compiler sets directives upon completion of project settings, so the user doesn't need to define certain flags.

Here is an example:

```
{ $IFDEF AT89S8253} // If AT89S8253 MCU is selected
{ $IFDEF P30}      AT89S8253 and P30 flags will be automatically
defined
```

LINKER DIRECTIVES

mikroPascal for 8051 uses internal algorithm to distribute objects within memory. If you need to have a variable or a routine at the specific predefined address, use the linker directives `absolute` and `org`.

Note: You must specify an even address when using the linker directives.

Directive `absolute`

Directive `absolute` specifies the starting address in RAM for a variable. If the variable spans more than 1 word (16-bit), the higher words will be stored at the consecutive locations.

Directive `absolute` is appended to the declaration of a variable:

```
var x : word; absolute $32;
// Variable x will occupy 1 word (16 bits) at address $32

    y : longint; absolute $34;
// Variable y will occupy 2 words at addresses $34 and $36
```

Be careful when using the `absolute` directive because you may overlap two variables by accident. For example:

```
var i : word; absolute $42;
// Variable i will occupy 1 word at address $42;

    jj : longint; absolute $40;
// Variable will occupy 2 words at $40 and $42; thus,
// changing i changes jj at the same time and vice versa
```

Note: You must specify an even address when using the `absolute` directive.

Directive `org`

Directive `org` specifies the starting address of a routine in ROM. It is appended to the declaration of a routine. For example:

```
procedure proc(par : byte); org $200;
begin
// Procedure will start at address $200;
...
end;
```

`org` directive can be used with `main` routine too. For example:

```
program Led_Blinking;

procedure some_proc();
begin
...
end;

org 0x800; // main procedure starts at 0x800
begin
ADPCFG := $FFFF;
TRISB := $0000;

while TRUE do
begin
LATB := $0000;
Delay_ms(500);
LATB := $FFFF;
Delay_ms(500);
end;
end.
```

Note: You must specify an even address when using the `org` directive.

CHAPTER



mikroPascal for 8051 Libraries

mikroPascal for 8051 provides a set of libraries which simplify the initialization and use of 8051 compliant MCUs and their modules:

Use Library manager to include *mikroPascal for 8051* Libraries in you project.

Hardware 8051-specific Libraries

- CANSPI Library
- EEPROM Library
- Graphic LCD Library
- Keypad Library
- LCD Library
- Manchester Code Library
- OneWire Library
- Port Expander Library
- PS/2 Library
- RS-485 Library
- Software I2C Library
- Software SPI Library
- Software UART Library
- Sound Library
- SPI Library
- SPI Ethernet Library
- SPI Graphic LCD Library
- SPI LCD Library
- SPI LCD8 Library
- SPI T6963C Graphic LCD Library
- T6963C Graphic LCD Library
- UART Library

Miscellaneous Libraries

- Button Library
- Conversions Library
- Math Library
- String Library
- Time Library
- Trigonometry Library

See also Built-in Routines.

LIBRARY DEPENDENCIES

Certain libraries use (depend on) function and/or variables, constants defined in other libraries.

Image below shows clear representation about these dependencies.

For example, SPI_Glcd uses Glcd_Fonts and Port_Expander library which uses SPI library.

This means that if you check SPI_Glcd library in Library manager, all libraries on which it depends will be checked too.

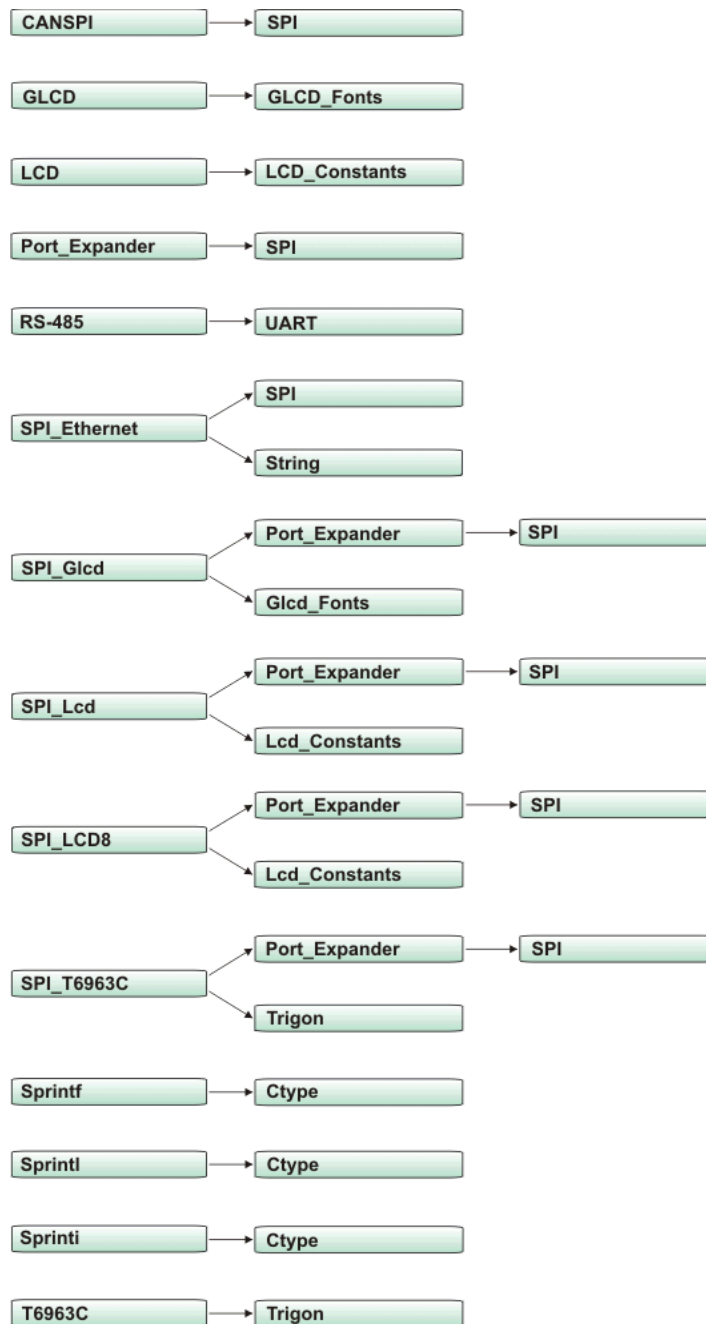

Related topics: Library manager, 8051 Libraries

CANSPI LIBRARY

The SPI module is available with a number of the 8051 compliant MCUs. The *mikroPascal for 8051* provides a library (driver) for working with mikroElektronika's CANSPI Add-on boards (with MCP2515 or MCP2510) via SPI interface.

The CAN is a very robust protocol that has error detection and signalization, self-checking and fault confinement. Faulty CAN data and remote frames are re-transmitted automatically, similar to the Ethernet.

Data transfer rates depend on distance. For example, 1 Mbit/s can be achieved at network lengths below 40m while 250 Kbit/s can be achieved at network lengths below 250m. The greater distance the lower maximum bitrate that can be achieved. The lowest bitrate defined by the standard is 200Kbit/s. Cables used are shielded twisted pairs.

CAN supports two message formats:

- Standard format, with 11 identifier bits and
- Extended format, with 29 identifier bits

Note:

- Consult the CAN standard about CAN bus termination resistance.
- An effective CANSPI communication speed depends on SPI and certainly is slower than "real" CAN.
- CANSPI module refers to mikroElektronika's CANSPI Add-on board connected to SPI module of MCU.

External dependencies of CANSPI Library

The following variables must be defined in all projects using CANSPI Library:	Description:	Example :
<code>var CanSpi_CS: sbit; external;</code>	Chip Select line.	<code>var CanSpi_CS: sbit at P1.B0;</code>
<code>var CanSpi_RST: sbit; external;</code>	Reset line.	<code>var CanSpi_Rst: sbit at P1.B2;</code>

Library Routines

- CANSPISetOperationMode
- CANSPIGetOperationMode
- CANSPIInitialize
- CANSPISetBaudRate
- CANSPISetMask
- CANSPISetFilter
- CANSPIread
- CANSPIWrite

The following routines are for an internal use by the library only:

- RegsToCANSPIID
- CANSPIIDToRegs

Be sure to check CANSPI constants necessary for using some of the functions.

CANSPISetOperationMode

Prototype	<code>procedure CANSPISetOperationMode(mode: byte; WAIT: byte);</code>
Returns	Nothing.
Description	<p>Sets the CANSPI module to requested mode.</p> <p>Parameters :</p> <ul style="list-style-type: none"> - <code>mode</code>: CANSPI module operation mode. Valid values: <code>CANSPI_OP_MODE</code> constants (see CANSPI constants). - <code>WAIT</code>: CANSPI mode switching verification request. If <code>WAIT = 0</code>, the call is non-blocking. The function does not verify if the CANSPI module is switched to requested mode or not. Caller must use <code>CANSPIGetOperationMode</code> to verify correct operation mode before performing mode specific operation. If <code>WAIT != 0</code>, the call is blocking – the function won't "return" until the requested mode is set.
Requires	<p>The CANSPI routines are supported only by MCUs with the SPI module.</p> <p>MCU has to be properly connected to mikroElektronika's CANSPI Extra Board or similar hardware. See connection example at the bottom of this page.</p>
Example	<pre>// set the CANSPI module into configuration mode (wait inside CANSPISetOperationMode until this mode is set) CANSPISetOperationMode(CANSPI_MODE_CONFIG, 0xFF);</pre>

CANSPIGetOperationMode

Prototype	<code>function CANSPIGetOperationMode(): byte;</code>
Returns	Current operation mode.
Description	<p>The function returns current operation mode of the CANSPI module. Check <code>CANSPI_OP_MODE</code> constants (see CANSPI constants) or device datasheet for operation mode codes.</p>
Requires	<p>The CANSPI routines are supported only by MCUs with the SPI module.</p> <p>MCU has to be properly connected to mikroElektronika's CANSPI Extra Board or similar hardware. See connection example at the bottom of this page.</p>
Example	<pre>// check whether the CANSPI module is in Normal mode and if it is do something. if (CANSPIGetOperationMode() = CANSPI_MODE_NORMAL) then begin ... end;</pre>

CANSPIInitialize

Prototype	<code>procedure CANSPIInitialize(SJW: byte; BRP: byte; PHSEG1: byte; PHSEG2: byte; PROPSEG: byte; CAN_CONFIG_FLAGS: byte);</code>
Returns	Nothing.
Description	<p>Initializes the CANSPI module.</p> <p>Stand-Alone CAN controller in the CANSPI module is set to:</p> <ul style="list-style-type: none"> - Disable CAN capture - Continue CAN operation in Idle mode - Do not abort pending transmissions - Fcan clock: 4*Tcy (Fosc) - Baud rate is set according to given parameters - CAN mode: Normal - Filter and mask registers IDs are set to zero - Filter and mask message frame type is set according to <code>CAN_CONFIG_FLAGS</code> value <p><code>SAM</code>, <code>SEG2PHTS</code>, <code>WAKFIL</code> and <code>DBEN</code> bits are set according to <code>CAN_CONFIG_FLAGS</code> value.</p> <p>Parameters:</p> <ul style="list-style-type: none"> - <code>SJW</code> as defined in CAN controller's datasheet - <code>BRP</code> as defined in CAN controller's datasheet - <code>PHSEG1</code> as defined in CAN controller's datasheet - <code>PHSEG2</code> as defined in CAN controller's datasheet - <code>PROPSEG</code> as defined in CAN controller's datasheet - <code>CAN_CONFIG_FLAGS</code> is formed from predefined constants (see CANSPI constants)
Requires	<p><code>CanSpi_CS</code> and <code>CanSpi_Rst</code> variables must be defined before using this function.</p> <p>The CANSPI routines are supported only by MCUs with the SPI module.</p> <p>The SPI module needs to be initialized. See the <code>Spi_Init</code> and <code>Spi_Init_Advanced</code> routines.</p> <p>MCU has to be properly connected to mikroElektronika's CANSPI Extra Board or similar hardware. See connection example at the bottom of this page.</p>

Example

```
// initialize the CANSPI module with the appropriate baud rate
and message acceptance flags along with the sampling rules
var Can_Init_Flags: byte;
...
Can_Init_Flags := CAN_CONFIG_SAMPLE_THRICE and // form value
to be used
                CAN_CONFIG_PHSEG2_PRG_ON and // with
CANSPIInitialize
                CAN_CONFIG_XTD_MSG           and
                CAN_CONFIG_DBL_BUFFER_ON and
                CAN_CONFIG_VALID_XTD_MSG;
...
Spi_Init(); // initialize
SPI module
CANSPIInitialize(1,3,3,3,1,Can_Init_Flags); // initialize
external CANSPI module
```

CANSPISetBaudRate

Prototype	procedure CANSPISetBaudRate(SJW: byte; BRP: byte; PHSEG1: byte; PHSEG2: byte; PROPSEG: byte; CAN_CONFIG_FLAGS: byte);
Returns	Nothing.
Description	<p>Sets the CANSPI module baud rate. Due to complexity of the CAN protocol, you can not simply force a bps value. Instead, use this function when the CANSPI module is in Config mode.</p> <p><code>SAM</code>, <code>SEG2PHTS</code> and <code>WAKFIL</code> bits are set according to <code>CAN_CONFIG_FLAGS</code> value. Refer to datasheet for details.</p> <p>Parameters:</p> <ul style="list-style-type: none"> - <code>SJW</code> as defined in CAN controller's datasheet - <code>BRP</code> as defined in CAN controller's datasheet - <code>PHSEG1</code> as defined in CAN controller's datasheet - <code>PHSEG2</code> as defined in CAN controller's datasheet - <code>PROPSEG</code> as defined in CAN controller's datasheet - <code>CAN_CONFIG_FLAGS</code> is formed from predefined constants (see CANSPI constants)
Requires	<p>The CANSPI module must be in Config mode, otherwise the function will be ignored. See CANSPISetOperationMode.</p> <p>The CANSPI routines are supported only by MCUs with the SPI module.</p> <p>MCU has to be properly connected to mikroElektronika's CANSPI Extra Board or similar hardware. See connection example at the bottom of this page.</p>
Example	<pre>// set required baud rate and sampling rules var can_config_flags: byte; ... CANSPISetOperationMode(CANSPI_MODE_CONFIG,0xFF); // set CONFIGURATION mode (CANSPI module must be in config mode for baud rate settings) can_config_flags := CANSPI_CONFIG_SAMPLE_THRICE and CANSPI_CONFIG_PHSEG2_PRG_ON and CANSPI_CONFIG_STD_MSG and CANSPI_CONFIG_DBL_BUFFER_ON and CANSPI_CONFIG_VALID_XTD_MSG and CANSPI_CONFIG_LINE_FILTER_OFF; CANSPISetBaudRate(1, 1, 3, 3, 1, can_config_flags);</pre>

CANSPISetMask

Prototype	<code>procedure CANSPISetMask(CAN_MASK: byte; val: longint; CAN_CONFIG_FLAGS: byte);</code>
Returns	Nothing.
Description	<p>Configures mask for advanced filtering of messages. The parameter value is bit-adjusted to the appropriate mask registers.</p> <p>Parameters:</p> <ul style="list-style-type: none"> - <code>CAN_MASK</code>: CANSPI module mask number. Valid values: <code>CANSPI_MASK</code> constants (see CANSPI constants) - <code>val</code>: mask register value - <code>CAN_CONFIG_FLAGS</code>: selects type of message to filter. Valid values: <ul style="list-style-type: none"> <code>CANSPI_CONFIG_ALL_VALID_MSG,</code> <code>CANSPI_CONFIG_MATCH_MSG_TYPE</code> and <code>CANSPI_CONFIG_STD_MSG,</code> <code>CANSPI_CONFIG_MATCH_MSG_TYPE</code> and <code>CANSPI_CONFIG_XTD_MSG.</code> <p>(see CANSPI constants)</p>
Requires	<p>The CANSPI module must be in Config mode, otherwise the function will be ignored. See <code>CANSPISetOperationMode</code>.</p> <p>The CANSPI routines are supported only by MCUs with the SPI module.</p> <p>MCU has to be properly connected to mikroElektronika's CANSPI Extra Board or similar hardware. See connection example at the bottom of this page.</p>
Example	<pre>// set the appropriate filter mask and message type value CANSPISetOperationMode(CANSPI_MODE_CONFIG,0xFF); // // set CONFIGURATION mode (CANSPI module must be in config mode for // mask settings) // Set all B1 mask bits to 1 (all filtered bits are relevant): // Note that -1 is just a cheaper way to write 0xFFFFFFFF. // Complement will do the trick and fill it up with ones. CANSPISetMask(CANSPI_MASK_B1, -1, CANSPI_CONFIG_MATCH_MSG_TYPE and CANSPI_CONFIG_XTD_MSG);</pre>

CANSPISetFilter

Prototype	<pre>procedure CANSPISetFilter(CAN_FILTER: byte; val: longint; CAN_CONFIG_FLAGS: byte);</pre>
Returns	Nothing.
Description	<p>Configures message filter. The parameter <code>value</code> is bit-adjusted to the appropriate filter registers.</p> <p>Parameters:</p> <ul style="list-style-type: none">- <code>CAN_FILTER</code>: CANSPI module filter number. Valid values: <code>CANSPI_FILTER</code> constants (see CANSPI constants)- <code>val</code>: filter register value- <code>CAN_CONFIG_FLAGS</code>: selects type of message to filter. Valid values: <code>CANSPI_CONFIG_ALL_VALID_MSG,</code> <code>CANSPI_CONFIG_MATCH_MSG_TYPE</code> and <code>CANSPI_CONFIG_STD_MSG,</code> <code>CANSPI_CONFIG_MATCH_MSG_TYPE</code> and <code>CANSPI_CONFIG_XTD_MSG.</code> <p>(see CANSPI constants)</p>
Requires	<p>The CANSPI module must be in Config mode, otherwise the function will be ignored. See <code>CANSPISetOperationMode</code>.</p> <p>The CANSPI routines are supported only by MCUs with the SPI module.</p> <p>MCU has to be properly connected to mikroElektronika's CANSPI Extra Board or similar hardware. See connection example at the bottom of this page.</p>
Example	<pre>// set the appropriate filter value and message type CANSPISetOperationMode(CANSPI_MODE_CONFIG,0xFF); // set CONFIGURATION mode (CANSPI module must be in config mode for filter settings) /* Set id of filter B1_F1 to 3: */ CANSPISetFilter(CANSPI_FILTER_B1_F1, 3, CANSPI_CONFIG_XTD_MSG);</pre>

CANSPIRead

Prototype	<code>function CANSPIRead(var id: longint; var rd_data: array[20] of byte; data_len: byte; CAN_RX_MSG_FLAGS: byte): byte;</code>
Returns	<ul style="list-style-type: none"> - 0 if nothing is received - 0xFF if one of the Receive Buffers is full (message received)
Description	<p>If at least one full Receive Buffer is found, it will be processed in the following way:</p> <ul style="list-style-type: none"> - Message ID is retrieved and stored to location provided by the <code>id</code> parameter - Message data is retrieved and stored to a buffer provided by the <code>rd_data</code> parameter - Message length is retrieved and stored to location provided by the <code>data_len</code> parameter - Message flags are retrieved and stored to location provided by the <code>CAN_RX_MSG_FLAGS</code> parameter <p>Parameters:</p> <ul style="list-style-type: none"> - <code>id</code>: message identifier storage address - <code>rd_data</code>: data buffer (an array of bytes up to 8 bytes in length) - <code>data_len</code>: data length storage address. - <code>CAN_RX_MSG_FLAGS</code>: message flags storage address
Requires	<p>The CANSPI module must be in a mode in which receiving is possible. See CANSPISetOperationMode.</p> <p>The CANSPI routines are supported only by MCUs with the SPI module.</p> <p>MCU has to be properly connected to mikroElektronika's CANSPI Extra Board or similar hardware. See connection example at the bottom of this page.</p>
Example	<pre>// check the CANSPI module for received messages. If any was // received do something. var msg_rcvd, rx_flags, data_len: byte; rd_data: array[8] of byte; msg_id: longint; ... CANSPISetOperationMode(CANSPI_MODE_NORMAL,0xFF); // set NORMAL mode (CANSPI module must be in mode in which // receive is possible) ... rx_flags := 0; // clear message flags if (msg_rcvd = CANSPIRead(msg_id, rd_data, data_len, rx_flags) begin ... end;</pre>

CANSPIWrite

Prototype	<code>function CANSPIWrite(id: longint; var wr_data: array[20] of byte; data_len: byte; CAN_TX_MSG_FLAGS: byte): byte;</code>
Returns	<ul style="list-style-type: none"> - 0 if all Transmit Buffers are busy - 0xFF if at least one Transmit Buffer is available
Description	<p>If at least one empty Transmit Buffer is found, the function sends message in the queue for transmission.</p> <p>Parameters:</p> <ul style="list-style-type: none"> - <code>id</code>: CAN message identifier. Valid values: 11 or 29 bit values, depending on message type (standard or extended) - <code>wr_data</code>: data to be sent (an array of bytes up to 8 bytes in length) - <code>data_len</code>: data length. Valid values: 1 to 8 - <code>CAN_RX_MSG_FLAGS</code>: message flags
Requires	<p>The CANSPI module must be in mode in which transmission is possible. See CANSPISetOperationMode.</p> <p>The CANSPI routines are supported only by MCUs with the SPI module.</p> <p>MCU has to be properly connected to mikroElektronika's CANSPI Extra Board or similar hardware. See connection example at the bottom of this page.</p>
Example	<pre>// send message extended CAN message with the appropriate ID and data var tx_flags: byte; rd_data: array[8] of byte; msg_id: longint; ... CANSPISetOperationMode(CAN_MODE_NORMAL, 0xFF); // set NORMAL mode (CANSPI must be in mode in which transmission is possible) tx_flags := CANSPI_TX_PRIORITY_0 ands CANSPI_TX_XTD_FRAME; // set message flags CANSPIWrite(msg_id, rd_data, 2, tx_flags);</pre>

CANSPI Constants

There is a number of constants predefined in the CANSPI library. You need to be familiar with them in order to be able to use the library effectively. Check the example at the end of the chapter.

CANSPI_OP_MODE

The CANSPI_OP_MODE constants define CANSPI operation mode. Function CANSPISetOperationMode expects one of these as it's argument:

```
const
    CANSPI_MODE_BITS      = 0xE0;    // Use this to access opmode bits
    CANSPI_MODE_NORMAL    = 0x00;
    CANSPI_MODE_SLEEP     = 0x20;
    CANSPI_MODE_LOOP      = 0x40;
    CANSPI_MODE_LISTEN    = 0x60;
    CANSPI_MODE_CONFIG    = 0x80;
```

CANSPI_CONFIG_FLAGS

The CANSPI_CONFIG_FLAGS constants define flags related to the CANSPI module configuration. The functions CANSPIInitialize, CANSPISetBaudRate, CANSPISetMask and CANSPISetFilter expect one of these (or a bitwise combination) as their argument:

```
const
    CANSPI_CONFIG_DEFAULT      = 0xFF;    // 11111111

    CANSPI_CONFIG_PHSEG2_PRG_BIT = 0x01;
    CANSPI_CONFIG_PHSEG2_PRG_ON  = 0xFF;    // XXXXXXX1
    CANSPI_CONFIG_PHSEG2_PRG_OFF = 0xFE;    // XXXXXXX0

    CANSPI_CONFIG_LINE_FILTER_BIT = 0x02;
    CANSPI_CONFIG_LINE_FILTER_ON  = 0xFF;    // XXXXXX1X
    CANSPI_CONFIG_LINE_FILTER_OFF = 0xFD;    // XXXXXX0X

    CANSPI_CONFIG_SAMPLE_BIT      = 0x04;
    CANSPI_CONFIG_SAMPLE_ONCE     = 0xFF;    // XXXXX1XX
    CANSPI_CONFIG_SAMPLE_THRICE   = 0xFB;    // XXXXX0XX

    CANSPI_CONFIG_MSG_TYPE_BIT    = 0x08;
    CANSPI_CONFIG_STD_MSG         = 0xFF;    // XXXX1XXX
    CANSPI_CONFIG_XTD_MSG        = 0xF7;    // XXXX0XXX
```

```

CANSPI_CONFIG_DBL_BUFFER_BIT   = 0x10;
CANSPI_CONFIG_DBL_BUFFER_ON    = 0xFF;    // XXX1XXXX
CANSPI_CONFIG_DBL_BUFFER_OFF   = 0xEF;    // XXX0XXXX

CANSPI_CONFIG_MSG_BITS         = 0x60;
CANSPI_CONFIG_ALL_MSG          = 0xFF;    // X11XXXXX
CANSPI_CONFIG_VALID_XTD_MSG    = 0xDF;    // X10XXXXX
CANSPI_CONFIG_VALID_STD_MSG    = 0xBF;    // X01XXXXX
CANSPI_CONFIG_ALL_VALID_MSG    = 0x9F;    // X00XXXXX

```

You may use bitwise `and` to form config byte out of these values. For example:

```

init := CANSPI_CONFIG_SAMPLE_THRICE    and
        CANSPI_CONFIG_PHSEG2_PRG_ON   and
        CANSPI_CONFIG_STD_MSG         and
        CANSPI_CONFIG_DBL_BUFFER_ON   and
        CANSPI_CONFIG_VALID_XTD_MSG   and
        CANSPI_CONFIG_LINE_FILTER_OFF;
...
CANSPIInitialize(1, 1, 3, 3, 1, init);  // initialize CANSPI

```

CANSPI_TX_MSG_FLAGS

CANSPI_TX_MSG_FLAGS are flags related to transmission of a CAN message:

```

const
CANSPI_TX_PRIORITY_BITS = 0x03;
CANSPI_TX_PRIORITY_0    = 0xFC;    // XXXXXX00
CANSPI_TX_PRIORITY_1    = 0xFD;    // XXXXXX01
CANSPI_TX_PRIORITY_2    = 0xFE;    // XXXXXX10
CANSPI_TX_PRIORITY_3    = 0xFF;    // XXXXXX11

CANSPI_TX_FRAME_BIT     = 0x08;
CANSPI_TX_STD_FRAME     = 0xFF;    // XXXXX1XX
CANSPI_TX_XTD_FRAME     = 0xF7;    // XXXXX0XX

CANSPI_TX_RTR_BIT       = 0x40;
CANSPI_TX_NO_RTR_FRAME = 0xFF;    // X1XXXXXX
CANSPI_TX_RTR_FRAME     = 0xBF;    // X0XXXXXX

```

You may use bitwise `and` to adjust the appropriate flags. For example:

```

/* form value to be used as sending message flag: */
send_config := CANSPI_TX_PRIORITY_0    and
               CANSPI_TX_XTD_FRAME     and
               CANSPI_TX_NO_RTR_FRAME;
...
CANSPIWrite(id, data, 1, send_config);

```

CANSPI_RX_MSG_FLAGS

CANSPI_RX_MSG_FLAGS are flags related to reception of CAN message. If a particular bit is set then corresponding meaning is TRUE or else it will be FALSE.

```

const
  CANSPI_RX_FILTER_BITS = 0x07; // Use this to access filter bits
  CANSPI_RX_FILTER_1   = 0x00;
  CANSPI_RX_FILTER_2   = 0x01;
  CANSPI_RX_FILTER_3   = 0x02;
  CANSPI_RX_FILTER_4   = 0x03;
  CANSPI_RX_FILTER_5   = 0x04;
  CANSPI_RX_FILTER_6   = 0x05;

  CANSPI_RX_OVERFLOW   = 0x08; // Set if Overflowed else cleared
  CANSPI_RX_INVALID_MSG = 0x10; // Set if invalid else cleared
  CANSPI_RX_XTD_FRAME  = 0x20; // Set if XTD message else cleared
  CANSPI_RX_RTR_FRAME  = 0x40; // Set if RTR message else cleared
  CANSPI_RX_DBL_BUFFERED = 0x80; // Set if this message was hardware double-buffered

```

You may use bitwise and to adjust the appropriate flags. For example:

```

if (MsgFlag and CANSPI_RX_OVERFLOW <> 0) then
begin
  ...
  // Receiver overflow has occurred.
  // We have lost our previous message.
end;

```

CANSPI_MASK

The CANSPI_MASK constants define mask codes. Function CANSPISetMask expects one of these as it's argument:

```

const
  CANSPI_MASK_B1 = 0;
  CANSPI_MASK_B2 = 1;

```

CANSPI_FILTER

The CANSPI_FILTER constants define filter codes. Functions CANSPISetFilter expects one of these as it's argument:

```

const
  CANSPI_FILTER_B1_F1 = 0;
  CANSPI_FILTER_B1_F2 = 1;
  CANSPI_FILTER_B2_F1 = 2;
  CANSPI_FILTER_B2_F2 = 3;
  CANSPI_FILTER_B2_F3 = 4;
  CANSPI_FILTER_B2_F4 = 5;

```

Library Example

This is a simple demonstration of CANSPI Library routines usage. First node initiates the communication with the second node by sending some data to its address. The second node responds by sending back the data incremented by 1. First node then does the same and sends incremented data back to second node, etc.

Code for the first CANSPI node:

```
program Can_Spi_1st;

var Can_Init_Flags, Can_Send_Flags, Can_Rcv_Flags : byte; // CAN
flags
    Rx_Data_Len : byte;           // Received data length in bytes
    RxTx_Data : array[8] of byte; // CAN rx/tx data buffer
    Msg_Rcvd : byte;             // Reception flag
    Tx_ID, Rx_ID : longint;      // CAN rx and tx ID

// CANSPI module connections
var CanSpi_CS : sbit at P1.B0;
var CanSpi_Rst : sbit at P1.B2;
// End CANSPI module connections

begin

    Can_Init_Flags := 0;           //
    Can_Send_Flags := 0;          // Clear flags
    Can_Rcv_Flags := 0;           //

    Can_Send_Flags := CAN_TX_PRIORITY_0 and // Form value to be used
        CAN_TX_XTD_FRAME and // with CANSPIWrite
        CAN_TX_NO_RTR_FRAME;

    Can_Init_Flags := CAN_CONFIG_SAMPLE_THRICE and // Form
value to be used
        CAN_CONFIG_PHSEG2_PRG_ON and // with
CANSPIInit
        CAN_CONFIG_XTD_MSG and
        CAN_CONFIG_DBL_BUFFER_ON and
        CAN_CONFIG_VALID_XTD_MSG;

    Spi_Init(); // Initialize SPI module
    CANSPIInitialize(1,3,3,3,1,Can_Init_Flags); // Initialize
external CANSPI module

    CANSPISetOperationMode(CAN_MODE_CONFIG,0xFF); // Set CONFIG-
URATION mode
```

```

CANSPISetMask(CAN_MASK_B1,-1,CAN_CONFIG_XTD_MSG);          // Set all
mask1 bits to ones
    CANSPISetMask(CAN_MASK_B2,-1,CAN_CONFIG_XTD_MSG);      //
Set all mask2 bits to ones
    CANSPISetFilter(CAN_FILTER_B2_F4,3,CAN_CONFIG_XTD_MSG); // Set
id of filter B2_F4 to 3

    CANSPISetOperationMode(CAN_MODE_NORMAL,0xFF); // Set NORMAL mode

    RxTx_Data[ 0] := 9;                                     // Set initial data to be sent

    Tx_ID := 12111;                                        // Set transmit ID

    CANSPIWrite(Tx_ID, RxTx_Data, 1, Can_Send_Flags);      //
Send initial message

    while (TRUE) do
        begin
            Msg_Rcvd := CANSPIRead( Rx_ID , RxTx_Data , Rx_Data_Len,
Can_Rcv_Flags); // Receive message
            if ((Rx_ID = 3) and Msg_Rcvd) then
                begin
                    // If message received check id
                    P0 := RxTx_Data[ 0];
                // ID correct, output data at PORT0
                    Inc(RxTx_Data[ 0]);
                // Increment received data
                    Delay_ms(10);
                    CANSPIWrite(Tx_ID, RxTx_Data, 1, Can_Send_Flags);
                // Send incremented data back
                end;
            end;
        end.

```

Code for the second CANSPI node:

```

program Can_Spi_2nd;

var Can_Init_Flags, Can_Send_Flags, Can_Rcv_Flags : byte; // CAN
flags
    Rx_Data_Len : byte; // Received data length in bytes
    RxTx_Data : array[8] of byte; // CAN rx/tx data buffer
    Msg_Rcvd : byte; // Reception flag
    Tx_ID, Rx_ID : longint; // CAN rx and tx ID

    // CANSPI module connections
var CanSpi_CS : sbit at P1.B0;
var CanSpi_Rst : sbit at P1.B2;
    // End CANSPI module connections

```



```

begin

    Can_Init_Flags := 0;           //
    Can_Send_Flags := 0;         // Clear flags
    Can_Rcv_Flags  := 0;         //

    Can_Send_Flags := CAN_TX_PRIORITY_0 and // Form value to be used
                     CAN_TX_XTD_FRAME and //   with CANSPIWrite
                     CAN_TX_NO_RTR_FRAME;

    Can_Init_Flags := CAN_CONFIG_SAMPLE_THRICE and //
    Form value to be used
                     CAN_CONFIG_PHSEG2_PRG_ON and //   with CANSPIInit
                     CAN_CONFIG_XTD_MSG and
                     CAN_CONFIG_DBL_BUFFER_ON and
                     CAN_CONFIG_VALID_XTD_MSG and
                     CAN_CONFIG_LINE_FILTER_OFF;

    Spi_Init();                 // Initialize SPI module
    CANSPIInitialize(1,3,3,3,1,Can_Init_Flags); //
    Initialize CAN-SPI module

    CANSPISetOperationMode(CAN_MODE_CONFIG,0xFF); //
    Set CONFIGURATION mode

    CANSPISetMask(CAN_MASK_B1,-1,CAN_CONFIG_XTD_MSG); //
    Set all mask1 bits to ones
    CANSPISetMask(CAN_MASK_B2,-1,CAN_CONFIG_XTD_MSG); //
    Set all mask2 bits to ones
    CANSPISetFilter(CAN_FILTER_B2_F3,12111,CAN_CONFIG_XTD_MSG); //
    Set id of filter B2_F3 to 12111

    CANSPISetOperationMode(CAN_MODE_NORMAL,0xFF); // Set NORMAL mode

    Tx_ID := 3;                 // Set tx ID

    while (TRUE) do
        begin
            // Endless loop
            Msg_Rcvd := CANSPIRead( Rx_ID , RxTx_Data , Rx_Data_Len,
            Can_Rcv_Flags); // Receive message
            if ((Rx_ID = 12111) and Msg_Rcvd) then
                // If message received check id
                begin
                    P0 := RxTx_Data[0]; // ID correct, output data at PORT0
                    Inc(RxTx_Data[0]); // Increment received data
                    CANSPIWrite(Tx_ID, RxTx_Data, 1, Can_Send_Flags); //
                    Send incremented data back
                end;
            end;
        end;
    end.

```

HW Connection

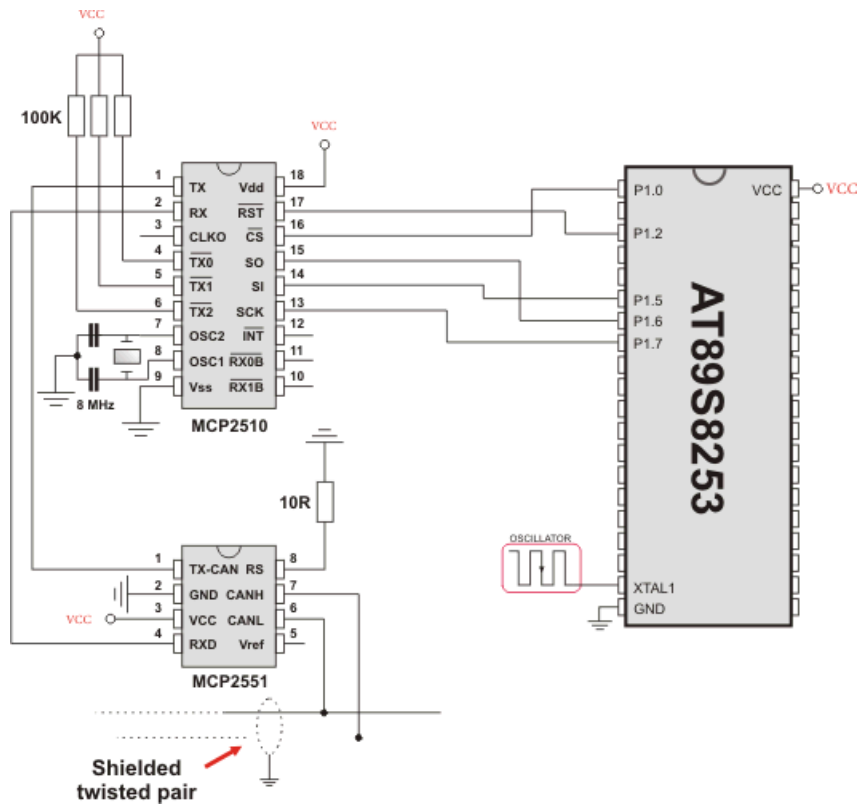

Example of interfacing CAN transceiver MCP2510 with MCU via SPI interface

EEPROM LIBRARY

EEPROM data memory is available with a number of 8051 family. The *mikroPascal for 8051* includes a library for comfortable work with MCU's internal EEPROM.

Note: EEPROM Library functions implementation is MCU dependent, consult the appropriate MCU datasheet for details about available EEPROM size and address range.

Library Routines

- Eeprom_Read
- Eeprom_Write
- Eeprom_Write_Block

Eeprom_Read

Prototype	<code>function Eeprom_Read(address: word): byte;</code>
Returns	Byte from the specified address.
Description	Reads data from specified <code>address</code> . Parameters : - <code>address</code> : address of the EEPROM memory location to be read.
Requires	Nothing.
Example	<pre>var eeAddr : word; temp : byte; ... eeAddr := 2 temp := Eeprom_Read(eeAddr);</pre>

Eeprom_Write

Prototype	<code>function Eeprom_Write(address: word; wrdata: byte): byte;</code>
Returns	<ul style="list-style-type: none"> - 0 writing was successful - 1 if error occurred
Description	<p>Writes <code>wrdata</code> to specified <code>address</code>.</p> <p>Parameters :</p> <ul style="list-style-type: none"> - <code>address</code>: address of the EEPROM memory location to be written. - <code>wrdata</code>: data to be written. <p>Note: Specified memory location will be erased before writing starts.</p>
Requires	Nothing.
Example	<pre>var eeWrite : byte = 0x55; wrAddr : word = 0x732; ... eeWrite := 0x55; wrAddr := 0x732; Eeprom_Write(wrAddr, eeWrite);</pre>

Eeprom_Write_Block

Prototype	<code>function Eeprom_Write_Block(address: word; var ptrdata: byte): byte;</code>
Returns	<ul style="list-style-type: none"> - 0 writing was successful - 1 if error occurred
Description	<p>Writes one EEPROM row (32 bytes block) of data.</p> <p>Parameters :</p> <ul style="list-style-type: none"> - <code>address</code>: starting address of the EEPROM memory block to be written. - <code>ptrdata</code>: data block to be written. <p>Note: Specified memory block will be erased before writing starts.</p>
Requires	<p>EEPROM module must support block write operations.</p> <p>It is the user's responsibility to maintain proper address alignment. In this case, address has to be a multiply of 32, which is the size (in bytes) of one row of MCU's EEPROM memory.</p>
Example	<pre>var wrAddr : word; iArr : string[16]; ... wrAddr : 0x0100; iArr := 'mikroElektronika'; Eeprom_Write_Block(wrAddr, iArr);</pre>

Library Example

This example demonstrates using the EEPROM Library with AT89S8253 MCU.

First, some data is written to EEPROM in byte and block mode; then the data is read from the same locations and displayed on P0, P1 and P2.

```
program Eeprom;
var dat : array [ 32] of byte;           // Data buffer, loop variable
    ii : byte;

begin
    for ii := 31 downto dat[ii] do nop;   // Fill data buffer

    Eeprom_Write(2,0xAA);                 // Write some data at address 2
    Eeprom_Write(0x732,0x55);            // Write some data at address 0x732
    Eeprom_Write_Block(0x100,dat);       // Write 32 bytes block at
address 0x100

    Delay_ms(1000);                       // Blink P0 and P1 diodes
    P0 := 0xFF;                            // to indicate reading start
    P1 := 0xFF;
    Delay_ms(1000);
    P0 := 0x00;
    P1 := 0x00;
    Delay_ms(1000);

    P0 := Eeprom_Read(2);                 // Read data from address
2 and display it on PORT0
    P1 := Eeprom_Read(0x732);            // Read data from address
0x732 and display it on PORT1
    Delay_ms(1000);

    for ii := 0 to 31 do // Read 32 bytes block from address 0x100
begin
    P2 := Eeprom_Read(0x100+ii);        // and display data
on PORT2
    Delay_ms(500);
end;
end.
```

GRAPHIC LCD LIBRARY

The *mikroPascal for 8051* provides a library for operating Graphic LCD 128x64 (with commonly used Samsung KS108/KS107 controller).

For creating a custom set of GLCD images use GLCD Bitmap Editor Tool.

External dependencies of Graphic LCD Library

The following variables must be defined in all projects using Graphic LCD Library:	Description:	Example :
<code>var GLCD_DataPort: byte; external; volatile; sfr;</code>	LCD Data Port.	<code>var GLCD_DataPort: byte at P0; sfr;</code>
<code>var GLCD_CS1: sbit; external;</code>	Chip Select 1 line.	<code>var GLCD_CS1: sbit at P2.B0;</code>
<code>var GLCD_CS2: sbit; external;</code>	Chip Select 2 line.	<code>var GLCD_CS2: sbit at P2.B0;</code>
<code>var GLCD_RS: sbit; external;</code>	Register select line.	<code>var GLCD_RS: sbit at P2.B0;</code>
<code>var GLCD_RW: sbit; external;</code>	Read/Write line.	<code>var GLCD_RW: sbit at P2.B0;</code>
<code>var GLCD_RST: sbit; external;</code>	Reset line.	<code>var GLCD_RST: sbit at P2.B0;</code>
<code>var GLCD_EN: sbit; external;</code>	Enable line.	<code>var GLCD_EN: sbit at P2.B0;</code>

Library Routines

Basic routines:

- Glcd_Init
- Glcd_Set_Side
- Glcd_Set_X
- Glcd_Set_Page
- Glcd_Read_Data
- Glcd_Write_Data

Advanced routines:

- Glcd_Fill
- Glcd_Dot
- Glcd_Line
- Glcd_V_Line
- Glcd_H_Line
- Glcd_Rectangle
- Glcd_Box
- Glcd_Circle
- Glcd_Set_Font
- Glcd_Write_Char
- Glcd_Write_Text
- Glcd_Image

Glcd_Init

Prototype	<code>procedure Glcd_Init();</code>
Returns	Nothing.
Description	Initializes the GLCD module. Each of the control lines is both port and pin configurable, while data lines must be on a single port (pins <0:7>).
Requires	<p>Global variables :</p> <ul style="list-style-type: none"> - GLCD_CS1 : chip select 1 signal pin - GLCD_CS2 : chip select 2 signal pin - GLCD_RS : register select signal pin - GLCD_RW : read/write signal pin - GLCD_EN : enable signal pin - GLCD_RST : reset signal pin - GLCD_DataPort : data port <p>must be defined before using this function.</p>
Example	<pre>' glcd pinout settings var GLCD_DataPort: byte at P0; sfr; var GLCD_CS1 : sbit at P2.B0; GLCD_CS2 : sbit at P2.B1; GLCD_RS : sbit at P2.B2; GLCD_RW : sbit at P2.B3; GLCD_RST : sbit at P2.B5; GLCD_EN : sbit at P2.B4; ... Glcd_Init();</pre>

Glcd_Set_Side

Prototype	<code>procedure Glcd_Set_Side(x_pos: byte);</code>
Returns	Nothing.
Description	<p>Selects GLCD side. Refer to the GLCD datasheet for detailed explanation.</p> <p>Parameters :</p> <p>- <code>x_pos</code>: position on x-axis. Valid values: 0..127</p> <p>The parameter <code>x_pos</code> specifies the GLCD side: values from 0 to 63 specify the left side, values from 64 to 127 specify the right side.</p> <p>Note: For side, x axis and page layout explanation see schematic at the bottom of this page.</p>
Requires	GLCD needs to be initialized, see <code>Glcd_Init</code> routine.
Example	<p>The following two lines are equivalent, and both of them select the left side of GLCD:</p> <pre>Glcd_Select_Side(0); Glcd_Select_Side(10);</pre>

Glcd_Set_X

Prototype	<code>procedure Glcd_Set_X(x_pos: byte);</code>
Returns	Nothing.
Description	<p>Sets x-axis position to <code>x_pos</code> dots from the left border of GLCD within the selected side.</p> <p>Parameters :</p> <p>- <code>x_pos</code>: position on x-axis. Valid values: 0..63</p> <p>Note: For side, x axis and page layout explanation see schematic at the bottom of this page.</p>
Requires	GLCD needs to be initialized, see <code>Glcd_Init</code> routine.
Example	<pre>Glcd_Set_X(25);</pre>

Glcd_Set_Page

Prototype	<code>procedure Glcd_Set_Page(page: byte);</code>
Returns	Nothing.
Description	<p>Selects page of the GLCD.</p> <p>Parameters :</p> <p>- <code>page</code>: page number. Valid values: 0..7</p> <p>Note: For side, x axis and page layout explanation see schematic at the bottom of this page.</p>
Requires	GLCD needs to be initialized, see <code>Glcd_Init</code> routine.
Example	<code>Glcd_Set_Page(5);</code>

Glcd_Read_Data

Prototype	<code>function Glcd_Read_Data(): byte;</code>
Returns	One byte from GLCD memory.
Description	Reads data from from the current location of GLCD memory and moves to the next location.
Requires	<p>GLCD needs to be initialized, see <code>Glcd_Init</code> routine.</p> <p>GLCD side, x-axis position and page should be set first. See functions <code>Glcd_Set_Side</code>, <code>Glcd_Set_X</code>, and <code>Glcd_Set_Page</code>.</p>
Example	<pre>var data: byte; ... data := Glcd_Read_Data();</pre>

Glcd_Write_Data

Prototype	<code>procedure Glcd_Write_Data(ddata: byte);</code>
Returns	Nothing.
Description	Writes one byte to the current location in GLCD memory and moves to the next location. Parameters : - <code>ddata</code> : data to be written
Requires	GLCD needs to be initialized, see <code>Glcd_Init</code> routine. GLCD side, x-axis position and page should be set first. See functions <code>Glcd_Set_Side</code> , <code>Glcd_Set_X</code> , and <code>Glcd_Set_Page</code> .
Example	<pre>var data: byte; ... Glcd_Write_Data(data);</pre>

Glcd_Fill

Prototype	<code>procedure Glcd_Fill(pattern: byte);</code>
Returns	Nothing.
Description	Fills GLCD memory with the byte <code>pattern</code> . Parameters : - <code>pattern</code> : byte to fill GLCD memory with To clear the GLCD screen, use <code>Glcd_Fill(0)</code> . To fill the screen completely, use <code>Glcd_Fill(0xFF)</code> .
Requires	GLCD needs to be initialized, see <code>Glcd_Init</code> routine.
Example	<pre>' Clear screen Glcd_Fill(0);</pre>

Glcd_Dot

Prototype	<code>procedure Glcd_Dot(x_pos: byte; y_pos: byte; color: byte);</code>
Returns	Nothing.
Description	<p>Draws a dot on GLCD at coordinates (<code>x_pos</code>, <code>y_pos</code>).</p> <p>Parameters :</p> <ul style="list-style-type: none"> - <code>x_pos</code>: x position. Valid values: 0..127 - <code>y_pos</code>: y position. Valid values: 0..63 - <code>color</code>: color parameter. Valid values: 0..2 <p>The parameter <code>color</code> determines a dot state: 0 clears dot, 1 puts a dot, and 2 inverts dot state.</p> <p>Note: For x and y axis layout explanation see schematic at the bottom of this page.</p>
Requires	GLCD needs to be initialized, see <code>Glcd_Init</code> routine.
Example	<code>' Invert the dot in the upper left corner Glcd_Dot(0, 0, 2);</code>

Glcd_Line

Prototype	<code>procedure Glcd_Line(x_start: integer; y_start: integer; x_end integer; y_end integer; color: byte);</code>
Returns	Nothing.
Description	<p>Draws a line on GLCD.</p> <p>Parameters :</p> <ul style="list-style-type: none"> - <code>x_start</code>: x coordinate of the line start. Valid values: 0..127 - <code>y_start</code>: y coordinate of the line start. Valid values: 0..63 - <code>x_end</code>: x coordinate of the line end. Valid values: 0..127 - <code>y_end</code>: y coordinate of the line end. Valid values: 0..63 - <code>color</code>: color parameter. Valid values: 0..2 <p>The parameter <code>color</code> determines the line color: 0 white, 1 black, and 2 inverts each dot.</p>
Requires	GLCD needs to be initialized, see <code>Glcd_Init</code> routine.
Example	<code>' Draw a line between dots (0,0) and (20,30) Glcd_Line(0, 0, 20, 30, 1);</code>

Glcd_V_Line

Prototype	<code>procedure Glcd_V_Line(y_start: byte; y_end: byte; x_pos: byte; color: byte);</code>
Returns	Nothing.
Description	<p>Draws a vertical line on GLCD.</p> <p>Parameters :</p> <ul style="list-style-type: none">- <code>y_start</code>: y coordinate of the line start. Valid values: 0..63- <code>y_end</code>: y coordinate of the line end. Valid values: 0..63- <code>x_pos</code>: x coordinate of vertical line. Valid values: 0..127- <code>color</code>: color parameter. Valid values: 0..2 <p>The parameter <code>color</code> determines the line color: 0 white, 1 black, and 2 inverts each dot.</p>
Requires	GLCD needs to be initialized, see <code>Glcd_Init</code> routine.
Example	<pre>' Draw a vertical line between dots (10,5) and (10,25) Glcd_V_Line(5, 25, 10, 1);</pre>

Glcd_H_Line

Prototype	<code>procedure Glcd_V_Line(x_start: byte; x_end: byte; y_pos: byte; color: byte);</code>
Returns	Nothing.
Description	<p>Draws a horizontal line on GLCD.</p> <p>Parameters :</p> <ul style="list-style-type: none">- <code>x_start</code>: x coordinate of the line start. Valid values: 0..127- <code>x_end</code>: x coordinate of the line end. Valid values: 0..127- <code>y_pos</code>: y coordinate of horizontal line. Valid values: 0..63- <code>color</code>: color parameter. Valid values: 0..2 <p>The parameter <code>color</code> determines the line color: 0 white, 1 black, and 2 inverts each dot.</p>
Requires	GLCD needs to be initialized, see <code>Glcd_Init</code> routine.
Example	<pre>' Draw a horizontal line between dots (10,20) and (50,20) Glcd_H_Line(10, 50, 20, 1);</pre>

Glcd_Rectangle

Prototype	<code>procedure Glcd_Rectangle(x_upper_left: byte; y_upper_left: byte; x_bottom_right: byte; y_bottom_right: byte; color: byte);</code>
Returns	Nothing.
Description	<p>Draws a rectangle on GLCD.</p> <p>Parameters :</p> <ul style="list-style-type: none"> - <code>x_upper_left</code>: x coordinate of the upper left rectangle corner. Valid values: 0..127 - <code>y_upper_left</code>: y coordinate of the upper left rectangle corner. Valid values: 0..63 - <code>x_bottom_right</code>: x coordinate of the lower right rectangle corner. Valid values: 0..127 - <code>y_bottom_right</code>: y coordinate of the lower right rectangle corner. Valid values: 0..63 - <code>color</code>: color parameter. Valid values: 0..2 <p>The parameter <code>color</code> determines the color of the rectangle border: 0 white, 1 black, and 2 inverts each dot.</p>
Requires	GLCD needs to be initialized, see <code>Glcd_Init</code> routine.
Example	<pre>' Draw a rectangle between dots (5,5) and (40,40) Glcd_Rectangle(5, 5, 40, 40, 1);</pre>

Glcd_Box

Prototype	<code>procedure Glcd_Box(x_upper_left: byte; y_upper_left: byte; x_bottom_right: byte; y_bottom_right: byte; color: byte);</code>
Returns	Nothing.
Description	<p>Draws a box on GLCD.</p> <p>Parameters :</p> <ul style="list-style-type: none"> - <code>x_upper_left</code>: x coordinate of the upper left box corner. Valid values: 0..127 - <code>y_upper_left</code>: y coordinate of the upper left box corner. Valid values: 0..63 - <code>x_bottom_right</code>: x coordinate of the lower right box corner. Valid values: 0..127 - <code>y_bottom_right</code>: y coordinate of the lower right box corner. Valid values: 0..63 - <code>color</code>: color parameter. Valid values: 0..2 <p>The parameter <code>color</code> determines the color of the box fill: 0 white, 1 black, and 2 inverts each dot.</p>
Requires	GLCD needs to be initialized, see <code>Glcd_Init</code> routine.
Example	<pre>' Draw a box between dots (5,15) and (20,40) Glcd_Box(5, 15, 20, 40, 1);</pre>

Glcd_Circle

Prototype	<code>procedure Glcd_Circle(x_center: integer; y_center: integer; radius: integer; color: byte);</code>
Returns	Nothing.
Description	<p>Draws a circle on GLCD.</p> <p>Parameters :</p> <ul style="list-style-type: none"> - <code>x_center</code>: x coordinate of the circle center. Valid values: 0..127 - <code>y_center</code>: y coordinate of the circle center. Valid values: 0..63 - <code>radius</code>: radius size - <code>color</code>: color parameter. Valid values: 0..2 <p>The parameter <code>color</code> determines the color of the circle line: 0 white, 1 black, and 2 inverts each dot.</p>
Requires	GLCD needs to be initialized, see <code>Glcd_Init</code> routine.
Example	<code>' Draw a circle with center in (50,50) and radius=10 Glcd_Circle(50, 50, 10, 1);</code>

Glcd_Set_Font

Prototype	<code>procedure Glcd_Set_Font(const ActiveFont: ^byte; FontWidth: byte; FontHeight: byte; FontOffs: word);</code>
Returns	Nothing.
Description	<p>Sets font that will be used with <code>Glcd_Write_Char</code> and <code>Glcd_Write_Text</code> routines.</p> <p>Parameters :</p> <ul style="list-style-type: none"> - <code>activeFont</code>: font to be set. Needs to be formatted as an array of byte - <code>aFontWidth</code>: width of the font characters in dots. - <code>aFontHeight</code>: height of the font characters in dots. - <code>aFontOffs</code>: number that represents difference between the mikroPascal for 8051 character set and regular ASCII set (eg. if 'A' is 65 in ASCII character, and 'A' is 45 in the <i>mikroPascal for 8051</i> character set, <code>aFontOffs</code> is 20). Demo fonts supplied with the library have an offset of 32, which means that they start with space. <p>The user can use fonts given in the file “<code>__Lib_GLCDFonts.mpas</code>” file located in the Uses folder or create his own fonts.</p>
Requires	GLCD needs to be initialized, see <code>Glcd_Init</code> routine.
Example	<code>' Use the custom 5x7 font "myfont" which starts with space (32): Glcd_Set_Font(myfont, 5, 7, 32);</code>

Glcd_Write_Char

Prototype	<code>procedure Glcd_Write_Char(chr: byte; x_pos: byte; page_num: byte; color: byte);</code>
Returns	Nothing.
Description	<p>Prints character on the GLCD.</p> <p>Parameters :</p> <ul style="list-style-type: none"> - <code>chr</code>: character to be written - <code>x_pos</code>: character starting position on x-axis. Valid values: 0..(127-FontWidth) - <code>page_num</code>: the number of the page on which character will be written. Valid values: 0..7 - <code>color</code>: color parameter. Valid values: 0..2 <p>The parameter <code>color</code> determines the color of the character: 0 white, 1 black, and 2 inverts each dot.</p> <p>Note: For x axis and page layout explanation see schematic at the bottom of this page.</p>
Requires	GLCD needs to be initialized, see <code>Glcd_Init</code> routine. Use <code>Glcd_Set_Font</code> to specify the font for display; if no font is specified, then default 5x8 font supplied with the library will be used.
Example	<code>' Write character 'C' on the position 10 inside the page 2: Glcd_Write_Char('C', 10, 2, 1);</code>

Glcd_Write_Text

Prototype	<code>procedure Glcd_Write_Text(var text: string[19]; x_pos: byte; page_num: byte; color: byte);</code>
Returns	Nothing.
Description	<p>Prints text on GLCD.</p> <p>Parameters :</p> <ul style="list-style-type: none"> - <code>text</code>: text to be written - <code>x_pos</code>: text starting position on x-axis. - <code>page_num</code>: the number of the page on which text will be written. Valid values: 0..7 - <code>color</code>: color parameter. Valid values: 0..2 <p>The parameter <code>color</code> determines the color of the text: 0 white, 1 black, and 2 inverts each dot.</p> <p>Note: For x axis and page layout explanation see schematic at the bottom of this page.</p>
Requires	GLCD needs to be initialized, see <code>Glcd_Init</code> routine. Use <code>Glcd_Set_Font</code> to specify the font for display; if no font is specified, then default 5x8 font supplied with the library will be used.
Example	<code>' Write text "Hello world!" on the position 10 inside the page 2: Glcd_Write_Text("Hello world!", 10, 2, 1);</code>

Glcd_Image

Prototype	<code>procedure Glcd_Image(const image: ^byte);</code>
Returns	Nothing.
Description	<p>Displays bitmap on GLCD.</p> <p>Parameters :</p> <ul style="list-style-type: none"> - <code>image</code>: image to be displayed. Bitmap array must be located in code memory. <p>Use the <i>mikroPascal for 8051</i> integrated GLCD Bitmap Editor to convert image to a constant array suitable for displaying on GLCD.</p>
Requires	GLCD needs to be initialized, see <code>Glcd_Init</code> routine.
Example	<code>' Draw image my_image on GLCD Glcd_Image(my_image);</code>

Library Example

The following example demonstrates routines of the GLCD library: initialization, clear(pattern fill), image displaying, drawing lines, circles, boxes and rectangles, text displaying and handling.

```

program GLCD_Test;

//Declarations-----
-----
uses bitmap;
//-----end-
declarations

// Glcd module connections
var GLCD_CS1 : sbit at P2.B0;           // GLCD chip select 1 signal
var GLCD_CS2 : sbit at P2.B1;           // GLCD chip select 2 signal
var GLCD_RS  : sbit at P2.B2;           // GLCD register select signal
var GLCD_RW  : sbit at P2.B3;           // GLCD read/write signal
var GLCD_RST : sbit at P2.B5;           // GLCD reset signal
var GLCD_EN  : sbit at P2.B4;           // GLCD enable signal
// End Glcd module connections

procedure delay2S();                    // 2 seconds delay function
begin
    Delay_ms(2000);
end;

var ii : word;
    someText : array[ 17] of byte;
begin

    Glcd_Init();                          // Initialize GLCD
    Glcd_Fill(0x00);                       // Clear GLCD

    while (TRUE) do
        begin
            Glcd_Image(@advanced8051_bmp); // Draw image
            Delay2S(); Delay2S();

            Glcd_Fill(0x00);

            Glcd_Box(62,40,124,56,1);       // Draw box
            Glcd_Rectangle(5,5,84,35,1);    // Draw rectangle
            Glcd_Line(0, 63, 127, 0,1);     // Draw line

            delay2S();

```

```
    for ii := 5 to 59 do // Draw horizontal and vertical lines
    begin
        Delay_ms(250);
        Glcd_V_Line(2, 54, ii, 1);
        Glcd_H_Line(2, 120, ii, 1);
    end;

    Delay2S();

    Glcd_Fill(0x00);

    Glcd_Set_Font(@Character8x8, 8, 8, 32); // Choose font, see
    __Lib_GLCDFonts.c in Uses folder
    Glcd_Write_Text('mikroE', 5, 7, 2); // Write string

    for ii := 1 to 10 do // Draw circles
        Glcd_Circle(63,32, 3*ii, 1);
    Delay2S();

    Glcd_Box(12,20, 70,57, 2); // Draw box
    Delay2S();

    Glcd_Set_Font(@FontSystem5x8, 5, 8, 32); // Change font
    someText := 'BIG:ONE';
    Glcd_Write_Text(someText, 5,3, 2); // Write string
    Delay2S();

    someText := 'SMALL:NOT:SMALLER';
    Glcd_Write_Text(someText, 20,5, 1); // Write string
    Delay2S();

end;

end.
```

HW Connection

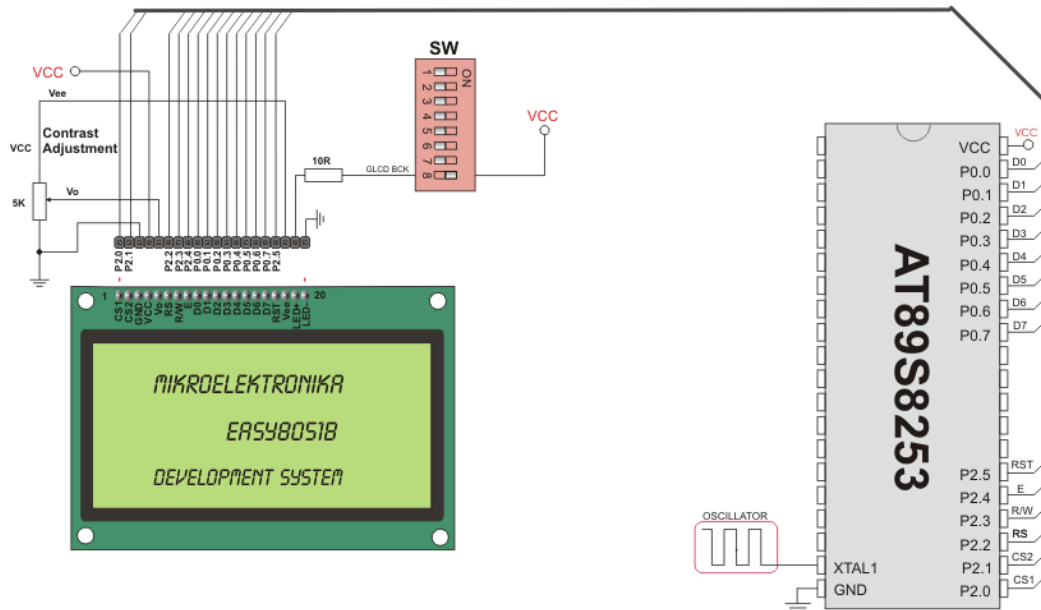
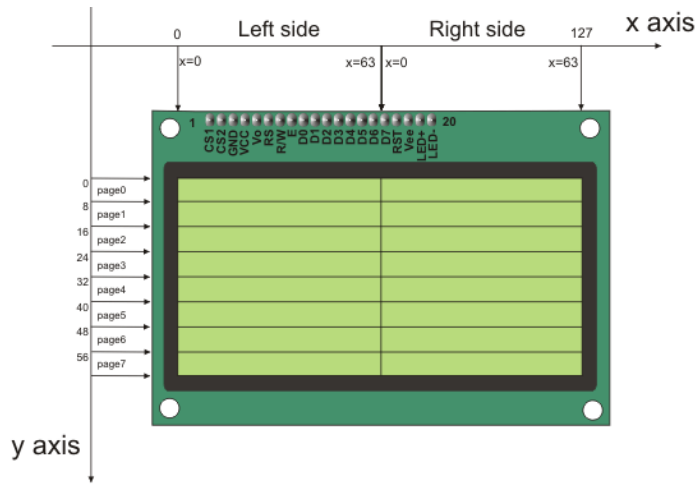

GLCD HW connection

KEYPAD LIBRARY

The *mikroPascal for 8051* provides a library for working with 4x4 keypad. The library routines can also be used with 4x1, 4x2, or 4x3 keypad. For connections explanation see schematic at the bottom of this page.

Note: Since sampling lines for 8051 MCUs are activated by logical zero Keypad Library can not be used with hardwares that have protective diodes connected with anode to MCU side, such as mikroElektronika's Keypad extra board HW.Rev v1.20

External dependencies of Keypad Library

The following variable must be defined in all projects using Keypad Library:	Description:	Example :
<pre>var keypadPort: byte; external; sfr;</pre>	Keypad Port.	<pre>var keypadPort: byte at P0; sfr;</pre>

Library Routines

- Keypad_Init
- Keypad_Key_Press
- Keypad_Key_Click

Keypad_Init

Prototype	<code>procedure Keypad_Init();</code>
Returns	Nothing.
Description	Initializes port for working with keypad.
Requires	<code>keypadPort</code> variable must be defined before using this function.
Example	<pre>// Initialize P0 for communication with keypad var keypadPort : byte at P0; sfr; ... Keypad_Init();</pre>

Keypad_Key_Press

Prototype	<code>function Keypad_Key_Press(): byte;</code>
Returns	The code of a pressed key (1..16). If no key is pressed, returns 0.
Description	Reads the key from keypad when key gets pressed.
Requires	Port needs to be initialized for working with the Keypad library, see <code>Keypad_Init</code> .
Example	<pre>var kp : byte; ... kp := Keypad_Key_Press();</pre>

Keypad_Key_Click

Prototype	<code>function Keypad_Key_Click(): byte;</code>
Returns	The code of a clicked key (1..16). If no key is clicked, returns 0.
Description	Call to <code>Keypad_Key_Click</code> is a blocking call: the function waits until some key is pressed and released. When released, the function returns 1 to 16, depending on the key. If more than one key is pressed simultaneously the function will wait until all pressed keys are released. After that the function will return the code of the first pressed key.
Requires	Port needs to be initialized for working with the Keypad library, see <code>Keypad_Init</code> .
Example	<pre>var kp : byte; ... kp := Keypad_Key_Click();</pre>

Library Example

This is a simple example of using the Keypad Library. It supports keypads with 1..4 rows and 1..4 columns. The code being returned by Keypad_Key_Click() function is in range from 1..16. In this example, the code returned is transformed into ASCII codes [0..9,A..F] and displayed on LCD. In addition, a small single-byte counter displays in the second LCD row number of key presses.

```
program Keypad_Test;
var kp, cnt, oldstate : byte;
    txt : array[5] of byte;

// Keypad module connections
var keypadPort : byte at P0; sfr
// End Keypad module connections

// lcd pinout definition
var LCD_RS : sbit at P2.B0;
var LCD_EN : sbit at P2.B1;

var LCD_D7 : sbit at P2.B5;
var LCD_D6 : sbit at P2.B4;
var LCD_D5 : sbit at P2.B3;
var LCD_D4 : sbit at P2.B2;
// end lcd definitions

begin
    oldstate := 0;
    cnt := 0;
    Keypad_Init();
    Lcd_Init();
    Lcd_Cmd(LCD_CLEAR);
    Lcd_Cmd(LCD_CURSOR_OFF);

    Lcd_Out(1, 1, 'Key  :');
    Lcd_Out(2, 1, 'Times:');

    while TRUE do
        begin
            kp := 0;

            // Wait for key to be pressed and released
            while ( kp = 0 )do
                kp := Keypad_Key_Click();// Store key code in kp variable
                // Reset counter
                // Initialize Keypad
                // Initialize LCD
                // Clear display
                // Cursor off
                // Write message text on LCD
        end
    end
```

```

// Prepare value for output, transform key to it's ASCII value
  case kp of
    //case 10: kp = 42;    // '*'           // Uncomment this
block for keypad4x3
    //case 11: kp = 48;    // '0'
    //case 12: kp = 35;    // '#'
    //default: kp += 48;

    1: kp := 49; // 1// Uncomment this block for keypad4x4
    2: kp := 50; // 2
    3: kp := 51; // 3
    4: kp := 65; // A
    5: kp := 52; // 4
    6: kp := 53; // 5
    7: kp := 54; // 6
    8: kp := 66; // B
    9: kp := 55; // 7
   10: kp := 56; // 8
   11: kp := 57; // 9
   12: kp := 67; // C
   13: kp := 42; // *
   14: kp := 48; // 0
   15: kp := 35; // #
   16: kp := 68; // D

  end; //case

if (kp <> oldstate) then // Pressed key differs from previous
  begin
    cnt := 1;
    oldstate := kp;
  end
else // Pressed key is same as previous
  Inc(cnt);

  Lcd_Chr(1, 10, kp); // Print key ASCII value on LCD

  if (cnt = 255) then // If counter variable overflow
  begin
    cnt := 0;
    Lcd_Out(2, 10, ' ');
  end;

  WordToStr(cnt, txt); // Transform counter value to string
  Lcd_Out(2, 10, txt); // Display counter value on LCD

end;

end.

```

HW Connection

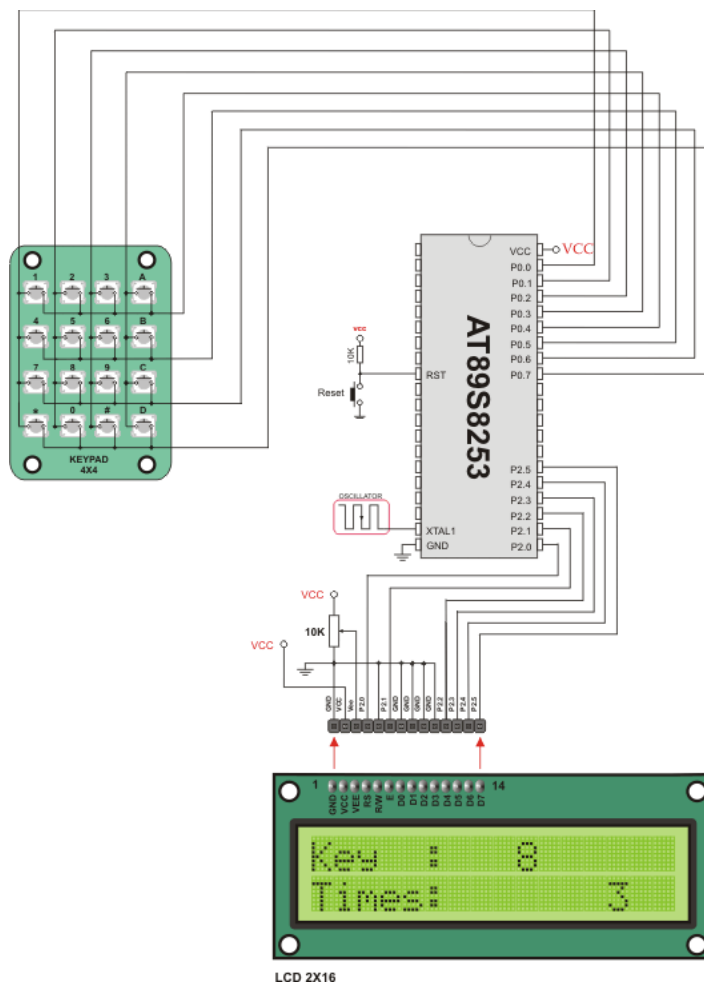

4x4 Keypad connection scheme

LCD LIBRARY

The *mikroPascal for 8051* provides a library for communication with LCDs (with HD44780 compliant controllers) through the 4-bit interface. An example of LCD connections is given on the schematic at the bottom of this page.

For creating a set of custom LCD characters use LCD Custom Character Tool.

External dependencies of LCD Library

The following variables must be defined in all projects using LCD Library:	Description:	Example :
<code>var LCD_RS: sbit; external;</code>	Register Select line.	<code>var LCD_RS: sbit at P2.B0;</code>
<code>var LCD_EN: sbit; external;</code>	Enable line.	<code>var LCD_EN: sbit at P2.B1;</code>
<code>var LCD_D7: sbit; external;</code>	Data 7 line.	<code>var LCD_D7: sbit at P2.B5;</code>
<code>var LCD_D6: sbit; external;</code>	Data 6 line.	<code>var LCD_D6: sbit at P2.B4;</code>
<code>var LCD_D5: sbit; external;</code>	Data 5 line.	<code>var LCD_D5: sbit at P2.B3;</code>
<code>var LCD_D4: sbit; external;</code>	Data 4 line.	<code>var LCD_D4: sbit at P2.B2;</code>

Library Routines

- Lcd_Init
- Lcd_Out
- Lcd_Out_Cp
- Lcd_Chr
- Lcd_Chr_Cp
- Lcd_Cmd

Lcd_Init

Prototype	<code>procedure Lcd_Init();</code>
Returns	Nothing.
Description	Initializes LCD module.
Requires	<p>Global variables:</p> <ul style="list-style-type: none"> - LCD_D7 : data bit 7 - LCD_D6 : data bit 6 - LCD_D5 : data bit 5 - LCD_D4 : data bit 4 - RS: register select (data/instruction) signal pin - EN: enable signal pin <p>must be defined before using this function.</p>
Example	<pre>// lcd pinout settings var LCD_RS : sbit at P2.B0; LCD_EN : sbit at P2.B1; LCD_D7 : sbit at P2.B5; LCD_D6 : sbit at P2.B4; LCD_D5 : sbit at P2.B3; LCD_D4 : sbit at P2.B2; ... Lcd_Init();</pre>

Lcd_Out

Prototype	<code>procedure Lcd_Out(row: byte; column: byte; var text: string[19]);</code>
Returns	Nothing.
Description	<p>Prints text on LCD starting from specified position. Both string variables and literals can be passed as a text.</p> <p>Parameters :</p> <ul style="list-style-type: none"> - <code>row</code>: starting position row number - <code>column</code>: starting position column number - <code>text</code>: text to be written
Requires	The LCD module needs to be initialized. See Lcd_Init routine.
Example	<pre>// Write text "Hello!" on LCD starting from row 1, column 3: Lcd_Out(1, 3, "Hello!");</pre>

Lcd_Out_Cp

Prototype	<code>procedure Lcd_Out_Cp(var text: string[19]);</code>
Returns	Nothing.
Description	<p>Prints text on LCD at current cursor position. Both string variables and literals can be passed as a text.</p> <p>Parameters :</p> <ul style="list-style-type: none"> - <code>text</code>: text to be written
Requires	The LCD module needs to be initialized. See Lcd_Init routine.
Example	<pre>// Write text "Here!" at current cursor position: Lcd_Out_Cp("Here!");</pre>

Lcd_Chr

Prototype	<code>procedure Lcd_Chr(row: byte; column: byte; out_char: byte);</code>
Returns	Nothing.
Description	<p>Prints character on LCD at specified position. Both variables and literals can be passed as a character.</p> <p>Parameters :</p> <ul style="list-style-type: none">- <code>row</code>: writing position row number- <code>column</code>: writing position column number- <code>out_char</code>: character to be written
Requires	The LCD module needs to be initialized. See <code>Lcd_Init</code> routine.
Example	<pre>// Write character "i" at row 2, column 3: Lcd_Chr(2, 3, 'i');</pre>

Lcd_Chr_Cp

Prototype	<code>procedure Lcd_Chr_Cp(out_char: byte);</code>
Returns	Nothing.
Description	<p>Prints character on LCD at current cursor position. Both variables and literals can be passed as a character.</p> <p>Parameters :</p> <ul style="list-style-type: none">- <code>out_char</code>: character to be written
Requires	The LCD module needs to be initialized. See <code>Lcd_Init</code> routine.
Example	<pre>// Write character "e" at current cursor position: Lcd_Chr_Cp('e');</pre>

Lcd_Cmd

Prototype	<code>procedure Lcd_Cmd(out_char: byte);</code>
Returns	Nothing.
Description	<p>Sends command to LCD.</p> <p>Parameters :</p> <p>- <code>out_char</code>: command to be sent</p> <p>Note: Predefined constants can be passed to the function, see Available LCD Commands.</p>
Requires	The LCD module needs to be initialized. See Lcd_Init table.
Example	<code>// Clear LCD display: Lcd_Cmd(LCD_CLEAR);</code>

Available LCD Commands

Lcd Command	Purpose
<code>LCD_FIRST_ROW</code>	Move cursor to the 1st row
<code>LCD_SECOND_ROW</code>	Move cursor to the 2nd row
<code>LCD_THIRD_ROW</code>	Move cursor to the 3rd row
<code>LCD_FOURTH_ROW</code>	Move cursor to the 4th row
<code>LCD_CLEAR</code>	Clear display
<code>LCD_RETURN_HOME</code>	Return cursor to home position, returns a shifted display to its original position. Display data RAM is unaffected.
<code>LCD_CURSOR_OFF</code>	Turn off cursor
<code>LCD_UNDERLINE_ON</code>	Underline cursor on
<code>LCD_BLINK_CURSOR_ON</code>	Blink cursor on
<code>LCD_MOVE_CURSOR_LEFT</code>	Move cursor left without changing display data RAM
<code>LCD_MOVE_CURSOR_RIGHT</code>	Move cursor right without changing display data RAM
<code>LCD_TURN_ON</code>	Turn LCD display on
<code>LCD_TURN_OFF</code>	Turn LCD display off
<code>LCD_SHIFT_LEFT</code>	Shift display left without changing display data RAM
<code>LCD_SHIFT_RIGHT</code>	Shift display right without changing display data RAM

Library Example

The following code demonstrates usage of the LCD Library routines:

```
program Lcd_Test;

// LCD module connections
var LCD_RS : sbit at P2.B0;
var LCD_EN : sbit at P2.B1;

var LCD_D7 : sbit at P2.B5;
var LCD_D6 : sbit at P2.B4;
var LCD_D5 : sbit at P2.B3;
var LCD_D4 : sbit at P2.B2;
// End LCD module connections

var txt1 : array[16] of byte;
    txt2 : array[ 9] of byte;
    txt3 : array[ 7] of byte;
    txt4 : array[ 7] of byte;
    i : byte;          // Loop variable

procedure Move_Delay();           // Function used for text
moving                             // moving
begin
    Delay_ms(500);                // You can change the mov-
ing speed here
end;

begin
    txt1 := 'mikroElektronika';
    txt2 := 'Easy8051B';
    txt3 := 'lcd4bit';
    txt4 := 'example';
    Lcd_Init();                    // Initialize LCD
    Lcd_Cmd(LCD_CLEAR);           // Clear display
    Lcd_Cmd(LCD_CURSOR_OFF);     // Cursor off

    LCD_Out(1,6,txt3);            // Write text in first row
    LCD_Out(2,6,txt4);            // Write text in second row
    Delay_ms(2000);
    Lcd_Cmd(LCD_CLEAR);          // Clear display

    LCD_Out(1,1,txt1);            // Write text in first row
    LCD_Out(2,4,txt2);            // Write text in second row
    Delay_ms(500);
```

```
// Moving text
  for i:=0 to 3 do          // Move text to the right 4 times
  begin
    Lcd_Cmd(LCD_SHIFT_RIGHT);
    Move_Delay();
  end;

  while TRUE do          // Endless loop
  begin
    for i:=0 to 6 do      // Move text to the left 7 times
    begin
      Lcd_Cmd(LCD_SHIFT_LEFT);
      Move_Delay();
    end;

    for i:=0 to 6 do      // Move text to the right 7 times
    begin
      Lcd_Cmd(LCD_SHIFT_RIGHT);
      Move_Delay();
    end;

  end;
end.
```

HW connection

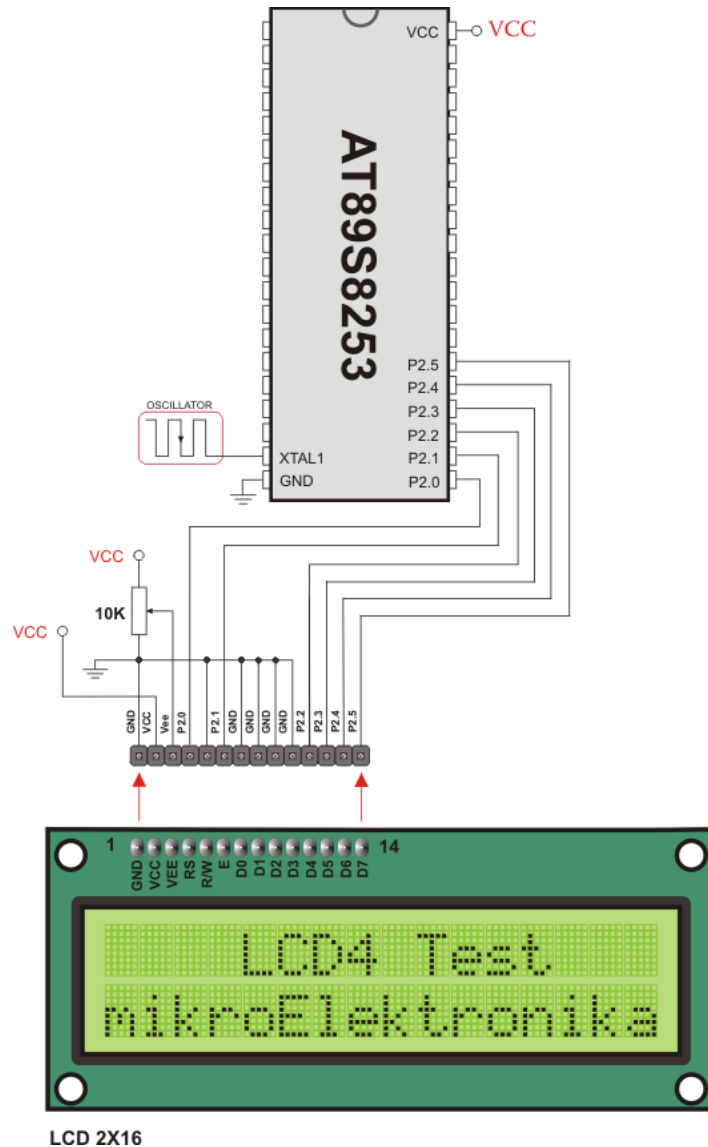

LCD HW connection

ONEWIRE LIBRARY

The OneWire library provides routines for communication via the Dallas OneWire protocol, e.g. with DS18x20 digital thermometer. OneWire is a Master/Slave protocol, and all communication cabling required is a single wire. OneWire enabled devices should have open collector drivers (with single pull-up resistor) on the shared data line.

Slave devices on the OneWire bus can even get their power supply from data line. For detailed schematic see device datasheet.

Some basic characteristics of this protocol are:

- single master system,
- low cost,
- low transfer rates (up to 16 kbps),
- fairly long distances (up to 300 meters),
- small data transfer packages.

Each OneWire device has also a unique 64-bit registration number (8-bit device type, 48-bit serial number and 8-bit CRC), so multiple slaves can co-exist on the same bus.

Note: Oscillator frequency F_{osc} needs to be at least 8MHz in order to use the routines with Dallas digital thermometers.

External dependencies of OneWire Library

This variable must be defined in any project that is using OneWire Library:	Description:	Example :
<code>var OW_Bit: sbit; external;</code>	OneWire line.	<code>var OW_Bit: sbit; at P2.B7;</code>

Library Routines

- Ow_Reset
- Ow_Read
- Ow_Write

Ow_Reset

Prototype	<code>function Ow_Reset(): word;</code>
Returns	- 0 if the device is present - 1 if the device is not present
Description	Issues OneWire reset signal for DS18x20. Parameters : - None.
Requires	Devices compliant with the Dallas OneWire protocol. Global variable <code>OW_Bit</code> must be defined before using this function.
Example	<pre>// Issue Reset signal on One-Wire Bus Ow_Reset();</pre>

Ow_Read

Prototype	<code>function Ow_Read(): byte;</code>
Returns	Data read from an external device over the OneWire bus.
Description	Reads one byte of data via the OneWire bus.
Requires	Devices compliant with the Dallas OneWire protocol. Global variable <code>OW_Bit</code> must be defined before using this function.
Example	<pre>// Read a byte from the One-Wire Bus var read_data : byte; ... read_data := Ow_Read();</pre>

Ow_Write

Prototype	<code>procedure Ow_Write(par: byte);</code>
Returns	Nothing.
Description	Writes one byte of data via the OneWire bus. Parameters : - <code>par</code> : data to be written
Requires	Devices compliant with the Dallas OneWire protocol. Global variable <code>OW_Bit</code> must be defined before using this function.
Example	<code>// Send a byte to the One-Wire Bus Ow_Write(0xCC);</code>

Library Example

This example reads the temperature using DS18x20 connected to pin P1.2. After reset, MCU obtains temperature from the sensor and prints it on the LCD. Make sure to pull-up P1.2 line and to turn off the P1 leds.

```
program OneWire;

// lcd pinout definition
var LCD_RS : sbit at P2.B0;
var LCD_EN : sbit at P2.B1;

var LCD_D7 : sbit at P2.B5;
var LCD_D6 : sbit at P2.B4;
var LCD_D5 : sbit at P2.B3;
var LCD_D4 : sbit at P2.B2;
// end lcd definition

// OneWire pinout
var OW_Bit : sbit at P1.B2;
// end OneWire definition

// Set TEMP_RESOLUTION to the corresponding resolution of used DS18x20 sensor:
// 18S20: 9 (default setting; can be 9,10,11,or 12)
// 18B20: 12
const TEMP_RESOLUTION : byte = 9;

var text : array[8] of byte;
    temp : word;
```

```

procedure Display_Temperature( temp2write : word ) ;
const RES_SHIFT : byte = TEMP_RESOLUTION - 8;
var temp_whole : byte;
    temp_fraction : word;

begin
    text := '000.0000';
    // check if temperature is negative
    if (temp2write and 0x8000) then
        begin
            text[0] := '-';
            temp2write := not temp2write + 1;
        end;

    // extract temp_whole
    temp_whole := temp2write shr RES_SHIFT ;

    // convert temp_whole to characters
    if ( temp_whole/100 ) then
        text[0] := temp_whole/100 + 48;

    text[1] := (temp_whole/10) mod 10 + 48;           // Extract
tens digit
    text[2] := temp_whole mod 10 + 48;           // Extract
ones digit

    // extract temp_fraction and convert it to unsigned int
    temp_fraction := temp2write shl (4-RES_SHIFT);
    temp_fraction := temp_fraction and 0x000F;
    temp_fraction := temp_fraction * 625;

    // convert temp_fraction to characters
    text[4] := temp_fraction/1000 + 48;           // Extract
thousands digit
    text[5] := (temp_fraction/100) mod 10 + 48;   // Extract
hundreds digit
    text[6] := (temp_fraction/10) mod 10 + 48;   // Extract
tens digit
    text[7] := temp_fraction mod 10 + 48;       // Extract
ones digit

    // print temperature on LCD
    Lcd_Out(2, 5, text);
end;

begin

```

```
Lcd_Init(); // Initialize LCD
Lcd_Cmd(LCD_CLEAR); // Clear LCD
Lcd_Cmd(LCD_CURSOR_OFF); // Turn cursor off
Lcd_Out(1, 1, ' Temperature: ');
// Print degree character, 'C' for Centigrades
Lcd_Chr(2,13,223);
Lcd_Chr(2,14,'C');

//--- main loop
while TRUE do
  begin
    //--- perform temperature reading
    Ow_Reset(); // Onewire reset signal
    Ow_Write(0xCC); // Issue command SKIP_ROM
    Ow_Write(0x44); // Issue command CONVERT_T
    Delay_us(120);

    Ow_Reset();
    Ow_Write(0xCC); // Issue command SKIP_ROM
    Ow_Write(0xBE); // Issue command READ_SCRATCHPAD

    temp := Ow_Read();
    temp := (Ow_Read() shl 8) + temp;

    //--- Format and display result on Lcd
    Display_Temperature(temp);

    Delay_ms(500);
  end;
end.
```

HW Connection

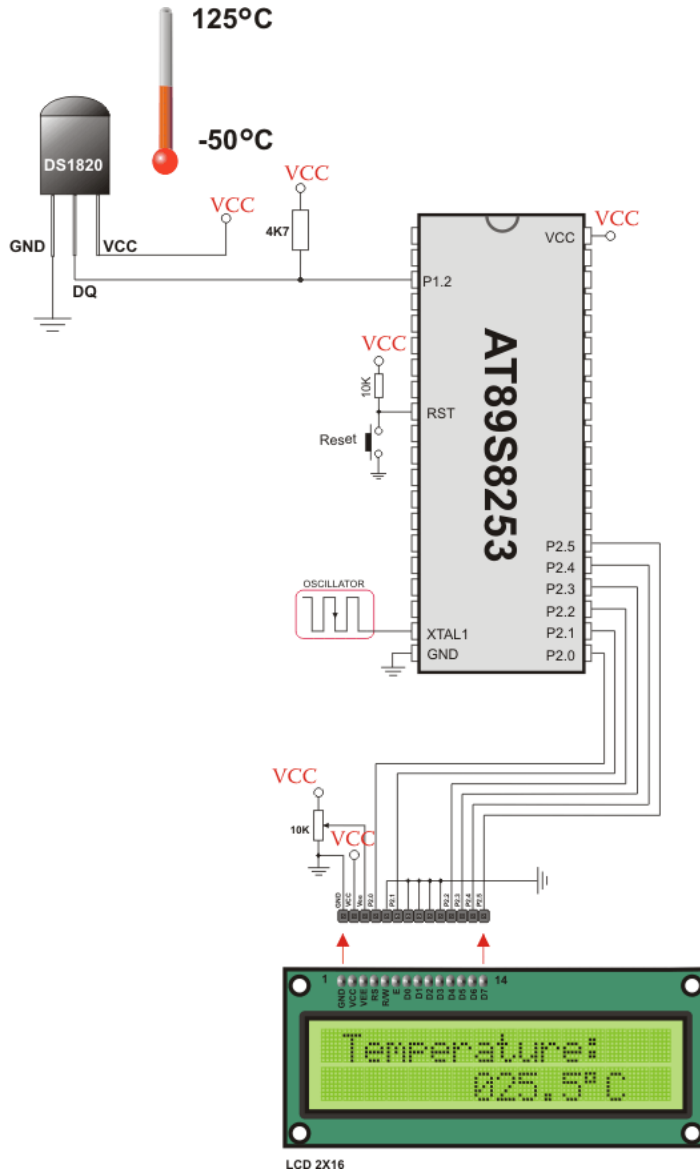

Example of DS1820 connection

MANCHESTER CODE LIBRARY

The *mikroPascal for 8051* provides a library for handling Manchester coded signals. The Manchester code is a code in which data and clock signals are combined to form a single self-synchronizing data stream; each encoded bit contains a transition at the midpoint of a bit period, the direction of transition determines whether the bit is 0 or 1; the second half is the true bit value and the first half is the complement of the true bit value (as shown in the figure below).

Manchester RF_Send_Byte format

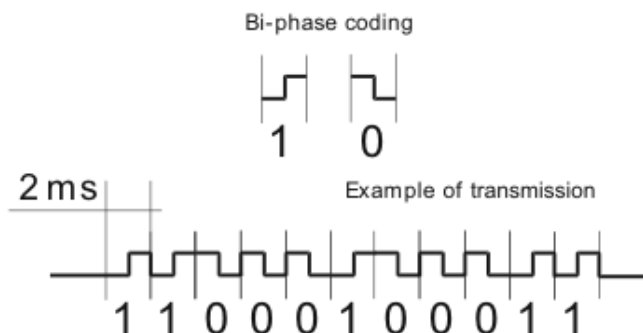
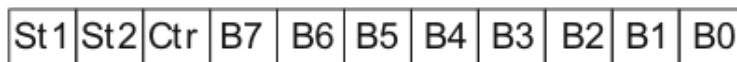

Notes: The Manchester receive routines are blocking calls ([Man_Receive_Init](#) and [Man_Synchro](#)). This means that MCU will wait until the task has been performed (e.g. byte is received, synchronization achieved, etc).

External dependencies of Manchester Code Library

The following variables must be defined in all projects using Manchester Code Library:	Description:	Example :
<code>var MANRXPIN : sbit; external;</code>	Receive line.	<code>var MANRXPIN : sbit at P0.B0;</code>
<code>var MANTXPIN : sbit; external;</code>	Transmit line.	<code>var MANTXPIN : sbit at P1.B1;</code>

Library Routines

- Man_Receive_Init
- Man_Receive
- Man_Send_Init
- Man_Send
- Man_Synchro
- Man_Out

The following routines are for the internal use by compiler only:

- Manchester_0
- Manchester_1
- Manchester_Out

Man_Receive_Init

Prototype	<code>function Man_Receive_Init(): word;</code>
Returns	<ul style="list-style-type: none"> - 0 - if initialization and synchronization were successful. - 1 - upon unsuccessful synchronization.
Description	<p>The function configures Receiver pin and performs synchronization procedure in order to retrieve baud rate out of the incoming signal.</p> <p>Note: In case of multiple persistent errors on reception, the user should call this routine once again or Man_Synchro routine to enable synchronization.</p>
Requires	<code>MANRXPIN</code> variable must be defined before using this function.
Example	<pre>// Initialize Receiver var MANRXPIN : sbit at P0.B0; ... Man_Receive_Init();</pre>

Man_Receive

Prototype	<code>function Man_Receive(var error: byte): byte;</code>
Returns	A byte read from the incoming signal.
Description	The function extracts one byte from incoming signal. Parameters : - <code>error</code> : error flag. If signal format does not match the expected, the <code>error</code> flag will be set to non-zero.
Requires	To use this function, the user must prepare the MCU for receiving. See <code>Man_Receive_Init</code> .
Example	<pre> var data, error : byte ... data := 0 error := 0 data := Man_Receive(&error); if (error <> 0) then begin // error handling end; </pre>

Man_Send_Init

Prototype	<code>procedure Man_Send_Init();</code>
Returns	Nothing.
Description	The function configures Transmitter pin.
Requires	<code>MANTXPIN</code> variable must be defined before using this function.
Example	<pre> // Initialize Transmitter: var MANTXPIN : sbit at P1.B1; ... Man_Send_Init(); </pre>

Man_Send

Prototype	<code>procedure Man_Send(tr_data: byte);</code>
Returns	Nothing.
Description	<p>Sends one byte.</p> <p>Parameters :</p> <ul style="list-style-type: none"> - <code>tr_data</code>: data to be sent <p>Note: Baud rate used is 500 bps.</p>
Requires	To use this function, the user must prepare the MCU for sending. See <code>Man_Send_Init</code> .
Example	<pre>var msg : byte; ... Man_Send(msg);</pre>

Man_Synchro

Prototype	<code>function Man_Synchro(): word;</code>
Returns	<ul style="list-style-type: none"> - 0 - if synchronization was not successful. - Half of the manchester bit length, given in multiples of 10us - upon successful synchronization.
Description	Measures half of the manchester bit length with 10us resolution.
Requires	To use this function, you must first prepare the MCU for receiving. See <code>Man_Receive_Init</code> .
Example	<pre>var man_half_bit_len : word ; ... man_half_bit_len := Man_Synchro();</pre>

Man_Out

Prototype	<code>procedure Man_Out(BitValue: byte);</code>
Returns	Nothing.
Description	Sends one byte in Manchester format. Parameters : - <code>BitValue</code> : data to be sent
Requires	To use this function, the user must prepare the MCU for sending. See <code>Man_Send_Init</code> .
Example	<code>var BitValue : byte;</code> <code>...</code> <code>Man_Out(BitValue);</code>

Library Example

The following code is code for the Manchester receiver, it shows how to use the Manchester Library for receiving data:

```

program Manchester_Receiver;

// LCD module connections
var LCD_RS : sbit at P2.B0;
var LCD_EN : sbit at P2.B1;

var LCD_D7 : sbit at P2.B5;
var LCD_D6 : sbit at P2.B4;
var LCD_D5 : sbit at P2.B3;
var LCD_D4 : sbit at P2.B2;
// End LCD module connections

// Manchester module connections
var MANRXPIN : sbit at P0.B0;
var MANTXPIN : sbit at P1.B1;
// End Manchester module connections

var error, ErrorCount, temp : byte;

begin
    ErrorCount := 0;

    Lcd_Init(); // Initialize LCD
    Lcd_Cmd(LCD_CLEAR); // Clear LCD display

```

```

Man_Receive_Init();           // Initialize Receiver

    while TRUE do           // Endless loop
    begin
        Lcd_Cmd(LCD_FIRST_ROW); // Move cursor to the 1st row

        while TRUE do      // Wait for the "start" byte
        begin
            temp := Man_Receive(error); // Attempt byte receive
            if (temp = 0x0B) then      // "Start" byte, see
Transmitter example
                exit;                // We got the starting sequence
            if (error <> 0) then // Exit so we do not loop forever
                exit;
        end;

        while ( temp <> 0x0E ) do
        begin
            temp := Man_Receive(error); // Attempt byte receive
            if (error <> 0) then      // If error occurred
                begin
                    Lcd_Chrcp('?'); // Write question mark on LCD
                    Inc(ErrorCount); // Update error counter
                    if (ErrorCount > 20) then // In case of
multiple errors
                        begin
                            temp := Man_Synchro(); // Try to syn-
chronize again
                            //Man_Receive_Init(); // Alternative,
try to Initialize Receiver again
                            ErrorCount := 0; // Reset error counter
                        end;
                    end
                else // No error occurred
                begin
                    if (temp <> 0x0E) then // If "End"
byte was received(see Transmitter example)
                        Lcd_Chrcp(temp); // do not
write received byte on LCD
                    end;
                    Delay_ms(25);
                end;
            end; // If "End" byte was received exit do loop
        end.

```

The following code is code for the Manchester transmitter, it shows how to use the Manchester Library for transmitting data:

```
program Manchester_Transmitter;

// Manchester module connections
var MANRXPIN : sbit at P0.B0;
var MANTXPIN : sbit at P1.B1;
// End Manchester module connections

var index, character : byte;
    s1 : array[16] of byte;

begin
    s1 := 'mikroElektronika';
    Man_Send_Init(); // Initialize transmitter

    while TRUE do // Endless loop
        begin
            Man_Send(0x0B); // Send "start" byte
            Delay_ms(100); // Wait for a while

            character := s1[0]; // Take first char from string
            index := 0; // Initialize index variable
            while (character <> 0) do // String ends with zero
                begin
                    Man_Send(character); // Send character
                    Delay_ms(90); // Wait for a while
                    Inc(index); // Increment index variable
                    character := s1[index]; // Take next char from string
                end;
            Man_Send(0x0E); // Send "end" byte
            Delay_ms(1000);
        end;
    end.
```

Connection Example

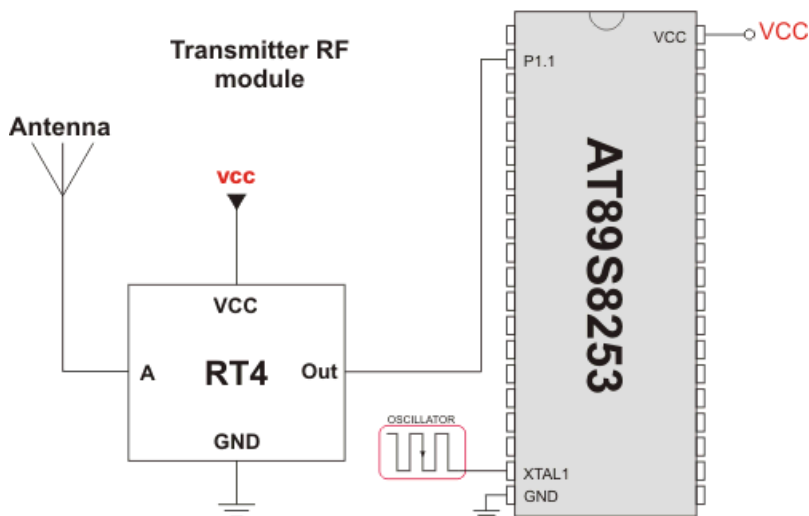

Simple Transmitter connection

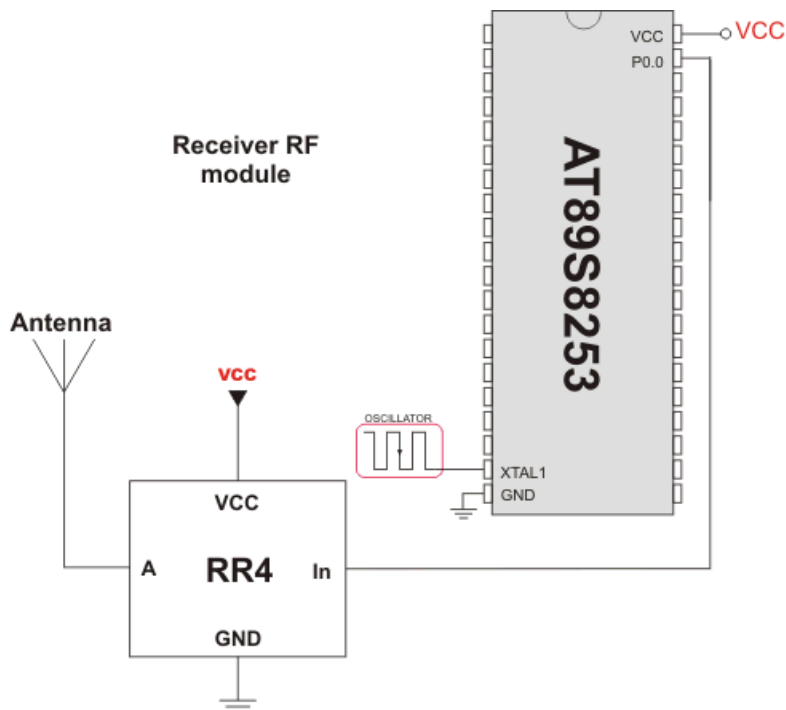

Simple Receiver connection

PORT EXPANDER LIBRARY

The *mikroPascal for 8051* provides a library for communication with the Microchip's Port Expander MCP23S17 via SPI interface. Connections of the 8051 compliant MCU and MCP23S17 is given on the schematic at the bottom of this page.

Note: Library uses the SPI module for communication. The user must initialize SPI module before using the Port Expander Library.

Note: Library does not use Port Expander interrupts.

External dependencies of Port Expander Library

The following variables must be defined in all projects using Port Expander Library:	Description:	Example :
<code>var SPExpanderCS : sbit; external;</code>	Chip Select line.	<code>var SPExpanderCS : sbit at P1.B1;</code>
<code>var SPExpanderRST : sbit; external;</code>	Reset line.	<code>var SPExpanderRST : sbit at P1.B0;</code>

Library Routines

- Expander_Init
- Expander_Read_Byte
- Expander_Write_Byte
- Expander_Read_PortA
- Expander_Read_PortB
- Expander_Read_PortAB
- Expander_Write_PortA
- Expander_Write_PortB
- Expander_Write_PortAB
- Expander_Set_DirectionPortA
- Expander_Set_DirectionPortB
- Expander_Set_DirectionPortAB
- Expander_Set_PullUpsPortA
- Expander_Set_PullUpsPortB
- Expander_Set_PullUpsPortAB

Expander_Init

Prototype	<code>procedure Expander_Init(ModuleAddress : byte);</code>
Returns	Nothing.
Description	<p>Initializes Port Expander using SPI communication.</p> <p>Port Expander module settings :</p> <ul style="list-style-type: none">- hardware addressing enabled- automatic address pointer incrementing disabled (byte mode)- BANK_0 register addressing- slew rate enabled <p>Parameters :</p> <ul style="list-style-type: none">- <code>ModuleAddress</code>: Port Expander hardware address, see schematic at the bottom of this page
Requires	<p><code>SPExpanderCS</code> and <code>SPExpanderRST</code> variables must be defined before using this function.</p> <p>SPI module needs to be initialized. See <code>Spi_Init</code> and <code>Spi_Init_Advanced</code> routines.</p>
Example	<pre>// port expander pinout definition var SPExpanderCS : sbit at P1.B1; SPExpanderRST : sbit at P1.B0; ... Spi_Init(); // initialize SPI module Expander_Init(0); // initialize port expander</pre>

Expander_Read_Byte

Prototype	<code>function Expander_Read_Byte (ModuleAddress : byte; RegAddress : byte) : byte;</code>
Returns	Byte read.
Description	The function reads byte from Port Expander. Parameters : - <code>ModuleAddress</code> : Port Expander hardware address, see schematic at the bottom of this page - <code>RegAddress</code> : Port Expander's internal register address
Requires	Port Expander must be initialized. See <code>Expander_Init</code> .
Example	<pre>// Read a byte from Port Expander's register var read_data : byte; ... read_data := Expander_Read_Byte(0,1);</pre>

Expander_Write_Byte

Prototype	<code>procedure Expander_Write_Byte (ModuleAddress: byte; RegAddress: byte; Data_: byte);</code>
Returns	Nothing.
Description	Routine writes a byte to Port Expander. Parameters : - <code>ModuleAddress</code> : Port Expander hardware address, see schematic at the bottom of this page - <code>RegAddress</code> : Port Expander's internal register address - <code>Data_</code> : data to be written
Requires	Port Expander must be initialized. See <code>Expander_Init</code> .
Example	<pre>// Write a byte to the Port Expander's register Expander_Write_Byte(0,1,0xFF);</pre>

Expander_Read_PortA

Prototype	<code>function Expander_Read_PortA(ModuleAddress: byte): byte;</code>
Returns	Byte read.
Description	The function reads byte from Port Expander's PortA. Parameters : - <code>ModuleAddress</code> : Port Expander hardware address, see schematic at the bottom of this page
Requires	Port Expander must be initialized. See <code>Expander_Init</code> . Port Expander's PortA should be configured as input. See <code>Expander_Set_DirectionPortA</code> and <code>Expander_Set_DirectionPortAB</code> routines.
Example	<pre>// Read a byte from Port Expander's PORTA var read_data : byte; ... Expander_Set_DirectionPortA(0,0xFF); // set expander's porta to be input ... read_data := Expander_Read_PortA(0);</pre>

Expander_Read_PortB

Prototype	<code>function Expander_Read_PortB(ModuleAddress: byte): byte;</code>
Returns	Byte read.
Description	The function reads byte from Port Expander's PortB. Parameters : - <code>ModuleAddress</code> : Port Expander hardware address, see schematic at the bottom of this page
Requires	Port Expander must be initialized. See <code>Expander_Init</code> . Port Expander's PortB should be configured as input. See <code>Expander_Set_DirectionPortB</code> and <code>Expander_Set_DirectionPortAB</code> routines.
Example	<pre>// Read a byte from Port Expander's PORTB var read_data : byte; ... Expander_Set_DirectionPortB(0,0xFF); // set expander's portb to be input ... read_data := Expander_Read_PortB(0);</pre>

Expander_Read_PortAB

Prototype	<code>function Expander_Read_PortAB(ModuleAddress: byte): word;</code>
Returns	Word read.
Description	<p>The function reads word from Port Expander's ports. PortA readings are in the higher byte of the result. PortB readings are in the lower byte of the result.</p> <p>Parameters :</p> <ul style="list-style-type: none"> - <code>ModuleAddress</code>: Port Expander hardware address, see schematic at the bottom of this page
Requires	<p>Port Expander must be initialized. See <code>Expander_Init</code>.</p> <p>Port Expander's PortA and PortB should be configured as inputs. See <code>Expander_Set_DirectionPortA</code>, <code>Expander_Set_DirectionPortB</code> and <code>Expander_Set_DirectionPortAB</code> routines.</p>
Example	<pre>// Read a byte from Port Expander's PORTA and PORTB var read_data : word; ... Expander_Set_DirectionPortAB(0,0xFFFF); // set expander's porta and portb to be input ... read_data := Expander_Read_PortAB(0);</pre>

Expander_Write_PortA

Prototype	<code>procedure Expander_Write_PortA(ModuleAddress: byte; Data_: byte);</code>
Returns	Nothing.
Description	<p>The function writes byte to Port Expander's PortA.</p> <p>Parameters :</p> <ul style="list-style-type: none"> - <code>ModuleAddress</code>: Port Expander hardware address, see schematic at the bottom of this page - <code>Data_</code>: data to be written
Requires	<p>Port Expander must be initialized. See <code>Expander_Init</code>.</p> <p>Port Expander's PortA should be configured as output. See <code>Expander_Set_DirectionPortA</code> and <code>Expander_Set_DirectionPortAB</code> routines.</p>
Example	<pre>// Write a byte to Port Expander's PORTA ... Expander_Set_DirectionPortA(0,0x00); // set expander's porta to be output ... Expander_Write_PortA(0, 0xAA);</pre>

Expander_Write_PortB

Prototype	<code>procedure Expander_Write_PortB(ModuleAddress: byte; Data_: byte);</code>
Returns	Nothing.
Description	<p>The function writes byte to Port Expander's PortB.</p> <p>Parameters :</p> <ul style="list-style-type: none"> - <code>ModuleAddress</code>: Port Expander hardware address, see schematic at the bottom of this page - <code>Data_</code>: data to be written
Requires	<p>Port Expander must be initialized. See <code>Expander_Init</code>.</p> <p>Port Expander's PortB should be configured as output. See <code>Expander_Set_DirectionPortB</code> and <code>Expander_Set_DirectionPortAB</code> routines.</p>
Example	<pre>// Write a byte to Port Expander's PORTB ... Expander_Set_DirectionPortB(0,0x00); // set expander's portb to be output ... Expander_Write_PortB(0, 0x55);</pre>

Expander_Write_PortAB

Prototype	<code>procedure Expander_Write_PortAB(ModuleAddress: byte; Data_: word);</code>
Returns	Nothing.
Description	<p>The function writes word to Port Expander's ports.</p> <p>Parameters :</p> <ul style="list-style-type: none"> - <code>ModuleAddress</code>: Port Expander hardware address, see schematic at the bottom of this page - <code>Data_</code>: data to be written. Data to be written to PortA are passed in Data's higher byte. Data to be written to PortB are passed in Data's lower byte
Requires	<p>Port Expander must be initialized. See <code>Expander_Init</code>.</p> <p>Port Expander's PortA and PortB should be configured as outputs. See <code>Expander_Set_DirectionPortA</code>, <code>Expander_Set_DirectionPortB</code> and <code>Expander_Set_DirectionPortAB</code> routines.</p>
Example	<pre>// Write a byte to Port Expander's PORTA and PORTB ... Expander_Set_DirectionPortAB(0,0x0000); // set expander's porta and portb to be output ... Expander_Write_PortAB(0, 0xAA55);</pre>

Expander_Set_DirectionPortA

Prototype	<code>procedure Expander_Set_DirectionPortA(ModuleAddress: byte; Data_: byte);</code>
Returns	Nothing.
Description	<p>The function sets Port Expander's PortA direction.</p> <p>Parameters :</p> <ul style="list-style-type: none"> - <code>ModuleAddress</code>: Port Expander hardware address, see schematic at the bottom of this page - <code>Data_</code>: data to be written to the PortA direction register. Each bit corresponds to the appropriate pin of the PortA register. Set bit designates corresponding pin as input. Cleared bit designates corresponding pin as output.
Requires	Port Expander must be initialized. See <code>Expander_Init</code> .
Example	<pre>// Set Port Expander's PORTA to be output Expander_Set_DirectionPortA(0,0x00);</pre>

Expander_Set_DirectionPortB

Prototype	<code>procedure Expander_Set_DirectionPortB(ModuleAddress: byte; Data_: byte);</code>
Returns	Nothing.
Description	<p>The function sets Port Expander's PortB direction.</p> <p>Parameters :</p> <ul style="list-style-type: none"> - <code>ModuleAddress</code>: Port Expander hardware address, see schematic at the bottom of this page - <code>Data_</code>: data to be written to the PortB direction register. Each bit corresponds to the appropriate pin of the PortB register. Set bit designates corresponding pin as input. Cleared bit designates corresponding pin as output.
Requires	Port Expander must be initialized. See <code>Expander_Init</code> .
Example	<pre>// Set Port Expander's PORTB to be input Expander_Set_DirectionPortB(0,0xFF);</pre>

Expander_Set_DirectionPortAB

Prototype	<code>procedure Expander_Set_DirectionPortAB(ModuleAddress: byte; Direction: word);</code>
Returns	Nothing.
Description	<p>The function sets Port Expander's PortA and PortB direction.</p> <p>Parameters :</p> <ul style="list-style-type: none"> - <code>ModuleAddress</code>: Port Expander hardware address, see schematic at the bottom of this page - <code>Direction</code>: data to be written to direction registers. Data to be written to the PortA direction register are passed in <code>Direction</code>'s higher byte. Data to be written to the PortB direction register are passed in <code>Direction</code>'s lower byte. Each bit corresponds to the appropriate pin of the PortA/PortB register. Set bit designates corresponding pin as input. Cleared bit designates corresponding pin as output.
Requires	Port Expander must be initialized. See <code>Expander_Init</code> .
Example	<code>// Set Port Expander's PORTA to be output and PORTB to be input Expander_Set_DirectionPortAB(0,0x00FF);</code>

Expander_Set_PullUpsPortA

Prototype	<code>procedure Expander_Set_PullUpsPortA(ModuleAddress: byte; Data_: byte);</code>
Returns	Nothing.
Description	<p>The function sets Port Expander's PortA pull up/down resistors.</p> <p>Parameters :</p> <ul style="list-style-type: none"> - <code>ModuleAddress</code>: Port Expander hardware address, see schematic at the bottom of this page - <code>Data_</code>: data for choosing pull up/down resistors configuration. Each bit corresponds to the appropriate pin of the PortA register. Set bit enables pull-up for corresponding pin.
Requires	Port Expander must be initialized. See <code>Expander_Init</code> .
Example	<code>// Set Port Expander's PORTA pull-up resistors Expander_Set_PullUpsPortA(0, 0xFF);</code>

Expander_Set_PullUpsPortB

Prototype	<code>procedure Expander_Set_PullUpsPortB(ModuleAddress: byte; Data_: byte);</code>
Returns	Nothing.
Description	<p>The function sets Port Expander's PortB pull up/down resistors.</p> <p>Parameters :</p> <ul style="list-style-type: none"> - <code>ModuleAddress</code>: Port Expander hardware address, see schematic at the bottom of this page - <code>Data_</code>: data for choosing pull up/down resistors configuration. Each bit corresponds to the appropriate pin of the PortB register. Set bit enables pull-up for corresponding pin.
Requires	Port Expander must be initialized. See <code>Expander_Init</code> .
Example	<pre>// Set Port Expander's PORTB pull-up resistors Expander_Set_PullUpsPortB(0, 0xFF);</pre>

Expander_Set_PullUpsPortAB

Prototype	<code>procedure Expander_Set_PullUpsPortAB(ModuleAddress: byte; PullUps: word);</code>
Returns	Nothing.
Description	<p>The function sets Port Expander's PortA and PortB pull up/down resistors.</p> <p>Parameters :</p> <ul style="list-style-type: none"> - <code>ModuleAddress</code>: Port Expander hardware address, see schematic at the bottom of this page - <code>PullUps</code>: data for choosing pull up/down resistors configuration. PortA pull up/down resistors configuration is passed in <code>PullUps</code>'s higher byte. PortB pull up/down resistors configuration is passed in <code>PullUps</code>'s lower byte. Each bit corresponds to the appropriate pin of the PortA/PortB register. Set bit enables pull-up for corresponding pin.
Requires	Port Expander must be initialized. See <code>Expander_Init</code> .
Example	<pre>// Set Port Expander's PORTA and PORTB pull-up resistors Expander_Set_PullUpsPortAB(0, 0xFFFF);</pre>

Library Example

The example demonstrates how to communicate with Port Expander MCP23S17.

Note that Port Expander pins A2 A1 A0 are connected to GND so Port Expander Hardware Address is 0.

```
program PortExpander;

var i : byte;

// Port Expander module connections
var SPExpanderRST : sbit at P1.B0;
var SPExpanderCS : sbit at P1.B1;
// End Port Expander module connections

begin
  i := 0;
  Spi_Init(); // Initialize SPI module

  Expander_Init(0); // Initialize Port Expander

  Expander_Set_DirectionPortA(0, 0x00); // Set Expander's
PORTA to be output

  Expander_Set_DirectionPortB(0,0xFF); // Set Expander's
PORTB to be input
  Expander_Set_PullUpsPortB(0,0xFF); // Set pull-ups to
all of the Expander's PORTB pins

  while TRUE do // Endless loop
    begin
      Expander_Write_PortA(0, i); // Write i to
expander's PORTA
      Inc(i);
      P0 := Expander_Read_PortB(0); // Read expander's
PORTB and write it to PORT0
      Delay_ms(100);
    end;
end.
```

HW Connection

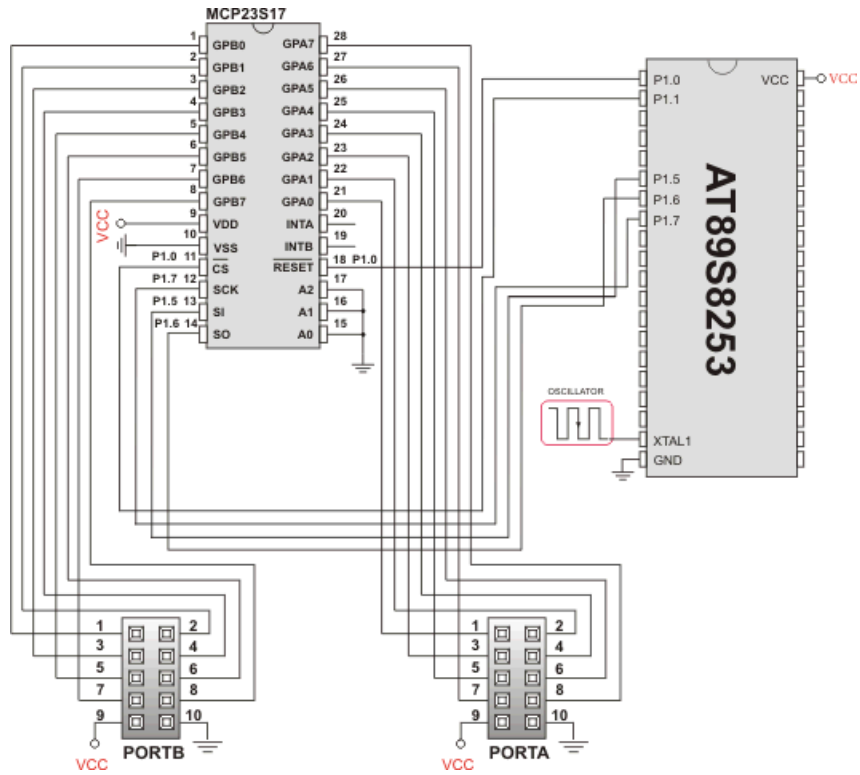

Port Expander HW connection

PS/2 LIBRARY

The *mikroPascal for 8051* provides a library for communication with the common PS/2 keyboard.

Note: The library does not utilize interrupts for data retrieval, and requires the oscillator clock to be at least 6MHz.

Note: The pins to which a PS/2 keyboard is attached should be connected to the pull-up resistors.

Note: Although PS/2 is a two-way communication bus, this library does not provide MCU-to-keyboard communication; e.g. pressing the Caps Lock key will not turn on the Caps Lock LED.

External dependencies of PS/2 Library

The following variables must be defined in all projects using PS/2 Library:	Description:	Example :
<code>var PS2_DATA: sbit; external;</code>	PS/2 Data line.	<code>var PS2_DATA: sbit at P0.B0;</code>
<code>var PS2_CLOCK: sbit; external;</code>	PS/2 Clock line.	<code>var PS2_CLOCK: sbit at P0.B1;</code>

Library Routines

- Ps2_Config
- Ps2_Key_Read

Ps2_Config

Prototype	<code>procedure Ps2_Config();</code>
Returns	Nothing.
Description	Initializes the MCU for work with the PS/2 keyboard.
Requires	Global variables : <ul style="list-style-type: none"> - <code>PS2_DATA</code> : Data signal pin - <code>PS2_CLOCK</code> : Clock signal pin <p>must be defined before using this function.</p>
Example	<pre>// PS2 pinout definition var PS2_DATA : sbit at P0.B0; PS2_CLOCK : sbit at P0.B1; ... Ps2_Config(); // Init PS/2 Keyboard</pre>

Ps2_Key_Read

Prototype	<code>function Ps2_Key_Read(var value: byte; var special: byte; var pressed: byte): byte;</code>
Returns	<ul style="list-style-type: none"> - 1 if reading of a key from the keyboard was successful - 0 if no key was pressed
Description	<p>The function retrieves information on key pressed.</p> <p>Parameters :</p> <ul style="list-style-type: none"> - <code>value</code>: holds the value of the key pressed. For characters, numerals, punctuation marks, and space <code>value</code> will store the appropriate ASCII code. Routine “recognizes” the function of Shift and Caps Lock, and behaves appropriately. For special function keys see Special Function Keys Table. - <code>special</code>: is a flag for special function keys (F1, Enter, Esc, etc). If key pressed is one of these, <code>special</code> will be set to 1, otherwise 0. - <code>pressed</code>: is set to 1 if the key is pressed, and 0 if it is released.
Requires	PS/2 keyboard needs to be initialized. See Ps2_Config routine.
Example	<pre>var value, special, pressed: byte; ... // Press Enter to continue: repeat if (Ps2_Key_Read(value, special, pressed)) then if ((value = 13) and (special = 1)) then break; until (0=1);</pre>

Special Function Keys

Key	Value returned
F1	1
F2	2
F3	3
F4	4
F5	5
F6	6
F7	7
F8	8
F9	9
F10	10
F11	11
F12	12
Enter	13
Page Up	14
Page Down	15
Backspace	16
Insert	17
Delete	18
Windows	19
Ctrl	20
Shift	21
Alt	22
Print Screen	23
Pause	24
Caps Lock	25
End	26
Home	27
Scroll Lock	28

Num Lock	29
Left Arrow	30
Right Arrow	31
Up Arrow	32
Down Arrow	33
Escape	34
Tab	35

Library Example

This simple example reads values of the pressed keys on the PS/2 keyboard and sends them via UART.

```
program PS2_Example;

var keydata, special, down : byte;

// PS2 module connections
var PS2_DATA : sbit at P0.B0;
    PS2_CLOCK : sbit at P0.B1;
// End PS2 module connections

begin
    keydata := 0;
    special := 0;
    down := 0;
    Uart_Init(4800);           // Initialize UART module at 4800 bps
    Ps2_Config();            // Initialize PS/2 Keyboard
    Delay_ms(100);           // Wait for keyboard to finish

    while TRUE do           // Endless loop
    begin
        if (Ps2_Key_Read( keydata, special, down)) then // If data
was read from PS/2
            begin
                if (down and (keydata = 16)) then // Backspace read
                    Uart_Write(0x08) // Send Backspace to usart terminal

                else
                    if (down and (keydata = 13)) then // Enter read
                        Uart_Write(13) // Send
carriage return to usart terminal
                        //Uart_Write(10); // Uncomment
this line if usart terminal also expects line feed
                        // for new line transition

                    else
                        if (down and not special and keydata) then // Common
key read
                            Uart_Write(keydata); // Send key to usart terminal

                        end;
                        Delay_ms(10); // Debounce period
                    end;
                end.
            end.
    end.
end.
```

HW Connection

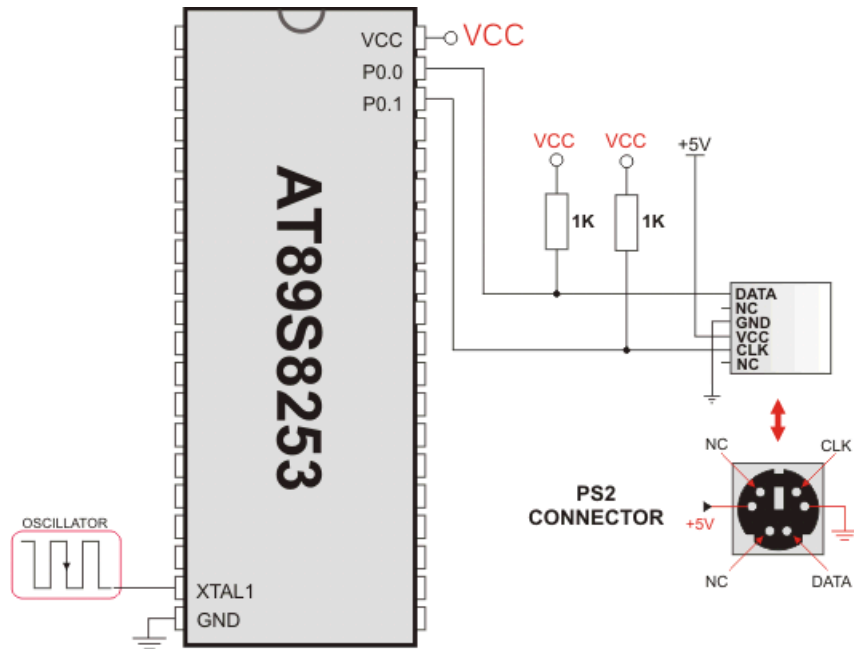

Example of PS2 keyboard connection

RS-485 LIBRARY

RS-485 is a multipoint communication which allows multiple devices to be connected to a single bus. The *mikroPascal for 8051* provides a set of library routines for comfortable work with RS485 system using Master/Slave architecture. Master and Slave devices interchange packets of information. Each of these packets contains synchronization bytes, CRC byte, address byte and the data. Each Slave has unique address and receives only packets addressed to it. The Slave can never initiate communication.

It is the user's responsibility to ensure that only one device transmits via 485 bus at a time.

The RS-485 routines require the UART module. Pins of UART need to be attached to RS-485 interface transceiver, such as LTC485 or similar (see schematic at the bottom of this page).

Library constants:

- START byte value = 150
- STOP byte value = 169
- Address 50 is the broadcast address for all Slaves (packets containing address 50 will be received by all Slaves except the Slaves with addresses 150 and 169).

External dependencies of RS-485 Library

The following variable must be defined in all projects using RS-485 Library:	Description:	Example :
<pre>var rs485_transceive: sbit; external;</pre>	Control RS-485 Transmit/Receive operation mode	<pre>var rs485_transceive: sbit at P3.B2;</pre>

Library Routines

- RS485master_Init
- RS485master_Receive
- RS485master_Send
- RS485slave_Init
- RS485slave_Receive
- RS485slave_Send

RS485master_Init

Prototype	<code>procedure Rs485master_Init();</code>
Returns	Nothing.
Description	Initializes MCU as a Master for RS-485 communication.
Requires	<p><code>rs485_transceive</code> variable must be defined before using this function. This pin is connected to RE/DE input of RS-485 transceiver(see schematic at the bottom of this page). RE/DE signal controls RS-485 transceiver operation mode. Valid values: 1 (for transmitting) and 0 (for receiving)</p> <p>UART HW module needs to be initialized. See <code>Uart_Init</code>.</p>
Example	<pre>// rs485 module pinout var rs485_transceive : sbit at P3.B2; // transmit/receive control set to port3.bit2 ... Uart_Init(9600); // initialize usart module Rs485master_Init(); // intialize mcu as a Master for RS-485 communication</pre>

RS485master_Receive

Prototype	<code>procedure Rs485master_Receive(var data_buffer: array[20] of byte);</code>
Returns	Nothing.
Description	<p>Receives messages from Slaves. Messages are multi-byte, so this routine must be called for each byte received.</p> <p>Parameters :</p> <ul style="list-style-type: none"> - <code>data_buffer</code>: 7 byte buffer for storing received data, in the following manner: - <code>data[0..2]</code> : message content - <code>data[3]</code> : number of message bytes received, 1–3 - <code>data[4]</code> : is set to 255 when message is received - <code>data[5]</code> : is set to 255 if error has occurred - <code>data[6]</code> : address of the Slave which sent the message <p>The function automatically adjusts <code>data[4]</code> and <code>data[5]</code> upon every received message. These flags need to be cleared by software.</p>
Requires	MCU must be initialized as a Master for RS-485 communication. See <code>RS485master_Init</code> .
Example	<pre>var msg : array[20] of byte; ... RS485master_Receive(msg);</pre>

RS485master_Send

Prototype	<code>procedure Rs485master_Send(var data_buffer: array[20] of byte; datalen: byte; slave_address: byte);</code>
Returns	Nothing.
Description	<p>Sends message to Slave(s). Message format can be found at the bottom of this page.</p> <p>Parameters :</p> <ul style="list-style-type: none"> - <code>data_buffer</code>: data to be sent - <code>datalen</code>: number of bytes for transmission. Valid values: 0...3. - <code>slave_address</code>: Slave(s) address
Requires	<p>MCU must be initialized as a Master for RS-485 communication. See <code>RS485master_Init</code>.</p> <p>It is the user's responsibility to ensure (by protocol) that only one device sends data via 485 bus at a time.</p>
Example	<pre>var msg : array[20] of byte; ... // send 3 bytes of data to slave with address 0x12 RS485master_Send(msg, 3, 0x12);</pre>

RS485slave_Init

Prototype	<code>procedure Rs485slave_Init(slave_address: byte);</code>
Returns	Nothing.
Description	<p>Initializes MCU as a Slave for RS-485 communication.</p> <p>Parameters :</p> <ul style="list-style-type: none"> - <code>slave_address</code>: Slave address
Requires	<p><code>rs485_transceive</code> variable must be defined before using this function. This pin is connected to RE/DE input of RS-485 transceiver(see schematic at the bottom of this page). RE/DE signal controls RS-485 transceiver operation mode. Valid values: 1 (for transmitting) and 0 (for receiving)</p> <p>UART HW module needs to be initialized. See <code>Uart_Init</code>.</p>
Example	<pre>// rs485 module pinout var rs485_transceive : sbit at P3.B2; // transmit/receive control set to port3.bit2 ... Uart_Init(9600); // initialize usart module Rs485slave_Init(160); // intialize mcu as a Slave for RS-485 communication with address 160</pre>

RS485slave_Receive

Prototype	<code>procedure RS485slave_Receive(var data_buffer: array[20] of byte);</code>
Returns	Nothing.
Description	<p>Receives messages from Master. If Slave address and Message address field don't match then the message will be discarded. Messages are multi-byte, so this routine must be called for each byte received.</p> <p>Parameters :</p> <ul style="list-style-type: none"> - <code>data_buffer</code>: 6 byte buffer for storing received data, in the following manner: - <code>data[0..2]</code> : message content - <code>data[3]</code> : number of message bytes received, 1–3 - <code>data[4]</code> : is set to 255 when message is received - <code>data[5]</code> : is set to 255 if error has occurred <p>The function automatically adjusts <code>data[4]</code> and <code>data[5]</code> upon every received message. These flags need to be cleared by software.</p>
Requires	MCU must be initialized as a Slave for RS-485 communication. See <code>RS485slave_Init</code> .
Example	<pre>var msg : array[20] of byte; ... RS485slave_Read(msg);</pre>

RS485slave_Send

Prototype	<code>procedure Rs485slave_Send(var data_buffer: array[20] of byte; datalen : byte);</code>
Returns	Nothing.
Description	Sends message to Master. Message format can be found at the bottom of this page. Parameters : - <code>data_buffer</code> : data to be sent - <code>datalen</code> : number of bytes for transmission. Valid values: 0...3.
Requires	MCU must be initialized as a Slave for RS-485 communication. See <code>RS485slave_Init</code> . It is the user's responsibility to ensure (by protocol) that only one device sends data via 485 bus at a time.
Example	<pre>var msg : array[8] of byte; ... // send 2 bytes of data to the master RS485slave_Send(msg, 2);</pre>

Library Example

This is a simple demonstration of RS485 Library routines usage.

Master sends message to Slave with address 160 and waits for a response. The Slave accepts data, increments it and sends it back to the Master. Master then does the same and sends incremented data back to Slave, etc.

Master displays received data on P0, while error on receive (0xAA) and number of consecutive unsuccessful retries are displayed on P1. Slave displays received data on P0, while error on receive (0xAA) is displayed on P1. Hardware configurations in this example are made for the Easy8051B board and AT89S8253.

RS485 Master code:

```

program RS485_Master;

uses __Lib_UART_t1;

var dat : array[ 10] of byte ; // Buffer for receving/sending messages
      counter, j : byte;
      count : longint;

// RS485 module connections
var rs485_transceive : sbit at P3.B2;           // Transmit/Receive
      control set to P3.2
// End RS485 module connections

//----- Interrupt routine
procedure UartRxHandler(); ORG 0x23;
begin
  EA := 0;           // Clear global interrupt enable flag
  if ( RI <> 0 ) then // Test UART receive interrupt flag
    begin
      Rs485master_Receive(dat); // UART receive interrupt detected,
      // receive data using RS485 communication
      RI := 0;           // Clear UART interrupt flag
    end;
  EA := 1;           // Set global interrupt enable flag
end;

begin
  count := 0;
  P0 := 0;           // Clear ports
  P1 := 0;

  Uart_Init(9600); // Initialize UART module at 9600 bps
  Delay_ms(100);

  Rs485master_Init(); // Intialize MCU as RS485 master
  dat[ 0] := 0x55;    // Fill buffer
  dat[ 1] := 0x00;
  dat[ 2] := 0x00;
  dat[ 4] := 0;      // Ensure that message received flag is 0
  dat[ 5] := 0;      // Ensure that error flag is 0
  dat[ 6] := 0;
  Rs485master_Send(dat,1,160); // Send message to slave with
  address 160
                                     // message data is stored in dat
                                     // message is 1 byte long

```

```

ES := 1;                                // Enable UART interrupt
RI := 0;                                // Clear UART RX interrupt flag
EA := 1;                                // Enable interrupts

while TRUE do                            // Endless loop
begin                                     // Upon completed valid message receiving
    Inc(count);                           // data[ 4 ] is set to 255
                                           // Increment loop pass counter

    if (dat[ 5] <> 0) then                // If error detected, signal it by
        P1 := 0xAA;                       // setting PORT1 to 0xAA

    if (dat[ 4] <> 0) then                // If message received successfully
begin
    count := 0;                            // Reset loop pass counter
    dat[ 4] := 0;                          // Clear message received flag
    j := dat[ 3];                          // Read number of message received bytes
    for counter := 1 to j do
        P0 := dat[counter-1];             // Show received data on PORT0

        dat[ 0] := dat[ 0] + 1;           // Increment first
received byte dat[ 0]

        Delay_ms(10);
        Rs485master_Send(dat,1,160);      // And send it back
to Slave
    end;

    if ( count > 10000 ) then              // If loop is passed
100000 times with
begin                                     // no message received
    Inc(P1);                               // Signal receive message failure on PORT1
    count := 0;                            // Reset loop pass counter
    Rs485master_Send(dat,1,160);          // Retry send message
    if (P1 > 10) then                       // If sending failed 10 times
begin
        P1 := 0;                          // Clear PORT1
        Rs485master_Send(dat,1,50);        // Send message on
broadcast address
    end;
end;
end;
end.

```

RS485 Slave code:

```
program RS485_Slave;

uses __Lib_UART_t1;

var dat : array[ 9] of byte; // Buffer for receving/sending messages
    counter, j : byte;

// RS485 module connections
var rs485_transceive : sbit at P3.B2; // Transmit/Receive control
set to P3.2
// End RS485 module connections

//----- Interrupt routine
procedure UartRxHandler(); ORG 0x23;
begin
    EA := 0; // Clear global interrupt enable flag
    if( RI <> 0) then // Test UART receive interrupt flag
        begin
            Rs485slave_Receive(dat); // UART receive interrupt detected,
            // receive data using RS485 communication
            RI := 0; // Clear UART interrupt flag
        end;
    EA := 1; // Set global interrupt enable flag
end;

begin
    P0 := 0; // Clear ports
    P1 := 0;

    Uart_Init(9600); // Initialize UART module at 9600 bps
    Delay_ms(100);
    Rs485slave_Init(160); // Intialize MCU as slave, address 160
    dat[ 4] := 0; // ensure that message received flag is 0
    dat[ 5] := 0; // ensure that error flag is 0

    ES := 1; // Enable UART interrupt
    RI := 0; // Clear UART RX interrupt flag
    EA := 1; // Enable interrupts

    while TRUE do // Endless loop
        begin

            // Upon completed valid message receiving
            // data[ 4] is set to 255
            if ( dat[ 5] <> 0) then // If error detected, signal it by
                P1 := 0xAA; // setting PORT1 to 0xAA
```



```

if (dat[ 4] <> 0) then           // If message received successfully
begin
  dat[ 4] := 0;                    // Clear message received flag
  j := dat[ 3];                    // Read number of message received bytes
  for counter := 1 to j do
    P0 := dat[ counter-1];        // Show received data on PORT0
    dat[ 0] := dat[ 0] + 1;       // Increment received dat[ 0]
    Delay_ms(10);
    Rs485slave_Send(dat,1);       // And send back to Master
  end;
end;
end.

```

HW Connection

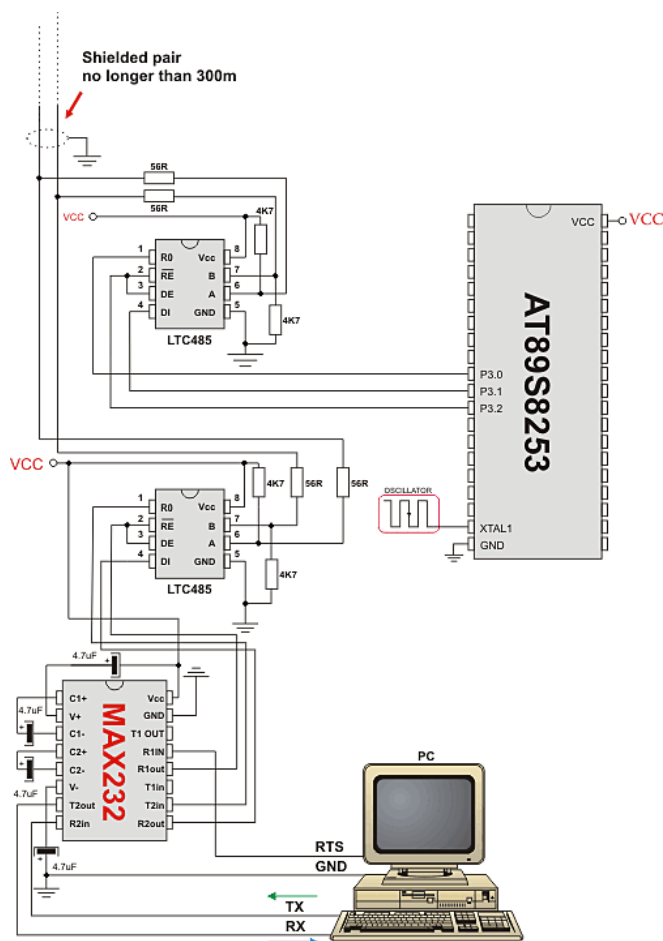

Example of interfacing PC to 8051 MCU via RS485 bus with LTC485 as RS-485 transceiver

Message format and CRC calculations

Q: How is CRC checksum calculated on RS485 master side?

```
START_BYTE := 0x96; // 10010110
STOP_BYTE  := 0xA9; // 10101001

PACKAGE:
-----
START_BYTE 0x96
ADDRESS
DATALEN
[ DATA1]           // if exists
[ DATA2]           // if exists
[ DATA3]           // if exists
CRC
STOP_BYTE  0xA9

DATALEN bits
-----
bit7 := 1 MASTER SENDS
      0 SLAVE SENDS
bit6 := 1 ADDRESS WAS XORed with 1, IT WAS EQUAL TO START_BYTE or
STOP_BYTE
      0 ADDRESS UNCHANGED
bit5 := 0 FIXED
bit4 := 1 DATA3 (if exists) WAS XORed with 1, IT WAS EQUAL TO
START_BYTE or STOP_BYTE
      0 DATA3 (if exists) UNCHANGED
bit3 := 1 DATA2 (if exists) WAS XORed with 1, IT WAS EQUAL TO
START_BYTE or STOP_BYTE
      0 DATA2 (if exists) UNCHANGED
bit2 := 1 DATA1 (if exists) WAS XORed with 1, IT WAS EQUAL TO
START_BYTE or STOP_BYTE
      0 DATA1 (if exists) UNCHANGED
bit1bit0 := 0 to 3 NUMBER OF DATA BYTES SEND

CRC generation :
-----
crc_send := datalen xor address;
crc_send := crc_send xor data[0]; // if exists
crc_send := crc_send xor data[1]; // if exists
crc_send := crc_send xor data[2]; // if exists
crc_send := not crc_send;
if ((crc_send = START_BYTE) or (crc_send = STOP_BYTE)) then
    Inc(crc_send);

NOTE: DATALEN<4..0> can not take the START_BYTE<4..0> or
STOP_BYTE<4..0> values.
```

SOFTWARE I²C LIBRARY

The *mikroPascal for 8051* provides routines for implementing Software I₂C communication. These routines are hardware independent and can be used with any MCU. The Software I₂C library enables you to use MCU as Master in I₂C communication. Multi-master mode is not supported.

Note: This library implements time-based activities, so interrupts need to be disabled when using Software I₂C.

Note: All I₂C Library functions are blocking-call functions (they are waiting for I₂C clock line to become logical one).

Note: The pins used for I₂C communication should be connected to the pull-up resistors. Turning off the LEDs connected to these pins may also be required.

External dependencies of Soft_I2C Library

The following variables must be defined in all projects using Soft_I2C Library:	Description:	Example :
<code>var Soft_I2C_Scl: sbit; external;</code>	Soft I ₂ C Clock line.	<code>var Soft_I2C_Scl: sbit at P1.B3;</code>
<code>var Soft_I2C_Sda: sbit; external;</code>	Soft I ₂ C Data line.	<code>var Soft_I2C_Sda: sbit at P1.B4;</code>

Library Routines

- Soft_I2C_Init
- Soft_I2C_Start
- Soft_I2C_Read
- Soft_I2C_Write
- Soft_I2C_Stop

Soft_I2C_Init

Prototype	<code>procedure Soft_I2C_Init();</code>
Returns	Nothing.
Description	Configures the software I ₂ C module.
Requires	<code>Soft_I2C_Scl</code> and <code>Soft_I2C_Sda</code> variables must be defined before using this function.
Example	<pre>// soft_i2c pinout definition var Soft_I2C_Scl : sbit at P1.B3; Soft_I2C_Sda : sbit at P1.B4; ... Soft_I2C_Init();</pre>

Soft_I2C_Start

Prototype	<code>procedure Soft_I2C_Start();</code>
Returns	Nothing.
Description	Determines if the I ₂ C bus is free and issues START signal.
Requires	Software I ₂ C must be configured before using this function. See <code>Soft_I2C_Init</code> routine.
Example	<pre>// Issue START signal Soft_I2C_Start();</pre>

Soft_I2C_Read

Prototype	<code>function Soft_I2C_Read(ack: word): byte;</code>
Returns	One byte from the Slave.
Description	<p>Reads one byte from the slave.</p> <p>Parameters :</p> <p>- <code>ack</code>: acknowledge signal parameter. If the <code>ack==0</code> not acknowledge signal will be sent after reading, otherwise the acknowledge signal will be sent.</p>
Requires	<p>Soft I²C must be configured before using this function. See <code>Soft_I²C_Init</code> routine.</p> <p>Also, START signal needs to be issued in order to use this function. See <code>Soft_I2C_Start</code> routine.</p>
Example	<pre>var take : word; ... // Read data and send the not_acknowledge signal take := Soft_I2C_Read(0);</pre>

Soft_I2C_Write

Prototype	<code>function Soft_I2C_Write(_Data: byte): byte;</code>
Returns	- 0 if there were no errors. - 1 if write collision was detected on the I ² C bus.
Description	Sends data byte via the I ² C bus. Parameters : - <code>_Data</code> : data to be sent
Requires	Soft I ² C must be configured before using this function. See <code>Soft_I2C_Init</code> routine. Also, START signal needs to be issued in order to use this function. See <code>Soft_I2C_Start</code> routine.
Example	<pre>var _data, error : byte; ... error := Soft_I2C_Write(data); error := Soft_I2C_Write(0xA3);</pre>

Soft_I2C_Stop

Prototype	<code>procedure Soft_I2C_Stop();</code>
Returns	Nothing.
Description	Issues STOP signal.
Requires	Soft I ² C must be configured before using this function. See <code>Soft_I2C_Init</code> routine.
Example	<pre>// Issue STOP signal Soft_I2C_Stop();</pre>

Library Example

The example demonstrates Software I₂C Library routines usage. The 8051 MCU is connected (SCL, SDA pins) to PCF8583 RTC (real-time clock). Program reads date and time are read from the RTC and prints it on LCD.

```
program RTC_Read;

var seconds, minutes, hours, day, month, year : byte;      // Global
date/time variables

// Software I2C connections
var Soft_I2C_Scl : sbit at P1.B3;
var Soft_I2C_Sda : sbit at P1.B4;
// End Software I2C connections

// LCD module connections
var LCD_RS : sbit at P2.B0;
var LCD_EN : sbit at P2.B1;

var LCD_D7 : sbit at P2.B5;
var LCD_D6 : sbit at P2.B4;
var LCD_D5 : sbit at P2.B3;
var LCD_D4 : sbit at P2.B2;
// End LCD module connections

//----- Reads time and date information from RTC
(PCF8583)
procedure Read_Time();
begin
    Soft_I2C_Start();           // Issue start signal
    Soft_I2C_Write(0xA0);      // Address PCF8583, see PCF8583
datasheet
    Soft_I2C_Write(2);         // Start from address 2
    Soft_I2C_Start();          // Issue repeated start signal
    Soft_I2C_Write(0xA1);      // Address PCF8583 for reading
R/W=1
    seconds := Soft_I2C_Read(1); // Read seconds byte
    minutes := Soft_I2C_Read(1); // Read minutes byte
    hours := Soft_I2C_Read(1);   // Read hours byte
    day := Soft_I2C_Read(1);     // Read year/day byte
    month := Soft_I2C_Read(0);   // Read weekday/month byte
    Soft_I2C_Stop();            // Issue stop signal
end;

//----- Formats date and time
procedure Transform_Time() ;
```

```

begin
    seconds := ((seconds and 0xF0) shr 4)*10 + (seconds and 0x0F);
// Transform seconds
    minutes := ((minutes and 0xF0) shr 4)*10 + (minutes and 0x0F);
// Transform months
    hours := ((hours and 0xF0) shr 4)*10 + (hours and 0x0F);
// Transform hours
    year := (day and 0xC0) shr 6; // Transform year
    day := ((day and 0x30) shr 4)*10 + (day and 0x0F);
// Transform day
    month := ((month and 0x10) shr 4)*10 + (month and 0x0F);
// Transform month
end;

//----- Output values to LCD
procedure Display_Time();
begin
    Lcd_Chr(1, 6, (day / 10) + 48); // Print tens digit of
day variable
    Lcd_Chr(1, 7, (day mod 10) + 48); // Print oness digit of
day variable
    Lcd_Chr(1, 9, (month / 10) + 48);
    Lcd_Chr(1,10, (month mod 10) + 48);
    Lcd_Chr(1,15, year + 56); // Print year vaiable +
8 (start from year 2008)

    Lcd_Chr(2, 6, (hours / 10) + 48);
    Lcd_Chr(2, 7, (hours mod 10) + 48);
    Lcd_Chr(2, 9, (minutes / 10) + 48);
    Lcd_Chr(2,10, (minutes mod 10) + 48);
    Lcd_Chr(2,12, (seconds / 10) + 48);
    Lcd_Chr(2,13, (seconds mod 10) + 48);
end;

//----- Performs project-wide init
procedure Init_Main();
begin
    Soft_I2C_Init(); // Initialize Soft I2C communication

    Lcd_Init(); // Initialize LCD
    Lcd_Cmd(LCD_CLEAR); // Clear LCD display
    Lcd_Cmd(LCD_CURSOR_OFF); // Turn cursor off

    LCD_Out(1,1,'Date:'); // Prepare and output static text on LCD
    LCD_Chr(1,8,':');
    LCD_Chr(1,11,':');
    LCD_Out(2,1,'Time:');
    LCD_Chr(2,8,':');
    LCD_Chr(2,11,':');
    LCD_Out(1,12,'200');
end;

```

```
//----- Main procedure
begin
  Init_Main();           // Perform initialization

  while TRUE do        // Endless loop
  begin
    Read_Time();       // Read time from RTC(PCF8583)
    Transform_Time();  // Format date and time
    Display_Time();    // Prepare and display on LCD
    Delay_ms(1000);    // Wait 1 second
  end;
end.
```

SOFTWARE SPI LIBRARY

The *mikroPascal for 8051* provides routines for implementing Software SPI communication. These routines are hardware independent and can be used with any MCU. The Software SPI Library provides easy communication with other devices via SPI: A/D converters, D/A converters, MAX7219, LTC1290, etc.

Library configuration:

- SPI to Master mode
- Clock value = 20 kHz.
- Data sampled at the middle of interval.
- Clock idle state low.
- Data sampled at the middle of interval.
- Data transmitted at low to high edge.

Note: The Software SPI library implements time-based activities, so interrupts need to be disabled when using it.

External dependencies of Software SPI Library

The following variables must be defined in all projects using Software SPI Library:	Description:	Example :
<code>var SoftSpi_SDI: sbit; external;</code>	Data In line.	<code>var SoftSpi_SDI: sbit at P0.B4;</code>
<code>var SoftSpi_SDO: sbit; external;</code>	Data Out line.	<code>var SoftSpi_SDO: sbit at P0.B5;</code>
<code>var SoftSpi_CLK: sbit; external;</code>	Clock line.	<code>var SoftSpi_CLK: sbit at P0.B3;</code>

Library Routines

- Soft_Spi_Init
- Soft_Spi_Read
- Soft_Spi_Write

Soft_Spi_Init

Prototype	<code>procedure Soft_SPI_Init();</code>
Returns	Nothing.
Description	Configures and initializes the software SPI module.
Requires	<code>SoftSpi_CLK</code> , <code>SoftSpi_SDI</code> and <code>SoftSpi_SDO</code> variables must be defined before using this function.
Example	<pre>// soft_spi pinout definition var SoftSpi_SDI : sbit at P0.B4; SoftSpi_SDO : sbit at P0.B5; SoftSpi_CLK : sbit at P0.B3; ... Soft_SPI_Init(); // Init Soft_SPI</pre>

Soft_Spi_Read

Prototype	<code>function Soft_Spi_Read(sdata: byte): byte;</code>
Returns	Byte received via the SPI bus.
Description	<p>This routine performs 3 operations simultaneously. It provides clock for the Software SPI bus, reads a byte and sends a byte.</p> <p>Parameters :</p> <p>- <code>sdata</code>: data to be sent.</p>
Requires	Soft SPI must be initialized before using this function. See <code>Soft_Spi_Init</code> routine.
Example	<pre>var data_read : byte; data_send : byte; ... // Read a byte and assign it to data_read variable // (data_send byte will be sent via SPI during the Read operation) data_read := Soft_Spi_Read(data_send);</pre>

Soft_Spi_Write

Prototype	<code>procedure Soft_Spi_Write(sdata: byte);</code>
Returns	Nothing.
Description	This routine sends one byte via the Software SPI bus. Parameters : - <code>sdata</code> : data to be sent.
Requires	Soft SPI must be initialized before using this function. See <code>Soft_Spi_Init</code> routine.
Example	<code>// Write a byte to the Soft SPI bus Soft_Spi_Write(0xAA);</code>

Library Example

This code demonstrates using library routines for Soft_SPI communication. Also, this example demonstrates working with Microchip's MCP4921 12-bit D/A converter.

```

program Soft_SPI;

// DAC module connections
var Chip_Select : sbit at P3.B4;
    SoftSpi_CLK : sbit at P1.B7;
    SoftSpi_SDI : sbit at P1.B6;
    SoftSpi_SDO : sbit at P1.B5;
// End DAC module connections

var value : word;

procedure InitMain();
begin
    P0 := 255; // Set PORT0 as input
    Soft_SPI_Init(); // Initialize Soft_SPI
end;

// DAC increments (0..4095) --> output voltage (0..Vref)
procedure DAC_Output( valueDAC : word);
var temp : byte;
begin
    Chip_Select := 0; // Select DAC chip

```

```
// Send High Byte
temp := (valueDAC shr 8) and 0x0F; // Store valueDAC[ 11..8]
to temp[ 3..0]
temp := temp or 0x30; // Define DAC setting, see MCP4921 datasheet
Soft_SPI_Write(temp); // Send high byte via Soft SPI

// Send Low Byte
temp := valueDAC; // Store valueDAC[ 7..0] to temp[ 7..0]
Soft_SPI_Write(temp); // Send low byte via Soft SPI

Chip_Select := 1; // Deselect DAC chip
end;

begin

InitMain(); // Perform main initialization

value := 2048; // When program starts, DAC gives
// the output in the mid-range

while TRUE do // Endless loop
begin
if ((P0_0 = 0) and (value < 4095)) then // If P0.0 is
connected to GND
Inc(value) // increment value
else
begin
if (( P0_1 = 0 ) and (value > 0)) then // If P0.1 is
connected to GND
Dec(value); // decrement value
end;
DAC_Output(value); // Perform output
Delay_ms(10); // Slow down key repeat pace
end;
end.
```

SOFTWARE UART LIBRARY

The *mikroPascal for 8051* provides routines for implementing Software UART communication. These routines are hardware independent and can be used with any MCU. The Software UART Library provides easy communication with other devices via the RS232 protocol.

Note: The Software UART library implements time-based activities, so interrupts need to be disabled when using it.

External dependencies of Software UART Library

The following variables must be defined in all projects using Software UART Library:	Description:	Example :
<code>var Soft_Uart_RX: sbit; external;</code>	Receive line.	<code>var Soft_Uart_RX: sbit at P3.B0;</code>
<code>var Soft_Uart_TX: sbit; external;</code>	Transmit line.	<code>var Soft_Uart_TX: sbit at P3.B1;</code>

Library Routines

- Soft_Uart_Init
- Soft_Uart_Read
- Soft_Uart_Write

Soft_Uart_Init

Prototype	<code>function Soft_Uart_Init(baud_rate: dword; inverted: byte): word;</code>
Returns	Nothing.
Description	<p>Configures and initializes the software UART module.</p> <p>Parameters :</p> <ul style="list-style-type: none"> - <code>baud_rate</code>: baud rate to be set. Maximum baud rate depends on the MCU's clock and working conditions. - <code>inverted</code>: inverted output flag. When set to a non-zero value, inverted logic on output is used.
Requires	<p>Global variables:</p> <ul style="list-style-type: none"> - <code>Soft_Uart_RX</code> receiver pin - <code>Soft_Uart_TX</code> transmitter pin <p>must be defined before using this function.</p>
Example	<pre>// Initialize Software UART communication on pins Rx, Tx, at 9600 // bps Soft_Uart_Init(9600, 0);</pre>

Soft_Uart_Read

Prototype	<code>function Soft_Uart_Read(var error: byte): byte;</code>
Returns	Byte received via UART.
Description	<p>The function receives a byte via software UART. This is a blocking function call (waits for start bit).</p> <p>Parameters :</p> <ul style="list-style-type: none"> - <code>error</code>: Error flag. Error code is returned through this variable. Upon successful transfer this flag will be set to zero. A non zero value indicates communication error.
Requires	Software UART must be initialized before using this function. See the <code>Soft_Uart_Init</code> routine.
Example	<pre> var data : byte; error : byte; ... // wait until data is received repeat data := Soft_Uart_Read(error); until (error=0); // Now we can work with data: if (data) then begin ... end </pre>

Soft_Uart_Write

Prototype	<code>procedure Soft_Uart_Write(udata: byte);</code>
Returns	Nothing.
Description	<p>This routine sends one byte via the Software UART bus.</p> <p>Parameters :</p> <ul style="list-style-type: none"> - <code>udata</code>: data to be sent.
Requires	<p>Software UART must be initialized before using this function. See the <code>Soft_Uart_Init</code> routine.</p> <p>Be aware that during transmission, software UART is incapable of receiving data – data transfer protocol must be set in such a way to prevent loss of information.</p>
Example	<pre>var some_byte : byte; ... // Write a byte via Soft Uart some_byte := 0x0A; Soft_Uart_Write(some_byte);</pre>

Library Example

This example demonstrates simple data exchange via software UART. If MCU is connected to the PC, you can test the example from the *mikroPascal for 8051* USART Terminal Tool.

```
program Soft_UART;

// Soft UART connections
var Soft_Uart_RX : sbit at P3.B0;
var Soft_Uart_TX : sbit at P3.B1;
// End Soft UART connections

var i, error, byte_read : byte;           // Auxiliary variables

begin

    Soft_Uart_Init(4800, 0);               // Initialize Soft UART
at 4800 bps
    for i := 'z' downto i >= 'A' do      // Send bytes from 'z'
downto 'A'
        begin
            Soft_Uart_Write(i);
            Delay_ms(100);
        end;

        while TRUE do                    // Endless loop
        begin
            byte_read := Soft_Uart_Read ( error ); // Read byte, then
test error flag
            if (error <> 0) then           // If error was detected
                P0 := 0xAA                 // signal it on PORT0
            else
                Soft_Uart_Write(byte_read); // If error was not
detected, return byte read
            end;
        end.
end.
```

SOUND LIBRARY

The *mikroPascal for 8051* provides a Sound Library to supply users with routines necessary for sound signalization in their applications. Sound generation needs additional hardware, such as piezo-speaker (example of piezo-speaker interface is given on the schematic at the bottom of this page).

External dependencies of Sound Library

The following variables must be defined in all projects using Sound Library:	Description:	Example :
<code>var Sound_Play_Pin: sbit; external;</code>	Sound output pin.	<code>var Sound_Play_Pin: sbit at P0.B3;</code>

Library Routines

- Sound_Init
- Sound_Play

Sound_Init

Prototype	<code>procedure Sound_Init();</code>
Returns	Nothing.
Description	Configures the appropriate MCU pin for sound generation.
Requires	Sound_Play_Pin variable must be defined before using this function.
Example	<pre>// Initialize the pin P0.3 for playing sound var Sound_Play_Pin : sbit at P0.B3; ... Sound_Init();</pre>

Sound_Play

Prototype	<code>procedure Sound_Play(var freq_in_Hz: word; var duration_ms: word);</code>
Returns	Nothing.
Description	Generates the square wave signal on the appropriate pin. Parameters : - <code>freq_in_Hz</code> : signal frequency in Hertz (Hz) - <code>duration_ms</code> : signal duration in miliseconds (ms)
Requires	In order to hear the sound, you need a piezo speaker (or other hardware) on designated port. Also, you must call <code>Sound_Init</code> to prepare hardware for output before using this function.
Example	<pre>// Play sound of 1KHz in duration of 100ms Sound_Play(1000, 100);</pre>

Library Example

The example is a simple demonstration of how to use the Sound Library for playing tones on a piezo speaker.

```
program Sound;
// Sound connections
var Sound_Play_Pin : sbit at P0.B3;
// End Sound connections

procedure Tone1();
begin
    Sound_Play(500, 200);           // Frequency = 500Hz, Duration = 200ms
end;

procedure Tone2() ;
begin
    Sound_Play(555, 200);           // Frequency = 555Hz, Duration = 200ms
end;

procedure Tone3() ;
begin
    Sound_Play(625, 200);           // Frequency = 625Hz, Duration = 200ms
end;

procedure Melody() ;                // Plays the melody "Yellow house"
begin
```

```

    Tone1(); Tone2(); Tone3(); Tone3();
    Tone1(); Tone2(); Tone3(); Tone3();
    Tone1(); Tone2(); Tone3();
    Tone1(); Tone2(); Tone3(); Tone3();
    Tone1(); Tone2(); Tone3();
    Tone3(); Tone3(); Tone2(); Tone2(); Tone1();
end;

procedure ToneA() ;           // Tones used in Melody2 function
begin
    Sound_Play(1250, 20);
end;

procedure ToneC() ;
begin
    Sound_Play(1450, 20);
end;
procedure ToneE() ;
begin
    Sound_Play(1650, 80);
end;

procedure Melody2() ;           // Plays Melody2
var i : word;
begin
    while i <> 1 do
        begin
            Dec(i);
            ToneA();
            ToneC();
            ToneE();
        end;
    end;

begin
    P1 := 255;                   // Configure PORT1 as input
    Sound_Init();                // Initialize sound pin

    Sound_Play(2000, 1000); // Play starting sound, 2kHz, 1 second

    while TRUE do               // endless loop
        begin
            if (P1_7 = 0) then // If P1.7 is pressed play Tone1
                begin
                    Tone1();
                    while ( P1_7 = 0) do nop ; // Wait for button to
                    be released
                end;
        end;

```

```
        if ( P1_6 = 0 ) then          // If P1.6 is pressed play Tone2
        begin
            Tone2();
            while ( P1_6 = 0 ) do nop;      // Wait for button to
be released
        end;

        if ( P1_5 = 0 ) then          // If P1.5 is pressed play Tone3
        begin
            Tone3();
            while ( P1_5 = 0 ) do nop ;    // Wait for button to
be released
        end;

        if ( P1_4 = 0 ) then          // If P1.4 is pressed play Melody2
        begin
            Melody2();
            while ( P1_4 = 0 ) do nop;    // Wait for button to
be released
        end;

        if ( P1_3 = 0 ) then          // If P1.3 is pressed play Melody
        begin
            Melody();
            while ( P1_3 = 0 ) do nop;    // Wait for button to
be released
        end;
    end;
end.
```

HW Connection

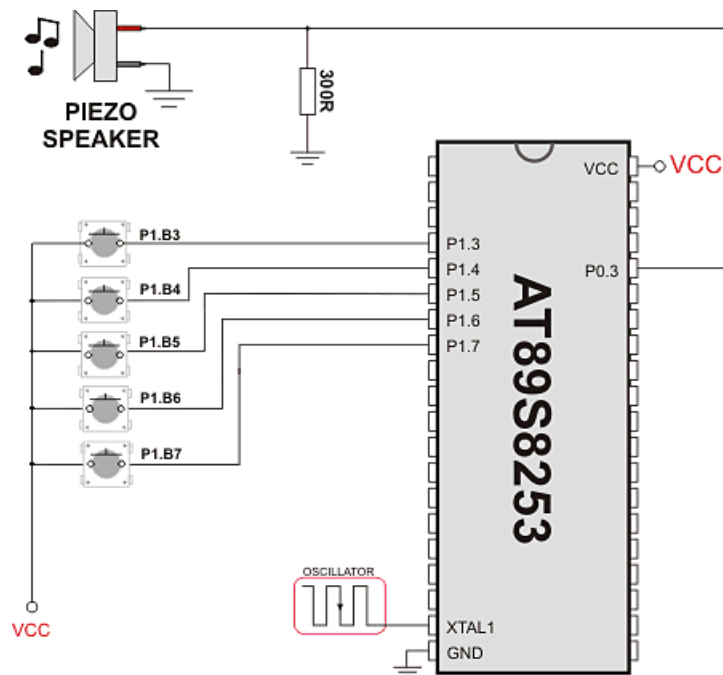

Example of Sound Library sonnection

SPI LIBRARY

mikroPascal for 8051 provides a library for comfortable with SPI work in Master mode. The 8051 MCU can easily communicate with other devices via SPI: A/D converters, D/A converters, MAX7219, LTC1290, etc.

Library Routines

- Spi_Init
- Spi_Init_Advanced
- Spi_Read
- Spi_Write

Spi_Init

Prototype	<code>procedure Spi_Init();</code>
Returns	Nothing.
Description	<p>This routine configures and enables SPI module with the following settings:</p> <ul style="list-style-type: none"> - master mode - clock idle low - 8 bit data transfer - most significant bit sent first - serial output data changes on idle to active transition of clock state - serial clock = fosc/128 (fosc/64 in x2 mode)
Requires	MCU must have SPI module.
Example	<code>// Initialize the SPI module with default settings Spi_Init();</code>

Spi_Init_Advanced

Prototype	<code>procedure Spi_Init_Advanced(adv_setting: byte)</code>																																																						
Returns	Nothing.																																																						
Description	This routine configures and enables the SPI module with the user defined settings. Parameters : - <code>adv_setting</code> : SPI module configuration flags. Predefined library constants (see the table below) can be ORed to form appropriate configuration value.																																																						
	<table border="1"> <thead> <tr> <th>Bit</th> <th>Mask</th> <th>Description</th> <th>Predefined library const</th> </tr> </thead> <tbody> <tr> <td colspan="4" style="text-align: center;">Master/slave [4] and clock rate select [1:0] bits</td> </tr> <tr> <td rowspan="4" style="text-align: center; vertical-align: middle;">4, 1, 0</td> <td>0x10</td> <td>Sck = Fosc/4 (Fosc/2 in x2 mode), Master mode</td> <td>MASTER_OSC_DIV4</td> </tr> <tr> <td>0x11</td> <td>Sck = Fosc/16 (f/8 in x2 mode), Master mode</td> <td>MASTER_OSC_DIV16</td> </tr> <tr> <td>0x12</td> <td>Sck = Fosc/64 (f/32 in x2 mode), Master mode</td> <td>MASTER_OSC_DIV64</td> </tr> <tr> <td>0x13</td> <td>Sck = Fosc/128 (f/64 in x2 mode), Master mode</td> <td>MASTER_OSC_DIV128</td> </tr> <tr> <td colspan="4" style="text-align: center;">SPI clock phase</td> </tr> <tr> <td rowspan="2" style="text-align: center; vertical-align: middle;">2</td> <td>0x00</td> <td>Data changes on idle to active transition of the clock</td> <td>IDLE_2_ACTIVE</td> </tr> <tr> <td>0x04</td> <td>Data changes on active to idle transition of the clock</td> <td>ACTIVE_2_IDLE</td> </tr> <tr> <td colspan="4" style="text-align: center;">SPI clock polarity</td> </tr> <tr> <td rowspan="2" style="text-align: center; vertical-align: middle;">3</td> <td>0x00</td> <td>Clock idle level is low</td> <td>CLK_IDLE_LOW</td> </tr> <tr> <td>0x08</td> <td>Clock idle level is high</td> <td>CLK_IDLE_HIGH</td> </tr> <tr> <td colspan="4" style="text-align: center;">Data order</td> </tr> <tr> <td rowspan="2" style="text-align: center; vertical-align: middle;">5</td> <td>0x00</td> <td>Most significant bit sent first</td> <td>DATA_ORDER_MSB</td> </tr> <tr> <td>0x20</td> <td>Least significant bit sent first</td> <td>DATA_ORDER_LSB</td> </tr> </tbody> </table>	Bit	Mask	Description	Predefined library const	Master/slave [4] and clock rate select [1:0] bits				4, 1, 0	0x10	Sck = Fosc/4 (Fosc/2 in x2 mode), Master mode	MASTER_OSC_DIV4	0x11	Sck = Fosc/16 (f/8 in x2 mode), Master mode	MASTER_OSC_DIV16	0x12	Sck = Fosc/64 (f/32 in x2 mode), Master mode	MASTER_OSC_DIV64	0x13	Sck = Fosc/128 (f/64 in x2 mode), Master mode	MASTER_OSC_DIV128	SPI clock phase				2	0x00	Data changes on idle to active transition of the clock	IDLE_2_ACTIVE	0x04	Data changes on active to idle transition of the clock	ACTIVE_2_IDLE	SPI clock polarity				3	0x00	Clock idle level is low	CLK_IDLE_LOW	0x08	Clock idle level is high	CLK_IDLE_HIGH	Data order				5	0x00	Most significant bit sent first	DATA_ORDER_MSB	0x20	Least significant bit sent first	DATA_ORDER_LSB
	Bit	Mask	Description	Predefined library const																																																			
	Master/slave [4] and clock rate select [1:0] bits																																																						
	4, 1, 0	0x10	Sck = Fosc/4 (Fosc/2 in x2 mode), Master mode	MASTER_OSC_DIV4																																																			
		0x11	Sck = Fosc/16 (f/8 in x2 mode), Master mode	MASTER_OSC_DIV16																																																			
		0x12	Sck = Fosc/64 (f/32 in x2 mode), Master mode	MASTER_OSC_DIV64																																																			
		0x13	Sck = Fosc/128 (f/64 in x2 mode), Master mode	MASTER_OSC_DIV128																																																			
	SPI clock phase																																																						
	2	0x00	Data changes on idle to active transition of the clock	IDLE_2_ACTIVE																																																			
0x04		Data changes on active to idle transition of the clock	ACTIVE_2_IDLE																																																				
SPI clock polarity																																																							
3	0x00	Clock idle level is low	CLK_IDLE_LOW																																																				
	0x08	Clock idle level is high	CLK_IDLE_HIGH																																																				
Data order																																																							
5	0x00	Most significant bit sent first	DATA_ORDER_MSB																																																				
	0x20	Least significant bit sent first	DATA_ORDER_LSB																																																				
Requires	MCU must have SPI module.																																																						
Example	<pre>// Set SPI to the Master Mode, clock = Fosc/4 , clock IDLE state low and data transmitted at low to high clock edge: Spi_Init_Advanced(MASTER_OSC_DIV4 or DATA_ORDER_MSB or CLK_IDLE_LOW or IDLE_2_ACTIVE);</pre>																																																						

Spi_Read

Prototype	<code>function Spi_Read(buffer: byte): byte;</code>
Returns	Received data.
Description	<p>Reads one byte from the SPI bus.</p> <p>Parameters :</p> <ul style="list-style-type: none"> - <code>buffer</code>: dummy data for clock generation (see device Datasheet for SPI modules implementation details)
Requires	SPI module must be initialized before using this function. See <code>Spi_Init</code> and <code>Spi_Init_Advanced</code> routines.
Example	<pre>// read a byte from the SPI bus var take, dummy1 : byte ; ... take := Spi_Read(dummy1);</pre>

Spi_Write

Prototype	<code>procedure Spi_Write(wrdata: byte);</code>
Returns	Nothing.
Description	<p>Writes byte via the SPI bus.</p> <p>Parameters :</p> <ul style="list-style-type: none"> - <code>wrdata</code>: data to be sent
Requires	SPI module must be initialized before using this function. See <code>Spi_Init</code> and <code>Spi_Init_Advanced</code> routines.
Example	<pre>// write a byte to the SPI bus var buffer : byte; ... Spi_Write(buffer);</pre>

Library Example

The code demonstrates how to use SPI library functions for communication between SPI module of the MCU and MAX7219 chip. MAX7219 controls eight 7 segment displays.

```
program SPI;

// Serial 7-seg Display connections
var CHIP_SEL : sbit at P1.B0; // Chip Select pin definition
// End Serial 7-seg Display connections

procedure Select_max() ; // Function for selecting MAX7219
begin
    CHIP_SEL := 0;
    Delay_us(1);
end;

procedure Deselect_max() ; // Function for deselecting MAX7219
begin
    Delay_us(1);
    CHIP_SEL := 1;
end;

procedure Max7219_init() ; // Initializing MAX7219
begin
    Select_max();
    Spi_Write(0x09); // BCD mode for digit decoding
    Spi_Write(0xFF);
    Deselect_max();

    Select_max();
    Spi_Write(0x0A);
    Spi_Write(0x0F); // Segment luminosity intensity
    Deselect_max();

    Select_max();
    Spi_Write(0x0B);
    Spi_Write(0x07); // Display refresh
    Deselect_max();

    Select_max();
    Spi_Write(0x0C);
    Spi_Write(0x01); // Turn on the display
    Deselect_max();

    Select_max();
    Spi_Write(0x00);
    Spi_Write(0xFF); // No test
    Deselect_max();
end;
```

```

var digit_position, digit_value : byte;

begin
    Spi_Init(); // Initialize SPI module, standard configuration
                // Instead of SPI_init, you can use SPI_init_Advanced
as shown below
                // Spi_Init_Advanced(MASTER_OSC_DIV4 or
DATA_ORDER_MSB or CLK_IDLE_LOW or IDLE_2_ACTIVE);

    Max7219_init(); // Initialize max7219

    while TRUE do
    begin
        for digit_value := 0 to 9 do // Endless loop
        begin
            for digit_position := 8 downto 1 do
            begin
                Select_max(); // Select max7219
                Spi_Write(digit_position); // Send digit position
                Spi_Write(digit_value); // Send digit value
                Deselect_max(); // Deselect max7219
                Delay_ms(300);
            end;
        end;
    end.

```

HW Connection

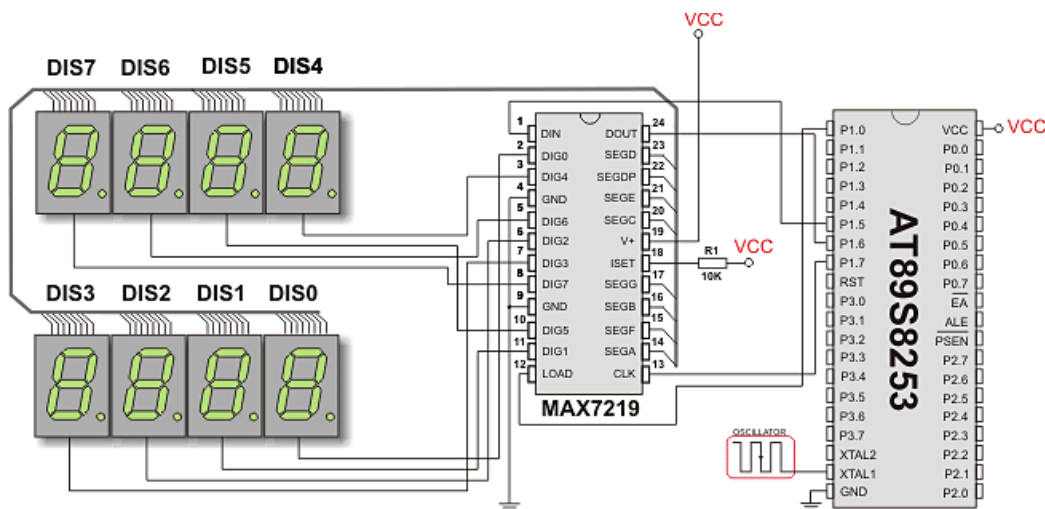

SPI HW connection

SPI ETHERNET LIBRARY

The [ENC28J60](#) is a stand-alone Ethernet controller with an industry standard Serial Peripheral Interface (SPI™). It is designed to serve as an Ethernet network interface for any controller equipped with SPI.

The [ENC28J60](#) meets all of the IEEE 802.3 specifications. It incorporates a number of packet filtering schemes to limit incoming packets. It also provides an internal DMA module for fast data throughput and hardware assisted IP checksum calculations. Communication with the host controller is implemented via two interrupt pins and the SPI, with data rates of up to 10 Mb/s. Two dedicated pins are used for LED link and network activity indication.

This library is designed to simplify handling of the underlying hardware (ENC28J60). It works with any 8051 MCU with integrated SPI and more than 4 Kb ROM memory.

SPI Ethernet library supports:

- IPv4 protocol.
- ARP requests.
- ICMP echo requests.
- UDP requests.
- TCP requests (no stack, no packet reconstruction).
- packet fragmentation is **NOT** supported.

Note: The appropriate hardware SPI module must be initialized before using any of the SPI Ethernet library routines. Refer to Spi Library.

The following variables must be defined in all projects using SPI Ethernet Library:	Description:	Example :
<code>var Spi_Ethernet_CS : sbit; external; sfr;</code>	ENC28J60 chip select pin.	<code>var Spi_Ethernet_CS : sbit at P1.B1; sfr;</code>
<code>var Spi_Ethernet_RST : sbit; external; sfr;</code>	ENC28J60 reset pin.	<code>var Spi_Ethernet_RST : sbit at P1.B0; sfr;</code>

The following routines must be defined in all project using SPI Ethernet Library:	Description:	Example :
<pre>function Spi_Ethernet_UserTCP (remoteHost : ^byte, remotePort : word, localPort : word, reqLength : word): word;</pre>	TCP request handler.	Refer to the library example at the bottom of this page for code implementation.
<pre>function Spi_Ethernet_UserUDP (remoteHost : ^byte, remotePort : word, destPort : word, reqLength : word): word;</pre>	UDP request handler.	Refer to the library example at the bottom of this page for code implementation.

Library Routines

- Spi_Ethernet_Init
- Spi_Ethernet_Enable
- Spi_Ethernet_Disable
- Spi_Ethernet_doPacket
- Spi_Ethernet_putByte
- Spi_Ethernet_putBytes
- Spi_Ethernet_putString
- Spi_Ethernet_putConstString
- Spi_Ethernet_putConstBytes
- Spi_Ethernet_getByte
- Spi_Ethernet_getBytes
- Spi_Ethernet_UserTCP
- Spi_Ethernet_UserUDP

Spi_Ethernet_Init

Prototype	<code>procedure Spi_Ethernet_Init(mac: ^byte; ip: ^byte; fullDuplex: byte);</code>
Returns	Nothing.
Description	<p>This is MAC module routine. It initializes <code>ENC28J60</code> controller. This function is internally split into 2 parts to help linker when coming short of memory.</p> <p><code>ENC28J60</code> controller settings (parameters not mentioned here are set to default):</p> <ul style="list-style-type: none"> - receive buffer start address : <code>0x0000</code>. - receive buffer end address : <code>0x19AD</code>. - transmit buffer start address: <code>0x19AE</code>. - transmit buffer end address : <code>0x1FFF</code>. - RAM buffer read/write pointers in auto-increment mode. - receive filters set to default: CRC + MAC Unicast + MAC Broadcast in OR mode. - flow control with TX and RX pause frames in full duplex mode. - frames are padded to <code>60</code> bytes + CRC. - maximum packet size is set to <code>1518</code>. - Back-to-Back Inter-Packet Gap: <code>0x15</code> in full duplex mode; <code>0x12</code> in half duplex mode. - Non-Back-to-Back Inter-Packet Gap: <code>0x0012</code> in full duplex mode; <code>0x0C12</code> in half duplex mode. - Collision window is set to <code>63</code> in half duplex mode to accomodate some <code>ENC28J60</code> revisions silicon bugs. - CLKOUT output is disabled to reduce EMI generation. - half duplex loopback disabled. - LED configuration: default (LEDA-link status, LEDB-link activity). <p>Parameters:</p> <ul style="list-style-type: none"> - <code>mac</code>: RAM buffer containing valid MAC address. - <code>ip</code>: RAM buffer containing valid IP address. - <code>fullDuplex</code>: ethernet duplex mode switch. Valid values: <code>0</code> (half duplex mode) and <code>1</code> (full duplex mode).
Requires	The appropriate hardware SPI module must be previously initialized.

Example

```
const Spi_Ethernet_HALFDUPLEX = 0;
const Spi_Ethernet_FULLDUPLEX = 1;

var
  myMacAddr : array[ 6] of byte; // my MAC address
  myIpAddr  : array[ 4] of byte; // my IP addr
  ...
  myMacAddr[ 0] := 0x00;
  myMacAddr[ 1] := 0x14;
  myMacAddr[ 2] := 0xA5;
  myMacAddr[ 3] := 0x76;
  myMacAddr[ 4] := 0x19;
  myMacAddr[ 5] := 0x3F;

  myIpAddr[ 0] := 192;
  myIpAddr[ 1] := 168;
  myIpAddr[ 2] := 1;
  myIpAddr[ 3] := 60;

  Spi_Init();
  Spi_Ethernet_Init(PORTC, 0, PORTC, 1, myMacAddr, myIpAddr,
Spi_Ethernet_FULLDUPLEX);
```

Spi_Ethernet_Enable

Prototype	<code>procedure Spi_Ethernet_Enable(enFlt: byte);</code>		
Returns	Nothing.		
Description	<p>This is MAC module routine. This routine enables appropriate network traffic on the <code>ENC28J60</code> module by the means of it's receive filters (unicast, multicast, broadcast, crc). Specific type of network traffic will be enabled if a corresponding bit of this routine's input parameter is set. Therefore, more than one type of network traffic can be enabled at the same time. For this purpose, predefined library constants (see the table below) can be ORed to form appropriate input value.</p> <p>Parameters:</p> <p>- <code>enFlt</code>: network traffic/receive filter flags. Each bit corresponds to the appropriate network traffic/receive filter:</p>		
	Bit	Mask	Description
	0	0x01	MAC Broadcast traffic/receive filter flag. When set, MAC broadcast traffic will be enabled.
	1	0x02	MAC Multicast traffic/receive filter flag. When set, MAC multicast traffic will be enabled.
	2	0x04	not used
	3	0x08	not used
	4	0x10	not used
	5	0x20	CRC check flag. When set, packets with invalid CRC field will be discarded.
	6	0x40	not used
	7	0x80	MAC Unicast traffic/receive filter flag. When set, MAC unicast traffic will be enabled.
		Predefined library const	
		<code>Spi_Ethernet_BROADCAST</code>	
		<code>Spi_Ethernet_MULTICAST</code>	
		<code>none</code>	
		<code>none</code>	
		<code>none</code>	
		<code>Spi_Ethernet_CRC</code>	
		<code>none</code>	
		<code>Spi_Ethernet_UNICAST</code>	
	<p>Note: Advance filtering available in the <code>ENC28J60</code> module such as <code>Pattern Match</code>, <code>Magic Packet</code> and <code>Hash Table</code> can not be enabled by this routine. Additionally, all filters, except CRC, enabled with this routine will work in OR mode, which means that packet will be received if any of the enabled filters accepts it.</p>		

Description	Note: This routine will change receive filter configuration on-the-fly. It will not, in any way, mess with enabling/disabling receive/transmit logic or any other part of the ENC28J60 module. The ENC28J60 module should be properly configured by the means of Spi_Ethernet_Init routine.
Requires	Ethernet module has to be initialized. See Spi_Ethernet_Init.
Example	<pre>Spi_Ethernet_Enable(Spi_Ethernet_CRC or Spi_Ethernet_UNICAST); // enable CRC checking and Unicast traffic</pre>

Spi_Ethernet_Disable

Prototype	<code>procedure Spi_Ethernet_Disable(disFlt: byte);</code>			
Returns	Nothing.			
Description	<p>This is MAC module routine. This routine disables appropriate network traffic on the ENC28J60 module by the means of it's receive filters (unicast, multicast, broadcast, crc). Specific type of network traffic will be disabled if a corresponding bit of this routine's input parameter is set. Therefore, more than one type of network traffic can be disabled at the same time. For this purpose, predefined library constants (see the table below) can be ORed to form appropriate input value.</p> <p>Parameters:</p> <ul style="list-style-type: none"> - <code>disFlt</code>: network traffic/receive filter flags. Each bit corresponds to the appropriate network traffic/receive filter: 			
	Bit	Mask	Description	
	Predefined library const			
	0	0x01	MAC Broadcast traffic/receive filter flag. When set, MAC broadcast traffic will be disabled.	<code>Spi_Ethernet_BROADCAST</code>
	1	0x02	MAC Multicast traffic/receive filter flag. When set, MAC multicast traffic will be disabled.	<code>Spi_Ethernet_MULTICAST</code>
	2	0x04	not used	none
	3	0x08	not used	none
	4	0x10	not used	none
	5	0x20	CRC check flag. When set, CRC check will be disabled and packets with invalid CRC field will be accepted.	<code>Spi_Ethernet_CRC</code>
	6	0x40	not used	none
7	0x80	MAC Unicast traffic/receive filter flag. When set, MAC unicast traffic will be disabled.	<code>Spi_Ethernet_UNICAST</code>	

Description	<p>Note: Advance filtering available in the <code>ENC28J60</code> module such as <code>Pattern Match</code>, <code>Magic Packet</code> and <code>Hash Table</code> can not be disabled by this routine.</p> <p>Note: This routine will change receive filter configuration on-the-fly. It will not, in any way, mess with enabling/disabling receive/transmit logic or any other part of the <code>ENC28J60</code> module. The <code>ENC28J60</code> module should be properly configured by the means of <code>Spi_Ethernet_Init</code> routine.</p>
Requires	Ethernet module has to be initialized. See <code>Spi_Ethernet_Init</code> .
Example	<pre>Spi_Ethernet_Disable(Spi_Ethernet_CRC or Spi_Ethernet_UNICAST); // disable CRC checking and Unicast traffic</pre>

`Spi_Ethernet_doPacket`

Prototype	<code>function Spi_Ethernet_doPacket(): byte;</code>
Returns	<ul style="list-style-type: none"> - 0 - upon successful packet processing (zero packets received or received packet processed successfully). - 1 - upon reception error or receive buffer corruption. <code>ENC28J60</code> controller needs to be restarted. - 2 - received packet was not sent to us (not our IP, nor IP broadcast address). - 3 - received IP packet was not IPv4. - 4 - received packet was of type unknown to the library.
Description	<p>This is MAC module routine. It processes next received packet if such exists. Packets are processed in the following manner:</p> <ul style="list-style-type: none"> - ARP & ICMP requests are replied automatically. - upon TCP request the <code>Spi_Ethernet_UserTCP</code> function is called for further processing. - upon UDP request the <code>Spi_Ethernet_UserUDP</code> function is called for further processing. <p>Note: <code>Spi_Ethernet_doPacket</code> must be called as often as possible in user's code.</p>
Requires	Ethernet module has to be initialized. See <code>Spi_Ethernet_Init</code> .
Example	<pre>while TRUE do begin Spi_Ethernet_doPacket(); // process received packets end</pre>

Spi_Ethernet_putByte

Prototype	<code>procedure Spi_Ethernet_putByte(v: byte);</code>
Returns	Nothing.
Description	This is MAC module routine. It stores one byte to address pointed by the current <code>ENC28J60</code> write pointer (<code>EWRPT</code>). Parameters: - <code>v</code> : value to store
Requires	Ethernet module has to be initialized. See <code>Spi_Ethernet_Init</code> .
Example	<pre>var data as byte; ... Spi_Ethernet_putByte(data); // put an byte into ENC28J60 buffer</pre>

Spi_Ethernet_putBytes

Prototype	<code>procedure Spi_Ethernet_putBytes(ptr : ^byte; n : byte);</code>
Returns	Nothing.
Description	This is MAC module routine. It stores requested number of bytes into <code>ENC28J60</code> RAM starting from current <code>ENC28J60</code> write pointer (<code>EWRPT</code>) location. Parameters: - <code>ptr</code> : RAM buffer containing bytes to be written into <code>ENC28J60</code> RAM. - <code>n</code> : number of bytes to be written.
Requires	Ethernet module has to be initialized. See <code>Spi_Ethernet_Init</code> .
Example	<pre>var buffer : array[17] of byte; ... buffer := 'mikroElektronika'; ... Spi_Ethernet_putBytes(buffer, 16); // put an RAM array into ENC28J60 buffer</pre>

Spi_Ethernet_putConstBytes

Prototype	<code>procedure Spi_Ethernet_putConstBytes(const ptr : ^byte; n : byte);</code>
Returns	Nothing.
Description	<p>This is MAC module routine. It stores requested number of const bytes into ENC28J60 RAM starting from current ENC28J60 write pointer (<i>EW RPT</i>) location.</p> <p>Parameters:</p> <ul style="list-style-type: none"> - <i>ptr</i>: const buffer containing bytes to be written into ENC28J60 RAM. - <i>n</i>: number of bytes to be written.
Requires	Ethernet module has to be initialized. See Spi_Ethernet_Init.
Example	<pre>const buffer : array[17] of byte; ... buffer := 'mikroElektronika'; ... Spi_Ethernet_putConstBytes(buffer, 16); // put a const array into ENC28J60 buffer</pre>

Spi_Ethernet_putString

Prototype	<code>function Spi_Ethernet_putString(^ptr : byte) : word;</code>
Returns	Number of bytes written into ENC28J60 RAM.
Description	<p>This is MAC module routine. It stores whole string (excluding null termination) into ENC28J60 RAM starting from current ENC28J60 write pointer (<i>EW RPT</i>) location.</p> <p>Parameters:</p> <ul style="list-style-type: none"> - <i>ptr</i>: string to be written into ENC28J60 RAM.
Requires	Ethernet module has to be initialized. See Spi_Ethernet_Init.
Example	<pre>var buffer : string[16]; ... buffer := 'mikroElektronika'; ... Spi_Ethernet_putString(buffer); // put a RAM string into ENC28J60 buffer</pre>

Spi_Ethernet_putConstString

Prototype	<code>function Spi_Ethernet_putConstString(const ptr : ^byte): word;</code>
Returns	Number of bytes written into ENC28J60 RAM.
Description	This is MAC module routine. It stores whole const string (excluding null termination) into ENC28J60 RAM starting from current ENC28J60 write pointer (EWRPT) location. Parameters: - <code>ptr</code> : const string to be written into ENC28J60 RAM.
Requires	Ethernet module has to be initialized. See Spi_Ethernet_Init.
Example	<pre>const buffer : string[16]; ... buffer := 'mikroElektronika'; ... Spi_Ethernet_putConstString(buffer); // put a const string into ENC28J60 buffer</pre>

Spi_Ethernet_getByte

Prototype	<code>function Spi_Ethernet_getByte(): byte;</code>
Returns	Byte read from ENC28J60 RAM.
Description	This is MAC module routine. It fetches a byte from address pointed to by current ENC28J60 read pointer (ERDPT).
Requires	Ethernet module has to be initialized. See Spi_Ethernet_Init.
Example	<pre>var buffer : byte; ... buffer := Spi_Ethernet_getByte(); // read a byte from ENC28J60 buffer</pre>

Spi_Ethernet_getBytes

Prototype	<code>procedure Spi_Ethernet_getBytes(ptr : ^byte; addr : word; n : byte);</code>
Returns	Nothing.
Description	<p>This is MAC module routine. It fetches requested number of bytes from ENC28J60 RAM starting from given address. If value of 0xFFFF is passed as the address parameter, the reading will start from current ENC28J60 read pointer (ERDPT) location.</p> <p>Parameters:</p> <ul style="list-style-type: none"> - ptr: buffer for storing bytes read from ENC28J60 RAM. - addr: ENC28J60 RAM start address. Valid values: 0..8192. - n: number of bytes to be read.
Requires	Ethernet module has to be initialized. See Spi_Ethernet_Init.
Example	<pre>var buffer : array[16] of byte; ... Spi_Ethernet_getBytes(buffer, 0x100, 16); // read 16 bytes, starting from address 0x100</pre>

Spi_Ethernet_UserTCP

Prototype	<code>function Spi_Ethernet_UserTCP(remoteHost : ^byte; remotePort : word; localPort : word; reqLength : word) : word;</code>
Returns	<ul style="list-style-type: none"> - 0 - there should not be a reply to the request. - Length of TCP/HTTP reply data field - otherwise.
Description	<p>This is TCP module routine. It is internally called by the library. The user accesses to the TCP/HTTP request by using some of the Spi_Ethernet_get routines. The user puts data in the transmit buffer by using some of the Spi_Ethernet_put routines. The function must return the length in bytes of the TCP/HTTP reply, or 0 if there is nothing to transmit. If there is no need to reply to the TCP/HTTP requests, just define this function with <code>return(0)</code> as a single statement.</p> <p>Parameters:</p> <ul style="list-style-type: none"> - <code>remoteHost</code> : client's IP address. - <code>remotePort</code> : client's TCP port. - <code>localPort</code> : port to which the request is sent. - <code>reqLength</code> : TCP/HTTP request data field length. <p>Note: The function source code is provided with appropriate example projects. The code should be adjusted by the user to achieve desired reply.</p>
Requires	Ethernet module has to be initialized. See Spi_Ethernet_Init.
Example	This function is internally called by the library and should not be called by the user's code.

Spi_Ethernet_UserUDP

Prototype	<code>function Spi_Ethernet_UserUDP(remoteHost : ^byte; remotePort : word; destPort : word; reqLength : word) : word;</code>
Returns	- 0 - there should not be a reply to the request. - Length of UDP reply data field - otherwise.
Description	<p>This is UDP module routine. It is internally called by the library. The user accesses to the UDP request by using some of the Spi_Ethernet_get routines. The user puts data in the transmit buffer by using some of the Spi_Ethernet_put routines. The function must return the length in bytes of the UDP reply, or 0 if nothing to transmit. If you don't need to reply to the UDP requests, just define this function with a return(0) as single statement.</p> <p>Parameters:</p> <ul style="list-style-type: none"> - <code>remoteHost</code> : client's IP address. - <code>remotePort</code> : client's port. - <code>destPort</code> : port to which the request is sent. - <code>reqLength</code> : UDP request data field length. <p>Note: The function source code is provided with appropriate example projects. The code should be adjusted by the user to achieve desired reply.</p>
Requires	Ethernet module has to be initialized. See Spi_Ethernet_Init.
Example	This function is internally called by the library and should not be called by the user's code.

Library Example

This code shows how to use the 8051 mini Ethernet library :

- the board will reply to ARP & ICMP echo requests
- the board will reply to UDP requests on any port :

returns the request in upper char with a header made of remote host IP & port number

- the board will reply to HTTP requests on port 80, GET method with pathnames :

/ will return the HTML main page

/s will return board status as text string

/t0 ... /t7 will toggle P3.b0 to P3.b7 bit and return HTML main page

all other requests return also HTML main page.

```

// duplex config flags
#define Spi_Ethernet_HALFDUPLEX      0x00 // half duplex
#define Spi_Ethernet_FULLDUPLEX      0x01 // full duplex

// mE ethernet NIC pinout
sfr sbit Spi_Ethernet_RST at P1.B0;
sfr sbit Spi_Ethernet_CS  at P1.B1;
// end ethernet NIC definitions

/*****
 * ROM constant strings
 */
const code byte httpHeader[] = "HTTP/1.1 200 OK\nContent-type: " ;
// HTTP header
const code byte httpMimeTypeHTML[] = "text/html\n\n" ; //
HTML MIME type
const code byte httpMimeTypeScript[] = "text/plain\n\n" ; //
TEXT MIME type
idata byte httpMethod[] = "GET /";
/*
 * web page, splited into 2 parts :
 * when coming short of ROM, fragmented data is handled more effi-
 * ciently by linker
 *
 * this HTML page calls the boards to get its status, and builds
 * itself with javascript
 */
const code char *indexPage = // Change the IP
address of the page to be refreshed
" <meta http-equiv=\ "refresh\ "
content=\ "3;url=http://192.168.1.60\ ">\
<HTML><HEAD></HEAD><BODY>\
<h1>8051 + ENC28J60 Mini Web Server</h1>\
<a href= />Reload</a>\
<script src= /s></script>\
<table><tr><td><table border=1 style=\ "font-size:20px ;font-family:\
terminal ;\ ">\
<tr><th colspan=2>P0</th></tr>\
<script>\
var str,i;\
str=\ "\";\
for(i=0;i<8;i++)\
{ str+=\ "<tr><td bgcolor=pink>BUTTON #\ "+i+\ "</td>\ "; \
if(P0&(1<<i)){ str+=\ "<td bgcolor=red>ON\ "; } \
else { str+=\ "<td bgcolor=#cccccc>OFF\ "; } \
str+=\ "</td></tr>\ "; \
document.write(str) ; \
</script>\
" ;

```

```

const char    *indexPage2 = "</table></td><td>\
<table border=1 style=\"font-size:20px ;font-family: terminal ;\">\
<tr><th colspan=3>P3</th></tr>\
<script>\
var str,i;\
str=\"\";\
for(i=0;i<8;i++)\
{ str+=\"<tr><td bgcolor=yellow>LED #\"+i+\"</td>\";\
if(P3&(1<<i)){ str+=\"<td bgcolor=red>ON\";\
else { str+=\"<td bgcolor=#cccccc>OFF\";\
str+=\"</td><td><a href=/t\"+i+\">Toggle</a></td></tr>\";\
document.write(str) ;\
</script>\
</table></td></tr></table>\
This            is            HTTP            request
#<script>document.write(REQ)</script></BODY></HTML>\
\" ;

/*****
 * RAM variables
 */
idata byte    myMacAddr[ 6] = { 0x00, 0x14, 0xA5, 0x76, 0x19, 0x3f} ;
// my MAC address
idata byte    myIpAddr[ 4]  = { 192, 168, 1, 60} ;           //
my IP address
idata byte    getRequest[ 15] ;                          //
HTTP request buffer
idata byte    dyna[ 29] ;                                  //
buffer for dynamic response
idata    unsigned    long            httpCounter    =    0    ;
// counter of HTTP requests

/*****
 * functions
 */

/*
 * put the constant string pointed to by s to the ENC transmit buffer.
 */
/*unsigned int    putConstString(const code char *s)
{
    unsigned int ctr = 0 ;

    while(*s)
    {
        Spi_Ethernet_putByte(*s++) ;
        ctr++ ;
    }
    return(ctr) ;
}*/

```

```
/*
 * it will be much faster to use library Spi_Ethernet_putConstString
 routine
 * instead of putConstString routine above. However, the code will
 be a little
 * bit bigger. User should choose between size and speed and pick the
 implementation that
 * suites him best. If you choose to go with the putConstString def-
 inition above
 * the #define line below should be commented out.
 *
 */
#define putConstString Spi_Ethernet_putConstString

/*
 * put the string pointed to by s to the ENC transmit buffer
 */
/*unsigned int putString(char *s)
 {
     unsigned int ctr = 0 ;

     while(*s)
         {
             Spi_Ethernet_putByte(*s++) ;

             ctr++ ;
         }
     return(ctr) ;
 }*/

/*
 * it will be much faster to use library Spi_Ethernet_putString rou-
 tine
 * instead of putString routine above. However, the code will be a
 little
 * bit bigger. User should choose between size and speed and pick the
 implementation that
 * suites him best. If you choose to go with the putString defini-
 tion above
 * the #define line below should be commented out.
 *
 */
#define putString Spi_Ethernet_putString
```

```
/*
 * this function is called by the library
 * the user accesses to the HTTP request by successive calls to
Spi_Ethernet_getByte()
 * the user puts data in the transmit buffer by successive calls to
Spi_Ethernet_putByte()
 * the function must return the length in bytes of the HTTP reply,
or 0 if nothing to transmit
 *
 * if you don't need to reply to HTTP requests,
 * just define this function with a return(0) as single statement
 *
 */
unsigned int Spi_Ethernet_UserTCP(byte *remoteHost, unsigned int
remotePort, unsigned int localPort, unsigned int reqLength)
{
    idata unsigned int len; // my reply length

    if(localPort != 80) // I listen
only to web request on port 80
    {
        return(0) ;
    }

    // get 10 first bytes only of the request, the rest does not
matter here
    for(len = 0 ; len < 10 ; len++)
    {
        getRequest[ len] = Spi_Ethernet_getByte() ;
    }
    getRequest[ len] = 0 ;

    len = 0;

    if(memcmp(getRequest, httpMethod, 5)) // only GET
method is supported here
    {
        return(0) ;
    }

    httpCounter++ ; // one more request done

    if(getRequest[ 5] == 's') // if request
path name starts with s, store dynamic data in transmit buffer
    {
        // the text string replied by this request can be
interpreted as javascript statements
        // by browsers
    }
}
```

```

len = putConstString(httpHeader) ; // HTTP header
len += putConstString(httpMimeTypeScript) ; //
with text MIME type

// add P3 value (buttons) to reply
len += putConstString("var P3=") ;
WordToStr(P3, dyna) ;
len += putString(dyna) ;
len += putConstString(";") ;

// add P0 value (LEDs) to reply
len += putConstString("var P0=") ;
WordToStr(P0, dyna) ;
len += putString(dyna) ;
len += putConstString(";") ;

// add HTTP requests counter to reply
WordToStr(httpCounter, dyna) ;
len += putConstString("var REQ=") ;
len += putString(dyna) ;
len += putConstString(";") ;
}
else if(getRequest[ 5] == 't') // if request
path name starts with t, toggle P3 (LED) bit number that comes after
{
byte bitMask = 0 ; // for bit mask

if(isdigit(getRequest[ 6])) // if 0
<= bit number <= 9, bits 8 & 9 does not exist but does not matter
{
bitMask = getRequest[ 6] - '0' ; //
convert ASCII to integer
bitMask = 1 << bitMask ; //
create bit mask
P3 ^= bitMask ; //
toggle P3 with xor operator
}
}

if(len == 0) // what do to by default
{
len = putConstString(httpHeader) ; //
HTTP header
len += putConstString(httpMimeTypeHTML) ; //
with HTML MIME type
len += putConstString(indexPage) ; //
HTML page first part
len += putConstString(indexPage2) ; //
HTML page second part
}

```

```
        return(len) ; //
return to the library with the number of bytes to transmit
    }

/*
 * this function is called by the library
 * the user accesses to the UDP request by successive calls to
Spi_Ethernet_getByte()
 * the user puts data in the transmit buffer by successive calls to
Spi_Ethernet_putByte()
 * the function must return the length in bytes of the UDP reply, or
0 if nothing to transmit
 *
 * if you don't need to reply to UDP requests,
 * just define this function with a return(0) as single statement
 *
 */
unsigned int Spi_Ethernet_UserUDP(byte *remoteHost, unsigned int
remotePort, unsigned int destPort, unsigned int reqLength)
{
    idata unsigned int len ; // my reply length
    idata byte * ptr ; // pointer to the dynamic buffer

    // reply is made of the remote host IP address in human read-
able format
    ByteToStr(remoteHost[ 0], dyna) ; // first IP address byte
    dyna[ 3] = '.' ;
    ByteToStr(remoteHost[ 1], dyna + 4) ; // second
    dyna[ 7] = '.' ;
    ByteToStr(remoteHost[ 2], dyna + 8) ; // third
    dyna[ 11] = '.' ;
    ByteToStr(remoteHost[ 3], dyna + 12) ; // fourth

    dyna[ 15] = ':' ; // add separator

    // then remote host port number
    WordToStr(remotePort, dyna + 16) ;
    dyna[ 21] = '[' ;
    WordToStr(destPort, dyna + 22) ;
    dyna[ 27] = ']' ;
    dyna[ 28] = 0 ;

    // the total length of the request is the length of the
dynamic string plus the text of the request
    len = 28 + reqLength;

    // puts the dynamic string into the transmit buffer
    Spi_Ethernet_putBytes(dyna, 28) ;
}
```

```

// then puts the request string converted into upper char into the
transmit buffer
    while(reqLength--)
    {
        Spi_Ethernet_putByte(toupper(Spi_Ethernet_getByte()))
;
        }

    return(len) ; // back to the library with the
length of the UDP reply
    }

/*
 * main entry
 */
procedure main()
{
    /*
    * starts ENC28J60 with :
    * reset bit on P1_0
    * CS bit on P1_1
    * my MAC & IP address
    * full duplex
    */
    Spi_Init_Advanced(MASTER_OSC_DIV16 or CLK_IDLE_LOW or
IDLE_2_ACTIVE or DATA_ORDER_MSB);
    Spi_Ethernet_Init(myMacAddr, myIpAddr, Spi_Ethernet_FULLDU-
PLEX) ; // full duplex, CRC + MAC Unicast + MAC Broadcast filtering

    while(1) // do forever
    {
        /*
        * if necessary, test the return value to get error
code
        */
        Spi_Ethernet_doPacket() ; // process incoming
Ethernet packets

        /*
        * add your stuff here if needed
        * Spi_Ethernet_doPacket() must be called as often
as possible
        * otherwise packets could be lost
        */
    }
}

```

HW Connection

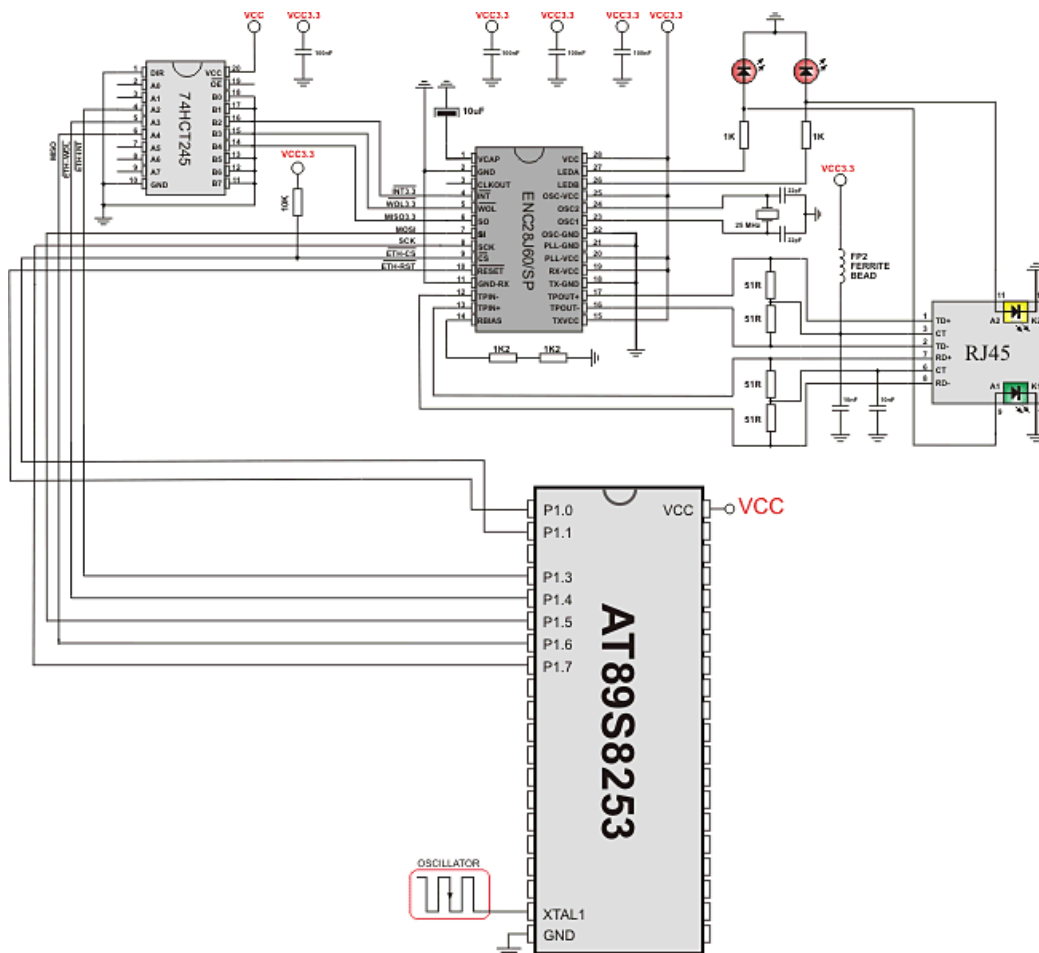

SPI GRAPHIC LCD LIBRARY

The *mikroPascal for 8051* provides a library for operating Graphic LCD 128x64 (with commonly used Samsung KS108/KS107 controller) via SPI interface.

For creating a custom set of GLCD images use GLCD Bitmap Editor Tool.

Note: The library uses the SPI module for communication. User must initialize SPI module before using the SPI Graphic LCD Library.

Note: This Library is designed to work with the mikroElektronika's Serial LCD/GLCD Adapter Board pinout, see schematic at the bottom of this page for details.

External dependencies of SPI Graphic LCD Library

The implementation of SPI Graphic LCD Library routines is based on Port Expander Library routines.

External dependencies are the same as Port Expander Library external dependencies.

Library Routines

Basic routines:

- Spi_Glcd_Init
- Spi_Glcd_Set_Side
- Spi_Glcd_Set_Page
- Spi_Glcd_Set_X
- Spi_Glcd_Read_Data
- Spi_Glcd_Write_Data

Advanced routines:

- Spi_Glcd_Fill
- Spi_Glcd_Dot
- Spi_Glcd_Line
- Spi_Glcd_V_Line
- Spi_Glcd_H_Line
- Spi_Glcd_Rectangle
- Spi_Glcd_Box
- Spi_Glcd_Circle
- Spi_Glcd_Set_Font
- Spi_Glcd_Write_Char
- Spi_Glcd_Write_Text
- Spi_Glcd_Image

Spi_Glcd_Init

Prototype	<code>procedure Spi_Glcd_Init(DeviceAddress : byte);</code>
Returns	Nothing.
Description	<p>Initializes the GLCD module via SPI interface.</p> <p>Parameters :</p> <ul style="list-style-type: none"> - <code>DeviceAddress</code>: spi expander hardware address, see schematic at the bottom of this page
Requires	<p><code>SPExpanderCS</code> and <code>SPExpanderRST</code> variables must be defined before using this function.</p> <p>The SPI module needs to be initialized. See <code>Spi_Init</code> and <code>Spi_Init_Advanced</code> routines.</p>
Example	<pre>// port expander pinout definition var SPExpanderRST : sbit at P1.B0; SPExpanderCS : sbit at P1.B1; ... Spi_Init_Advanced(MASTER_OSC_DIV4 or CLK_IDLE_LOW or IDLE_2_ACTIVE or DATA_ORDER_MSB); Spi_Glcd_Init(0);</pre>

Spi_Glcd_Set_Side

Prototype	<code>procedure SPI_Glcd_Set_Side(x_pos : byte);</code>
Returns	Nothing.
Description	<p>Selects GLCD side. Refer to the GLCD datasheet for detail explanation.</p> <p>Parameters :</p> <ul style="list-style-type: none"> - <code>x_pos</code>: position on x-axis. Valid values: 0..127 <p>The parameter <code>x_pos</code> specifies the GLCD side: values from 0 to 63 specify the left side, values from 64 to 127 specify the right side.</p> <p>Note: For side, x axis and page layout explanation see schematic at the bottom of this page.</p>
Requires	GLCD needs to be initialized for SPI communication, see <code>Spi_Glcd_Init</code> routines.
Example	<p>The following two lines are equivalent, and both of them select the left side of GLCD:</p> <pre>SPI_Glcd_Set_Side(0); SPI_Glcd_Set_Side(10);</pre>

Spi_Glcd_Set_Page

Prototype	<code>procedure Spi_Glcd_Set_Page(page : byte);</code>
Returns	Nothing.
Description	<p>Selects page of GLCD.</p> <p>Parameters :</p> <p>- <code>page</code>: page number. Valid values: 0..7</p> <p>Note: For side, x axis and page layout explanation see schematic at the bottom of this page.</p>
Requires	GLCD needs to be initialized for SPI communication, see <code>Spi_Glcd_Init</code> routines.
Example	<code>Spi_Glcd_Set_Page(5);</code>

Spi_Glcd_Set_X

Prototype	<code>procedure SPI_Glcd_Set_X(x_pos : byte);</code>
Returns	Nothing.
Description	<p>Sets x-axis position to <code>x_pos</code> dots from the left border of GLCD within the selected side.</p> <p>Parameters :</p> <p>- <code>x_pos</code>: position on x-axis. Valid values: 0..63</p> <p>Note: For side, x axis and page layout explanation see schematic at the bottom of this page.</p>
Requires	GLCD needs to be initialized for SPI communication, see <code>Spi_Glcd_Init</code> routines.
Example	<code>Spi_Glcd_Set_X(25);</code>

Spi_Glcd_Read_Data

Prototype	<code>function Spi_Glcd_Read_Data() : byte;</code>
Returns	One byte from GLCD memory.
Description	Reads data from the current location of GLCD memory and moves to the next location.
Requires	GLCD needs to be initialized for SPI communication, see Spi_Glcd_Init routines. GLCD side, x-axis position and page should be set first. See the functions Spi_Glcd_Set_Side, Spi_Glcd_Set_X, and Spi_Glcd_Set_Page.
Example	<pre>var data : byte; ... data := Spi_Glcd_Read_Data();</pre>

Spi_Glcd_Write_Data

Prototype	<code>procedure Spi_Glcd_Write_Data(Ddata : byte);</code>
Returns	Nothing.
Description	Writes one byte to the current location in GLCD memory and moves to the next location. Parameters : - <i>Ddata</i> : data to be written
Requires	GLCD needs to be initialized for SPI communication, see Spi_Glcd_Init routines. GLCD side, x-axis position and page should be set first. See the functions Spi_Glcd_Set_Side, Spi_Glcd_Set_X, and Spi_Glcd_Set_Page.
Example	<pre>var ddata : byte; ... Spi_Glcd_Write_Data(ddata);</pre>

Spi_Glcd_Fill

Prototype	<code>procedure Spi_Glcd_Fill(pattern: byte);</code>
Returns	Nothing.
Description	<p>Fills GLCD memory with byte pattern.</p> <p>Parameters :</p> <ul style="list-style-type: none"> - <code>pattern</code>: byte to fill GLCD memory with <p>To clear the GLCD screen, use <code>Spi_Glcd_Fill(0)</code>.</p> <p>To fill the screen completely, use <code>Spi_Glcd_Fill(0xFF)</code>.</p>
Requires	GLCD needs to be initialized for SPI communication, see <code>Spi_Glcd_Init</code> routines.
Example	<pre>// Clear screen Spi_Glcd_Fill(0);</pre>

Spi_Glcd_Dot

Prototype	<code>procedure Spi_Glcd_Dot(x_pos : byte; y_pos : byte; color : byte);</code>
Returns	Nothing.
Description	<p>Draws a dot on GLCD at coordinates (<code>x_pos</code>, <code>y_pos</code>).</p> <p>Parameters :</p> <ul style="list-style-type: none"> - <code>x_pos</code>: x position. Valid values: 0..127 - <code>y_pos</code>: y position. Valid values: 0..63 - <code>color</code>: color parameter. Valid values: 0..2 <p>The parameter <code>color</code> determines the dot state: 0 clears dot, 1 puts a dot, and 2 inverts dot state.</p> <p>Note: For x and y axis layout explanation see schematic at the bottom of this page.</p>
Requires	GLCD needs to be initialized for SPI communication, see <code>Spi_Glcd_Init</code> routines.
Example	<pre>// Invert the dot in the upper left corner Spi_Glcd_Dot(0, 0, 2);</pre>

Spi_Glcd_Line

Prototype	<code>procedure Spi_Glcd_Line(x_start : integer; y_start : integer; x_end : integer; y_end : integer; color : byte);</code>
Returns	Nothing.
Description	<p>Draws a line on GLCD.</p> <p>Parameters :</p> <ul style="list-style-type: none"> - <code>x_start</code>: x coordinate of the line start. Valid values: 0..127 - <code>y_start</code>: y coordinate of the line start. Valid values: 0..63 - <code>x_end</code>: x coordinate of the line end. Valid values: 0..127 - <code>y_end</code>: y coordinate of the line end. Valid values: 0..63 - <code>color</code>: color parameter. Valid values: 0..2 <p>Parameter <code>color</code> determines the line color: 0 white, 1 black, and 2 inverts each dot.</p>
Requires	GLCD needs to be initialized for SPI communication, see <code>Spi_Glcd_Init</code> routines.
Example	<pre>// Draw a line between dots (0,0) and (20,30) Spi_Glcd_Line(0, 0, 20, 30, 1);</pre>

Spi_Glcd_V_Line

Prototype	<code>procedure Spi_Glcd_V_Line(y_start: byte; y_end: byte; x_pos: byte; color: byte);</code>
Returns	Nothing.
Description	<p>Draws a vertical line on GLCD.</p> <p>Parameters :</p> <ul style="list-style-type: none"> - <code>y_start</code>: y coordinate of the line start. Valid values: 0..63 - <code>y_end</code>: y coordinate of the line end. Valid values: 0..63 - <code>x_pos</code>: x coordinate of vertical line. Valid values: 0..127 - <code>color</code>: color parameter. Valid values: 0..2 <p>Parameter <code>color</code> determines the line color: 0 white, 1 black, and 2 inverts each dot.</p>
Requires	GLCD needs to be initialized for SPI communication, see <code>Spi_Glcd_Init</code> routines.
Example	<pre>// Draw a vertical line between dots (10,5) and (10,25) Spi_Glcd_V_Line(5, 25, 10, 1);</pre>

Spi_Glcd_H_Line

Prototype	<code>procedure Spi_Glcd_V_Line(x_start : byte; x_end : byte; y_pos : byte; color : byte);</code>
Returns	Nothing.
Description	<p>Draws a horizontal line on GLCD.</p> <p>Parameters :</p> <ul style="list-style-type: none"> - <code>x_start</code>: x coordinate of the line start. Valid values: 0..127 - <code>x_end</code>: x coordinate of the line end. Valid values: 0..127 - <code>y_pos</code>: y coordinate of horizontal line. Valid values: 0..63 - <code>color</code>: color parameter. Valid values: 0..2 <p>The parameter <code>color</code> determines the line color: 0 white, 1 black, and 2 inverts each dot.</p>
Requires	GLCD needs to be initialized for SPI communication, see <code>Spi_Glcd_Init</code> routines.
Example	<code>// Draw a horizontal line between dots (10,20) and (50,20)</code> <code>Spi_Glcd_H_Line(10, 50, 20, 1);</code>

Spi_Glcd_Rectangle

Prototype	<code>procedure Spi_Glcd_Rectangle(x_upper_left : byte; y_upper_left : byte; x_bottom_right : byte; y_bottom_right : byte; color : byte);</code>
Returns	Nothing.
Description	<p>Draws a rectangle on GLCD.</p> <p>Parameters :</p> <ul style="list-style-type: none"> - <code>x_upper_left</code>: x coordinate of the upper left rectangle corner. Valid values: 0..127 - <code>y_upper_left</code>: y coordinate of the upper left rectangle corner. Valid values: 0..63 - <code>x_bottom_right</code>: x coordinate of the lower right rectangle corner. Valid values: 0..127 - <code>y_bottom_right</code>: y coordinate of the lower right rectangle corner. Valid values: 0..63 - <code>color</code>: color parameter. Valid values: 0..2 <p>The parameter <code>color</code> determines the color of the rectangle border: 0 white, 1 black, and 2 inverts each dot.</p>
Requires	GLCD needs to be initialized for SPI communication, see <code>Spi_Glcd_Init</code> routines.
Example	<code>// Draw a rectangle between dots (5,5) and (40,40)</code> <code>Spi_Glcd_Rectangle(5, 5, 40, 40, 1);</code>

Spi_Glcd_Box

Prototype	<code>procedure Spi_Glcd_Box(x_upper_left : byte; y_upper_left : byte; x_bottom_right : byte; y_bottom_right : byte; color : byte);</code>
Returns	Nothing.
Description	<p>Draws a box on GLCD.</p> <p>Parameters :</p> <ul style="list-style-type: none"> - <code>x_upper_left</code>: x coordinate of the upper left box corner. Valid values: 0..127 - <code>y_upper_left</code>: y coordinate of the upper left box corner. Valid values: 0..63 - <code>x_bottom_right</code>: x coordinate of the lower right box corner. Valid values: 0..127 - <code>y_bottom_right</code>: y coordinate of the lower right box corner. Valid values: 0..63 - <code>color</code>: color parameter. Valid values: 0..2 <p>The parameter <code>color</code> determines the color of the box fill: 0 white, 1 black, and 2 inverts each dot.</p>
Requires	GLCD needs to be initialized for SPI communication, see <code>Spi_Glcd_Init</code> routines.
Example	<pre>// Draw a box between dots (5,15) and (20,40) Spi_Glcd_Box(5, 15, 20, 40, 1);</pre>

Spi_Glcd_Circle

Prototype	<code>procedure Spi_Glcd_Circle(x_center : integer; y_center : integer; radius : integer; color : byte);</code>
Returns	Nothing.
Description	<p>Draws a circle on GLCD.</p> <p>Parameters :</p> <ul style="list-style-type: none"> - <code>x_center</code>: x coordinate of the circle center. Valid values: 0..127 - <code>y_center</code>: y coordinate of the circle center. Valid values: 0..63 - <code>radius</code>: radius size - <code>color</code>: color parameter. Valid values: 0..2 <p>The parameter <code>color</code> determines the color of the circle line: 0 white, 1 black, and 2 inverts each dot.</p>
Requires	GLCD needs to be initialized for SPI communication, see <code>Spi_Glcd_Init</code> routine.
Example	<pre>// Draw a circle with center in (50,50) and radius=10 Spi_Glcd_Circle(50, 50, 10, 1);</pre>

Spi_Glcd_Set_Font

Prototype	<code>procedure SPI_Glcd_Set_Font(const activeFont : ^byte; aFontWidth : byte; aFontHeight : byte; aFontOffs : word);</code>
Returns	Nothing.
Description	<p>Sets font that will be used with Spi_Glcd_Write_Char and Spi_Glcd_Write_Text routines.</p> <p>Parameters :</p> <ul style="list-style-type: none"> - <code>activeFont</code>: font to be set. Needs to be formatted as an array of char - <code>aFontWidth</code>: width of the font characters in dots. - <code>aFontHeight</code>: height of the font characters in dots. - <code>aFontOffs</code>: number that represents difference between the mikroPascal character set and regular ASCII set (eg. if 'A' is 65 in ASCII character, and 'A' is 45 in the mikroPascal character set, aFontOffs is 20). Demo fonts supplied with the library have an offset of 32, which means that they start with space. <p>The user can use fonts given in the file “__Lib_GLCD_fonts.mpas” file located in the Uses folder or create his own fonts.</p>
Requires	GLCD needs to be initialized for SPI communication, see Spi_Glcd_Init routines.
Example	<code>// Use the custom 5x7 font "myfont" which starts with space (32): Spi_Glcd_Set_Font(myfont, 5, 7, 32);</code>

Spi_Glcd_Write_Char

Prototype	<pre>procedure SPI_Glcd_Write_Char(chr1 : byte; x_pos : byte; page_num : byte; color : byte);</pre>
Returns	Nothing.
Description	<p>Prints character on GLCD.</p> <p>Parameters :</p> <ul style="list-style-type: none">- <code>chr1</code>: character to be written- <code>x_pos</code>: character starting position on x-axis. Valid values: 0..(127-FontWidth)- <code>page_num</code>: the number of the page on which character will be written. Valid values: 0..7- <code>color</code>: color parameter. Valid values: 0..2 <p>The parameter <code>color</code> determines the color of the character: 0 white, 1 black, and 2 inverts each dot.</p> <p>Note: For x axis and page layout explanation see schematic at the bottom of this page.</p>
Requires	<p>GLCD needs to be initialized for SPI communication, see <code>Spi_Glcd_Init</code> routines.</p> <p>Use the <code>Spi_Glcd_Set_Font</code> to specify the font for display; if no font is specified, then the default 5x8 font supplied with the library will be used.</p>
Example	<pre>// Write character 'C' on the position 10 inside the page 2: Spi_Glcd_Write_Char("C", 10, 2, 1);</pre>

Spi_Glcd_Write_Text

Prototype	<pre>procedure SPI_Glcd_Write_Text(var text : string[20] ; x_pos : byte; page_num : byte; color : byte);</pre>
Returns	Nothing.
Description	<p>Prints text on GLCD.</p> <p>Parameters :</p> <ul style="list-style-type: none"> - <code>text</code>: text to be written - <code>x_pos</code>: text starting position on x-axis. - <code>page_num</code>: the number of the page on which text will be written. Valid values: 0..7 - <code>color</code>: color parameter. Valid values: 0..2 <p>The parameter <code>color</code> determines the color of the text: 0 white, 1 black, and 2 inverts each dot.</p> <p>Note: For x axis and page layout explanation see schematic at the bottom of this page.</p>
Requires	<p>GLCD needs to be initialized for SPI communication, see <code>Spi_Glcd_Init</code> routines.</p> <p>Use the <code>Spi_Glcd_Set_Font</code> to specify the font for display; if no font is specified, then the default 5x8 font supplied with the library will be used.</p>
Example	<pre>// Write text "Hello world!" on the position 10 inside the page 2: Spi_Glcd_Write_Text("Hello world!", 10, 2, 1);</pre>

Spi_Glcd_Image

Prototype	<code>procedure Spi_Glcd_Image(const image : ^byte);</code>
Returns	Nothing.
Description	<p>Displays bitmap on GLCD.</p> <p>Parameters :</p> <ul style="list-style-type: none">- <code>image</code>: image to be displayed. Bitmap array can be located in both code and RAM memory (due to the <i>mikroPascal for 8051</i> pointer to const and pointer to RAM equivalency). <p>Use the mikroPascal's integrated GLCD Bitmap Editor (menu option Tools > GLCD Bitmap Editor) to convert image to a constant array suitable for displaying on GLCD.</p>
Requires	GLCD needs to be initialized for SPI communication, see <code>Spi_Glcd_Init</code> routines.
Example	<pre>// Draw image my_image on GLCD Spi_Glcd_Image(my_image);</pre>

Library Example

The example demonstrates how to communicate to KS0108 GLCD via the SPI module, using serial to parallel convertor MCP23S17.

```
program SerialGLCD;

uses bitmap;

// Port Expander module connections
var SPExpanderRST : sbit at P1.B0;
var SPExpanderCS  : sbit at P1.B1;
// End Port Expander module connections

var
  counter, counter2: byte;
  jj: word;
  someText: string[ 20] ;

procedure delay2S;
begin
  delay_ms(2000);
end;

begin
```

```

Spi_Init_Advanced(MASTER_OSC_DIV4 or CLK_IDLE_LOW or IDLE_2_ACTIVE
or DATA_ORDER_MSB);
Spi_Glcd_Init(0);           // Initialize GLCD via SPI
Spi_Glcd_Fill(0x00);       // Clear GLCD

while TRUE do
begin

Spi_Glcd_Image(@advanced8051_bmp);   // Draw image
Delay2S(); Delay2S();

Spi_Glcd_Fill(0x00);
Delay2s;
Spi_Glcd_Box(62,40,124,56,1);        // Draw box
Spi_Glcd_Rectangle(5,5,84,35,1);    // Draw rectangle
Spi_Glcd_Line(0, 63, 127, 0,1);     // Draw line

Delay2S();

counter := 5;           // Draw horizontal and vertical line
while counter < 60 do
begin
Delay_ms(250);
Spi_Glcd_V_Line(2, 54, counter, 1);
Spi_Glcd_H_Line(2, 120, counter, 1);
counter := counter + 5;
end;

Delay2S();

Spi_Glcd_Fill(0x00);

Spi_Glcd_Set_Font(@Character8x8, 8, 8, 32); // Choose font,
see ___Lib_GLCDFonts.c in Uses folder
Spi_Glcd_Write_Text('mikroE', 5, 7, 2);    // Write string

for counter2 := 1 to 10 do                // Draw circles
Spi_Glcd_Circle(63,32, 3*counter2, 1);
Delay2S();

Spi_Glcd_Box(12,20, 70,63, 2);           // Draw box
Delay2S();

Spi_Glcd_Set_Font(@FontSystem5x8, 5, 8, 32); // Change font
someText := 'BIG:LETTERS';
Spi_Glcd_Write_Text(someText, 5, 3, 2);   // Write string
Delay2S();

someText := 'SMALL:NOT:SMALLER';
Spi_Glcd_Write_Text(someText, 20,5, 1);   // Write string
Delay2S();

end;

end.

```

HW Connection

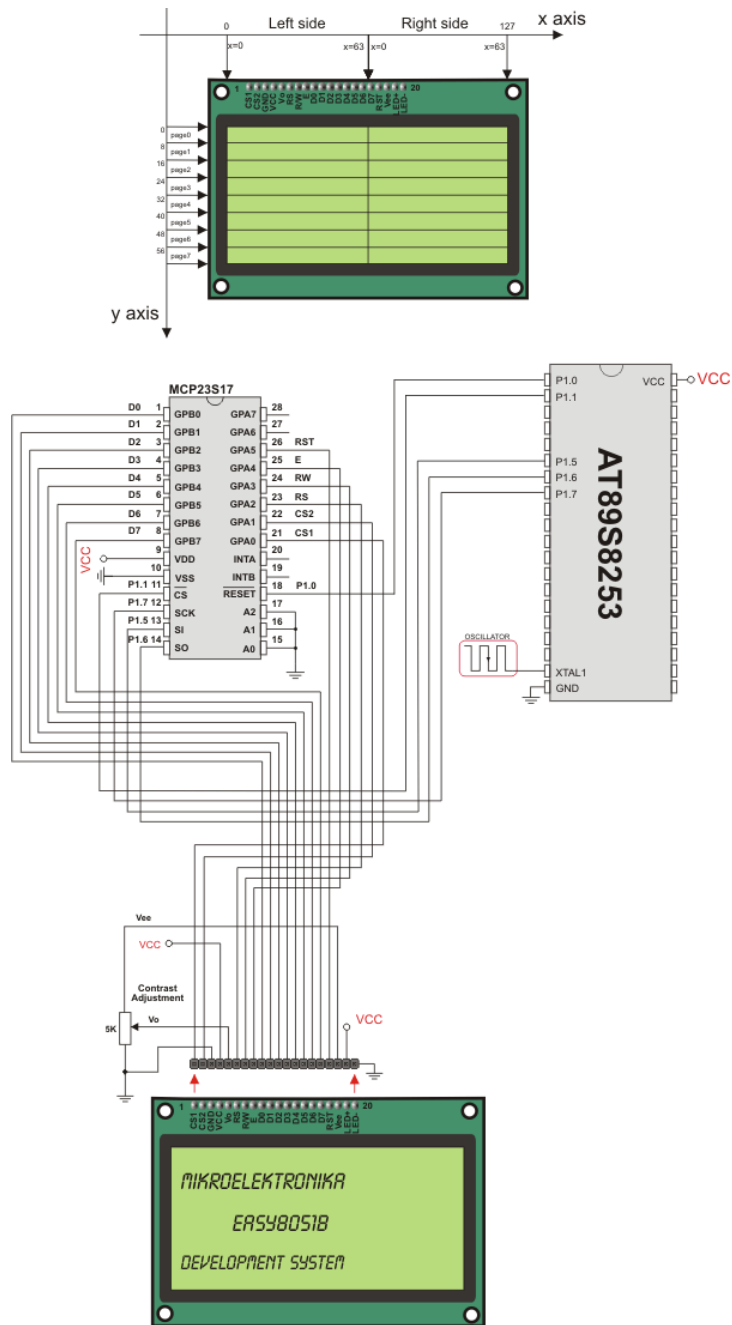

SPI GLCD HW connection

SPI LCD LIBRARY

The *mikroPascal for 8051* provides a library for communication with LCD (with HD44780 compliant controllers) in 4-bit mode via SPI interface.

For creating a custom set of LCD characters use LCD Custom Character Tool.

Note: The library uses the SPI module for communication. The user must initialize the SPI module before using the SPI LCD Library.

Note: This Library is designed to work with the mikroElektronika's Serial LCD Adapter Board pinout. See schematic at the bottom of this page for details.

External dependencies of SPI LCD Library

The implementation of SPI LCD Library routines is based on Port Expander Library routines.

External dependencies are the same as Port Expander Library external dependencies.

Library Routines

- Spi_Lcd_Config
- Spi_Lcd_Out
- Spi_Lcd_Out_Cp
- Spi_Lcd_Chr
- Spi_Lcd_Chr_Cp
- Spi_Lcd_Cmd

Spi_Lcd_Config

Prototype	<code>procedure Spi_Lcd_Config(DeviceAddress: byte);</code>
Returns	Nothing.
Description	<p>Initializes the LCD module via SPI interface.</p> <p>Parameters :</p> <ul style="list-style-type: none"> - <code>DeviceAddress</code>: spi expander hardware address, see schematic at the bottom of this page
Requires	<p><code>SPExpanderCS</code> and <code>SPExpanderRST</code> variables must be defined before using this function.</p> <p>The SPI module needs to be initialized. See <code>Spi_Init</code> and <code>Spi_Init_Advanced</code> routines.</p>
Example	<pre>// port expander pinout definition var SPExpanderCS : sbit at P1.B1; SPExpanderRST : sbit at P1.B0; ... Spi_Init(); // initialize spi Spi_Lcd_Config(0); // initialize lcd over spi inter- face</pre>

Spi_Lcd_Out

Prototype	<code>procedure Spi_Lcd_Out(row: byte; column: byte; var text: string[20]);</code>
Returns	Nothing.
Description	<p>Prints text on the LCD starting from specified position. Both string variables and literals can be passed as a text.</p> <p>Parameters :</p> <ul style="list-style-type: none"> - <code>row</code>: starting position row number - <code>column</code>: starting position column number - <code>text</code>: text to be written
Requires	LCD needs to be initialized for SPI communication, see <code>Spi_Lcd_Config</code> routines.
Example	<pre>// Write text "Hello!" on LCD starting from row 1, column 3: Spi_Lcd_Out(1, 3, "Hello!");</pre>

Spi_Lcd_Out_Cp

Prototype	<code>procedure Spi_Lcd_Out_CP(text : string[20]);</code>
Returns	Nothing.
Description	Prints text on the LCD at current cursor position. Both string variables and literals can be passed as a text. Parameters : - <code>text</code> : text to be written
Requires	LCD needs to be initialized for SPI communication, see Spi_Lcd_Config routines.
Example	<code>// Write text "Here!" at current cursor position: Spi_Lcd_Out_CP("Here!");</code>

Spi_Lcd_Chr

Prototype	<code>procedure Spi_Lcd_Chr(Row : byte; Column : byte; Out_Char : byte);</code>
Returns	Nothing.
Description	Prints character on LCD at specified position. Both variables and literals can be passed as character. Parameters : - <code>Row</code> : writing position row number - <code>Column</code> : writing position column number - <code>Out_Char</code> : character to be written
Requires	LCD needs to be initialized for SPI communication, see Spi_Lcd_Config routines.
Example	<code>// Write character "i" at row 2, column 3: Spi_Lcd_Chr(2, 3, 'i');</code>

Spi_Lcd_Chrcp

Prototype	<code>procedure Spi_Lcd_Chrcp(Out_Char : byte);</code>
Returns	Nothing.
Description	Prints character on LCD at current cursor position. Both variables and literals can be passed as character. Parameters : - <code>Out_Char</code> : character to be written
Requires	LCD needs to be initialized for SPI communication, see Spi_Lcd_Config routines.
Example	<pre>// Write character "e" at current cursor position: Spi_Lcd_Chrcp('e');</pre>

Spi_Lcd_Cmd

Prototype	<code>procedure Spi_Lcd_Cmd(out_char : byte);</code>
Returns	Nothing.
Description	Sends command to LCD. Parameters : - <code>out_char</code> : command to be sent Note: Predefined constants can be passed to the function, see Available LCD Commands.
Requires	LCD needs to be initialized for SPI communication, see Spi_Lcd_Config routines.
Example	<pre>// Clear LCD display: Spi_Lcd_Cmd(LCD_CLEAR);</pre>

Available LCD Commands

Lcd Command	Purpose
LCD_FIRST_ROW	Move cursor to the 1st row
LCD_SECOND_ROW	Move cursor to the 2nd row
LCD_THIRD_ROW	Move cursor to the 3rd row
LCD_FOURTH_ROW	Move cursor to the 4th row
LCD_CLEAR	Clear display
LCD_RETURN_HOME	Return cursor to home position, returns a shifted display to its original position. Display data RAM is unaffected.
LCD_CURSOR_OFF	Turn off cursor
LCD_UNDERLINE_ON	Underline cursor on
LCD_BLINK_CURSOR_ON	Blink cursor on
LCD_MOVE_CURSOR_LEFT	Move cursor left without changing display data RAM
LCD_MOVE_CURSOR_RIGHT	Move cursor right without changing display data RAM
LCD_TURN_ON	Turn LCD display on
LCD_TURN_OFF	Turn LCD display off
LCD_SHIFT_LEFT	Shift display left without changing display data RAM
LCD_SHIFT_RIGHT	Shift display right without changing display data RAM

Library Example

This example demonstrates how to communicate LCD via the SPI module, using serial to parallel convertor MCP23S17.

```
program Spi_Lcd;

var text : array[16] of byte;

// Port Expander module connections
var SPExpanderRST : sbit at P1.B0;
var SPExpanderCS : sbit at P1.B1;
// End Port Expander module connections

begin
  text := 'mikroElektronika';
  Spi_Init(); // Initialize SPI
  Spi_Lcd_Config(0); // Initialize LCD over SPI inter-
face
  Spi_Lcd_Cmd(LCD_CLEAR); // Clear display
  Spi_Lcd_Cmd(LCD_CURSOR_OFF); // Turn cursor off
  Spi_Lcd_Out(1,6, 'mikroE'); // Print text to LCD, 1st row, 6th
column
  Spi_Lcd_Chr_CP('!'); // Append '!'
  Spi_Lcd_Out(2,1, text); // Print text to LCD, 2nd row, 1st
column
  Spi_Lcd_Out(3,1,'mikroE'); // For LCD with more than two rows
  Spi_Lcd_Out(4,15,'mikroE'); // For LCD with more than two rows
end.
```

HW Connection

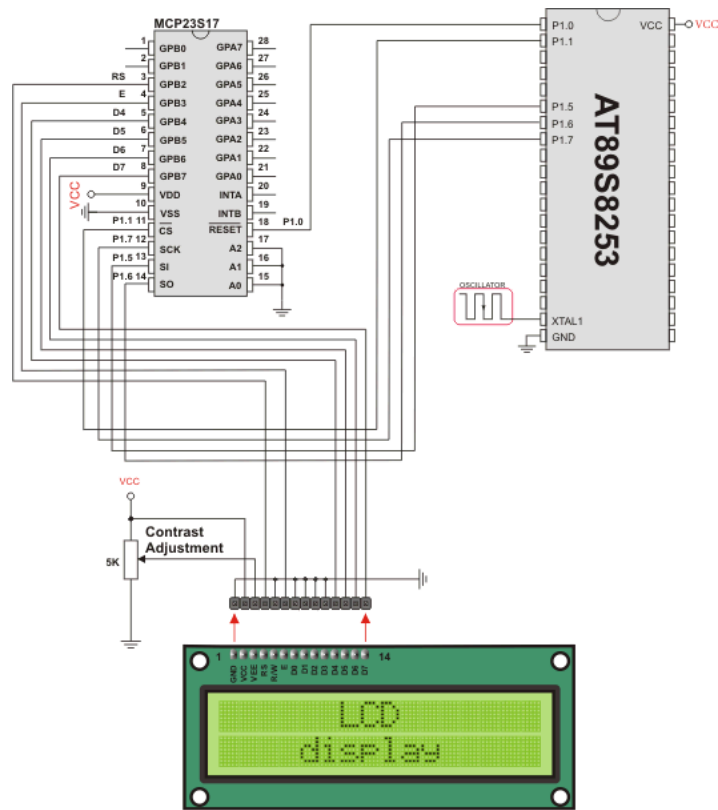

SPI LCD HW connection

SPI LCD8 (8-BIT INTERFACE) LIBRARY

The *mikroPascal for 8051* provides a library for communication with LCD (with HD44780 compliant controllers) in 8-bit mode via SPI interface.

For creating a custom set of LCD characters use LCD Custom Character Tool.

Note: Library uses the SPI module for communication. The user must initialize the SPI module before using the SPI LCD Library.

Note: This Library is designed to work with mikroElektronika's Serial LCD/GLCD Adapter Board pinout, see schematic at the bottom of this page for details.

External dependencies of SPI LCD Library

The implementation of SPI LCD Library routines is based on Port Expander Library routines.

External dependencies are the same as Port Expander Library external dependencies.

Library Routines

- Spi_Lcd8_Config
- Spi_Lcd8_Out
- Spi_Lcd8_Out_Cp
- Spi_Lcd8_Chr
- Spi_Lcd8_Chr_Cp
- Spi_Lcd8_Cmd

Spi_Lcd8_Config

Prototype	<code>procedure Spi_Lcd8_Config(DeviceAddress : byte);</code>
Returns	Nothing.
Description	<p>Initializes the LCD module via SPI interface.</p> <p>Parameters :</p> <ul style="list-style-type: none"> - <code>DeviceAddress</code>: spi expander hardware address, see schematic at the bottom of this page
Requires	<p><code>SPExpanderCS</code> and <code>SPExpanderRST</code> variables must be defined before using this function.</p> <p>The SPI module needs to be initialized. See <code>Spi_Init</code> and <code>Spi_Init_Advanced</code> routines.</p>
Example	<pre>// port expander pinout definition var SPExpanderCS : sbit at P1.B1; SPExpanderRST : sbit at P1.B0; ... Spi_Init(); // initialize spi interface Spi_Lcd8_Config(0); // initialize lcd in 8bit mode via spi</pre>

Spi_Lcd8_Out

Prototype	<code>procedure Spi_Lcd8_Out(row: byte; column: byte; var text: string[20]);</code>
Returns	Nothing.
Description	<p>Prints text on LCD starting from specified position. Both string variables and literals can be passed as a text.</p> <p>Parameters :</p> <ul style="list-style-type: none"> - <code>row</code>: starting position row number - <code>column</code>: starting position column number - <code>text</code>: text to be written
Requires	LCD needs to be initialized for SPI communication, see <code>Spi_Lcd8_Config</code> routines.
Example	<pre>// Write text "Hello!" on LCD starting from row 1, column 3: Spi_Lcd8_Out(1, 3, "Hello!");</pre>

Spi_Lcd8_Out_Cp

Prototype	<code>procedure Spi_Lcd8_Out_CP(text: string[20]);</code>
Returns	Nothing.
Description	Prints text on LCD at current cursor position. Both string variables and literals can be passed as a text. Parameters : - <code>text</code> : text to be written
Requires	LCD needs to be initialized for SPI communication, see Spi_Lcd8_Config routines.
Example	<pre>// Write text "Here!" at current cursor position: Spi_Lcd8_Out_Cp("Here!");</pre>

Spi_Lcd8_Chr

Prototype	<code>procedure Spi_Lcd8_Chr(Row : byte; Column : byte; Out_Char : byte);</code>
Returns	Nothing.
Description	Prints character on LCD at specified position. Both variables and literals can be passed as character. Parameters : - <code>row</code> : writing position row number - <code>column</code> : writing position column number - <code>out_char</code> : character to be written
Requires	LCD needs to be initialized for SPI communication, see Spi_Lcd8_Config routines.
Example	<pre>// Write character "i" at row 2, column 3: Spi_Lcd8_Chr(2, 3, 'i');</pre>

Spi_Lcd8_Chrcp

Prototype	<code>procedure Spi_Lcd8_Chrcp(Out_Char : byte);</code>
Returns	Nothing.
Description	Prints character on LCD at current cursor position. Both variables and literals can be passed as character. Parameters : - <code>out_char</code> : character to be written
Requires	LCD needs to be initialized for SPI communication, see Spi_Lcd8_Config routines.
Example	Print "e" at current cursor position: <code>// Write character "e" at current cursor position: Spi_Lcd8_Chrcp('e');</code>

Spi_Lcd8_Cmd

Prototype	<code>procedure Spi_Lcd8_Cmd(out_char : byte);</code>
Returns	Nothing.
Description	Sends command to LCD. Parameters : - <code>out_char</code> : command to be sent Note: Predefined constants can be passed to the function, see Available LCD Commands.
Requires	LCD needs to be initialized for SPI communication, see Spi_Lcd8_Config routines.
Example	<code>// Clear LCD display: Spi_Lcd8_Cmd(LCD_CLEAR);</code>

Available LCD Commands

Lcd Command	Purpose
LCD_FIRST_ROW	Move cursor to the 1st row
LCD_SECOND_ROW	Move cursor to the 2nd row
LCD_THIRD_ROW	Move cursor to the 3rd row
LCD_FOURTH_ROW	Move cursor to the 4th row
LCD_CLEAR	Clear display
LCD_RETURN_HOME	Return cursor to home position, returns a shifted display to its original position. Display data RAM is unaffected.
LCD_CURSOR_OFF	Turn off cursor
LCD_UNDERLINE_ON	Underline cursor on
LCD_BLINK_CURSOR_ON	Blink cursor on
LCD_MOVE_CURSOR_LEFT	Move cursor left without changing display data RAM
LCD_MOVE_CURSOR_RIGHT	Move cursor right without changing display data RAM
LCD_TURN_ON	Turn LCD display on
LCD_TURN_OFF	Turn LCD display off
LCD_SHIFT_LEFT	Shift display left without changing display data RAM
LCD_SHIFT_RIGHT	Shift display right without changing display data RAM

Library Example

This example demonstrates how to communicate LCD in 8-bit mode via the SPI module, using serial to parallel convertor MCP23S17.

```
program Spi_LCD8_Test;

var text : array[16] of byte;

// Port Expander module connections
var SPExpanderRST : sbit at P1.B0;
var SPExpanderCS : sbit at P1.B1;
// End Port Expander module connections

begin
    text := 'mikroElektronika';
    Spi_Init(); // Initialize SPI
interface
    Spi_Lcd8_Config(0); // Intialize LCD
in 8bit mode via SPI
    Spi_Lcd8_Cmd(LCD_CLEAR); // Clear display
    Spi_Lcd8_Cmd(LCD_CURSOR_OFF); // Turn cursor off
    Spi_Lcd8_Out(1,6, text); // Print text to
LCD, 1st row, 6th column...
    Spi_Lcd8_Chr_CP('!'); // Append '!'
    Spi_Lcd8_Out(2,1, 'mikroelektronika'); // Print text to LCD,
2nd row, 1st column...
    Spi_Lcd8_Out(3,1, text); // For LCD modules
with more than two rows
    Spi_Lcd8_Out(4,15, text); // For LCD modules
with more than two rows
end.
```

HW Connection

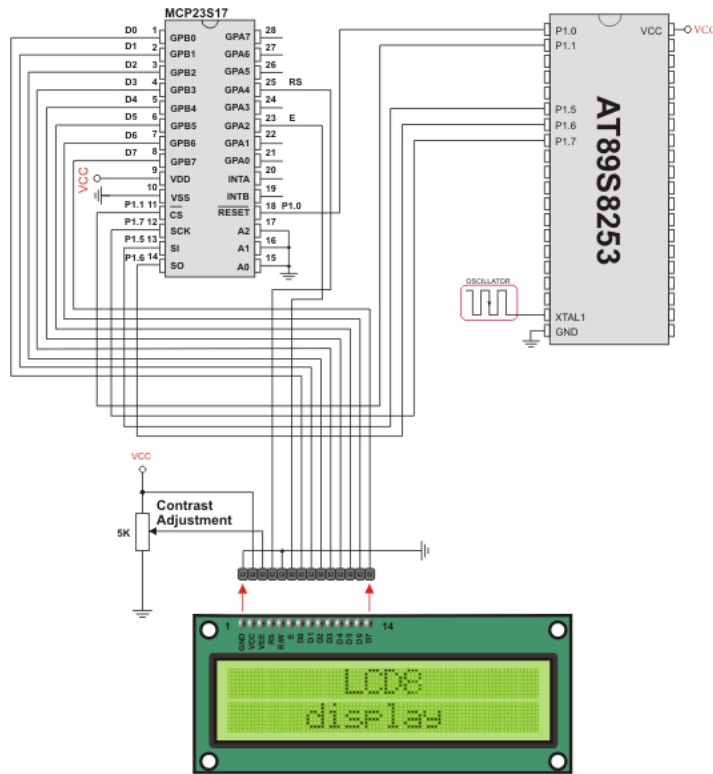

SPI LCD8 HW connection

SPI T6963C GRAPHIC LCD LIBRARY

The *mikroPascal for 8051* provides a library for working with GLCDs based on TOSHIBA T6963C controller via SPI interface. The Toshiba T6963C is a very popular LCD controller for the use in small graphics modules. It is capable of controlling displays with a resolution up to 240x128. Because of its low power and small outline it is most suitable for mobile applications such as PDAs, MP3 players or mobile measurement equipment. Although this controller is small, it has a capability of displaying and merging text and graphics and it manages all interfacing signals to the displays Row and Column drivers.

For creating a custom set of GLCD images use GLCD Bitmap Editor Tool.

Note: The library uses the SPI module for communication. The user must initialize SPI module before using the Spi T6963C GLCD Library.

Note: This Library is designed to work with mikroElektronika's Serial GLCD 240x128 and 240x64 Adapter Boards pinout, see schematic at the bottom of this page for details.

Note: Some mikroElektronika's adapter boards have pinout different from T6369C datasheets. Appropriate relations between these labels are given in the table below:

Adapter Board	T6369C datasheet
RS	C/D
R/W	/RD
E	/WR

External dependencies of Spi T6963C Graphic LCD Library

The implementation of Spi T6963C Graphic LCD Library routines is based on Port Expander Library routines.

External dependencies are the same as Port Expander Library external dependencies.

Library Routines

- Spi_T6963C_Config
- Spi_T6963C_WriteData
- Spi_T6963C_WriteCommand
- Spi_T6963C_SetPtr
- Spi_T6963C_WaitReady
- Spi_T6963C_Fill
- Spi_T6963C_Dot
- Spi_T6963C_Write_Char
- Spi_T6963C_Write_Text
- Spi_T6963C_Line
- Spi_T6963C_Rectangle
- Spi_T6963C_Box
- Spi_T6963C_Circle
- Spi_T6963C_Image
- Spi_T6963C_Sprite
- Spi_T6963C_Set_Cursor

Note: The following low level library routines are implemented as macros. These macros can be found in the Spi_T6963C.h header file which is located in the SPI T6963C example projects folders.

- Spi_T6963C_ClearBit
- Spi_T6963C_SetBit
- Spi_T6963C_NegBit
- Spi_T6963C_DisplayGrPanel
- Spi_T6963C_DisplayTxtPanel
- Spi_T6963C_SetGrPanel
- Spi_T6963C_SetTxtPanel
- Spi_T6963C_PanelFill
- Spi_T6963C_GrFill
- Spi_T6963C_TxtFill
- Spi_T6963C_Cursor_Height
- Spi_T6963C_Graphics
- Spi_T6963C_Text
- Spi_T6963C_Cursor
- Spi_T6963C_Cursor_Blink

Spi_T6963C_Config

Prototype	<code>procedure Spi_T6963C_Config(width : word; height : byte; fntW : byte; DeviceAddress : byte; wr : byte; rd : byte; cd : byte; rst : byte);</code>
Returns	Nothing.
Description	<p>Initializes the Graphic Lcd controller.</p> <p>Parameters :</p> <ul style="list-style-type: none"> - <code>width</code>: width of the GLCD panel - <code>height</code>: height of the GLCD panel - <code>fntW</code>: font width - <code>DeviceAddress</code>: SPI expander hardware address, see schematic at the bottom of this page - <code>wr</code>: write signal pin on GLCD control port - <code>rd</code>: read signal pin on GLCD control port - <code>cd</code>: command/data signal pin on GLCD control port - <code>rst</code>: reset signal pin on GLCD control port <p>Display RAM organization: The library cuts RAM into panels : a complete panel is one graphics panel followed by a text panel (see schematic below).</p> <pre>schematic: +-----+ /\ + GRAPHICS PANEL #0 + + + + + + + +-----+ PANEL 0 + TEXT PANEL #0 + + + \ +-----+ /\ + GRAPHICS PANEL #1 + + + + + + + +-----+ PANEL 1 + TEXT PANEL #2 + + + +-----+ \</pre>
Requires	<p>SPExpanderCS and SPExpanderRST variables must be defined before using this function.</p> <p>The SPI module needs to be initialized. See the Spi_Init and Spi_Init_Advanced routines.</p>

Example	<pre>// port expander pinout definition var SPExpanderRST : sbit at P1.B0; var SPExpanderCS : sbit at P1.B1; ... Spi_Init_Advanced(MASTER_OSC_DIV4 OR CLK_IDLE_LOW OR IDLE_2_ACTIVE OR DATA_ORDER_MSB); Spi_T6963C_Config(240, 64, 8, 0, 1, 3, 4) ;</pre>
----------------	---

Spi_T6963C_WriteData

Prototype	<code>procedure Spi_T6963C_WriteData(Ddata : byte);</code>
Returns	Nothing.
Description	Writes data to T6963C controller via SPI interface. Parameters : - <i>Ddata</i> : data to be written
Requires	Toshiba GLCD module needs to be initialized. See Spi_T6963C_Config routine.
Example	<code>Spi_T6963C_WriteData(AddrL);</code>

Spi_T6963C_WriteCommand

Prototype	<code>procedure Spi_T6963C_WriteCommand(Ddata : byte);</code>
Returns	Nothing.
Description	Writes command to T6963C controller via SPI interface. Parameters : - <i>Ddata</i> : command to be written
Requires	Toshiba GLCD module needs to be initialized. See Spi_T6963C_Config routine.
Example	<code>Spi_T6963C_WriteCommand(Spi_T6963C_CURSOR_POINTER_SET);</code>

Spi_T6963C_SetPtr

Prototype	<code>procedure Spi_T6963C_SetPtr(p : word; c : byte);</code>
Returns	Nothing.
Description	Sets the memory pointer p for command c. Parameters : - p: address where command should be written - c: command to be written
Requires	SToshiba GLCD module needs to be initialized. See Spi_T6963C_Config routine.
Example	<code>Spi_T6963C_SetPtr(T6963C_grHomeAddr + start, T6963C_ADDRESS_POINTER_SET);</code>

Spi_T6963C_WaitReady

Prototype	<code>procedure Spi_T6963C_WaitReady();</code>
Returns	Nothing.
Description	Pools the status byte, and loops until Toshiba GLCD module is ready.
Requires	Toshiba GLCD module needs to be initialized. See Spi_T6963C_Config routine.
Example	<code>Spi_T6963C_WaitReady();</code>

Spi_T6963C_Fill

Prototype	<code>procedure Spi_T6963C_Fill(v : byte; start : word; len : word);</code>
Returns	Nothing.
Description	Fills controller memory block with given byte. Parameters : - v: byte to be written - start: starting address of the memory block - len: length of the memory block in bytes
Requires	Toshiba GLCD module needs to be initialized. See Spi_T6963C_Config routine.
Example	<code>Spi_T6963C_Fill(0x33; 0x00FF; 0x000F);</code>

Spi_T6963C_Dot

Prototype	<code>procedure Spi_T6963C_Dot(x : integer; y : integer; color : byte);</code>
Returns	Nothing.
Description	<p>Draws a dot in the current graphic panel of GLCD at coordinates (x, y).</p> <p>Parameters :</p> <ul style="list-style-type: none"> - <code>x</code>: dot position on x-axis - <code>y</code>: dot position on y-axis - <code>color</code>: color parameter. Valid values: Spi_T6963C_BLACK and Spi_T6963C_WHITE
Requires	Toshiba GLCD module needs to be initialized. See Spi_T6963C_Config routine.
Example	<code>Spi_T6963C_Dot(x0, y0, pcolor);</code>

Spi_T6963C_Write_Char

Prototype	<code>procedure Spi_T6963C_Write_Char(c : byte; x : byte; y : byte; mode : byte);</code>
Returns	Nothing.
Description	<p>Writes a char in the current text panel of GLCD at coordinates (x, y).</p> <p>Parameters :</p> <ul style="list-style-type: none"> - <code>c</code>: char to be written - <code>x</code>: char position on x-axis - <code>y</code>: char position on y-axis - <code>mode</code>: mode parameter. Valid values: Spi_T6963C_ROM_MODE_OR, Spi_T6963C_ROM_MODE_XOR, Spi_T6963C_ROM_MODE_AND and Spi_T6963C_ROM_MODE_TEXT <p>Mode parameter explanation:</p> <ul style="list-style-type: none"> - OR Mode: In the OR-Mode, text and graphics can be displayed and the data is logically "OR-ed". This is the most common way of combining text and graphics for example labels on buttons. - XOR-Mode: In this mode, the text and graphics data are combined via the logical "exclusive OR". This can be useful to display text in negative mode, i.e. white text on black background. - AND-Mode: The text and graphic data shown on display are combined via the logical "AND function". - TEXT-Mode: This option is only available when displaying just a text. The Text Attribute values are stored in the graphic area of display memory. <p>For more details see the T6963C datasheet.</p>
Requires	Toshiba GLCD module needs to be initialized. See Spi_T6963C_Config routine.
Example	<code>Spi_T6963C_Write_Char("A", 22, 23, AND);</code>

Spi_T6963C_Write_Text

Prototype	<code>procedure Spi_T6963C_Write_Text(str : ^byte; x : byte, y : byte; mode : byte);</code>
Returns	Nothing.
Description	<p>Writes text in the current text panel of GLCD at coordinates (x, y).</p> <p>Parameters :</p> <ul style="list-style-type: none"> - <code>str</code>: text to be written - <code>x</code>: text position on x-axis - <code>y</code>: text position on y-axis - <code>mode</code>: mode parameter. Valid values: Spi_T6963C_ROM_MODE_OR, Spi_T6963C_ROM_MODE_XOR, Spi_T6963C_ROM_MODE_AND and Spi_T6963C_ROM_MODE_TEXT <p>Mode parameter explanation:</p> <ul style="list-style-type: none"> - OR Mode: In the OR-Mode, text and graphics can be displayed and the data is logically “OR-ed”. This is the most common way of combining text and graphics for example labels on buttons. - XOR-Mode: In this mode, the text and graphics data are combined via the logical “exclusive OR”. This can be useful to display text in negative mode, i.e. white text on black background. - AND-Mode: The text and graphic data shown on the display are combined via the logical “AND function”. - TEXT-Mode: This option is only available when displaying just a text. The Text Attribute values are stored in the graphic area of display memory. <p>For more details see the T6963C datasheet.</p>
Requires	Toshiba GLCD module needs to be initialized. See Spi_T6963C_Config routine.
Example	<code>Spi_T6963C_Write_Text('GLCD LIBRARY DEMO, WELCOME !', 0, 0, T6963C_ROM_MODE_EXOR);</code>

Spi_T6963C_Line

Prototype	<code>procedure Spi_T6963C_Line(x0 : integer; y0 : integer; x1 : integer; y1 : integer; pcolor : byte);</code>
Returns	Nothing.
Description	<p>Draws a line from (x0, y0) to (x1, y1).</p> <p>Parameters :</p> <ul style="list-style-type: none"> - <code>x0</code>: x coordinate of the line start - <code>y0</code>: y coordinate of the line end - <code>x1</code>: x coordinate of the line start - <code>y1</code>: y coordinate of the line end - <code>pcolor</code>: color parameter. Valid values: Spi_T6963C_BLACK and Spi_T6963C_WHITE
Requires	Toshiba GLCD module needs to be initialized. See Spi_T6963C_Config routine.
Example	<code>Spi_T6963C_Line(0, 0, 239, 127, T6963C_WHITE);</code>

Spi_T6963C_Rectangle

Prototype	<code>procedure Spi_T6963C_Rectangle(x0 : integer; y0 : integer; x1 : integer; y1 : integer; pcolor : byte);</code>
Returns	Nothing.
Description	<p>Draws a rectangle on GLCD.</p> <p>Parameters :</p> <ul style="list-style-type: none"> - <code>x0</code>: x coordinate of the upper left rectangle corner - <code>y0</code>: y coordinate of the upper left rectangle corner - <code>x1</code>: x coordinate of the lower right rectangle corner - <code>y1</code>: y coordinate of the lower right rectangle corner - <code>pcolor</code>: color parameter. Valid values: Spi_T6963C_BLACK and Spi_T6963C_WHITE
Requires	Toshiba GLCD module needs to be initialized. See Spi_T6963C_Config routine.
Example	<code>Spi_T6963C_Rectangle(20, 20, 219, 107, T6963C_WHITE);</code>

Spi_T6963C_Box

Prototype	<code>procedure Spi_T6963C_Box(x0 : integer; y0 : integer; x1 : integer; y1 : integer; pcolor : byte);</code>
Returns	Nothing.
Description	Draws a box on the GLCD Parameters : - <code>x0</code> : x coordinate of the upper left box corner - <code>y0</code> : y coordinate of the upper left box corner - <code>x1</code> : x coordinate of the lower right box corner - <code>y1</code> : y coordinate of the lower right box corner - <code>pcolor</code> : color parameter. Valid values: Spi_T6963C_BLACK and Spi_T6963C_WHITE
Requires	Toshiba GLCD module needs to be initialized. See Spi_T6963C_Config routine.
Example	<code>Spi_T6963C_Box(0, 119, 239, 127, T6963C_WHITE);</code>

Spi_T6963C_Circle

Prototype	<code>procedure Spi_T6963C_Circle(x : integer; y : integer; r : longint; pcolor : byte);</code>
Returns	Nothing.
Description	Draws a circle on the GLCD. Parameters : - <code>x</code> : x coordinate of the circle center - <code>y</code> : y coordinate of the circle center - <code>r</code> : radius size - <code>pcolor</code> : color parameter. Valid values: Spi_T6963C_BLACK and Spi_T6963C_WHITE
Requires	Toshiba GLCD module needs to be initialized. See Spi_T6963C_Config routine.
Example	<code>Spi_T6963C_Circle(120, 64, 110, T6963C_WHITE);</code>

Spi_T6963C_Image

Prototype	<code>procedure Spi_T6963C_image(const pic : ^byte);</code>
Returns	Nothing.
Description	<p>Displays bitmap on GLCD.</p> <p>Parameters :</p> <ul style="list-style-type: none"> - <code>pic</code>: image to be displayed. Bitmap array can be located in both code and RAM memory (due to the <i>mikroPascal for 8051</i> pointer to const and pointer to RAM equivalency). <p>Use the mikroPascal's integrated GLCD Bitmap Editor (menu option Tools > GLCD Bitmap Editor) to convert image to a constant array suitable for displaying on GLCD.</p>
Requires	Toshiba GLCD module needs to be initialized. See Spi_T6963C_Config routine.
Example	<code>Spi_T6963C_Image(my_image);</code>

Spi_T6963C_Sprite

Prototype	<code>procedure Spi_T6963C_sprite(px, py, sx, sy : byte; const pic : ^byte);</code>
Returns	Nothing.
Description	<p>Fills graphic rectangle area (px, py) to (px+sx, py+sy) with custom size picture.</p> <p>Parameters :</p> <ul style="list-style-type: none"> - <code>px</code>: x coordinate of the upper left picture corner. Valid values: multiples of the font width - <code>py</code>: y coordinate of the upper left picture corner - <code>pic</code>: picture to be displayed - <code>sx</code>: picture width. Valid values: multiples of the font width - <code>sy</code>: picture height <p>Note: If <code>px</code> and <code>sx</code> parameters are not multiples of the font width they will be scaled to the nearest lower number that is a multiple of the font width.</p>
Requires	Toshiba GLCD module needs to be initialized. See Spi_T6963C_Config routine.
Example	<code>Spi_T6963C_Sprite(76, 4, einstein, 88, 119); // draw a sprite</code>

Spi_T6963C_Set_Cursor

Prototype	<code>procedure Spi_T6963C_set_cursor(x, y : byte);</code>
Returns	Nothing.
Description	Sets cursor to row x and column y. Parameters : - x: cursor position row number - y: cursor position column number
Requires	Toshiba GLCD module needs to be initialized. See Spi_T6963C_Config routine.
Example	<code>Spi_T6963C_Set_Cursor(cposx, cposy);</code>

Spi_T6963C_ClearBit

Prototype	<code>procedure Spi_T6963C_clearBit(b : byte);</code>
Returns	Nothing.
Description	Clears control port bit(s). Parameters : - b: bit mask. The function will clear bit x on control port if bit x in bit mask is set to 1.
Requires	Toshiba GLCD module needs to be initialized. See Spi_T6963C_Config routine.
Example	<code>// clear bits 0 and 1 on control port Spi_T6963C_ClearBit(0x03);</code>

Spi_T6963C_SetBit

Prototype	<code>procedure Spi_T6963C_setBit(b : byte);</code>
Returns	Nothing.
Description	Sets control port bit(s). Parameters : - b: bit mask. The function will set bit x on control port if bit x in bit mask is set to 1.
Requires	Toshiba GLCD module needs to be initialized. See Spi_T6963C_Config routine.
Example	<code>// set bits 0 and 1 on control port Spi_T6963C_SetBit(0x03);</code>

Spi_T6963C_NegBit

Prototype	<code>procedure Spi_T6963C_negBit(b : byte);</code>
Returns	Nothing.
Description	Negates control port bit(s). Parameters : - b : bit mask. The function will negate bit x on control port if bit x in bit mask is set to 1.
Requires	Toshiba GLCD module needs to be initialized. See Spi_T6963C_Config routine.
Example	<pre>// negate bits 0 and 1 on control port Spi_T6963C_NegBit(0x03);</pre>

Spi_T6963C_DisplayGrPanel

Prototype	<code>procedure Spi_T6963C_DisplayGrPanel(n : byte);</code>
Returns	Nothing.
Description	Display selected graphic panel. Parameters : - n : graphic panel number. Valid values: 0 and 1.
Requires	Toshiba GLCD module needs to be initialized. See Spi_T6963C_Config routine.
Example	<pre>// display graphic panel 1 Spi_T6963C_DisplayGrPanel(1);</pre>

Spi_T6963C_DisplayTxtPanel

Prototype	<code>procedure Spi_T6963C_DisplayTxtPanel(n : byte);</code>
Returns	Nothing.
Description	Display selected text panel. Parameters : - n : text panel number. Valid values: 0 and 1.
Requires	Toshiba GLCD module needs to be initialized. See Spi_T6963C_Config routine.
Example	<pre>// display text panel 1 Spi_T6963C_DisplayTxtPanel(1);</pre>

Spi_T6963C_SetGrPanel

Prototype	<code>procedure Spi_T6963C_SetGrPanel(n : byte);</code>
Returns	Nothing.
Description	Compute start address for selected graphic panel and set appropriate internal pointers. All subsequent graphic operations will be preformed at this graphic panel. Parameters : - n: graphic panel number. Valid values: 0 and 1.
Requires	Toshiba GLCD module needs to be initialized. See Spi_T6963C_Config routine.
Example	<pre>// set graphic panel 1 as current graphic panel. Spi_T6963C_SetGrPanel(1);</pre>

Spi_T6963C_SetTxtPanel

Prototype	<code>procedure Spi_T6963C_SetTxtPanel(n : byte);</code>
Returns	Nothing.
Description	Compute start address for selected text panel and set appropriate internal pointers. All subsequent text operations will be preformed at this text panel. Parameters : - n: text panel number. Valid values: 0 and 1.
Requires	Toshiba GLCD module needs to be initialized. See Spi_T6963C_Config routine.
Example	<pre>// set text panel 1 as current text panel. Spi_T6963C_SetTxtPanel(1);</pre>

Spi_T6963C_PanelFill

Prototype	<code>procedure Spi_T6963C_PanelFill(v : byte);</code>
Returns	Nothing.
Description	Fill current panel in full (graphic+text) with appropriate value (0 to clear). Parameters : - v : value to fill panel with.
Requires	Toshiba GLCD module needs to be initialized. See Spi_T6963C_Config routine.
Example	<pre>clear current panel Spi_T6963C_PanelFill(0);</pre>

Spi_T6963C_GrFill

Prototype	<code>procedure Spi_T6963C_GrFill(v : byte);</code>
Returns	Nothing.
Description	Fill current graphic panel with appropriate value (0 to clear). Parameters : - v : value to fill graphic panel with.
Requires	Toshiba GLCD module needs to be initialized. See Spi_T6963C_Config routine.
Example	<pre>// clear current graphic panel Spi_T6963C_GrFill(0);</pre>

Spi_T6963C_TxtFill

Prototype	<code>procedure Spi_T6963C_TxtFill(v : byte);</code>
Returns	Nothing.
Description	Fill current text panel with appropriate value (0 to clear). Parameters : - v : this value increased by 32 will be used to fill text panel.
Requires	Toshiba GLCD module needs to be initialized. See Spi_T6963C_Config routine.
Example	<pre>// clear current text panel Spi_T6963C_TxtFill(0);</pre>

Spi_T6963C_Cursor_Height

Prototype	<code>procedure Spi_T6963C_Cursor_Height(n : byte);</code>
Returns	Nothing.
Description	Set cursor size. Parameters : - <i>n</i> : cursor height. Valid values: 0..7.
Requires	Toshiba GLCD module needs to be initialized. See Spi_T6963C_Config routine.
Example	<code>Spi_T6963C_Cursor_Height(7);</code>

Spi_T6963C_Graphics

Prototype	<code>procedure Spi_T6963C_Graphics(n : byte);</code>
Returns	Nothing.
Description	Enable/disable graphic displaying. Parameters : - <i>n</i> : graphic enable/disable parameter. Valid values: 0 (disable graphic displaying) and 1 (enable graphic displaying).
Requires	Toshiba GLCD module needs to be initialized. See Spi_T6963C_Config routine.
Example	<code>// enable graphic displaying Spi_T6963C_Graphics(1);</code>

Spi_T6963C_Text

Prototype	<code>procedure Spi_T6963C_Text(n : byte);</code>
Returns	Nothing.
Description	Enable/disable text displaying. Parameters : - <i>n</i> : text enable/disable parameter. Valid values: 0 (disable text displaying) and 1 (enable text displaying).
Requires	Toshiba GLCD module needs to be initialized. See Spi_T6963C_Config routine.
Example	<code>// enable text displaying Spi_T6963C_Text(1);</code>

Spi_T6963C_Cursor

Prototype	<code>procedure Spi_T6963C_Cursor(n : byte);</code>
Returns	Nothing.
Description	Set cursor on/off. Parameters : - n : on/off parameter. Valid values: 0 (set cursor off) and 1 (set cursor on).
Requires	Toshiba GLCD module needs to be initialized. See Spi_T6963C_Config routine.
Example	<pre>// set cursor on Spi_T6963C_Cursor(1);</pre>

Spi_T6963C_Cursor_Blink

Prototype	<code>procedure Spi_T6963C_Cursor_Blink(n : byte);</code>
Returns	Nothing.
Description	Enable/disable cursor blinking. Parameters : - n : cursor blinking enable/disable parameter. Valid values: 0 (disable cursor blinking) and 1 (enable cursor blinking).
Requires	Toshiba GLCD module needs to be initialized. See Spi_T6963C_Config routine.
Example	<pre>// enable cursor blinking Spi_T6963C_Cursor_Blink(1);</pre>

Library Example

The following drawing demo tests advanced routines of the Spi T6963C GLCD library. Hardware configurations in this example are made for the T6963C 240x128 display, Easy8051B board and AT89S8253.

```
#include          "Spi_T6963C.h"

/*
 * bitmap pictures stored in ROM
 */
extern const code char mc[] ;
extern const code char einstein[] ;

// Port Expander module connections
sbit SPExpanderRST at P1.B0;
sbit SPExpanderCS  at P1.B1;
// End Port Expander module connections

procedure main() {

    char idata txt1[] = " EINSTEIN WOULD HAVE LIKED mC";
    char idata txt[] = " GLCD LIBRARY DEMO, WELCOME !";

    byte   panel ;           // current panel
    word   i ;              // general purpose register
    byte   curs ;          // cursor visibility
    word   cposx, cposy ;  // cursor x-y position

    P0 = 255;                // Configure PORT0 as input

    /*
     * init display for 240 pixel width and 128 pixel height
     * 8 bits character width
     * data bus on MCP23S17 portB
     * control bus on MCP23S17 portA
     * bit 2 is !WR
     * bit 1 is !RD
     * bit 0 is !CD
     * bit 4 is RST
     *
     * chip enable, reverse on, 8x8 font internally set in library
     */

    // Initialize SPI module
    Spi_Init_Advanced(MASTER_OSC_DIV4 OR CLK_IDLE_LOW OR IDLE_2_ACTIVE
OR DATA_ORDER_MSB);
    // Initialize SPI Toshiba 240x128
    Spi_T6963C_Config(240, 128, 8, 0, 2, 1, 0, 4) ;
    Delay_ms(1000);
    /*
     * Enable both graphics and text display at the same time
     */
    Spi_T6963C_graphics(1) ;
    Spi_T6963C_text(1) ;
```

```
panel = 0 ;
i = 0 ;
curs = 0 ;
cposx = cposy = 0 ;

/*
 * Text messages
 */
Spi_T6963C_write_text(txt, 0, 0, Spi_T6963C_ROM_MODE_XOR) ;
Spi_T6963C_write_text(txt1, 0, 15, Spi_T6963C_ROM_MODE_XOR) ;

/*
 * Cursor
 */
Spi_T6963C_cursor_height(8) ;           // 8 pixel height
Spi_T6963C_set_cursor(0, 0) ;          // move cursor to top left
Spi_T6963C_cursor(0) ;                 // cursor off

/*
 * Draw rectangles
 */
Spi_T6963C_rectangle(0, 0, 239, 127, Spi_T6963C_WHITE) ;
Spi_T6963C_rectangle(20, 20, 219, 107, Spi_T6963C_WHITE) ;
Spi_T6963C_rectangle(40, 40, 199, 87, Spi_T6963C_WHITE) ;
Spi_T6963C_rectangle(60, 60, 179, 67, Spi_T6963C_WHITE) ;

/*
 * Draw a cross
 */
Spi_T6963C_line(0, 0, 239, 127, Spi_T6963C_WHITE) ;
Spi_T6963C_line(0, 127, 239, 0, Spi_T6963C_WHITE) ;

/*
 * Draw solid boxes
 */
Spi_T6963C_box(0, 0, 239, 8, Spi_T6963C_WHITE) ;
Spi_T6963C_box(0, 119, 239, 127, Spi_T6963C_WHITE) ;

/*
 * Draw circles
 */
Spi_T6963C_circle(120, 64, 10, Spi_T6963C_WHITE) ;
Spi_T6963C_circle(120, 64, 30, Spi_T6963C_WHITE) ;
Spi_T6963C_circle(120, 64, 50, Spi_T6963C_WHITE) ;
Spi_T6963C_circle(120, 64, 70, Spi_T6963C_WHITE) ;
Spi_T6963C_circle(120, 64, 90, Spi_T6963C_WHITE) ;
Spi_T6963C_circle(120, 64, 110, Spi_T6963C_WHITE) ;
Spi_T6963C_circle(120, 64, 130, Spi_T6963C_WHITE) ;
```

```
Spi_T6963C_sprite(76, 4, einstein, 88, 119) ; // Draw a sprite

Spi_T6963C_setGrPanel(1) ; // Select other
graphic panel

Spi_T6963C_image(mc) ; // Fill the graph-
ic screen with a picture

for(;;) { // Endless loop

    /*
    * If P0_0 is pressed, toggle the display between graphic panel
    0 and graphic 1
    */
    if(!P0_0) {
        panel++ ;
        panel &= 1 ;
        Spi_T6963C_displayGrPanel(panel) ;
        Delay_ms(300) ;
    }

    /*
    * If P0_1 is pressed, display only graphic panel
    */
    else if(!P0_1) {
        Spi_T6963C_graphics(1) ;
        Spi_T6963C_text(0) ;
        Delay_ms(300) ;
    }

    /*
    * If P0_2 is pressed, display only text panel
    */
    else if(!P0_2) {
        Spi_T6963C_graphics(0) ;
        Spi_T6963C_text(1) ;
        Delay_ms(300) ;
    }

    /*
    * If P0_3 is pressed, display text and graphic panels
    */
    else if(!P0_3) {
        Spi_T6963C_graphics(1) ;
        Spi_T6963C_text(1) ;
        Delay_ms(300) ;
    }
}
```



```
/*
 * If P0_4 is pressed, change cursor
 */
else if(!P0_4) {
    curs++;
    if(curs == 3) curs = 0;
    switch(curs) {
        case 0:
            // no cursor
            Spi_T6963C_cursor(0);
            break;
        case 1:
            // blinking cursor
            Spi_T6963C_cursor(1);
            Spi_T6963C_cursor_blink(1);
            break;
        case 2:
            // non blinking cursor
            Spi_T6963C_cursor(1);
            Spi_T6963C_cursor_blink(0);
            break;
    }
    Delay_ms(300);
}

/*
 * Move cursor, even if not visible
 */
cposx++;
if(cposx == Spi_T6963C_txtCols) {
    cposx = 0;
    cposy++;
    if(cposy == Spi_T6963C_grHeight / Spi_T6963C_CHARACTER_HEIGHT)
{
    cposy = 0;
}
}
Spi_T6963C_set_cursor(cposx, cposy);

Delay_ms(100);
}
```

HW Connection

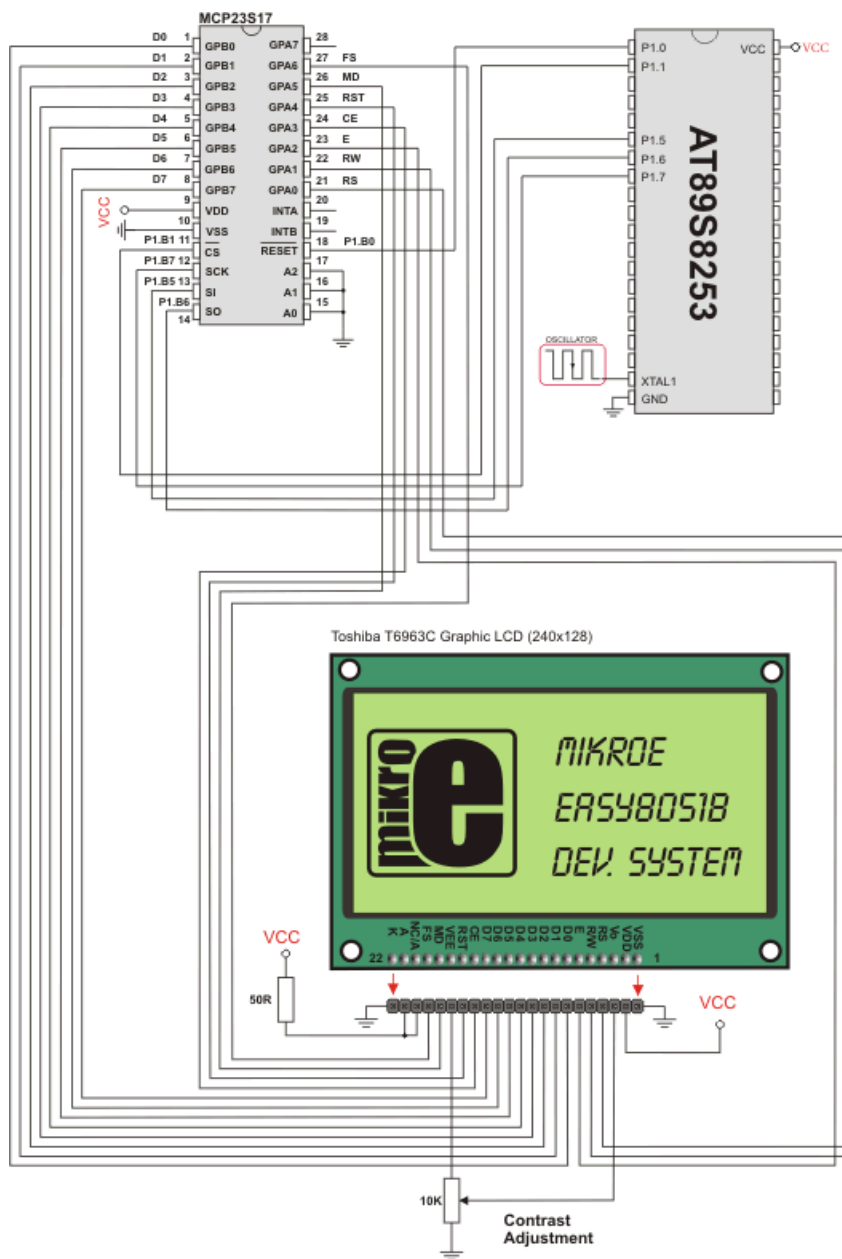

Spi T6963C GLCD HW connection

T6963C GRAPHIC LCD LIBRARY

The *mikroPascal for 8051* provides a library for working with GLCDs based on TOSHIBA T6963C controller. The Toshiba T6963C is a very popular LCD controller for the use in small graphics modules. It is capable of controlling displays with a resolution up to 240x128. Because of its low power and small outline it is most suitable for mobile applications such as PDAs, MP3 players or mobile measurement equipment. Although small, this controller has a capability of displaying and merging text and graphics and it manages all the interfacing signals to the displays Row and Column drivers.

For creating a custom set of GLCD images use GLCD Bitmap Editor Tool.

Note: ChipEnable(CE), FontSelect(FS) and Reverse(MD) have to be set to appropriate levels by the user outside of the `T6963C_Init` function. See the Library Example code at the bottom of this page.

Note: Some mikroElektronika's adapter boards have pinout different from T6369C datasheets. Appropriate relations between these labels are given in the table below:

Adapter Board	T6369C datasheet
RS	C/D
R/W	/RD
E	/WR

External dependencies of T6963C Graphic LCD Library

The following variables must be defined in all projects using T6963C Graphic LCD library:	Description:	Example :
<code>var T6963C_dataPort : byte; external; sfr;</code>	T6963C Data Port.	<code>var T6963C_dataPort : byte at P0; sfr;</code>
<code>var T6963C_ctrlPort : byte; external; sfr;</code>	T6963C Control Port.	<code>var T6963C_ctrlPort : byte at P1; sfr;</code>
<code>var T6963C_ctrlwr : sbit; external;</code>	Write signal.	<code>var T6963C_ctrlwr : sbit at P1.B2;</code>
<code>var T6963C_ctrlrd : sbit external;</code>	Read signal.	<code>var T6963C_ctrlrd : sbit at P1.B1;</code>
<code>var T6963C_ctrlcd : sbit; external;</code>	Command/Data signal.	<code>var T6963C_ctrlcd : sbit at P1.B0;</code>
<code>var T6963C_ctrlrst : sbit; external;</code>	Reset signal.	<code>var T6963C_ctrlrst : sbit at P1.B4;</code>

Library Routines

- T6963C_Init
- T6963C_WriteData
- T6963C_WriteCommand
- T6963C_SetPtr
- T6963C_WaitReady
- T6963C_Fill
- T6963C_Dot
- T6963C_Write_Char
- T6963C_Write_Text
- T6963C_Line
- T6963C_Rectangle
- T6963C_Box
- T6963C_Circle
- T6963C_Image
- T6963C_Sprite
- T6963C_Set_Cursor

Note: The following low level library routines are implemented as macros. These macros can be found in the `T6963C.h` header file which is located in the T6963C example projects folders.

- T6963C_ClearBit
- T6963C_SetBit
- T6963C_NegBit
- T6963C_DisplayGrPanel
- T6963C_DisplayTxtPanel
- T6963C_SetGrPanel
- T6963C_SetTxtPanel
- T6963C_PanelFill
- T6963C_GrFill
- T6963C_TxtFill
- T6963C_Cursor_Height
- T6963C_Graphics
- T6963C_Text
- T6963C_Cursor
- T6963C_Cursor_Blink

T6963C_Init

Prototype	<code>procedure T6963C_init(width : word; height, fntW : byte);</code>
Returns	Nothing.
Description	<p>Initializes the Graphic Lcd controller.</p> <p>Parameters :</p> <ul style="list-style-type: none"> - <code>width</code>: width of the GLCD panel - <code>height</code>: height of the GLCD panel - <code>fntW</code>: font width <p>Display RAM organization: The library cuts the RAM into panels : a complete panel is one graphics panel followed by a text panel (see schematic below).</p> <pre>schematic: +-----+ /\ + GRAPHICS PANEL #0 + + + + + + + +-----+ PANEL 0 + TEXT PANEL #0 + + + \/\ +-----+ /\ + GRAPHICS PANEL #1 + + + + + + + +-----+ PANEL 1 + TEXT PANEL #2 + + + +-----+ \/\</pre>
Requires	<p>Global variables :</p> <ul style="list-style-type: none"> - <code>T6963C_dataPort</code> : Data Port - <code>T6963C_ctrlPort</code> : Control Port - <code>T6963C_ctrlwr</code> : write signal pin - <code>T6963C_ctrlrd</code> : read signal pin - <code>T6963C_ctrlcd</code> : command/data signal pin - <code>T6963C_ctrlrst</code> : reset signal pin <p>must be defined before using this function.</p>

Example	<pre>// T6963GLCD pinout definition var T6963C_dataPort : byte at P0; sfr; // pointer to DATA BUS port var T6963C_ctrlPort : byte at P1; sfr; // pointer to CONTROL BUS port var T6963C_ctrlwr : sbit at P1.B2; // WR write signal var T6963C_ctrlrd : sbit at P1.B1; // RD read signal var T6963C_ctrlcd : sbit at P1.B0; // CD command/data signal var T6963C_ctrlrst : sbit at P1.B4; // RST reset signal ... // init display for 240 pixel width, 128 pixel height and 8 bits character width T6963C_init(240, 128, 8);</pre>
----------------	--

T6963C_WriteData

Prototype	<code>procedure T6963C_WriteData(mydata : byte);</code>
Returns	Nothing.
Description	Writes data to T6963C controller. Parameters : - <code>mydata</code> : data to be written
Requires	Toshiba GLCD module needs to be initialized. See the T6963C_Init routine.
Example	<code>T6963C_WriteData(AddrL);</code>

T6963C_WriteCommand

Prototype	<code>procedure T6963C_WriteCommand(mydata : byte);</code>
Returns	Nothing.
Description	Writes command to T6963C controller. Parameters : - <code>mydata</code> : command to be written
Requires	Toshiba GLCD module needs to be initialized. See the T6963C_Init routine.
Example	<code>T6963C_WriteCommand(T6963C_CURSOR_POINTER_SET);</code>

T6963C_SetPtr

Prototype	<code>procedure T6963C_SetPtr(p : word; c : byte);</code>
Returns	Nothing.
Description	Sets the memory pointer p for command c. Parameters : - p: address where command should be written - c: command to be written
Requires	Toshiba GLCD module needs to be initialized. See the T6963C_Init routine.
Example	<code>T6963C_SetPtr(T6963C_grHomeAddr + start, T6963C_ADDRESS_POINTER_SET);</code>

T6963C_WaitReady

Prototype	<code>procedure T6963C_WaitReady();</code>
Returns	Nothing.
Description	Pools the status byte, and loops until Toshiba GLCD module is ready.
Requires	Toshiba GLCD module needs to be initialized. See the T6963C_Init routine.
Example	<code>T6963C_WaitReady();</code>

T6963C_Fill

Prototype	<code>procedure T6963C_Fill(v : byte; start, len : word);</code>
Returns	Nothing.
Description	Fills controller memory block with given byte. Parameters : - v: byte to be written - start: starting address of the memory block - len: length of the memory block in bytes
Requires	Toshiba GLCD module needs to be initialized. See the T6963C_Init routine.
Example	<code>T6963C_Fill(0x33, 0x00FF, 0x000F);</code>

T6963C_Dot

Prototype	<code>procedure T6963C_Dot(x, y : integer; color : byte);</code>
Returns	Nothing.
Description	<p>Draws a dot in the current graphic panel of GLCD at coordinates (x, y).</p> <p>Parameters :</p> <ul style="list-style-type: none"> - <code>x</code>: dot position on x-axis - <code>y</code>: dot position on y-axis - <code>color</code>: color parameter. Valid values: T6963C_BLACK and T6963C_WHITE
Requires	Toshiba GLCD module needs to be initialized. See the T6963C_Init routine.
Example	<code>T6963C_Dot(x0, y0, pcolor);</code>

T6963C_Write_Char

Prototype	<code>procedure T6963C_Write_Char(c, x, y, mode : byte);</code>
Returns	Nothing.
Description	<p>Writes a char in the current text panel of GLCD at coordinates (x, y).</p> <p>Parameters :</p> <ul style="list-style-type: none"> - <code>c</code>: char to be written - <code>x</code>: char position on x-axis - <code>y</code>: char position on y-axis - <code>mode</code>: mode parameter. Valid values: T6963C_ROM_MODE_OR, T6963C_ROM_MODE_XOR, T6963C_ROM_MODE_AND and T6963C_ROM_MODE_TEXT <p>Mode parameter explanation:</p> <ul style="list-style-type: none"> - OR Mode: In the OR-Mode, text and graphics can be displayed and the data is logically “OR-ed”. This is the most common way of combining text and graphics for example labels on buttons. - XOR-Mode: In this mode, the text and graphics data are combined via the logical “exclusive OR”. This can be useful to display text in the negative mode, i.e. white text on black background. - AND-Mode: The text and graphic data shown on display are combined via the logical “AND function”. - TEXT-Mode: This option is only available when displaying just a text. The Text Attribute values are stored in the graphic area of display memory. <p>For more details see the T6963C datasheet.</p>
Requires	Toshiba GLCD module needs to be initialized. See the T6963C_Init routine.
Example	<code>T6963C_Write_Char('A',22,23,AND);</code>

T6963C_Write_Text

Prototype	<code>procedure T6963C_Write_Text(str : ^byte; x, y, mode : byte);</code>
Returns	Nothing.
Description	<p>Writes text in the current text panel of GLCD at coordinates (x, y).</p> <p>Parameters :</p> <ul style="list-style-type: none"> - <code>str</code>: text to be written - <code>x</code>: text position on x-axis - <code>y</code>: text position on y-axis - <code>mode</code>: mode parameter. Valid values: T6963C_ROM_MODE_OR, T6963C_ROM_MODE_XOR, T6963C_ROM_MODE_AND and T6963C_ROM_MODE_TEXT <p>Mode parameter explanation:</p> <ul style="list-style-type: none"> - OR Mode: In the OR-Mode, text and graphics can be displayed and the data is logically “OR-ed”. This is the most common way of combining text and graphics for example labels on buttons. - XOR-Mode: In this mode, the text and graphics data are combined via the logical “exclusive OR”. This can be useful to display text in the negative mode, i.e. white text on black background. - AND-Mode: The text and graphic data shown on display are combined via the logical “AND function”. - TEXT-Mode: This option is only available when displaying just a text. The Text Attribute values are stored in the graphic area of display memory. <p>For more details see the T6963C datasheet.</p>
Requires	Toshiba GLCD module needs to be initialized. See the T6963C_Init routine.
Example	<code>T6963C_Write_Text(" GLCD LIBRARY DEMO, WELCOME !", 0, 0, T6963C_ROM_MODE_XOR);</code>

T6963C_Line

Prototype	<code>procedure T6963C_Line(x0, y0, x1, y1 : integer; pcolor : byte);</code>
Returns	Nothing.
Description	<p>Draws a line from (x0, y0) to (x1, y1).</p> <p>Parameters :</p> <ul style="list-style-type: none"> - <code>x0</code>: x coordinate of the line start - <code>y0</code>: y coordinate of the line end - <code>x1</code>: x coordinate of the line start - <code>y1</code>: y coordinate of the line end - <code>pcolor</code>: colajor parameter. Valid values: T6963C_BLACK and T6963C_WHITE
Requires	Toshiba GLCD module needs to be initialized. See the T6963C_Init routine.
Example	<code>T6963C_Line(0, 0, 239, 127, T6963C_WHITE);</code>

T6963C_Rectangle

Prototype	<code>procedure T6963C_Rectangle(x0, y0, x1, y1 : integer; pcolor : byte)</code>
Returns	Nothing.
Description	<p>Draws a rectangle on GLCD.</p> <p>Parameters :</p> <ul style="list-style-type: none"> - <code>x0</code>: x coordinate of the upper left rectangle corner - <code>y0</code>: y coordinate of the upper left rectangle corner - <code>x1</code>: x coordinate of the lower right rectangle corner - <code>y1</code>: y coordinate of the lower right rectangle corner - <code>pcolor</code>: color parameter. Valid values: T6963C_BLACK and T6963C_WHITE
Requires	Toshiba GLCD module needs to be initialized. See the T6963C_Init routine.
Example	<code>T6963C_Rectangle(20, 20, 219, 107, T6963C_WHITE);</code>

T6963C_Box

Prototype	<code>procedure T6963C_Box(x0, y0, x1, y1 : integer; pcolor : byte);</code>
Returns	Nothing.
Description	Draws a box on GLCD Parameters : <ul style="list-style-type: none">- <code>x0</code>: x coordinate of the upper left box corner- <code>y0</code>: y coordinate of the upper left box corner- <code>x1</code>: x coordinate of the lower right box corner- <code>y1</code>: y coordinate of the lower right box corner- <code>pcolor</code>: color parameter. Valid values: T6963C_BLACK and T6963C_WHITE
Requires	Toshiba GLCD module needs to be initialized. See the T6963C_Init routine.
Example	<code>T6963C_Box(0, 119, 239, 127, T6963C_WHITE);</code>

T6963C_Circle

Prototype	<code>procedure T6963C_Circle(x, y : integer; r : longint; pcolor : byte);</code>
Returns	Nothing.
Description	Draws a circle on GLCD. Parameters : <ul style="list-style-type: none">- <code>x</code>: x coordinate of the circle center- <code>y</code>: y coordinate of the circle center- <code>r</code>: radius size- <code>pcolor</code>: color parameter. Valid values: T6963C_BLACK and T6963C_WHITE
Requires	Toshiba GLCD module needs to be initialized. See the T6963C_Init routine.
Example	<code>T6963C_Circle(120, 64, 110, T6963C_WHITE);</code>

T6963C_Image

Prototype	<code>procedure T6963C_Image(const pic : ^byte);</code>
Returns	Nothing.
Description	<p>Displays bitmap on GLCD.</p> <p>Parameters :</p> <ul style="list-style-type: none"> - <code>pic</code>: image to be displayed. Bitmap array can be located in both code and RAM memory (due to the <i>mikroPascal for 8051</i> pointer to const and pointer to RAM equivalency). <p>Use the mikroPascal's integrated GLCD Bitmap Editor (menu option Tools › GLCD Bitmap Editor) to convert image to a constant array suitable for displaying on GLCD.</p>
Requires	Toshiba GLCD module needs to be initialized. See the T6963C_Init routine.
Example	<code>T6963C_Image(mc);</code>

T6963C_Sprite

Prototype	<code>procedure T6963C_Sprite(px, py, sx, sy : byte; const pic : ^byte);</code>
Returns	Nothing.
Description	<p>Fills graphic rectangle area (px, py) to (px+sx, py+sy) with custom size picture.</p> <p>Parameters :</p> <ul style="list-style-type: none"> - <code>px</code>: x coordinate of the upper left picture corner. Valid values: multiples of the font width - <code>py</code>: y coordinate of the upper left picture corner - <code>pic</code>: picture to be displayed - <code>sx</code>: picture width. Valid values: multiples of the font width - <code>sy</code>: picture height <p>Note: If <code>px</code> and <code>sx</code> parameters are not multiples of the font width they will be scaled to the nearest lower number that is a multiple of the font width.</p>
Requires	Toshiba GLCD module needs to be initialized. See the T6963C_Init routine.
Example	<code>T6963C_Sprite(76, 4, einstein, 88, 119); // draw a sprite</code>

T6963C_Set_Cursor

Prototype	<code>procedure T6963C_Set_Cursor(x, y : byte);</code>
Returns	Nothing.
Description	Sets cursor to row x and column y. Parameters : - x: cursor position row number - y: cursor position column number
Requires	Toshiba GLCD module needs to be initialized. See the T6963C_Init routine.
Example	<code>T6963C_Set_Cursor(cposx, cposy);</code>

T6963C_ClearBit

Prototype	<code>procedure T6963C_ClearBit(b : byte);</code>
Returns	Nothing.
Description	Clears control port bit(s). Parameters : - b: bit mask. The function will clear bit x on control port if bit x in bit mask is set to 1.
Requires	Toshiba GLCD module needs to be initialized. See the T6963C_Init routine.
Example	<code>// clear bits 0 and 1 on control port T6963C_ClearBit(0x03);</code>

T6963C_SetBit

Prototype	<code>procedure T6963C_SetBit(b : byte);</code>
Returns	Nothing.
Description	Sets control port bit(s). Parameters : - b: bit mask. The function will set bit x on control port if bit x in bit mask is set to 1.
Requires	Toshiba GLCD module needs to be initialized. See the T6963C_Init routine.
Example	<code>// set bits 0 and 1 on control port T6963C_SetBit(0x03);</code>

T6963C_NegBit

Prototype	<code>procedure T6963C_NegBit(b : byte);</code>
Returns	Nothing.
Description	Negates control port bit(s). Parameters : - b : bit mask. The function will negate bit x on control port if bit x in bit mask is set to 1.
Requires	Toshiba GLCD module needs to be initialized. See the T6963C_Init routine.
Example	<pre>// negate bits 0 and 1 on control port T6963C_NegBit(0x03);</pre>

T6963C_DisplayGrPanel

Prototype	<code>procedure T6963C_DisplayGrPanel(n : byte);</code>
Returns	Nothing.
Description	Display selected graphic panel. Parameters : - n : graphic panel number. Valid values: 0 and 1.
Requires	Toshiba GLCD module needs to be initialized. See the T6963C_Init routine.
Example	<pre>// display graphic panel 1 T6963C_DisplayGrPanel(1);</pre>

T6963C_DisplayTxtPanel

Prototype	<code>procedure T6963C_DisplayTxtPanel(n : byte);</code>
Returns	Nothing.
Description	Display selected text panel. Parameters : - n : text panel number. Valid values: 0 and 1.
Requires	Toshiba GLCD module needs to be initialized. See the T6963C_Init routine.
Example	<pre>// display text panel 1 T6963C_DisplayTxtPanel(1);</pre>

T6963C_SetGrPanel

Prototype	<code>procedure T6963C_SetGrPanel(n : byte);</code>
Returns	Nothing.
Description	<p>Compute start address for selected graphic panel and set appropriate internal pointers. All subsequent graphic operations will be preformed at this graphic panel.</p> <p>Parameters :</p> <p>- n: graphic panel number. Valid values: 0 and 1.</p>
Requires	Toshiba GLCD module needs to be initialized. See the T6963C_Init routine.
Example	<code>// set graphic panel 1 as current graphic panel. T6963C_SetGrPanel(1);</code>

T6963C_SetTxtPanel

Prototype	<code>procedure T6963C_SetTxtPanel(n : byte);</code>
Returns	Nothing.
Description	<p>Compute start address for selected text panel and set appropriate internal pointers. All subsequent text operations will be preformed at this text panel.</p> <p>Parameters :</p> <p>- n: text panel number. Valid values: 0 and 1.</p>
Requires	Toshiba GLCD module needs to be initialized. See the T6963C_Init routine.
Example	<code>// set text panel 1 as current text panel. T6963C_SetTxtPanel(1);</code>

T6963C_PanelFill

Prototype	<code>procedure T6963C_PanelFill(v : byte);</code>
Returns	Nothing.
Description	Fill current panel in full (graphic+text) with appropriate value (0 to clear). Parameters : - v : value to fill panel with.
Requires	Toshiba GLCD module needs to be initialized. See the T6963C_Init routine.
Example	<code>clear current panel T6963C_PanelFill(0);</code>

T6963C_GrFill

Prototype	<code>procedure T6963C_GrFill(v : byte);</code>
Returns	Nothing.
Description	Fill current graphic panel with appropriate value (0 to clear). Parameters : - v : value to fill graphic panel with.
Requires	Toshiba GLCD module needs to be initialized. See the T6963C_Init routine.
Example	<code>// clear current graphic panel T6963C_GrFill(0);</code>

T6963C_TxtFill

Prototype	<code>procedure T6963C_TxtFill(v : byte);</code>
Returns	Nothing.
Description	Fill current text panel with appropriate value (0 to clear). Parameters : - v : this value increased by 32 will be used to fill text panel.
Requires	Toshiba GLCD module needs to be initialized. See the T6963C_Init routine.
Example	<code>// clear current text panel T6963C_TxtFill(0);</code>

T6963C_Cursor_Height

Prototype	<code>procedure T6963C_Cursor_Height(n : byte);</code>
Returns	Nothing.
Description	Set cursor size. Parameters : - n : cursor height. Valid values: 0..7.
Requires	Toshiba GLCD module needs to be initialized. See the T6963C_Init routine.
Example	<code>T6963C_Cursor_Height(7);</code>

T6963C_Graphics

Prototype	<code>procedure T6963C_Graphics(n : byte);</code>
Returns	Nothing.
Description	Enable/disable graphic displaying. Parameters : - n : on/off parameter. Valid values: 0 (disable graphic displaying) and 1 (enable graphic displaying).
Requires	Toshiba GLCD module needs to be initialized. See the T6963C_Init routine.
Example	<code>// enable graphic displaying T6963C_Graphics(1);</code>

T6963C_Text

Prototype	<code>procedure T6963C_Text(n : byte);</code>
Returns	Nothing.
Description	Enable/disable text displaying. Parameters : - n : on/off parameter. Valid values: 0 (disable text displaying) and 1 (enable text displaying).
Requires	Toshiba GLCD module needs to be initialized. See the T6963C_Init routine.
Example	<code>// enable text displaying T6963C_Text(1);</code>

T6963C_Cursor

Prototype	<code>procedure T6963C_Cursor(n : byte);</code>
Returns	Nothing.
Description	Set cursor on/off. Parameters : - <i>n</i> : on/off parameter. Valid values: 0 (set cursor off) and 1 (set cursor on).
Requires	Toshiba GLCD module needs to be initialized. See the T6963C_Init routine.
Example	<pre>// set cursor on T6963C_Cursor(1);</pre>

T6963C_Cursor_Blink

Prototype	<code>procedure T6963C_Cursor_Blink(n : byte);</code>
Returns	Nothing.
Description	Enable/disable cursor blinking. Parameters : - <i>n</i> : on/off parameter. Valid values: 0 (disable cursor blinking) and 1 (enable cursor blinking).
Requires	Toshiba GLCD module needs to be initialized. See the T6963C_Init routine.
Example	<pre>// enable cursor blinking T6963C_Cursor_Blink(1);</pre>

Library Example

The following drawing demo tests advanced routines of the T6963C GLCD library. Hardware configurations in this example are made for the T6963C 240x128 display, Easy8051B board and AT89S8253.

```

program T6963C_240x128;

uses __Lib_T6963C_Consts, bitmap, bitmap2;

var
// T6963C module connections
  T6963C_dataPort : byte at P0; sfr ;      // DATA port
  T6963C_cntlPort : byte at P1; sfr ;      // CONTROL port

  T6963C_cntlwr   : sbit at P1.B2;         // WR write signal
  T6963C_cntlrd   : sbit at P1.B1;         // RD read signal
  T6963C_cntlcd   : sbit at P1.B0;         // CD command/data signal
  T6963C_cntlrst  : sbit at P1.B4;         // RST reset signal
// End T6963C module connections

var  panel : byte;           // current panel
      i : word;              // general purpose register
      curs : byte;          // cursor visibility
      cposx,
      cposy : word;         // cursor x-y position
      txtcols : byte;       // number of text coloms
      txt, txt1 : string[29]; idata ;

begin

  txt1 := ' EINSTEIN WOULD HAVE LIKED mC';
  txt  := ' GLCD LIBRARY DEMO, WELCOME !';

  P2 := 255; // all inputs
  // Clear T6963C ports
  P1 := 0;   // control bus
  P0 := 0;   // data bus

  {
  * init display for 240 pixel width and 128 pixel height
  * 8 bits character width
  * data bus on P0
  * control bus on P1
  * bit 2 is !WR
  * bit 1 is !RD
  * bit 0 is !CD
  * bit 4 is RST
  }
  T6963C_init(240, 128, 8) ;
  {
  *
  * enable both graphics and text display at the same time
  *
  }

```

```

T6963C_graphics(1) ;
    T6963C_text(1) ;

    panel := 0 ;
    i      := 0 ;
    curs  := 0 ;
    cposx := 0 ;
    cposy := 0 ;
    txtcols := 240 div 8;           // calculate number of
text colomns                       // (grafic display
width divided by font width)
{
*
* text messages
*
}
T6963C_write_text(txt, 0, 0, T6963C_ROM_MODE_XOR) ;
T6963C_write_text(txt1, 0, 15, T6963C_ROM_MODE_XOR) ;

{
*
* cursor
*
}
T6963C_cursor_height(8) ;           // 8 pixel height
T6963C_set_cursor(0, 0) ;           // move cursor to top left
T6963C_cursor(0) ;                 // cursor off

{
*
* draw rectangles
*
}
T6963C_rectangle(0, 0, 239, 127, T6963C_BLACK) ;
T6963C_rectangle(20, 20, 219, 107, T6963C_BLACK) ;
T6963C_rectangle(40, 40, 199, 87, T6963C_BLACK) ;
T6963C_rectangle(60, 60, 179, 67, T6963C_BLACK) ;

{
*
* draw a cross
*
}
T6963C_line(0, 0, 239, 127, T6963C_BLACK) ;
T6963C_line(0, 127, 239, 0, T6963C_BLACK) ;

{

```

```

    *
    * draw solid boxes
    *
}
T6963C_box(0, 0, 239, 8, T6963C_BLACK) ;
T6963C_box(0, 119, 239, 127, T6963C_BLACK) ;

{
*
* draw circles
*
}
T6963C_circle(120, 64, 10, T6963C_BLACK) ;
T6963C_circle(120, 64, 30, T6963C_BLACK) ;
T6963C_circle(120, 64, 50, T6963C_BLACK) ;
T6963C_circle(120, 64, 70, T6963C_BLACK) ;
T6963C_circle(120, 64, 90, T6963C_BLACK) ;
T6963C_circle(120, 64, 110, T6963C_BLACK) ;
T6963C_circle(120, 64, 130, T6963C_BLACK) ;

T6963C_sprite(76, 4, @einstein, 88, 119) ;
// draw a sprite

T6963C_setGrPanel(1) ; // select other graphic panel

T6963C_Image(@banner_bmp) ;

while true do
begin
{ *
* if P2_0 is pressed, toggle the display between graphic panel
0 and graphic 1
* }
if(P2_0 = 0) then
begin
panel := panel + 1;
panel := panel and 1 ;
T6963C_displayGrPanel(panel) ;
Delay_ms(300) ;
end

{ *
* if P2_1 is pressed, display only graphic panel
* }
else
if(P2_1 = 0) then
begin
T6963C_graphics(1) ;
T6963C_text(0) ;
Delay_ms(300) ;
end
end

```

```

    { *
    * if P2_3 is pressed, display text and graphic panels
    * }
    else
        if(P2_3 = 0) then
            begin
                T6963C_graphics(1) ;
                T6963C_text(1) ;
                Delay_ms(300) ;
            end

    { *
    * if P2_4 is pressed, change cursor
    * }
    else
        if(P2_4 = 0) then
            begin
                curs := curs + 1;
                if(curs = 3) then
                    curs := 0 ;
                case curs of
                    0:
                        T6963C_cursor(0) ;

                    1:
                        begin
                            T6963C_cursor(1) ;
                            T6963C_cursor_blink(1) ;
                        end;

                    2:
                        begin
                            T6963C_cursor(1) ;
                            T6963C_cursor_blink(0) ;
                        end;
                end;
                Delay_ms(300) ;
            end;

    { *
    * move cursor, even if not visible
    * }
    cposx := cposx + 1;
    if(cposx = txtcols) then
        begin
            cposx := 0 ;
            cposy := cposy + 1;
            if(cposy = (128 div T6963C_CHARACTER_HEIGHT)) then //
if y end
                cposy := 0 ; // grafic height (128) div character height
            end;
            T6963C_set_cursor(cposx, cposy) ;
            Delay_ms(100) ;
        end;
    end;
end.

```

UART LIBRARY

The UART hardware module is available with a number of 8051 compliant MCUs. The *mikroPascal for 8051* UART Library provides comfortable work with the Asynchronous (full duplex) mode.

Library Routines

- Uart_Init
- Uart_Data_Ready
- Uart_Read
- Uart_Write

Uart_Init

Prototype	<code>procedure Uart_Init(baud_rate: longint);</code>
Returns	Nothing.
Description	<p>Configures and initializes the UART module.</p> <p>The internal UART module module is set to:</p> <ul style="list-style-type: none"> - 8-bit data, no parity - 1 STOP bit - disabled automatic address recognition - timer1 as baudrate source (mod2 = autoreload 8bit timer) <p>Parameters :</p> <ul style="list-style-type: none"> - <code>baud_rate</code>: requested baud rate <p>Refer to the device data sheet for baud rates allowed for specific Fosc.</p>
Requires	MCU with the UART module and TIMER1 to be used as baudrate source.
Example	<pre>// Initialize hardware UART and establish communication at 2400 // bps Uart_Init(2400);</pre>

Uart_Data_Ready

Prototype	<code>function Uart_Data_Ready(): byte;</code>
Returns	- 1 if data is ready for reading - 0 if there is no data in the receive register
Description	The function tests if data in receive buffer is ready for reading.
Requires	MCU with the UART module. The UART module must be initialized before using this routine. See the Uart_Init routine.
Example	<pre>var receive: byte; ... // read data if ready if (Uart_Data_Ready()=1) then receive := Uart_Read();</pre>

Uart_Read

Prototype	<code>function Uart_Read(): byte;</code>
Returns	Received byte.
Description	The function receives a byte via UART. Use the Uart_Data_Ready function to test if data is ready first.
Requires	MCU with the UART module. The UART module must be initialized before using this routine. See Uart_Init routine.
Example	<pre>var receive: byte; ... // read data if ready if (Uart_Data_Ready()=1) then receive := Uart_Read();</pre>

Uart_Write

Prototype	<code>procedure Uart_Write(TxData: byte);</code>
Returns	Nothing.
Description	The function transmits a byte via the UART module. Parameters : - TxData: data to be sent
Requires	MCU with the UART module. The UART module must be initialized before using this routine. See Uart_Init routine.
Example	<code>var data: byte; ... data := 0x1E Uart_Write(data);</code>

Library Example

This example demonstrates simple data exchange via UART. If MCU is connected to the PC, you can test the example from the *mikroPascal for 8051* USART Terminal.

```

program UART;

var uart_rd : byte;

begin

    Uart_Init(4800);           // Initialize UART module at 4800 bps
    Delay_ms(100);           // Wait for UART module to stabilize

    while TRUE do           // Endless loop
    begin
        if (Uart_Data_Ready() <> 0) then // Check if UART module has received
data
            begin
                uart_rd := Uart_Read(); // Read data
                Uart_Write(uart_rd); // Send the same data back
            end;
    end;
end.

```

HW Connection

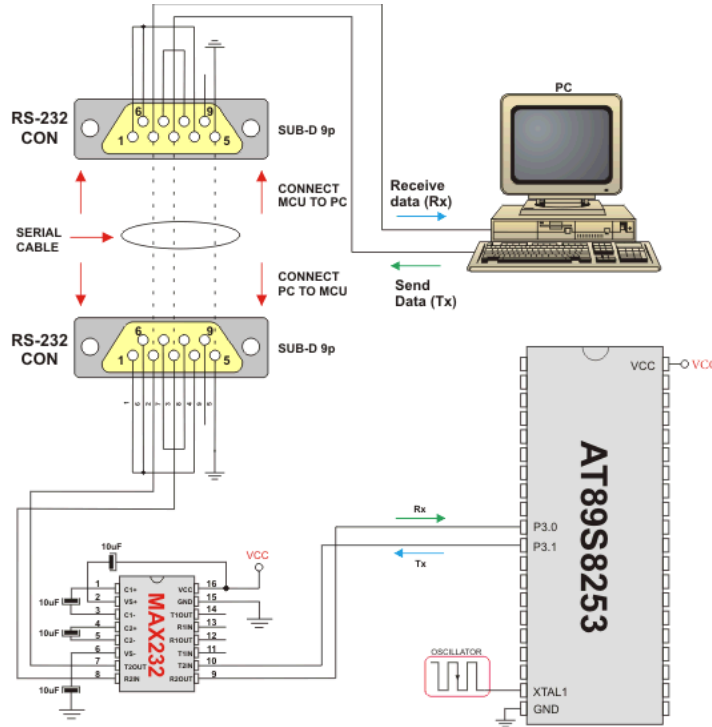

UART HW connection

BUTTON LIBRARY

The Button library contains miscellaneous routines useful for a project development.

External dependencies of Button Library

The following variable must be defined in all projects using Button library:	Description:	Example :
<code>var Button_Pin : sbit; external;</code>	Declares Button_Pin, which will be used by Button Library.	<code>var Button_Pin: sbit at P0.0;</code>

Library Routines

- Button

Button

Prototype	<code>function Button(time_ms : byte; active_state : byte) : byte;</code>
Returns	<ul style="list-style-type: none"> - 255 if the pin was in the active state for given period. - 0 otherwise
Description	<p>The function eliminates the influence of contact flickering upon pressing a button (debouncing). The Button pin is tested just after the function call and then again after the debouncing period has expired. If the pin was in the active state in both cases then the function returns 255 (true).</p> <p>Parameters :</p> <ul style="list-style-type: none"> - <code>time_ms</code> : debouncing period in milliseconds - <code>active_state</code>: determines what is considered as active state. Valid values: 0 (logical zero) and 1 (logical one)
Requires	<p><code>Button_Pin</code> variable must be defined before using this function.</p> <p>Button pin must be configured as input.</p>
Example	<pre>P2 is inverted on every P0.B0 one-to-zero transition : program Button_Test; // button connections var Button_Pin : sbit at P0.B0; // declare Button_Pin. It will be used by Button Library. // end Button connections oldstate : bit; begin P0 := 255; // configure PORT0 as input P2 := 0xAA; // initial PORT2 value while TRUE do begin if (Button(1, 1) <> 0) then // detect logical one oldstate := 1; // update flag if (oldstate and Button(1, 0)) then // detect one-to-zero transition begin P2 := not P2; // invert PORT2 oldstate := 0; // update flag end; end; // endless loop end. end.</pre>

CONVERSIONS LIBRARY

mikroPascal for 8051 Conversions Library provides routines for numerals to strings and BCD/decimal conversions.

Library Routines

You can get text representation of numerical value by passing it to one of the following routines:

- ByteToStr
- ShortToStr
- WordToStr
- IntToStr
- LongintToStr
- LongWordToStr
- FloatToStr

The following functions convert decimal values to BCD and vice versa:

- Dec2Bcd
- Bcd2Dec16
- Dec2Bcd16

ByteToStr

Prototype	<code>procedure ByteToStr(input : word; var output : string[2]);</code>
Returns	Nothing.
Description	<p>Converts input byte to a string. The output string is right justified and remaining positions on the left (if any) are filled with blanks.</p> <p>Parameters :</p> <ul style="list-style-type: none"> - <code>input</code>: byte to be converted - <code>output</code>: destination string
Requires	Nothing.
Example	<pre>var t : word; txt : string[2] ; ... t := 24; ByteToStr(t, txt); // txt is " 24" (one blank here)</pre>

ShortToStr

Prototype	<code>procedure ShortToStr(input : short; var output : string[3]);</code>
Returns	Nothing.
Description	<p>Converts input short (signed byte) number to a string. The output string is right justified and remaining positions on the left (if any) are filled with blanks.</p> <p>Parameters :</p> <ul style="list-style-type: none"> - <code>input</code>: short number to be converted - <code>output</code>: destination string
Requires	Nothing.
Example	<pre>var t : short; txt : array[4] ; ... t := -24; ByteToStr(t, txt); // txt is " -24" (one blank here)</pre>

WordToStr

Prototype	<code>procedure WordToStr(input : word; var output : string[4])</code>
Returns	Nothing.
Description	<p>Converts input word to a string. The output string is right justified and the remaining positions on the left (if any) are filled with blanks.</p> <p>Parameters :</p> <ul style="list-style-type: none"> - <code>input</code>: word to be converted - <code>output</code>: destination string
Requires	Nothing.
Example	<pre>var t : word; txt : string[4]; ... t := 437; WordToStr(t, txt); // txt is " 437" (two blanks here)</pre>

IntToStr

Prototype	<code>procedure IntToStr(input : integer; var output : string[5]);</code>
Returns	Nothing.
Description	<p>Converts input integer number to a string. The output string is right justified and the remaining positions on the left (if any) are filled with blanks.</p> <p>Parameters :</p> <ul style="list-style-type: none"> - <code>input</code>: integer number to be converted - <code>output</code>: destination string
Requires	Nothing.
Example	<pre>var input : integer; txt : string[5]; //... begin input := -4220; IntToStr(input, txt); // txt is ' -4220'</pre>

LongintToStr

Prototype	<code>procedure LongintToStr(input : longint; var output : string[10]);</code>
Returns	Nothing.
Description	<p>Converts input longint number to a string. The output string is right justified and the remaining positions on the left (if any) are filled with blanks.</p> <p>Parameters :</p> <ul style="list-style-type: none"> - <code>input</code>: longint number to be converted - <code>output</code>: destination string
Requires	Nothing.
Example	<pre>var input : longint; txt : string[10]; //... begin input := -12345678; IntToStr(input, txt); // txt is ' -12345678'</pre>

LongWordToStr

Prototype	<code>procedure LongWordToStr(input : dword; var output : string[9]);</code>
Returns	Nothing.
Description	<p>Converts input double word number to a string. The output string is right justified and the remaining positions on the left (if any) are filled with blanks.</p> <p>Parameters :</p> <ul style="list-style-type: none"> - <code>input</code>: double word number to be converted - <code>output</code>: destination string
Requires	Nothing.
Example	<pre>var input : longint; txt : string[9]; //... begin input := 12345678; IntToStr(input, txt); // txt is ' 12345678'</pre>

FloatToStr

Prototype	<code>function FloatToStr(input : real; var output : string[22]);</code>
Returns	<ul style="list-style-type: none"> - 3 if input number is NaN - 2 if input number is -INF - 1 if input number is +INF - 0 if conversion was successful
Description	<p>Converts a floating point number to a string.</p> <p>Parameters :</p> <ul style="list-style-type: none"> - <code>input</code>: floating point number to be converted - <code>output</code>: destination string <p>The output string is left justified and null terminated after the last digit.</p> <p>Note: Given floating point number will be truncated to 7 most significant digits before conversion.</p>
Requires	Nothing.
Example	<pre>var ff1, ff2, ff3 : real; txt : string[22]; ... ff1 := -374.2; ff2 := 123.456789; ff3 := 0.000001234; FloatToStr(ff1, txt); // txt is "-374.2" FloatToStr(ff2, txt); // txt is "123.4567" FloatToStr(ff3, txt); // txt is "1.234e-6"</pre>

Dec2Bcd

Prototype	<code>function Dec2Bcd(decnum : byte) : byte;</code>
Returns	Converted BCD value.
Description	Converts input number to its appropriate BCD representation. Parameters : - <code>decnum</code> : number to be converted
Requires	Nothing.
Example	<pre>var a, b : byte; ... a := 22; b := Dec2Bcd(a); // b equals 34</pre>

Bcd2Dec16

Prototype	<code>function Bcd2Dec16(bcdnum : word) : word;</code>
Returns	Converted decimal value.
Description	Converts 16-bit BCD numeral to its decimal equivalent. Parameters : - <code>bcdnum</code> : 16-bit BCD numeral to be converted
Requires	Nothing.
Example	<pre>var a, b : word; ... a := 0x1234; // a equals 4660 b := Bcd2Dec16(a); // b equals 1234</pre>

Dec2Bcd16

Prototype	<code>function Dec2Bcd16(decnum : word) : word;</code>
Returns	Converted BCD value.
Description	Converts decimal value to its BCD equivalent. Parameters : - <code>decnum</code> decimal number to be converted
Requires	Nothing.
Example	<pre>var a, b : word; ... a := 2345; b := Dec2Bcd16(a); // b equals 9029</pre>

MATH LIBRARY

The *mikroPascal for 8051* provides a set of library functions for floating point math handling. See also Predefined Globals and Constants for the list of predefined math constants.

Library Functions

- acos
- asin
- atan
- atan2
- ceil
- cos
- cosh
- eval_poly
- exp
- fabs
- floor
- frexp
- dexp
- log
- log10
- modf
- pow
- sin
- sinh
- sqrt
- tan
- tanh

acos

Prototype	<code>function acos(x : real) : real;</code>
Description	The function returns the arc cosine of parameter <code>x</code> ; that is, the value whose cosine is <code>x</code> . The input parameter <code>x</code> must be between -1 and 1 (inclusive). The return value is in radians, between 0 and π (inclusive).

asin

Prototype	<code>function asin(x : real) : real;</code>
Description	The function returns the arc sine of parameter <code>x</code> ; that is, the value whose sine is <code>x</code> . The input parameter <code>x</code> must be between -1 and 1 (inclusive). The return value is in radians, between $-\pi/2$ and $\pi/2$ (inclusive).

atan

Prototype	<code>function atan(arg : real) : real;</code>
Description	The function computes the arc tangent of parameter <code>arg</code> ; that is, the value whose tangent is <code>arg</code> . The return value is in radians, between $-\pi/2$ and $\pi/2$ (inclusive).

atan2

Prototype	<code>function atan2(y : real; x : real) : real;</code>
Description	This is the two-argument arc tangent function. It is similar to computing the arc tangent of <code>y/x</code> , except that the signs of both arguments are used to determine the quadrant of the result and <code>x</code> is permitted to be zero. The return value is in radians, between $-\pi$ and π (inclusive).

ceil

Prototype	<code>function ceil(x : real) : real;</code>
Description	The function returns value of parameter <code>x</code> rounded up to the next whole number.

cos

Prototype	<code>function cos(arg : real) : real;</code>
Description	The function returns the cosine of <code>arg</code> in radians. The return value is from -1 to 1.

cosh

Prototype	<code>function cosh(x : real) : real;</code>
Description	The function returns the hyperbolic cosine of <code>x</code> , defined mathematically as $(e^x + e^{-x}) / 2$. If the value of <code>x</code> is too large (if overflow occurs), the function fails.

eval_poly

Prototype	<code>function eval_poly(x : real; var d : array[10] of real; n : integer) : real;</code>
Description	Function Calculates polynom for number <code>x</code> , with coefficients stored in <code>d[]</code> , for degree <code>n</code> .

exp

Prototype	<code>function exp(x : real) : real;</code>
Description	The function returns the value of e — the base of natural logarithms — raised to the power <code>x</code> (i.e. e^x).

fabs

Prototype	<code>function fabs(d : real) : real;</code>
Description	The function returns the absolute (i.e. positive) value of <code>d</code> .

floor

Prototype	<code>function floor(x : real) : real;</code>
Description	The function returns the value of parameter <code>x</code> rounded down to the nearest integer.

frexp

Prototype	<code>function frexp(value : real; var eptr : integer) : real;</code>
Description	The function splits a floating-point value <code>value</code> into a normalized fraction and an integral power of 2. The return value is a normalized fraction and the integer exponent is stored in the object pointed to by <code>eptr</code> .

ldexp

Prototype	<code>function ldexp(value : real; newexp : integer) : real;</code>
Description	The function returns the result of multiplying the floating-point number <code>value</code> by 2 raised to the power <code>newexp</code> (i.e. returns <code>value * 2^{newexp}</code>).

log

Prototype	<code>function log(x : real) : real;</code>
Description	The function returns the natural logarithm of <code>x</code> (i.e. $\log_e(x)$).

log10

Prototype	<code>function log10(x : real) : real;</code>
Description	The function returns the base-10 logarithm of <code>x</code> (i.e. $\log_{10}(x)$).

modf

Prototype	<code>function modf(val : real; var iptr : real) : real;</code>
Description	The function returns the signed fractional component of <code>val</code> , placing its whole number component into the variable pointed to by <code>iptr</code> .

pow

Prototype	<code>function pow(x : real; y : real) : real;</code>
Description	The function returns the value of <code>x</code> raised to the power <code>y</code> (i.e. x^y). If <code>x</code> is negative, the function will automatically cast <code>y</code> into <code>longint</code> .

sin

Prototype	<code>function sin(arg : real) : real;</code>
Description	The function returns the sine of <code>arg</code> in radians. The return value is from -1 to 1.

sinh

Prototype	<code>function sinh(x : real) : real;</code>
Description	The function returns the hyperbolic sine of <code>x</code> , defined mathematically as $(e^x - e^{-x})/2$. If the value of <code>x</code> is too large (if overflow occurs), the function fails.

sqrt

Prototype	<code>function sqrt(x : real) : real;</code>
Description	The function returns the non negative square root of <code>x</code> .

tan

Prototype	<code>function tan(x : real) : real;</code>
Description	The function returns the tangent of <code>x</code> in radians. The return value spans the allowed range of floating point in <i>mikroPascal for 8051</i> .

tanh

Prototype	<code>function tanh(x : real) : real;</code>
Description	The function returns the hyperbolic tangent of <code>x</code> , defined mathematically as $\sinh(x)/\cosh(x)$.

STRING LIBRARY

The *mikroPascal for 8051* includes a library which automatizes string related tasks.

Library Functions

- memchr
- memcmp
- memcpy
- memmove
- memset
- strcat
- strchr
- strcmp
- strcpy
- strlen
- strncat
- strncpy
- strspn
- strcspn
- strncmp
- strpbrk
- strrchr
- strstr

memchr

Prototype	<code>function memchr(p : ^byte; ch : byte; n : byte) : byte;</code>
Description	<p>The function locates the first occurrence of the word <code>ch</code> in the initial <code>n</code> words of memory area starting at the address <code>p</code>. The function returns the offset of this occurrence from the memory address <code>p</code> or <code>0xFF</code> if <code>ch</code> was not found.</p> <p>For the parameter <code>p</code> you can use either a numerical value (literal/variable/constant) indicating memory address or a dereferenced value of an object, for example <code>@mystring</code> or <code>@PORTB</code>.</p>

memcmp

Prototype	<code>function memcmp(p1, p2 : ^byte; n : word) : short;</code>								
Description	<p>The function returns a positive, negative, or zero value indicating the relationship of first <code>n</code> words of memory areas starting at addresses <code>p1</code> and <code>p2</code>.</p> <p>This function compares two memory areas starting at addresses <code>p1</code> and <code>p2</code> for <code>n</code> words and returns a value indicating their relationship as follows:</p> <table border="0"> <thead> <tr> <th>Value</th> <th>Meaning</th> </tr> </thead> <tbody> <tr> <td><code>< 0</code></td> <td><code>p1 "less than" p2</code></td> </tr> <tr> <td><code>= 0</code></td> <td><code>p1 "equal to" p2</code></td> </tr> <tr> <td><code>> 0</code></td> <td><code>p1 "greater than" p2</code></td> </tr> </tbody> </table> <p>The value returned by the function is determined by the difference between the values of the first pair of words that differ in the strings being compared.</p> <p>For parameters <code>p1</code> and <code>p2</code> you can use either a numerical value (literal/variable/constant) indicating memory address or a dereferenced value of an object, for example <code>@mystring</code> or <code>@PORTB</code>.</p>	Value	Meaning	<code>< 0</code>	<code>p1 "less than" p2</code>	<code>= 0</code>	<code>p1 "equal to" p2</code>	<code>> 0</code>	<code>p1 "greater than" p2</code>
Value	Meaning								
<code>< 0</code>	<code>p1 "less than" p2</code>								
<code>= 0</code>	<code>p1 "equal to" p2</code>								
<code>> 0</code>	<code>p1 "greater than" p2</code>								

memcpy

Prototype	<code>procedure memcpy(p1, p2 : ^byte; nn : word);</code>
Description	<p>The function copies <code>nn</code> words from the memory area starting at the address <code>p2</code> to the memory area starting at <code>p1</code>. If these memory buffers overlap, the <code>memcpy</code> function cannot guarantee that words are copied before being overwritten. If these buffers do overlap, use the <code>memmove</code> function.</p> <p>For parameters <code>p1</code> and <code>p2</code> you can use either a numerical value (literal/variable/constant) indicating memory address or a dereferenced value of an object, for example <code>@mystring</code> or <code>@PORTB</code>.</p>

memmove

Prototype	<code>procedure memmove(p1, p2 : ^byte; nn : word);</code>
Description	<p>The function copies <code>nn</code> words from the memory area starting at the address <code>p2</code> to the memory area starting at <code>p1</code>. If these memory buffers overlap, the <code>Memmove</code> function ensures that the words in <code>p2</code> are copied to <code>p1</code> before being overwritten.</p> <p>For parameters <code>p1</code> and <code>p2</code> you can use either a numerical value (literal/variable/constant) indicating memory address or a dereferenced value of an object, for example <code>@mystring</code> or <code>@PORTB</code>.</p>

memset

Prototype	<code>procedure memset(p : ^byte; character : byte; n : word);</code>
Description	<p>The function fills the first <code>n</code> words in the memory area starting at the address <code>p</code> with the value of word <code>character</code>.</p> <p>For parameter <code>p</code> you can use either a numerical value (literal/variable/constant) indicating memory address or a dereferenced value of an object, for example <code>@mystring</code> or <code>@PORTB</code>.</p>

strcat

Prototype	<code>procedure strcat(var s1, s2 : string[100]);</code>
Description	The function appends the value of string <code>s2</code> to string <code>s1</code> and terminates <code>s1</code> with a null character.

strchr

Prototype	<code>function strchr(var s : string[100]; ch : byte) : byte;</code>
Description	<p>The function searches the string <code>s</code> for the first occurrence of the character <code>ch</code>. The null character terminating <code>s</code> is not included in the search.</p> <p>The function returns the position (index) of the first character <code>ch</code> found in <code>s</code>; if no matching character was found, the function returns <code>0xFF</code>.</p>

strcmp

Prototype	<code>function strcmp(var s1, s2 : string[100]) : integer;</code>								
Description	<p>The function lexicographically compares the contents of the strings <code>s1</code> and <code>s2</code> and returns a value indicating their relationship:</p> <table> <thead> <tr> <th>Value</th> <th>Meaning</th> </tr> </thead> <tbody> <tr> <td><code>< 0</code></td> <td><code>s1 "less than" s2</code></td> </tr> <tr> <td><code>= 0</code></td> <td><code>s1 "equal to" s2</code></td> </tr> <tr> <td><code>> 0</code></td> <td><code>s1 "greater than" s2</code></td> </tr> </tbody> </table> <p>The value returned by the function is determined by the difference between the values of the first pair of words that differ in the strings being compared.</p>	Value	Meaning	<code>< 0</code>	<code>s1 "less than" s2</code>	<code>= 0</code>	<code>s1 "equal to" s2</code>	<code>> 0</code>	<code>s1 "greater than" s2</code>
Value	Meaning								
<code>< 0</code>	<code>s1 "less than" s2</code>								
<code>= 0</code>	<code>s1 "equal to" s2</code>								
<code>> 0</code>	<code>s1 "greater than" s2</code>								

strcpy

Prototype	<code>procedure strcpy(var s1, s2 : string[100]);</code>
Description	The function copies the value of the string <code>s2</code> to the string <code>s1</code> and appends a null character to the end of <code>s1</code> .

strcspn

Prototype	<code>function strcspn(var s1, s2 : string[100]) : word;</code>
Description	<p>The function searches the string <code>s1</code> for any of the characters in the string <code>s2</code>.</p> <p>The function returns the index of the first character located in <code>s1</code> that matches any character in <code>s2</code>. If the first character in <code>s1</code> matches a character in <code>s2</code>, a value of 0 is returned. If there are no matching characters in <code>s1</code>, the length of the string is returned (not including the terminating null character).</p>

strlen

Prototype	<code>function strlen(var s : string[100]) : word;</code>
Description	The function returns the length, in words, of the string <i>s</i> . The length does not include the null terminating character.

strncat

Prototype	<code>procedure strncat(var s1, s2 : string[100]; size : byte);</code>
Description	The function appends at most <i>size</i> characters from the string <i>s2</i> to the string <i>s1</i> and terminates <i>s1</i> with a null character. If <i>s2</i> is shorter than the <i>size</i> characters, <i>s2</i> is copied up to and including the null terminating character.

strncmp

Prototype	<code>function strncmp(var s1, s2 : string[100]; len : byte) : integer;</code>								
Description	<p>The function lexicographically compares the first <i>len</i> words of the strings <i>s1</i> and <i>s2</i> and returns a value indicating their relationship:</p> <table border="1"> <thead> <tr> <th>Value</th> <th>Meaning</th> </tr> </thead> <tbody> <tr> <td>< 0</td> <td><i>s1</i> "less than" <i>s2</i></td> </tr> <tr> <td>= 0</td> <td><i>s1</i> "equal to" <i>s2</i></td> </tr> <tr> <td>> 0</td> <td><i>s1</i> "greater than" <i>s2</i></td> </tr> </tbody> </table> <p>The value returned by the function is determined by the difference between the values of the first pair of words that differ in the strings being compared (within first <i>len</i> words).</p>	Value	Meaning	< 0	<i>s1</i> "less than" <i>s2</i>	= 0	<i>s1</i> "equal to" <i>s2</i>	> 0	<i>s1</i> "greater than" <i>s2</i>
Value	Meaning								
< 0	<i>s1</i> "less than" <i>s2</i>								
= 0	<i>s1</i> "equal to" <i>s2</i>								
> 0	<i>s1</i> "greater than" <i>s2</i>								

strncpy

Prototype	<code>procedure strncpy(var s1, s2 : string[100]; size : byte);</code>
Description	The function copies at most <i>size</i> characters from the string <i>s2</i> to the string <i>s1</i> . If <i>s2</i> contains fewer characters than <i>size</i> , <i>s1</i> is padded out with null characters up to the total length of the <i>size</i> characters.

strpbrk

Prototype	<code>function strpbrk(var s1, s2 : string[100]) : byte;</code>
Description	The function searches <i>s1</i> for the first occurrence of any character from the string <i>s2</i> . The null terminator is not included in the search. The function returns an index of the matching character in <i>s1</i> . If <i>s1</i> contains no characters from <i>s2</i> , the function returns <code>0xFF</code> .

strchr

Prototype	<code>function strchr(var s : string[100]; ch : byte) : byte;</code>
Description	The function searches the string <code>s</code> for the last occurrence of the character <code>ch</code> . The null character terminating <code>s</code> is not included in the search. The function returns an index of the last <code>ch</code> found in <code>s</code> ; if no matching character was found, the function returns <code>0xFF</code> .

strspn

Prototype	<code>function strspn(var s1, s2 : string[100]) : word;</code>
Description	The function searches the string <code>s1</code> for characters not found in the <code>s2</code> string. The function returns the index of first character located in <code>s1</code> that does not match a character in <code>s2</code> . If the first character in <code>s1</code> does not match a character in <code>s2</code> , a value of 0 is returned. If all characters in <code>s1</code> are found in <code>s2</code> , the length of <code>s1</code> is returned (not including the terminating null character).

strstr

Prototype	<code>function strstr(var s1, s2 : string[100]) : word;</code>
Description	The function locates the first occurrence of the string <code>s2</code> in the string <code>s1</code> (excluding the terminating null character). The function returns a number indicating the position of the first occurrence of <code>s2</code> in <code>s1</code> ; if no string was found, the function returns <code>0xFF</code> . If <code>s2</code> is a null string, the function returns 0.

TIME LIBRARY

The Time Library contains functions and type definitions for time calculations in the UNIX time format which counts the number of seconds since the "epoch". This is very convenient for programs that work with time intervals: the difference between two UNIX time values is a real-time difference measured in seconds.

What is the epoch?

Originally it was defined as the beginning of 1970 GMT. (January 1, 1970 Julian day) GMT, Greenwich Mean Time, is a traditional term for the time zone in England.

The TimeStruct type is a structure type suitable for time and date storage.

Library Routines

- Time_dateToEpoch
- Time_epochToDate
- Time_datediff

Time_dateToEpoch

Prototype	<code>function Time_dateToEpoch(var ts : TimeStruct) : longint;</code>
Returns	Number of seconds since January 1, 1970 0h00mn00s.
Description	This function returns the UNIX time : number of seconds since January 1, 1970 0h00mn00s. Parameters : - <code>ts</code> : time and date value for calculating UNIX time.
Requires	Nothing.
Example	<pre>var ts1 : TimeStruct; Epoch : longint; ... // what is the epoch of the date in ts ? epoch := Time_dateToEpoch(ts1) ;</pre>

Time_epochToDate

Prototype	<code>procedure Time_epochToDate(e: longint; var ts : TimeStruct);</code>
Returns	Nothing.
Description	<p>Converts the UNIX time to time and date.</p> <p>Parameters :</p> <ul style="list-style-type: none"> - <code>e</code>: UNIX time (seconds since UNIX epoch) - <code>ts</code>: time and date structure for storing conversion output
Requires	Nothing.
Example	<pre>var ts2 : TimeStruct; epoch : longint; ... //what date is epoch 1234567890 ? epoch := 1234567890 ; Time_epochToDate(epoch,ts2);</pre>

Time_dateDiff

Prototype	<code>function Time_dateDiff(t1 : ^TimeStruct; t2 : ^TimeStruct) : longint ;</code>
Returns	Time difference in seconds as a signed long.
Description	<p>This function compares two dates and returns time difference in seconds as a signed long. The result is positive if <code>t1</code> is before <code>t2</code>, null if <code>t1</code> is the same as <code>t2</code> and negative if <code>t1</code> is after <code>t2</code>.</p> <p>Parameters :</p> <ul style="list-style-type: none"> - <code>t1</code>: time and date structure (the first comparison parameter) - <code>t2</code>: time and date structure (the second comparison parameter)
Requires	Nothing.
Example	<pre>var ts1, ts2 : TimeStruct; diff : longint; ... //how many seconds between these two dates contained in ts1 and ts2 buffers? diff := Time_dateDiff(ts1, ts2);</pre>

Library Example

Demonstration of Time library routines usage for time calculations in UNIX time format.

```
program Time_Demo;

program Time_Demo;

var epoch, diff : longint;

    ts1, ts2 : TimeStruct;

begin
    ts1.ss := 0 ;
    ts1.mn := 7 ;
    ts1.hh := 17 ;
    ts1.md := 23 ;
    ts1.mo := 5 ;
    ts1.yy := 2006 ;

    { *
      * What is the epoch of the date in ts ?
      * }
    epoch := Time_dateToEpoch(ts1) ;

    { *
      * What date is epoch 1234567890 ?
      * }
    epoch := 1234567890 ;
    Time_epochToDate(epoch, ts2) ;

    { *
      * How much seconds between this two dates ?
      * }
    diff := Time_dateDiff(ts1, ts2) ;
end.
```

TimeStruct type definition

```
type TimeStruct = record

    ss : byte ;    // seconds
    mn : byte ;    // minutes
    hh : byte ;    // hours
    md : byte ;    // day in month, from 1 to 31
    wd : byte ;    // day in week, monday=0, tuesday=1, ....
    sunday=6
    mo : byte ;    // month number, from 1 to 12 (and not from
0 to 11 as with unix C time !)
    yy : word ;    // year Y2K compliant, from 1892 to 2038
end;
```

TRIGONOMETRY LIBRARY

The *mikroPascal for 8051* implements fundamental trigonometry functions. These functions are implemented as look-up tables. Trigonometry functions are implemented in integer format in order to save memory.

Library Routines

- sinE3
- cosE3

sinE3

Prototype	<code>function sinE3(angle_deg : word) : integer;</code>
Returns	The function returns the sine of input parameter.
Description	<p>The function calculates sine multiplied by 1000 and rounded to the nearest integer:</p> <pre>result := round(sin(angle_deg)*1000)</pre> <p>Parameters:</p> <ul style="list-style-type: none">- <code>angle_deg</code>: input angle in degrees <p>Note: Return value range: <code>-1000..1000</code>.</p>
Requires	Nothing.
Example	<pre>var res : integer; ... res := sinE3(45); // result is 707</pre>

cosE3

Prototype	<code>function cosE3(angle_deg : word): integer;</code>
Returns	The function returns the cosine of input parameter.
Description	<p>The function calculates cosine multiplied by 1000 and rounded to the nearest integer:</p> <pre>result := round(cos(angle_deg)*1000)</pre> <p>Parameters:</p> <ul style="list-style-type: none">- <code>angle_deg</code>: input angle in degrees <p>Note: Return value range: <code>-1000..1000</code>.</p>
Requires	Nothing.
Example	<pre>var res: integer; ... res := cosE3(196); // result is -193</pre>



MikroElektronika

SOFTWARE AND HARDWARE SOLUTIONS

FOR EMBEDDED WORLD

...making it simple

If you have any other question, comment or a business proposal, please contact us:

web: www.mikroe.com

e-mail: office@mikroe.com

If you are experiencing problems with any of our products

or you just want additional information, please let us know. TECHNICAL SUPPORT:

www.mikroe.com/en/support

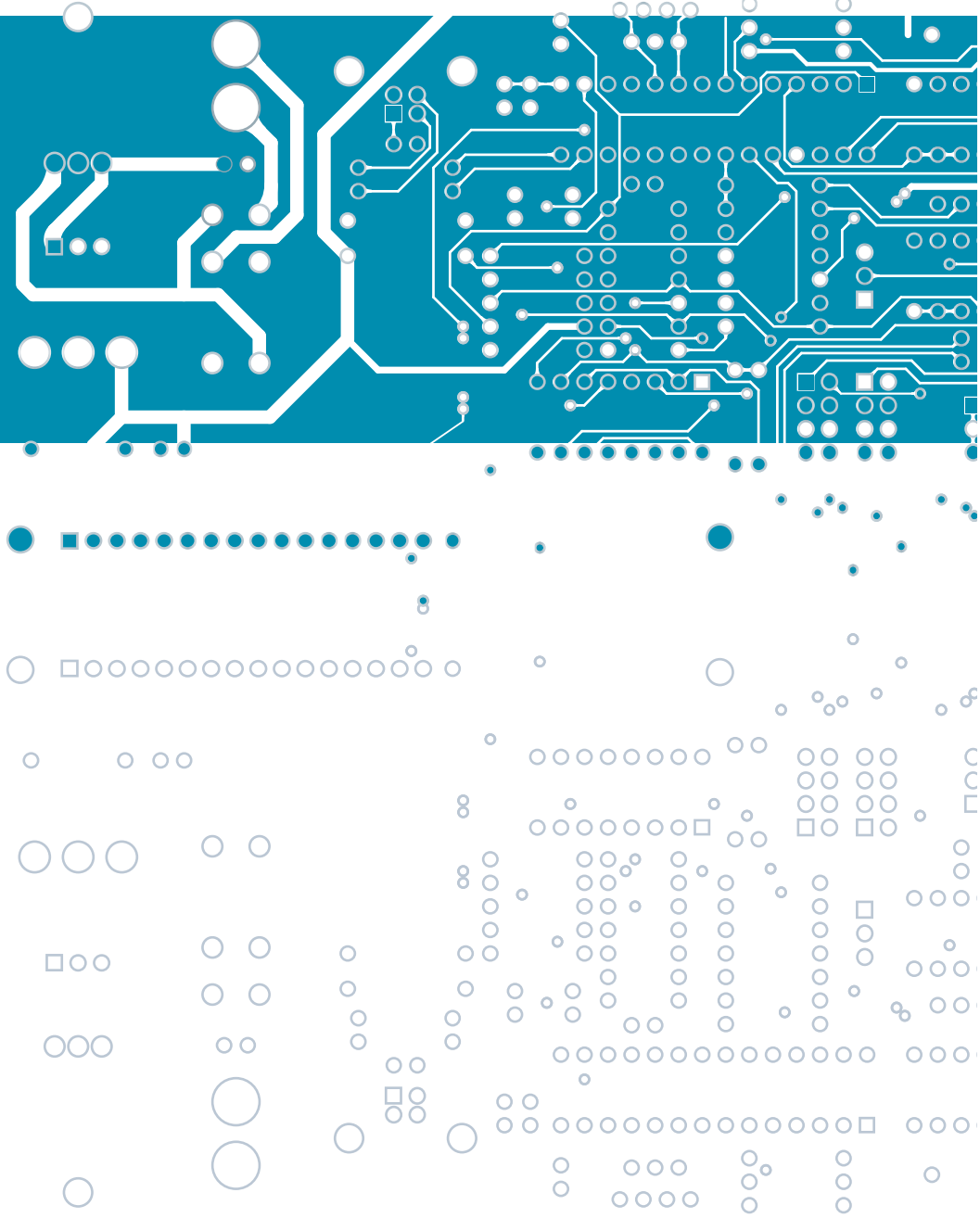

X-ON Electronics

Largest Supplier of Electrical and Electronic Components

Click to view similar products for [Development Software](#) category:

Click to view products by [MikroElektronika](#) manufacturer:

Other Similar products are found below :

[RAPPID-560XBSW](#) [RAPPID-567XFSW](#) [DG-ACC-NET-CD](#) [SRP004001-01](#) [SW006021-1NH](#) [SW163052](#) [SYSWINEV21](#) [Core429-SA](#)
[SW500006-HPA](#) [CWP-BASIC-FL](#) [W128E13](#) [CWP-PRO-FL](#) [SYSMACSE210L](#) [SYSMACSE203L](#) [AD-CCES-NODE-1](#) [NT-ZJCAT1-EV4](#)
[CWA-BASIC-FL](#) [RAPPID-567XKSW](#) [CWA-STANDARD-R](#) [SW89CN0-ZCC](#) [CWA-LS-DVLPR-NL](#) [VDSP-21XX-PCFLOAT](#) [RAPPID-](#)
[563XMSW](#) [IPS-EMBEDDED](#) [SWR-DRD-L-01](#) [SDAWIR-4532-01](#) [SYSMAC-SE201L](#) [MPROG-PRO535E](#) [AFLCF-08-LX-CE060-R21](#)
[WS02-CFSC1-EV3-UP](#) [SYSMAC-STUDIO-EIPCPLR](#) [LIB-PL-PC-N-1YR-DISKID](#) [SYSMACSE2XXL](#) [LS1043A-SWSP-PRM](#) [1120270005](#)
[1120270006](#) [MIKROBASIC PRO FOR FT90X \(USB DONGLE\)](#) [MIKROC PRO FOR AVR \(USB DONGLE LICENSE\)](#) [MIKROC PRO FOR](#)
[FT90X \(USB DONGLE\)](#) [MIKROBASIC PRO FOR AVR \(USB DONGLE LICEN](#) [MIKROBASIC PRO FOR FT90X](#) [MIKROC PRO FOR](#)
[DSPIC30/33 \(USB DONGLE LI](#) [MIKROC PRO FOR FT90X](#) [MIKROC PRO FOR PIC32 \(USB DONGLE LICENSE](#) [52202-588](#)
[MIKROPASCAL PRO FOR ARM \(USB DONGLE LICE](#) [MIKROPASCAL PRO FOR FT90X](#) [MIKROPASCAL PRO FOR FT90X \(USB](#)
[DONGLE\)](#) [MIKROPASCAL PRO FOR PIC32 \(USB DONGLE LI](#) [SW006021-2H](#)