

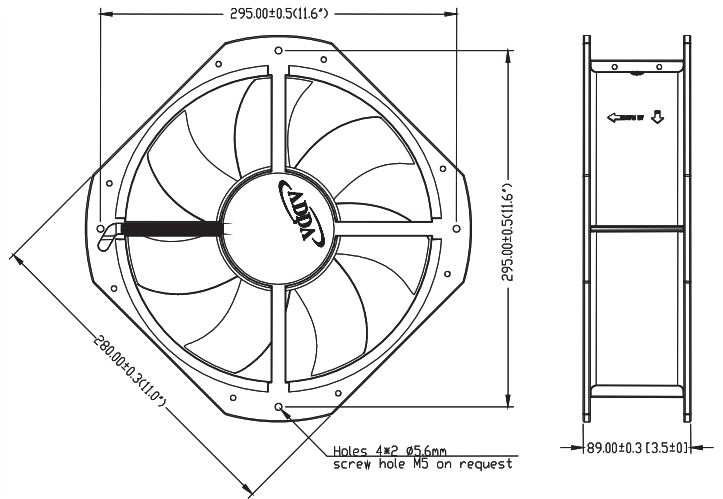

External Dimensions



Frame: Aluminum Alloy
 Impeller: Plastic (UL: 94V-0)
 Motor Structure: Capacitor-Run Induction Motor.
 Motor Protection: Thermal Protect.
 Bearing: Ball bearing
 Lead wire: UL 1332AWG18
 OPERATING TEMP*: -10°C~70°C
 *: -10°C~60°C for fans with sleeve/ball combination bearings.

Specifications(Nominal)

*Noise is measured at the distance of one (1) meter from the axis of intake.



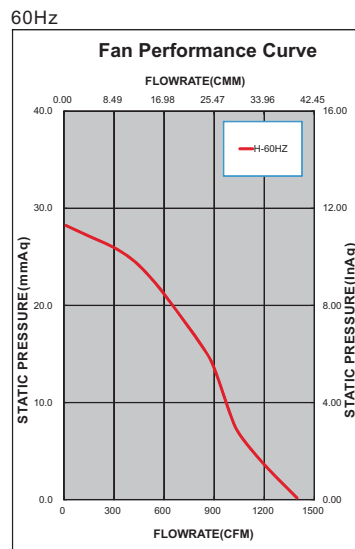
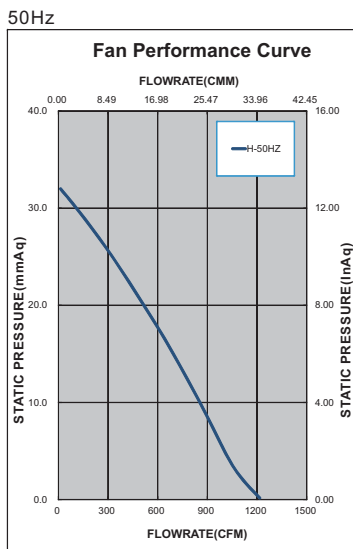

Bearing type: ◎=Ball ※=Sleeve ●=Hypro bearing

Frame size (mm)	Model No.	Bearing System Type	Volt. (VAC)	Freq. (Hz)	Current (A)	Power (W)	Rated Speed (rpm)	Maximum AirFlow	Maximum Pressure (InAq)	Maximum Pressure (mmAq)	*Noise Level (dB/A)	Weight (g)	
280x89	AK2881HB	◎	115	50/60	1.80/2.60	180.00/260.00	2800/3200	33.960/39.620	1200.0/1400.0	1.260/1.110	32.00/28.20	75.0/78.0	4240
	AK2882HB		230		0.78/1.22	177.10/260.00							

Specifications subject to change without notice.



*Safety approvals

				
✓	✓			

X-ON Electronics

Largest Supplier of Electrical and Electronic Components

Click to view similar products for [Blowers](#) category:

Click to view products by [ADDA](#) manufacturer:

Other Similar products are found below :

[G2E120-CR21-13](#) [R2D160-AC02-13](#) [R2D220-AA24-13](#) [RLF35-812N2P-103](#) [KFB1724VHT-AF00](#) [D4E133-AA01-51](#) [D4E133-DH61-D1](#)
[D4E180-BA04-18](#) [Z4.802.1680.0](#) [R3G280-AK54-01](#) [G3G120-BB13-02](#) [1398425-1](#) [R2D225-AV02-14](#) [D2E146-HT67-63](#) [BFB0524HH-R00](#)
[R3G133-AE17-02](#) [D4E225-BC01-23](#) [R3G190-AB23-02](#) [RER101-36/14N/2HHA-184](#) [G3G160-AC70-01](#) [R3G250-AM70-01](#) [R2E160-AY47-](#)
[10](#) [R2E180-AS77-40](#) [R87B-PF01](#) [R87F-A3A83H](#) [R87F-A4A15MP](#) [R87T-A6A07H](#) [MF50151VX-B00U-A99](#) [BFB0512HH-T50F](#)
[BFB0712H](#) [109BD12HA2](#) [109BD24HD2](#) [109BF12MA2](#) [109BF12MC2](#) [109BF24HA2](#) [109BF24HC2](#) [109BD12MC2](#) [109BF12HA2](#)
[109BF12HC2](#) [109BF24HD2](#) [R3G280-AF45-81](#) [BFB0724H-T500](#) [R87F-A3A15HP](#) [R87F-A4A93HP](#) [R87F-A3A93HP](#) [R2E140-AS77-05](#)
[R2E180-AS77-22](#) [R2E180-CB28-01](#) [14539GA-12N-AA-00](#) [R87F-A1A85HP](#)