



MIC912

200MHz Low-Power SOT23-5 Op Amp

General Description

The MIC912 is a high-speed, operational amplifier with a gain-bandwidth product of 200MHz. The part is unity-gain stable provided its output is loaded with at least 200 Ω . It has a very low, 2.4mA supply current, and features the tiny SOT23-5 package.

Supply voltage range is from $\pm 2.5V$ to $\pm 9V$, allowing the MIC912 to be used in low-voltage circuits or applications requiring large dynamic range.

The MIC912 is stable driving any capacitive load and achieves excellent PSRR, making it much easier to use than most conventional high-speed devices. Low supply voltage, low power consumption, and small packing make the MIC912 ideal for portable equipment. The ability to drive capacitive loads also makes it possible to drive long coaxial cables.

Data sheets and support documentation can be found on Micrel's web site at: www.micrel.com.

Features

- 200MHz gain bandwidth product
- 2.4mA supply current
- SOT23-5 package
- 360V/ μs slew rate
- Drives any capacitive load
- Unconditionally stable with gain of +2 or -1
- Conditionally stable with gain of +1

Applications

- Video
- Imaging
- Ultrasound
- Portable equipment
- Line drivers

Ordering Information

Part Number	Temperature Range	Package	Lead Finish
MIC912BM5	-40° to +85°C	5-Pin SOT23	Standard
MIC912YM5	-40° to +85°C	5-Pin SOT23	Pb-Free

Pin Configuration

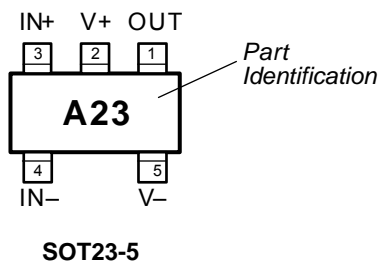

Functional Pinout

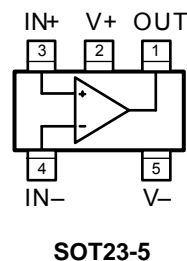

Pin Description

Pin Number	Pin Name	Pin Function
1	OUT	Output: Amplifier Output
2	V+	Positive Supply (Input)
3	IN+	Non-inverting Input
4	IN-	Inverting Input
5	V-	Negative Supply (Input)

Absolute Maximum Ratings⁽¹⁾

Supply Voltage ($V_{V+} - V_{V-}$).....	20V
Differential Input Voltage ($ V_{IN+} - V_{IN-} $) ⁽³⁾	8V
Input Common-Mode Range ($V_{IN+} - V_{IN-}$).....	V_{V+} to V_{V-}
Lead Temperature (soldering, 5 sec.).....	260°C
Storage Temperature (T_s).....	150°C
ESD Rating ⁽⁴⁾	1.5kV

Operating Ratings⁽²⁾

Supply Voltage (V_S).....	$\pm 2.5V$ to $\pm 9V$
Junction Temperature (T_J).....	$-40^\circ C$ to $+85^\circ C$
Thermal Resistance.....	260°C/W

Electrical Characteristics ($\pm 5V$)

$V_{V+} = +5V$, $V_{V-} = -5V$, $V_{CM} = 0V$, $V_{OUT} = 0V$; $R_L = 10M\Omega$; $T_J = 25^\circ C$, **bold** values indicate $-40^\circ C \leq T_J \leq +85^\circ C$; unless noted.

Symbol	Parameter	Condition	Min	Typ	Max	Units
V_{OS}	Input Offset Voltage			1	15	mV
	Input Offset Voltage Temperature Coefficient			4		$\mu V/^\circ C$
I_B	Input Bias Current			3.5	5.5	μA
					9	μA
I_{OS}	Input Offset Current			0.05	3	μA
V_{CM}	Input Common-Mode Range	CMRR > 60dB	-3.25		+3.25	V
CMRR	Common-Mode Rejection Ratio	$-2.5V < V_{CM} < +2.5V$	70	90		dB
			60			dB
PSRR	Power Supply Rejection Ratio	$\pm 5V < V_S < \pm 9V$	74	90		dB
			70			dB
A_{VOL}	Large-Signal Voltage Gain	$R_L = 2k, V_{OUT} = \pm 2V$	60	71		dB
		$R_L = 200\Omega, V_{OUT} = \pm 1V$	60	71		dB
V_{OUT}	Maximum Output Voltage Swing	positive, $R_L = 2k\Omega$	+3.3	3.5		V
			+3.0			V
		negative, $R_L = 2k\Omega$		-3.5	-3.3	V
					-3.0	V
		positive, $R_L = 200\Omega$	+3.0	3.2		V
			+2.75			V
		negative, $R_L = 200\Omega$		-2.8	-2.45	V
					-2.2	V
GBW	Unity Gain-Bandwidth Product	$R_L = 1k\Omega$		170		MHz
BW	-3dB Bandwidth	$A_V = 1, R_L = 100\Omega$		150		MHz
SR	Slew Rate			325		V/ μs
I_{GND}	Short-Circuit Output Current	source		72		mA
		sink		25		mA
	Supply Current			2.4	3.5	mA
					4.1	mA

Electrical Characteristics

$V_{V+} = +9V$, $V_{V-} = -9V$, $V_{CM} = 0V$, $V_{OUT} = 0V$; $R_L = 10M\Omega$; $T_J = 25^\circ C$, **bold** values indicate $-40^\circ C \leq T_J \leq +85^\circ C$; unless noted.

Symbol	Parameter	Condition	Min	Typ	Max	Units
V_{OS}	Input Offset Voltage			1	15	mV
	Input Offset Voltage Temperature Coefficient			4		$\mu V/^\circ C$
I_B	Input Bias Current			3.5	5.5	μA
					9	μA
I_{OS}	Input Offset Current			0.05	3	μA
V_{CM}	Input Common-Mode Range	CMRR > 60dB	-7.25		+7.25	V
CMRR	Common-Mode Rejection Ratio	$-6.5V < V_{CM} < 6.5V$	70	98		dB
			60			dB
A_{VOL}	Large-Signal Voltage Gain	$R_L = 2k\Omega$, $V_{OUT} = \pm 6V$	60	73		dB
V_{OUT}	Maximum Output Voltage Swing	positive, $R_L = 2k\Omega$	+7.2	+7.4		V
			+6.8			V
		negative, $R_L = 2k\Omega$		-7.4	-7.2	V
					-6.8	V
GBW	Unity Gain-Bandwidth Product	$R_L = 1k\Omega$		200		MHz
SR	Slew Rate			360		V/ μs
I_{GND}	Short-Circuit Output Current	source		90		mA
		sink		32		mA
	Supply Current			2.5	3.7	mA
					4.3	mA

Notes:

1. Exceeding the absolute maximum rating may damage the device.
2. The device is not guaranteed to function outside its operating rating.
3. Exceeding the maximum differential input voltage will damage the input stage and degrade performance (in particular, input bias current is likely to change).
4. Devices are ESD sensitive. Handling precautions recommended. Human body model, 1.5k in series with 100pF.

Test Circuits

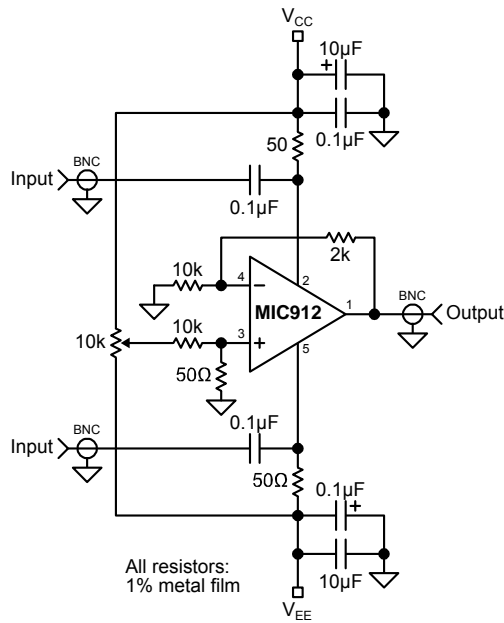

PSRR vs. Frequency

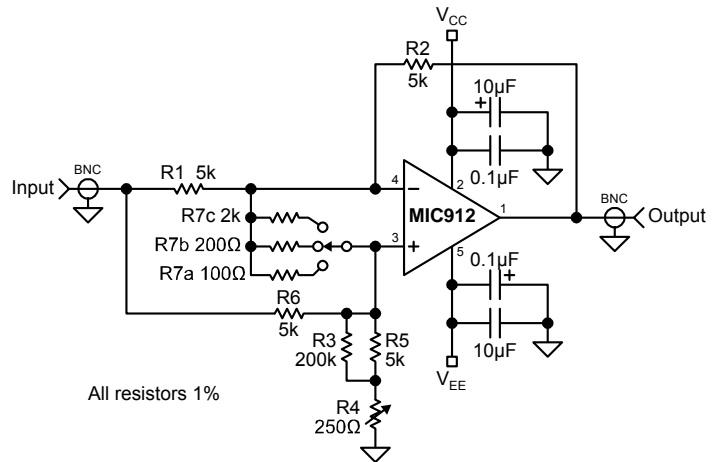

$$V_{OUT} = V_{ERROR} \left(1 + \frac{R2}{R1} + \frac{R2 + R5 + R4}{R7} \right)$$

CMRR vs. Frequency

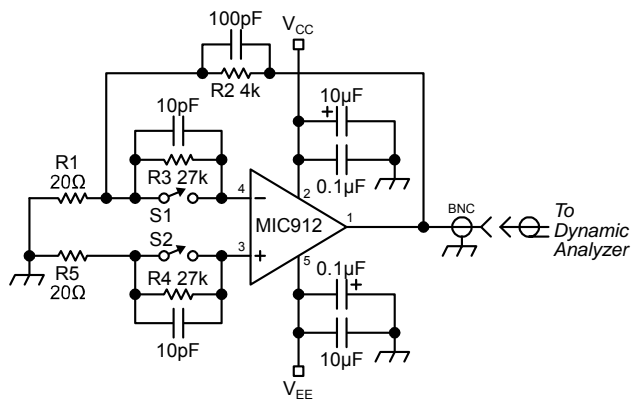

Noise Measurement

Typical Characteristics

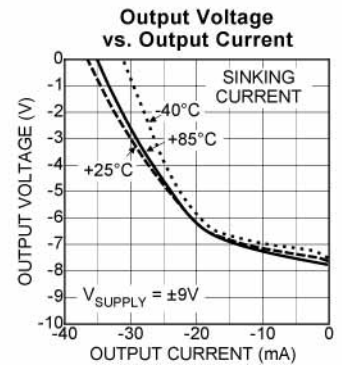
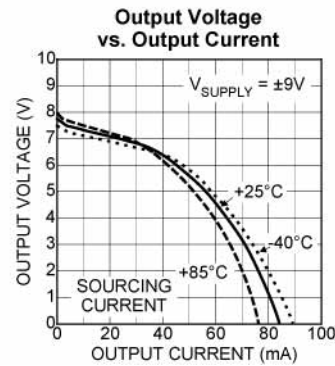
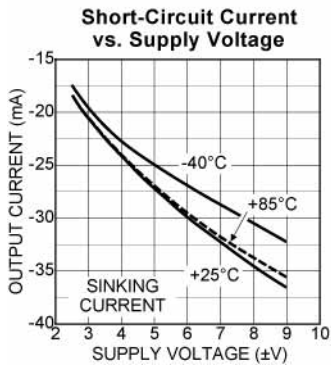
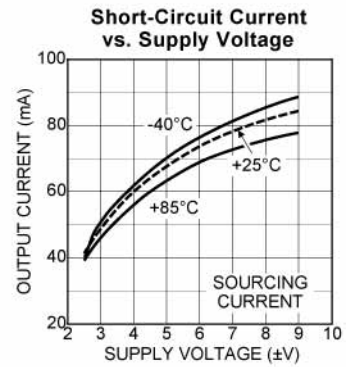
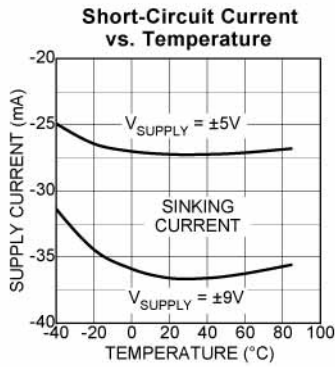
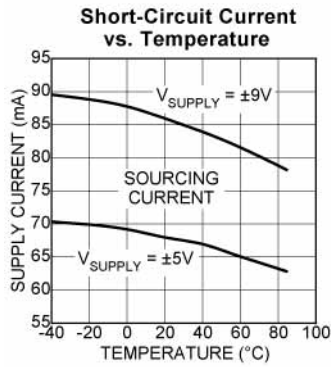
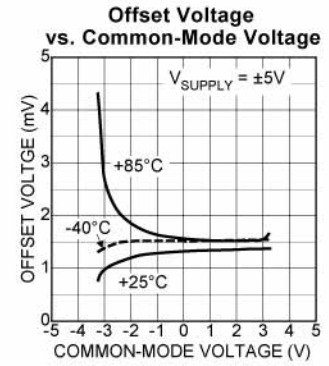
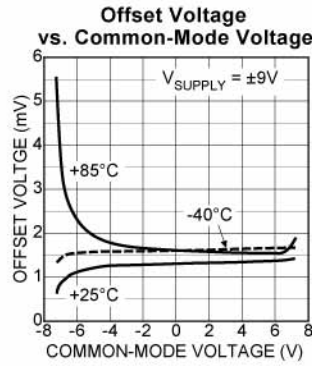
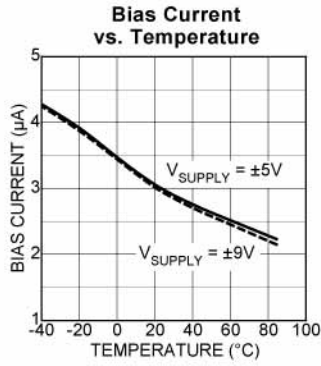
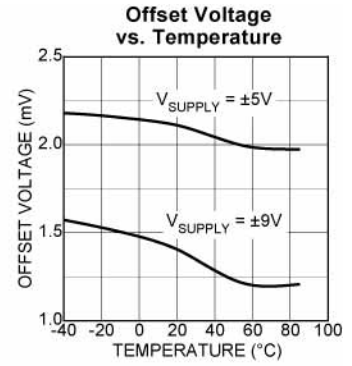
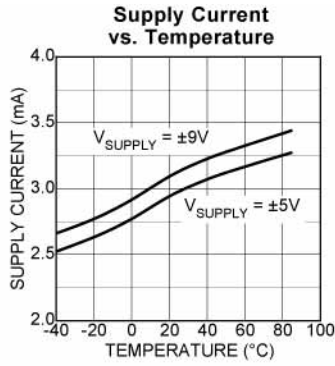
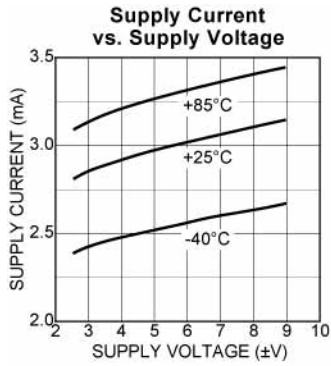

Typical Characteristics (continued)

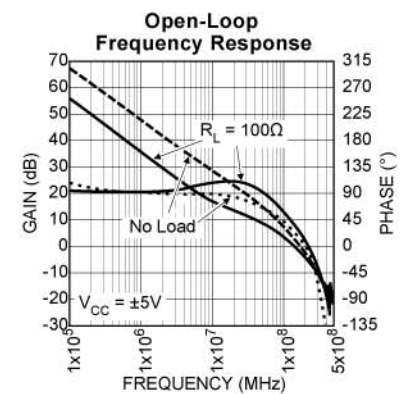
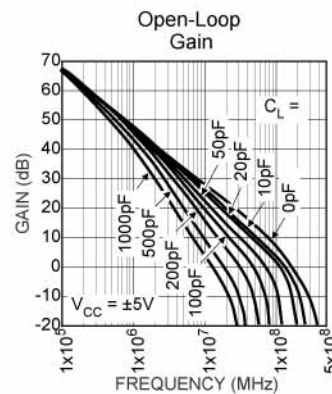
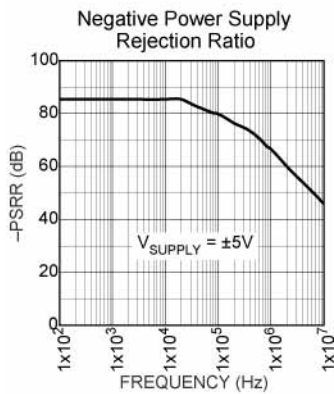
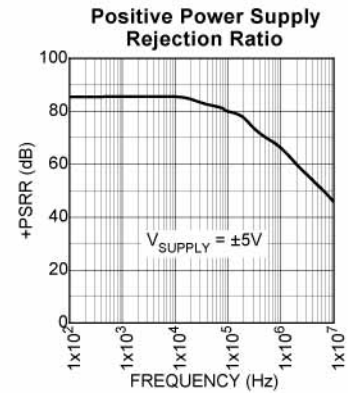
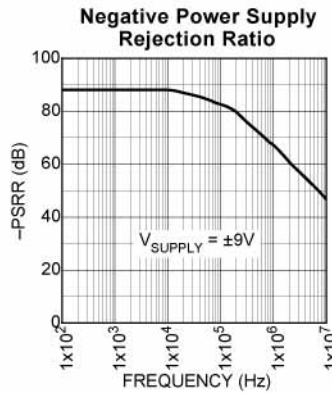
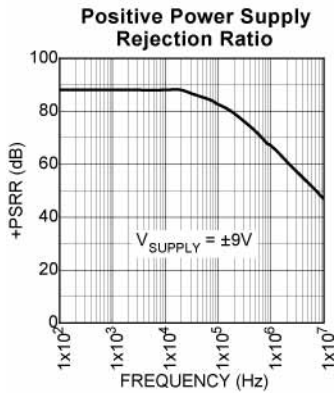
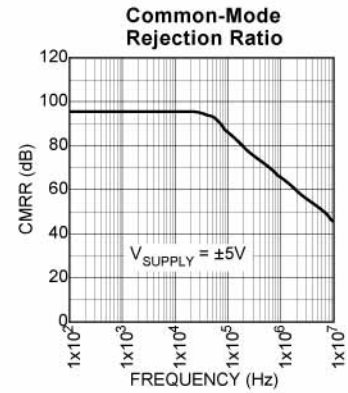
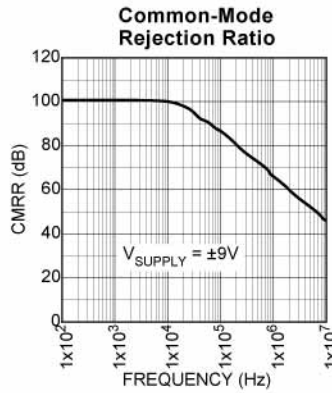
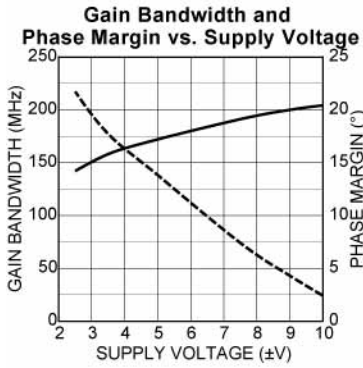
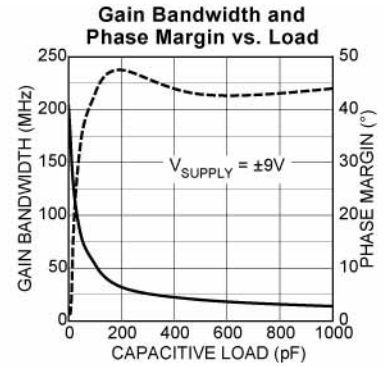
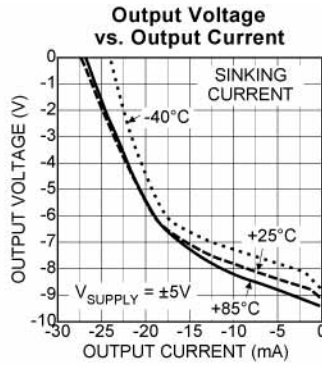
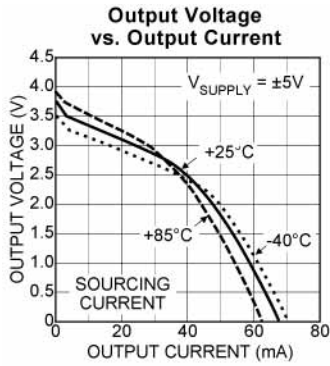

Typical Characteristics (continued)

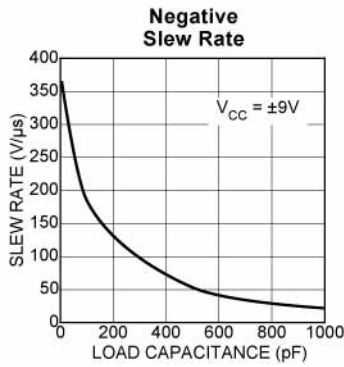
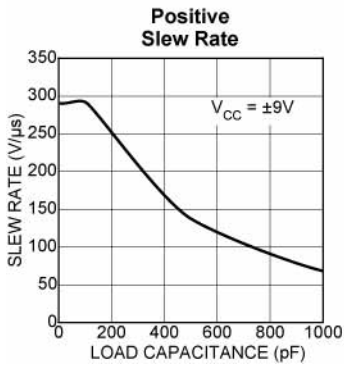
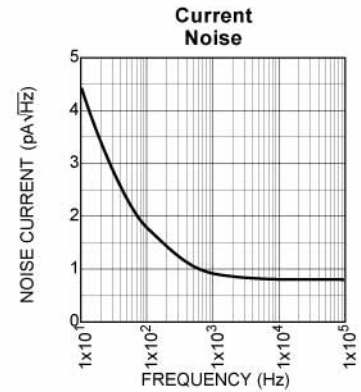
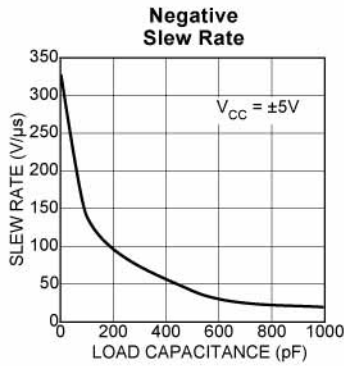
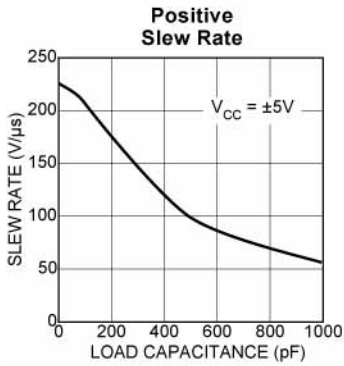
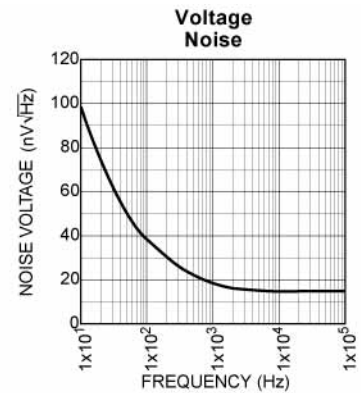
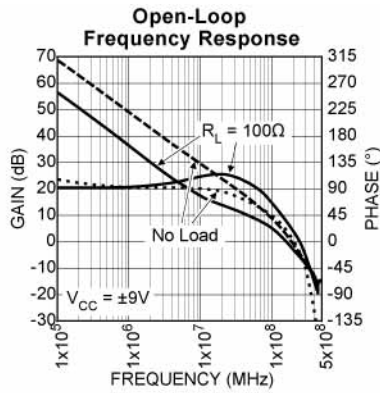
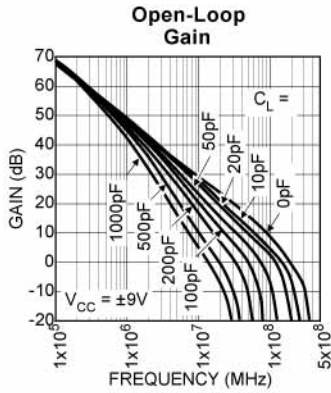

Functional Characteristics

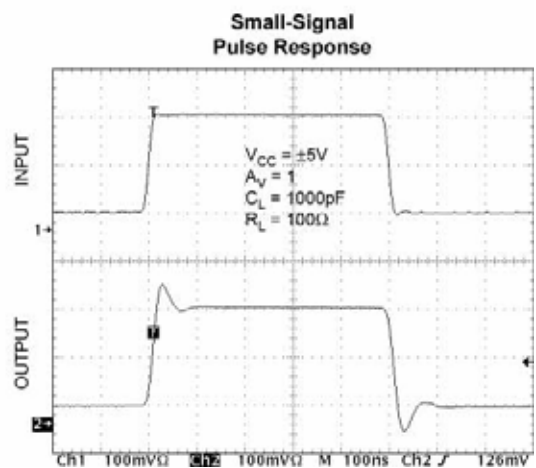
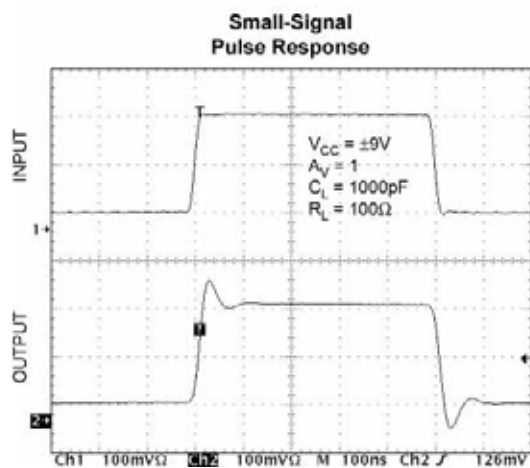
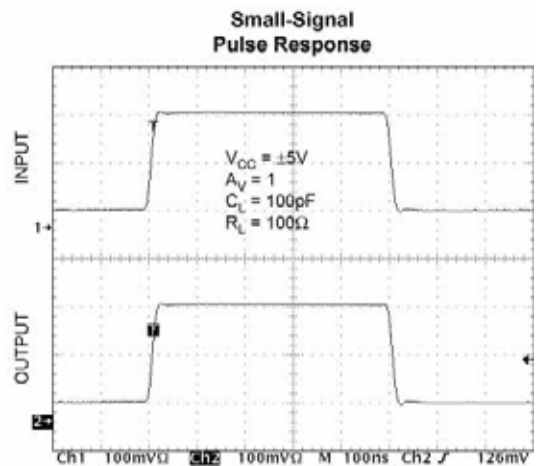
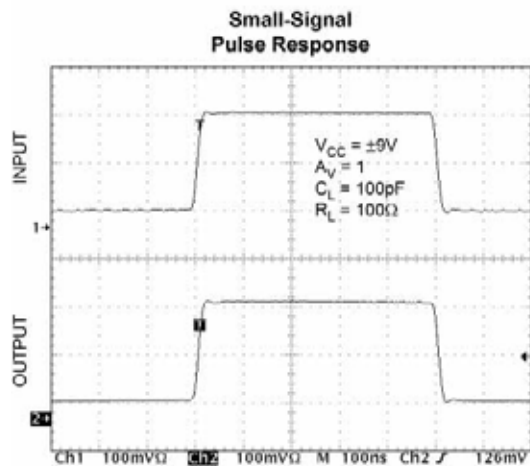
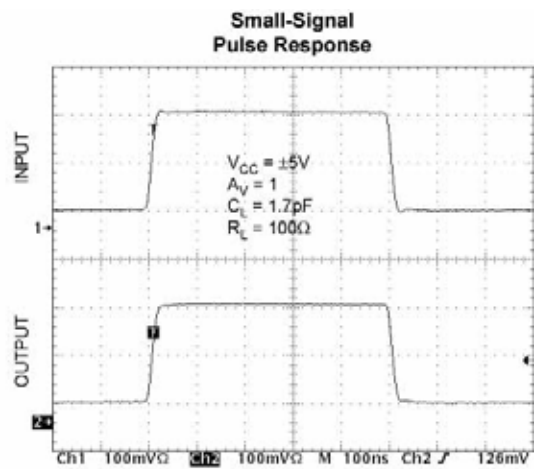
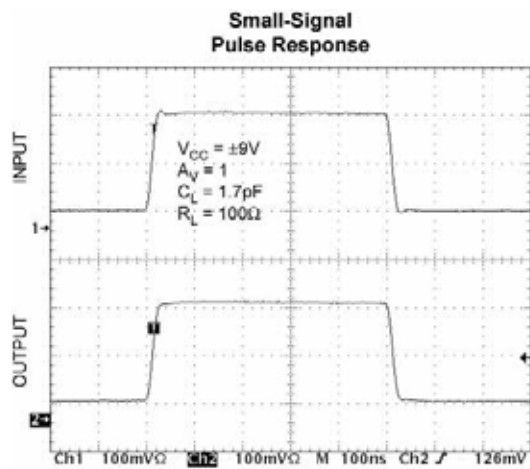

Functional Characteristics (continued)

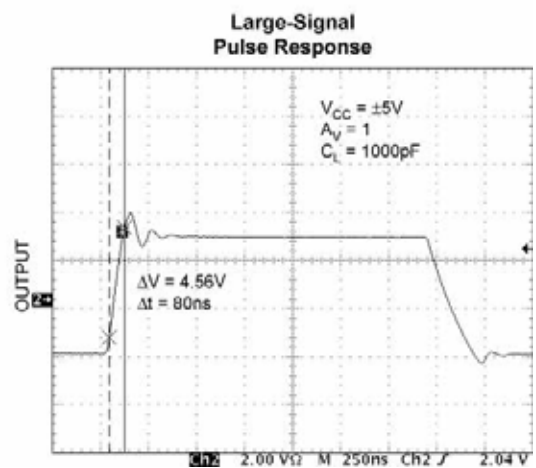
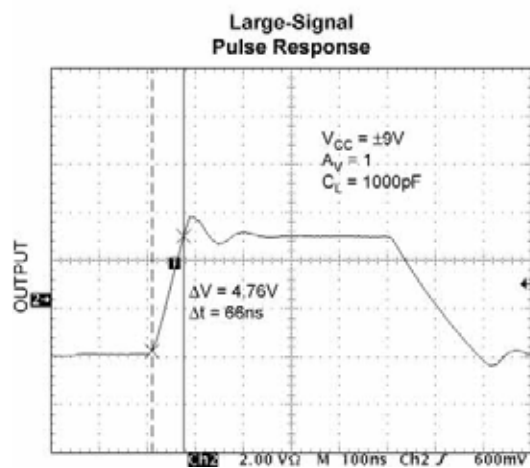
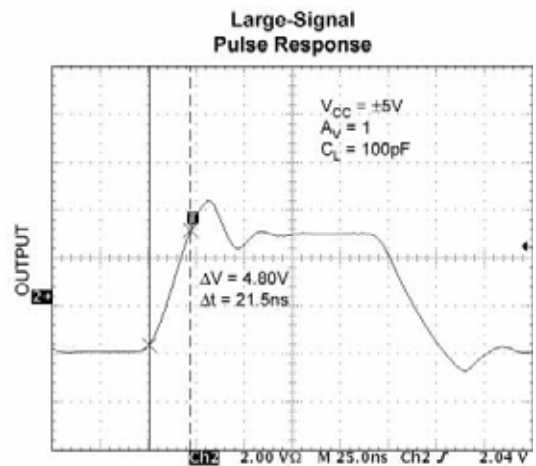
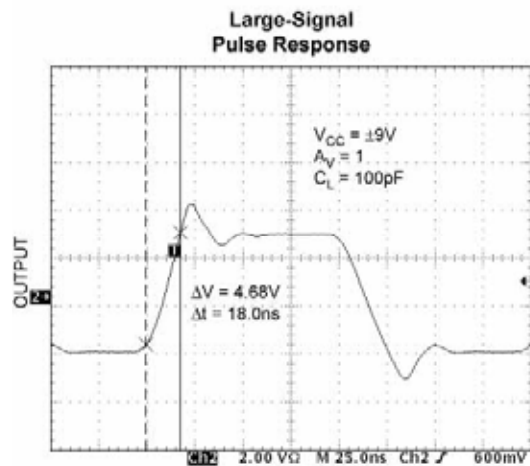
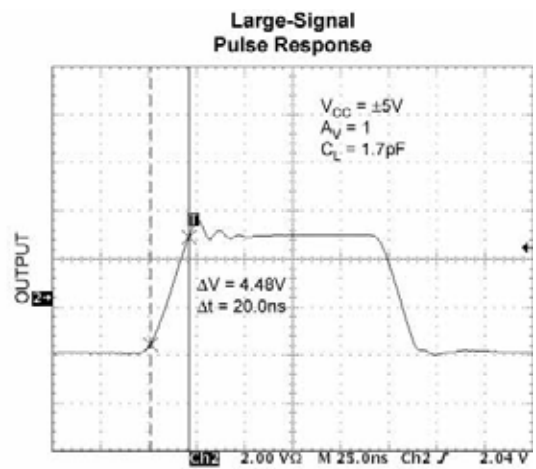
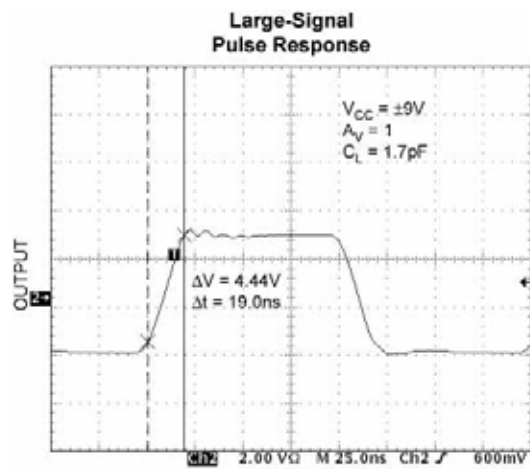

Application Information

The MIC912 is a high-speed, voltage-feedback operational amplifier featuring very low supply current and excellent stability. This device is unity gain stable with $R_L \leq 200\Omega$ and capable of driving high capacitance loads.

Stability Considerations

The MIC912 is unity gain stable and it is capable of driving unlimited capacitance loads, but some design considerations are required to ensure stability. ***The output needs to be loaded with 200Ω resistance or less and/or have sufficient load capacitance to achieve stability (refer to the “Load Capacitance vs. Phase Margin” graph).***

For applications requiring a little less speed, Micrel offers the MIC910, a more heavily compensated version of the MIC912 which provides extremely stable operation for all load resistance and capacitance.

Driving High Capacitance

The MIC912 is stable when driving high capacitance (see “Typical Characteristics: Gain Bandwidth and Phase Margin vs. Load Capacitance”) making it ideal for driving long coaxial cables or other high-capacitance loads.

Phase margin remains constant as load capacitance is increased. Most high-speed op amps are only able to drive limited capacitance.

Note: increasing load capacitance does reduce the speed of the device (see “Typical Characteristics: Gain Bandwidth and Phase Margin vs. Load”). In applications where the load capacitance reduces the speed of the op amp to an unacceptable level, the effect of the load capacitance can be reduced by adding a small resistor (<100Ω) in series with the output.

Feedback Resistor Selection

Conventional op amp gain configurations and resistor selection apply, the MIC912 is NOT a current feedback device. Resistor values in the range of 1k to 10k are recommended.

Layout Considerations

All high speed devices require careful PCB layout. The following guidelines should be observed: Capacitance, particularly on the two inputs pins will degrade performance; avoid large copper traces to the inputs. Keep the output signal away from the inputs and use a ground plane.

It is important to ensure adequate supply bypassing capacitors are located close to the device.

Power Supply Bypassing

Regular supply bypassing techniques are recommended. A 10μF capacitor in parallel with a 0.1μF capacitor on both the positive and negative supplies are ideal. For best performance all bypassing capacitors should be located as close to the op amp as possible and all capacitors should be low ESL (equivalent series inductance), ESR (equivalent series resistance). Surface-mount ceramic capacitors are ideal.

Thermal Considerations

The SOT23-5 package, like all small packages, has a high thermal resistance. It is important to ensure the IC does not exceed the maximum operating junction (die) temperature of 85°C. The part can be operated up to the absolute maximum temperature rating of 125°C, but between 85°C and 125°C performance will degrade, in particular CMRR will reduce.

A MIC912 with no load, dissipates power equal to the quiescent supply current * supply voltage.

$$P_{D(\text{no load})} = (V_{V+} - V_{V-})I_S$$

When a load is added, the additional power is dissipated in the output stage of the op amp. The power dissipated in the device is a function of supply voltage, output voltage and output current.

$$P_{D(\text{output stage})} = (V_{V+} - V_{V-})I_{OUT}$$

$$\text{Total Power Dissipation} = P_{D(\text{no load})} + P_{D(\text{output stage})}$$

Ensure the total power dissipated in the device is no greater than the thermal capacity of the package. The SOT23-5 package has a thermal resistance of 260°C/W.

$$\text{Max. Allowable Power Dissipation} = \frac{T_{J(\text{max})} - T_{A(\text{max})}}{260W}$$

Package Information

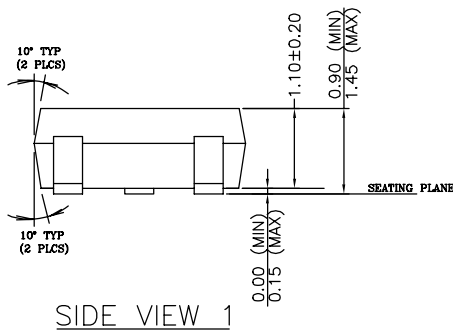
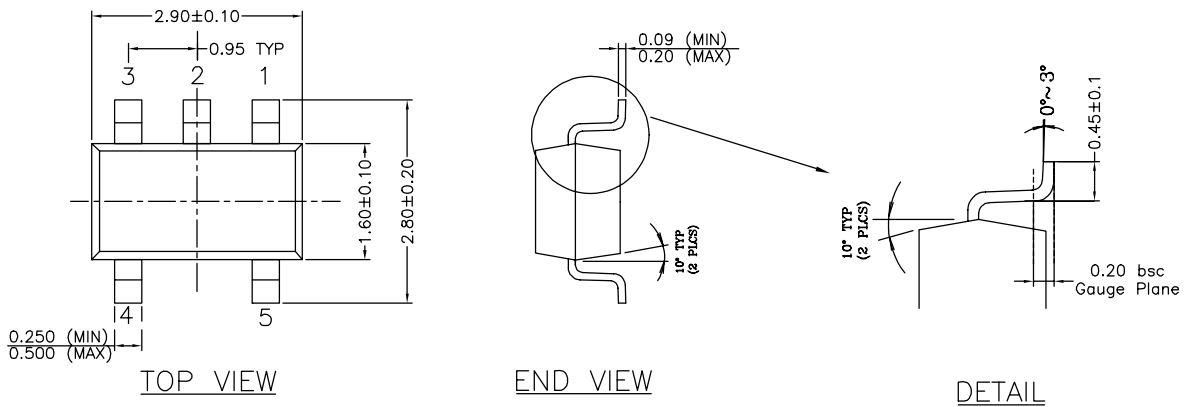

- NOTE:
1. PACKAGE OUTLINE EXCLUSIVE OF MOLD FLASH & BURR.
 2. PACKAGE OUTLINE INCLUSIVE OF SOLER PLATING.
 3. DIMENSION AND TOLERANCE PER ANSI Y14.5M, 1982.
 4. FOOT LENGTH MEASUREMENT BASED ON GAUGE PLANE METHOD.
 5. DIE FACES UP FOR MOLD, AND FACES DOWN FOR TRIM/FORM.
 6. ALL DIMENSIONS ARE IN MILLIMETERS.

5-Pin SOT23 (M5)

MICREL, INC. 2180 FORTUNE DRIVE SAN JOSE, CA 95131 USA
 TEL +1 (408) 944-0800 FAX +1 (408) 474-1000 WEB <http://www.micrel.com>

The information furnished by Micrel in this data sheet is believed to be accurate and reliable. However, no responsibility is assumed by Micrel for its use. Micrel reserves the right to change circuitry and specifications at any time without notification to the customer.

Micrel Products are not designed or authorized for use as components in life support appliances, devices or systems where malfunction of a product can reasonably be expected to result in personal injury. Life support devices or systems are devices or systems that (a) are intended for surgical implant into the body or (b) support or sustain life, and whose failure to perform can be reasonably expected to result in a significant injury to the user. A Purchaser's use or sale of Micrel Products for use in life support appliances, devices or systems is a Purchaser's own risk and Purchaser agrees to fully indemnify Micrel for any damages resulting from such use or sale.

© 2001 Micrel, Incorporated.

X-ON Electronics

Largest Supplier of Electrical and Electronic Components

Click to view similar products for [Operational Amplifiers - Op Amps](#) category:

Click to view products by [Microchip](#) manufacturer:

Other Similar products are found below :

[OPA2991IDSGR](#) [OPA607IDCKT](#) [007614D](#) [633773R](#) [635798C](#) [635801A](#) [702115D](#) [709228FB](#) [741528D](#) [NCV33072ADR2G](#)
[SC2902DTBR2G](#) [SC2903DR2G](#) [SC2903VDR2G](#) [LM258AYDT](#) [LM358SNG](#) [430227FB](#) [430228DB](#) [460932C](#) [AZV831KTR-G1](#) [409256CB](#)
[430232AB](#) [LM2904DR2GH](#) [LM358YDT](#) [LT1678IS8](#) [042225DB](#) [058184EB](#) [070530X](#) [SC224DR2G](#) [SC239DR2G](#) [SC2902DG](#)
[SCYA5230DR2G](#) [714228XB](#) [714846BB](#) [873836HB](#) [MIC918YC5-TR](#) [TS912BIYDT](#) [NCS2004MUTAG](#) [NCV33202DMR2G](#)
[M38510/13101BPA](#) [NTE925](#) [SC2904DR2G](#) [SC358DR2G](#) [LM358EDR2G](#) [AZV358MTR-G1](#) [AP4310AUMTR-AG1](#) [HA1630D02MMEL-E](#)
[NJM358CG-TE2](#) [HA1630S01LPEL-E](#) [LM324AWPT](#) [HA1630Q06TELL-E](#)