



*MP Series modular sensors enable users to customize a sensing solution for almost any application. For this reason, the components of this series are sold separately. Refer to pages 594-595 for instruction on how to assemble an MP Series sensor.*

## MP Series Modular Photoelectric Sensors

- Harsh Duty
- Modular design
  - Exchangeable rotatable heads
  - Limit switch and mini style plug-in bases
  - Screw terminal, preleaded, and connector version receptacles
- Withstands 1200 psi washdown, IP69K
- 6 A SPDT and 5 A DPDT relay models
- Multifunction timer/logic cards available
- DC, AC, AC/DC models



### Diffuse Mode

**Sensing Ranges:** 300 mm, 450 mm, 760 mm, 900 mm, 1.3 m, 1.8 m, 3 m

**Outputs:** Dependent on base selected

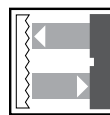

### Retro-Reflective Mode

**Features:**

- Polarization filter to detect shiny objects

**Sensing Ranges:** 4.5 m, 6 m, 9 m

**Outputs:** Dependent on base selected

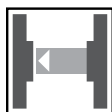

### Thru-Beam Mode

**Sensing Ranges:** 36 m, 60 m

**Outputs:** Dependent on base selected

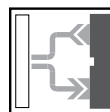

### Fiber Optic Mode

**Sensing Ranges:** Dependent on fibers selected

**Outputs:** Dependent on base selected

See page 610-620 for MP Series sensing characteristics, wiring, dimensions and accessories.



STANDARD HEADS (pages 596-597)		Models
	Diffuse: 450 mm range, 1 ms response, plastic lens, infrared	MPD6HD ⚡
	Diffuse: 3 m range, 10 ms response, glass lens, infrared	MPD1HD •
	Diffuse: 3 m range, 10 ms response, plastic lens, infrared	MPD2HD ⚡
	Diffuse: 900 mm range, 10 ms response, plastic lens, infrared	MPD4HD ⚡
	Diffuse: 1.3 m range, 10 ms response, plastic lens, infrared	MPD8HD
	Polarized Retro-Reflective: 4.5 m range, 1 ms response, glass lens, visible red	MPP6HD ⚡
	Polarized Retro-Reflective: 6 m range, 10 ms response, glass lens, visible red	MPP1HD •
	Retro-Reflective: 9 m range, 1 ms response, glass lens, infrared	MPL16HD
	Retro-Reflective: 9 m range, 1 ms response, plastic lens, infrared	MPL6HD •
	Retro-Reflective: 9 m range, 10 ms response, glass lens, infrared	MPL1HD
	Retro-Reflective: 9 m range, 10 ms response, plastic lens, infrared	MPL2HD ⚡
	Thru-Beam: 60 m range, transmitter, glass lens, infrared	MPE1HD •
	Thru-Beam: 60 m range, transmitter, plastic lens, infrared	MPE2HD ⚡
	Thru-Beam: 60 m range, receiver, 1 ms response, glass lens, infrared	MPR16HD
	Thru-Beam: 60 m range, receiver, 1 ms response, plastic lens, infrared	MPR6HD ⚡
	Thru-Beam: 60 m range, receiver, 10 ms response, glass lens, infrared	MPR1HD •
	MPF Fiber Optic: 1 ms response, infrared	MPF6HD ⚡
	MPF Fiber Optic: 5 ms response, visible red	MPF2HD
	MPG Fiber Optic: 1 ms response, infrared	MPG6HD •

ANALOG HEADS (page 598)		Models
	MPF Fiber Optic: infrared	MPF5HD

2-WIRE AC HEADS (pages 598-600)		Models
	Diffuse: 300 mm range, plastic lens, infrared	MP2D7HD
	Diffuse: 760 mm range, plastic lens, infrared	MP2D4HD ⚡
	Diffuse: 1.8 m range, glass lens, infrared	MP2D1HD
	Diffuse: 1.8 m range, plastic lens, infrared	MP2D2HD •
	Polarized Retroreflective: 4.5 m range, glass lens, visible red	MP2P1HD
	Retroreflective: 9 m range, glass lens, infrared	MP2L1HD
	Retroreflective: 9 m range, plastic lens, infrared	MP2L2HD ⚡
	Thru-Beam: 36 m range, transmitter, glass lens, infrared	MPE3HD
	Thru-Beam: 36 m range, transmitter, plastic lens, infrared	MPE4HD
	Thru-Beam: 36 m range, receiver, plastic lens, infrared	MP2R2HD
	MPF Fiber Optic: infrared	MP2F1HD
	MPF Fiber Optic: visible red	MP2F2HD

## 2. SELECT A BASE

## 3. SELECT A RECEPTACLE

PLUG-IN BASES (pages 602-603)		Models
AC/DC	10.8-140 VDC/18-140 VAC 4-wire FET w/output indicator	MPS18HD ⚡
DC	10-30 VDC emitter base only	MPS30HD
	10-30 VDC NPN and PNP, 4-wire DC	MPS33HD ⚡
	10-30 VDC NPN N.O./N.C., 4-wire DC	MPS31HD ●
	10-30 VDC PNP, 3-wire DC	MPS32HD ●
AC	198-264 VAC 4-wire solid state AC relay 1 A max.	MPS12HD
	198-264 VAC emitter base only	MPS13HD
	92-132 VAC 4-wire bilateral FET (AC/DC) 100 mA max.	MPS17HD ●
	92-132 VAC 4-wire solid state AC relay 1 A max.	MPS11HD ⚡
	92-132 VAC emitter base only	MPS10HD ●

RECEPTACLE	Models
Standard 4-terminal, 1/2" NPT conduit thread	MPB20 ⚡
5-pin mini connector	MPB22 ●
4-pin micro connector	MPB27 ○

AC DPDT RELAY BASE (page 603)		Model
RELAY	DPDT, 92-132 VAC, 5 A, output indicator	MPSD11HD ⚡

DPDT RECEPTACLE	Models
8-terminal, 1/2" NPT conduit hole	MPB23 ●
8-terminal, 3/4" NPT conduit hole	MPB24

SPDT RELAY BASES (page 604)		Models
DC	SPDT, 10-30 VDC, 6 A	MPV31HD ●
SPDT RELAY AC	SPDT, 103-132 VAC, 6 A	MPV11HD
	SPDT, 192-264 VAC, 6 A	MPV12HD
	SPDT, 20-260 VAC/VDC, 6 A	MPV14HD ●
	SPDT, 22-26 VAC, 6 A	MPV13HD

**NO RECEPTACLE NEEDED**

MINI STYLE BASES (pages 605-607)		Models
3-WIRE DC	10-30 VDC, 2 m preleaded cable, emitter base only	▲ MPT30HD
	10-30 VDC, NPN N.O., 2 m preleaded cable	▲ MPT31HD ●
	10-30 VDC, PNP N.O., 2 m preleaded cable	▲ MPT32HD
	10-30 VDC, NPN and PNP, N.O., 2 m preleaded cable	▲ MPT33HD ⚡
4-WIRE AC	92-132VAC, 2m preleaded cable, emitter base only	▲ MPT10HD
	92-132 VAC, 4-wire bilateral FET (AC/DC), 100 mA max., 2 m preleaded cable	▲ MPT17HD
	92-132 VAC, 4-wire solid state AC relay, 0.5 A max., 2 m preleaded cable	▲ MPT11HD
AC/DC	22-26 VAC/VDC, 4-wire bilateral FET, 100 mA max., 2 m preleaded cable	▲ MPT16HD ●
MICRO CONNECT. DC	10-30 VDC, NPN N.O., 4-pin micro connector	○ MPT41HD-CM
	10-30 VDC, PNP N.O., 4-pin micro connector	○ MPT42HD-CM ●
	10-30 VDC, NPN and PNP, N.O., 4-pin micro connector	○ MPT43HD-CM ⚡
	10-30 VDC, 4-pin micro connector, emitter base only	○ MPT40HD-CM
MINI CONNECT. DC	10-30 VDC, NPN and PNP, 4-pin mini connector	● MPT43HD ⚡
	10-30 VDC, NPN N.O., 4-pin mini connector	● MPT41HD
	10-30 VDC, PNP N.O., 4-pin mini connector	● MPT42HD ●
MINI CONNECT. AC	92-132 VAC, 3-pin mini connector, emitter base only	● MPT20HD
	92-132 VAC, 4-wire solid state AC relay, 0.5 A max., 5-pin mini connector	● MPT21HD ●
	92-132 VAC, 4-wire bilateral FET (AC/DC), 100 mA max., 5-pin mini connector	● MPT27HD ●
MINI AC/DC	10.8-140 VDC/18-140 VAC, 4-wire FET w/output ind., 5-pin mini connector	● MPT28HD
MINI RELAY AC	92-132 VAC, 6 A, SPDT relay, 2 m preleaded cable	▲ MPW11HD ●
	92-132 VAC, 6 A, SPDT relay, 5-pin mini connector	● MPW21HD

### ELECTRICAL CONNECTION KEY

■	Terminal connectors
●	Mini connectors
○	Micro connectors
▲	Preleaded cable

**NO RECEPTACLE NEEDED**

ANALOG PLUG-IN BASE (page 608)		Model
ANALOG	12-24 VDC analog output (0-5 VDC or 4-20 mA)	MPS35HD

RECEPTACLE	Models
Standard 4-terminal, 1/2" NPT conduit thread	MPB20 ⚡
5-pin mini connector	MPB22 ●

2-WIRE PLUG-IN BASES (page 609)		Models
DC	10-30 VDC emitter base only	MPS30HD
2-WIRE AC	92-132 VAC emitter base only	MPS10HD ●
	198-264 VAC emitter base only	MPS13HD
	22-26 VAC/VDC emitter base only	MPS14HD
	22-260 VAC plug-in base	MP2S11HD ⚡

- ⚡ Stocked item
  - Typical delivery 4 weeks or less
- Consult factory for all other models

## STANDARD HEADS

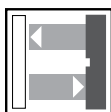

### Diffuse Mode

Specifications	Infrared			
	450 mm	900 mm	1.3 m	3 m
SENSING RANGE	450 mm	900 mm	1.3 m	3 m
SENSITIVITY ADJUSTMENT	Yes	Yes	Yes	Yes
MODEL NUMBER(S)	MPD6HD	MPD4HD	MPD8HD	MPD1HD
	—	—	—	MPD2HD
RESPONSE TIME*	≤ 1 ms	≤ 10 ms	≤ 10 ms	≤ 10 ms
HOUSING MATERIAL	Polycarbonate	Polycarbonate	Polycarbonate	Polycarbonate
	LENS Plastic	Plastic	Plastic	Glass (1HD)/plastic (2HD)
ADDITIONAL DATA	<i>See page 601</i>			

\*NOTE: Total response time is the sum of the sensor head and base response times.

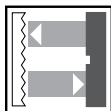

### Retro-Reflective Mode

Specifications	Visible Red		Infrared	
	4.5 m	6 m	9 m	9 m
SENSING RANGE	4.5 m	6 m	9 m	9 m
SENSITIVITY ADJUSTMENT	Yes	Yes	Yes	Yes
POLARIZED FILTER	Yes	Yes	No	No
MODEL NUMBER(S)	MPP6HD	MPP1HD	MPL1HD	MPL16HD
	—	—	MPL2HD	MPL6HD
RESPONSE TIME*	≤ 1 ms	≤ 10 ms	≤ 10 ms	≤ 1 ms
HOUSING MATERIAL	Polycarbonate	Polycarbonate	Polycarbonate	Polycarbonate
	LENS Glass	Glass	Glass (1HD)/plastic (2HD)	Glass (16HD)/plastic (6HD)
ADDITIONAL DATA	<i>See page 601</i>			

\*NOTE: Total response time is the sum of the sensor head and base response times.

**STANDARD HEADS**



**Thru-Beam Mode**

Specifications		Infrared		
SENSING RANGE		60 m	60 m	60 m
SENSITIVITY ADJUSTMENT		Yes	Yes	Yes
MODEL NUMBER(S)	Transmitter	MPE1HD	MPE1HD	MPE2HD
	Receiver	MPR1HD	MPR16HD	MPR6HD
RESPONSE TIME*		≤ 10 ms	≤ 1 ms	≤ 1 ms
HOUSING MATERIAL		Polycarbonate	Polycarbonate	Polycarbonate
	LENS	Glass	Glass	Plastic
ADDITIONAL DATA		<i>See page 601</i>		

\*NOTE: Total response time is the sum of the sensor head and base response times.

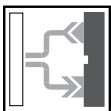

**Fiber Optic Mode**

Specifications		Visible Red	Infrared
SENSING RANGE		Determined by cable†	Determined by cable†
SENSITIVITY ADJUSTMENT		Yes	Yes
MODEL NUMBER(S)		MPF2HD	MPF6HD
		—	MPG6HD
RESPONSE TIME*		≤ 5 ms	≤ 1 ms
HOUSING MATERIAL		Polycarbonate	Polycarbonate
ADDITIONAL DATA		<i>See page 601</i>	

\*NOTE: Total response time is the sum of the sensor head and base response times.



†See pages 761-796 for fiber optic lengths and specifications.

**ANALOG HEADS**

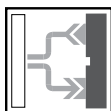

**Fiber Optic Mode**

Specifications	Infrared
SENSING RANGE	Determined by cable†
SENSITIVITY ADJUSTMENT	Yes
MODEL NUMBER(S)	MPF5HD
RESPONSE TIME	≤ 10 ms
HOUSING MATERIAL	Polycarbonate
ADDITIONAL DATA	See page 601



†See pages 761-796 for fiber optic lengths and specifications.

**2-WIRE AC HEADS**

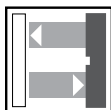

**Diffuse Mode**

Specifications	Infrared		
SENSING RANGE	300 mm	760 mm	1.8 m
SENSITIVITY ADJUSTMENT	Yes	Yes	Yes
MODEL NUMBER(S)	MP2D7HD	MP2D4HD	MP2D1HD
	—	—	MP2D2HD
RESPONSE TIME*	≤ 10 ms	≤ 15 ms	≤ 15 ms
HOUSING MATERIAL	Polycarbonate	Polycarbonate	Polycarbonate
	LENS Plastic	Plastic	Glass (1HD)/plastic (2HD)
ADDITIONAL DATA	See page 601		

\*NOTE: Total response time is the sum of the sensor head and base response times.

## 2-WIRE AC HEADS

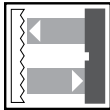

### Retro-Reflective Mode

Specifications	Visible Red	Infrared
<b>SENSING RANGE</b>	<b>4.5 m</b>	<b>9 m</b>
<b>SENSITIVITY ADJUSTMENT</b>	Yes	Yes
<b>POLARIZED FILTER</b>	Yes	No
<b>MODEL NUMBER(S)</b>	<b>MP2P1HD</b>	<b>MP2L1HD</b>
	—	<b>MP2L2HD</b>
<b>RESPONSE TIME*</b>	≤ 10 ms	≤ 10 ms
<b>HOUSING MATERIAL</b>	Polycarbonate	Polycarbonate
	<i>LENS</i> Glass	Glass (1HD)/plastic (2HD)
<b>ADDITIONAL DATA</b>	<b>See page 601</b>	

\*NOTE: Total response time is the sum of the sensor head and base response times.



### Thru-Beam Mode

Specifications	Infrared
<b>SENSING RANGE</b>	36 m
<b>SENSITIVITY ADJUSTMENT</b>	Yes
<b>MODEL NUMBER(S)</b>	<b>MPE3HD</b>
	<b>MPE4HD</b>
	<b>MP2R2HD</b>
<b>RESPONSE TIME*</b>	≤ 10 ms
<b>HOUSING MATERIAL</b>	Polycarbonate
	<i>LENS</i> Glass (3HD) Plastic (4HD/2HD)
<b>ADDITIONAL DATA</b>	<b>See page 601</b>

\*NOTE: Total response time is the sum of the sensor head and base response times.

2-WIRE AC HEADS

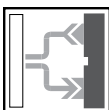

Fiber Optic Mode

Specifications	Visible Red	Infrared
SENSING RANGE	Determined by cable <sup>†</sup>	Determined by cable <sup>†</sup>
SENSITIVITY ADJUSTMENT	Yes	Yes
MODEL NUMBER(S)	MP2F2HD	MP2F1HD
RESPONSE TIME*	≤1 ms	≤1 ms
HOUSING MATERIAL	Polycarbonate	Polycarbonate
ADDITIONAL DATA	<i>See page 601</i>	

\*NOTE: Total response time is the sum of the sensor head and base response times.



<sup>†</sup>See pages 761-796 for fiber optic lengths and specifications.





## MP Series Head Specifications

MP Series Head Specifications		
LED(s)	Yes (2)	
OPERATING MODE	Light on/dark on	
PROTECTION (IEC)	IP69K when all components are properly assembled	
TEMPERATURE RANGE	WORKING	-22 °F to +158 °F
	STORAGE	-67 °F to +185 °F
HUMIDITY RANGE	95% RH (non-condensing)	
VIBRATION	10 G, 10-500 Hz	
SHOCK	50 G	
HEAD HOUSING	Glass-filled polycarbonate	
ACCESS COVER	Glass-filled acetal, Type 20	
SEALS	Santoprene	
STANDARDS	EN 60947-5-2	
APPROVALS		

Reference Guide	
SENSING CHARACTERISTICS	Pages 610-612
WIRING DIAGRAMS	Pages 613-614
DIMENSIONS	Page 615
ACCESSORIES	Pages 616-619

## Operating/Adjustment Of All Heads

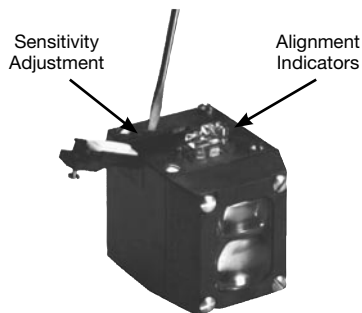

### Light On/Dark On Mode Selector Switch

Every MP Series photoelectric sensor head has a light on/dark on selector switch located on the PC board inside the sensor head. The operating mode should be set prior to assembling the head to its respective base.

**Dark On** - The output (load) is energized when the light is blocked (retro and thru scan), or object absent (diffuse scan); the photosensor is dark.

**Light On** - The output (load) is energized when the light is not blocked (retro and thru scan), or object is present (diffuse scan); the photosensor is illuminated.

### Alignment Indicators

Two LED indicators are located on top of the sensor head. Sufficient light level turns the green light ON. When the light level decreases to 150% of the minimum operating level, the red light turns ON.

### Sensitivity Adjustment

Use a small blade screwdriver to open the cover on top of the sensor head. This exposes the sensitivity adjustment screw, labeled "S".

The 15-turn sensitivity potentiometer will normally click at both extremes of the sensitivity range.

- Turn the screw clockwise to increase the sensitivity.
- Turn the screw counterclockwise to decrease sensitivity.
- Snap the cover closed and fasten with a screw.

### Fiber Optic Head Options

Fiber optic heads are furnished in two cable connection styles, MPF and MPG, as designated by the first three letters in their catalog listings.

MPF fiber optic sensor heads use dual slot glass cables and are part of the original MP product line. The sensor head has a dual slot end tip bezel connection on the sensor head which maintains compatibility with FE-MLS8C-FO sensors. With the MPZFOADPT adapter, the MPF heads can accept plastic cables too.

MPG fiber optic sensor heads use universal style glass cables. MPG heads accept the same universal style cables used with our MHP miniature high performance sensors and furnished by many manufacturers of photoelectric products. They cannot be used with plastic cables.



## PLUG-IN BASE

Specifications	DC	AC	AC/DC
MODEL NUMBER(S)	MPS30HD†	MPS10HD†	MPS18HD
	MPS31HD	MPS11HD	—
	MPS32HD	MPS12HD	—
	MPS33HD	MPS13HD†	—
	—	MPS17HD	—
OUTPUT	1 NPN (31HD) 1 PNP (32HD) 1 NPN and 1 PNP (33HD)	Solid state relay (11HD/12HD) Thyristor (17HD)	Thyristor
LOAD CURRENT	250 mA max. (31HD/32D) 100 mA max. (33HD)	5 mA-1 A (11HD/12HD) 100 mA max. (17HD)	100 mA max.
LEAKAGE CURRENT	≤ 10 µA	≤ 200 µA (11HD) ≤ 240 µA (12HD) ≤ 10 µA (17HD)	≤ 10 µA
INRUSH CURRENT	—	30 A for 8 ms (11HD/12HD) 250 mA for 8 ms (17HD)	250 mA for 8 ms, (non-repetitive)
VOLTAGE DROP	≤ 1.0 VDC (31HD/32HD) ≤ 0.8 VDC (33HD)	≤ 1.4 VAC at rated load (11HD/12HD) ≤ 3 V at 60 mA (17HD)	≤ 5 VDC (DC operation)
RESPONSE TIME*	≤ 10 µs	≤ 10 ms (11HD/12HD) ≤ 2 ms (17HD)	≤ 2 ms
SHORT CIRCUIT AND OVERLOAD PROTECTION	No (30HD/31HD/32HD) Yes (33HD)	No	No
REVERSE POLARITY PROTECTION	Yes	No	No
SUPPLY VOLTAGE	10-30 VDC	92-132 VAC, 50/60 Hz (10HD/11H/17HD) 198-264 VAC, 50/60 Hz (12HD/13HD)	10.8-140 VDC 18-140 VAC, 50/60 Hz
CURRENT CONSUMPTION	≤ 25 mA	≤ 70 mA	≤ 50 mA
ELECTRICAL CONNECTION	Dependent on receptacle selection	Dependent on receptacle selection	Dependent on receptacle selection
ADDITIONAL DATA	<b>See page 603</b>		

\*NOTE: Total response time is the sum of the sensor head and base response times.

†NOTE: Emitter base only.



## PLUG-IN BASE

### Plug-in Base Specifications

<b>TEMPERATURE RANGE</b>	<i>WORKING</i>	-22 °F to +158 °F
	<i>STORAGE</i>	-67 °F to +185 °F
<b>SHOCK</b>		50 G
<b>VIBRATION</b>		10 G, 10-500 Hz
<b>HUMIDITY RANGE</b>		95% RH (non-condensing)
<b>HEAD/BASE SEAL</b>		Santoprene
<b>RECEPTACLE/BASE SEAL</b>		Buna-N
<b>PROTECTION (IEC)</b>		IP69K when all components are properly assembled
<b>HOUSING MATERIAL</b>		Glass-filled Polysulfone
<b>STANDARDS</b>		EN 60947-5-2
<b>APPROVALS</b>		

### RECEPTACLE MODELS

<b>MPB20</b>	Standard 4-terminal, 1/2" NPT conduit thread
<b>MPB22</b>	5-pin mini connector
<b>MPB27</b>	4-pin micro connector



See pages  
803-854 for  
cordsets

## DPDT RELAY BASE

### Specifications

	AC
<b>MODEL NUMBER</b>	<b>MPSD11HD</b>
<b>SUPPLY VOLTAGE</b>	92-132 VAC, 50/60 Hz
<b>OUTPUT</b>	DPDT relay
<b>ELECTRICAL CONTACT RATING</b>	250 VAC/5 A
<b>POWER CONSUMPTION</b>	≤ 6.6 VA
<b>MECHANICAL LIFE OF RELAY</b>	5 x 10 <sup>7</sup> operations
<b>RESPONSE TIME*</b>	≤ 10 ms
<b>PROTECTION (IEC)</b>	IP69K when all components are properly assembled
<b>TEMPERATURE RANGE</b>	<i>WORKING</i> -22 °F to 158 °F <i>STORAGE</i> -67 °F to 185 °F
<b>SHOCK</b>	10G
<b>VIBRATION</b>	6 G, 10-55 Hz @ double amplitude of 1 mm
<b>HUMIDITY</b>	95% RH (non-condensing)
<b>HOUSING MATERIAL</b>	Glass-filled Polysulfone
<b>STANDARDS</b>	EN 60947-5-2
<b>APPROVALS</b>	
<b>ELECTRICAL CONNECTION</b>	dependent on receptacle selection



\*NOTE: Total response time is the sum of the sensor head and base response times.

### DPDT RECEPTACLE MODELS



<b>MPB23</b>	8-terminal, 1/2" NPT conduit thread
<b>MPB24</b>	8-terminal, PG 13.5 conduit thread



## SPDT RELAY BASE

Specifications		DC	AC
MODEL NUMBER(S)		MPV31HD	MPV11HD
		—	MPV12HD
		—	MPV13HD
		—	MPV14HD
OUTPUT	SPDT relay		
SUPPLY VOLTAGE	10-30 VDC	103-132 VAC, 50/60 Hz (11HD) 192-264 VAC, 50/60 Hz (12HD) 22-26 VAC, 50/60 Hz (13HD) 20-260 VAC/DC (14HD)	
POWER CONSUMPTION	≤ 10 VA	≤ 10 VA (11HD) ≤ 18.5 VA (12HD) ≤ 2 VA (13HD) ≤ 4 VA (14HD)	
ELECTRICAL CONTACT RATING	DC	28 V/6 A	24 V/6 A
	AC	300 V/6 A	300 V/ 6A
ELECTRICAL CONNECTION	 5-terminal 1/2" conduit hole	 5-terminal 1/2" conduit hole	



### SPDT Relay Base Specifications

MECHANICAL LIFE OF RELAY	20 x 10 <sup>6</sup> operations
RESPONSE TIME*	≤ 10 ms
TEMPERATURE RANGE	WORKING -22 °F to +158 °F
	STORAGE -67 °F to +185 °F
PROTECTION (IEC)	IP69K when all components are properly assembled
SHOCK	10 G
VIBRATION	10 G, 10-100 Hz
HUMIDITY RANGE	95% RH (non-condensing)
BASE	Glass-filled polycarbonate
COVER/BASE SEAL	Buna-N
HEAD/BASE SEAL	Santoprene
COVER	Die cast zinc
STANDARDS	EN 60947-5-2
APPROVALS	  

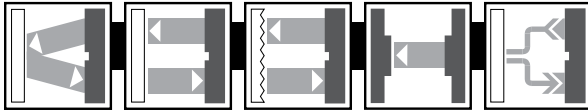
\*NOTE: Total response time is the sum of the sensor head and base response times.



## MINI STYLE BASE





Specifications	DC	AC	AC/DC
MODEL NUMBER(S)	MPT30HD† MPT31HD MPT32HD MPT33HD	MPT10HD† MPT11HD — MPT17HD	MPT16HD — — —
OUTPUT	1 NPN (31HD) 1 PNP (32HD) 1 NPN and 1 PNP (33HD)	Solid state relay (11HD) Thyristor (17HD)	Thyristor
LOAD CURRENT	250 mA max. (31HD/32D) 100 mA max. (33HD)	5 mA-500 mA (11HD) 100 mA max. (17HD)	100 mA max.
LEAKAGE CURRENT	≤ 10 µA	≤ 400 µA (11HD) ≤ 10 µA (17HD)	≤ 10 µA
INRUSH CURRENT	—	12 A for 16 ms (11HD) 250 mA for 8 ms (17HD)	250 mA for 8 ms, (non-repetitive)
VOLTAGE DROP	≤ 1 VDC (32HD/31HD) ≤ 0.6 VDC (33HD)	≤ 1.2 VAC at rated (11HD) ≤ 3 V (17HD)	≤ 3 V (DC operation)
RESPONSE TIME*	≤ 10 µs	≤ 10 ms (11HD) ≤ 2 ms (17HD)	≤ 2 ms
SHORT CIRCUIT AND OVERLOAD PROTECTION	No (30HD/31HD/32HD) Yes (33HD)	No	No
REVERSE POLARITY PROTECTION	No	No	No
SUPPLY VOLTAGE	10-30 VDC	92-132 VAC, 50/60 Hz (10HD/11H/17HD) 198-264 VAC, 50/60 Hz (12HD/13HD) 24 VAC, 50/60 Hz (14HD)	24 VAC/VDC
CURRENT CONSUMPTION	≤ 25 mA	≤ 70 mA	≤ 70 mA
ELECTRICAL CONNECTION	 2-meter cable, PVC covered, 4-conductor, #18 AWG	 2-meter cable, PVC covered, 4-conductor, #18 AWG	 2-meter cable, PVC covered, 4-conductor, #18 AWG
ADDITIONAL DATA	<b>See page 607</b>		

\*NOTE: Total response time is the sum of the sensor head and base response times.

†NOTE: Emitter base only.



## MINI STYLE BASE

Specifications	DC	DC	AC	AC/DC
MODEL NUMBER(S)	—	MPT40HD-CM†	MPT20HD†	MPT28HD
	MPT41HD	MPT41HD-CM	MPT21HD	—
	MPT42HD	MPT42HD-CM	MPT27HD	—
	MPT43HD	MPT43HD-CM	—	—
OUTPUT	1 NPN (41HD) 1 PNP (42HD) 1 NPN and 1 PNP (43HD)	1 NPN (41HD) 1 PNP (42HD) 1 NPN and 1 PNP (43HD)	Solid state relay (21HD) Thyristor (27HD)	Thyristor
LOAD CURRENT	250 mA max. (41HD/42D) 100 mA max. (43HD)	250 mA max. (41HD/42D) 100 mA max. (43HD)	500 mA max. (21HD) 100 mA max. (27HD)	100 mA max.
LEAKAGE CURRENT	≤ 10 µA	≤ 10 µA	≤ 400 µA (21HD) ≤ 10 µA (27HD)	≤ 10 µA
INRUSH CURRENT	—	—	12 A for 16 ms (21HD/22HD) 250 mA for 8 ms (27HD)	250 mA for 8 ms (non-repetitive)
VOLTAGE DROP	≤ 1 VDC (42HD/41HD) ≤ 0.6 VDC (43HD)	≤ 1 VDC (42HD/41HD) ≤ 0.6 VDC (43HD)	≤ 1.2 VAC (21HD) ≤ 3 V (27HD)	≤ 5 V (DC operation)
RESPONSE TIME*	≤ 10 µs	≤ 10 µs	≤ 10 ms (21HD) ≤ 2 ms (27HD)	≤ 2 ms
SHORT CIRCUIT AND OVERLOAD PROTECTION	No (40HD/41HD/42HD) Yes (43HD)	No (40HD/41HD/42HD) Yes (43HD)	No	No
REVERSE POLARITY PROTECTION	Yes	Yes	No	No
SUPPLY VOLTAGE	10-30 VDC	10-30 VDC	92-132 VAC, 50/60 Hz	10.8-140 VDC 18-140 VAC, 50/60 Hz
CURRENT CONSUMPTION	≤ 25 mA	≤ 25 mA	≤ 70 mA	≤ 70 mA
ELECTRICAL CONNECTION	 Quick disconnect type V94	 Quick disconnect type V1	 Quick disconnect type V93 (20HD) type V95 (21HD/27HD)	 Quick disconnect type V95
ADDITIONAL DATA	<b>See page 607</b>			

\*NOTE: Total response time is the sum of the sensor head and base response times.

†NOTE: Emitter base only.

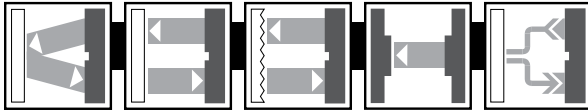

## MINI STYLE BASE

### Mini Style Base Specifications

<b>TEMPERATURE RANGE</b>	<i>WORKING</i>	-22 °F to +158 °F
	<i>STORAGE</i>	-67 °F to +185 °F
<b>SHOCK</b>		50 G
<b>VIBRATION</b>		10 G, 10-500 Hz
<b>HUMIDITY RANGE</b>		95% RH (non-condensing)
<b>BASE</b>		Glass-filled polycarbonate
<b>BASE SEAL</b>		Santoprene
<b>PROTECTION (IEC)</b>		IP69K when all components are properly assembled
<b>STANDARDS</b>		EN 60947-5-2
<b>HOUSING MATERIAL</b>		Glass-filled Polysulfone
<b>APPROVALS</b>		

## MINI RELAY BASE

### Specifications

		AC
<b>MODEL NUMBER(S)</b>		MPW11HD
		MPW21HD
<b>SUPPLY VOLTAGE</b>		92-132 VAC, 50/60 Hz
<b>POWER CONSUMPTION</b>		≤ 10 VA (including load)
<b>OUTPUT</b>		SPDT relay
<b>ELECTRICAL CONTACT RATING</b>	<i>DC</i>	30 V/6 A
	<i>AC</i>	125 V/6 A
<b>MECHANICAL LIFE OF RELAY</b>		50 x 10 <sup>6</sup> operations
<b>RESPONSE TIME*</b>		10 ms
<b>PROTECTION (IEC)</b>		IP69K when all components are properly assembled
<b>TEMPERATURE RANGE</b>	<i>WORKING</i>	-22 °F to 158° F
	<i>STORAGE</i>	-67 °F to 185 °F
<b>SHOCK</b>		20 G (no contact transfer) 100 G (no damage)
<b>VIBRATION</b>		10 G, 10-500 Hz
<b>HUMIDITY</b>		95% RH (non-condensing)
<b>HOUSING MATERIAL</b>		Glass-filled Polysulfone
<b>STANDARDS</b>		EN 60947-5-2
<b>APPROVALS</b>		
<b>ELECTRICAL CONNECTION</b>	<i>MPW11HD</i>	2-meter cable, PVC covered, 4-conductor, #18 AWG
	<i>MPW21HD</i>	Quick disconnect type V95

\*NOTE: Total response time is the sum of the sensor head and base response times.

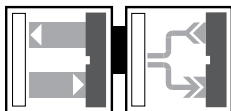

## ANALOG PLUG-IN BASE

Specifications		DC
SENSING RANGE		Determined by cable <sup>†</sup>
MODEL NUMBER(S)		MPS35HD
OUTPUT	Voltage	0-5 VDC
	Current	4-20 mA
LOAD CURRENT		5 mA max.
DRIFT	(68°F to 140°F)	3% typical
	(0 to 68°F)	6% typical
SHORT CIRCUIT AND OVERLOAD PROTECTION		No
REVERSE POLARITY PROTECTION		Yes
SUPPLY VOLTAGE		12-24 VDC
POWER CONSUMPTION		≤ 40 mA
REPEATABILITY		± 1% typical
PROTECTION (IEC)		IP69K when all components are properly assembled
TEMPERATURE RANGE	WORKING	+32 °F to 140 °F
	STORAGE	-67 °F to 185 °F
HOUSING MATERIAL		Glass-filled Polysulfone
SHOCK		50 G
VIBRATION		10 G, 10-500 Hz
HUMIDITY		95% RH (non-condensing)
STANDARDS		EN 60947-5-2
APPROVALS		
ELECTRICAL CONNECTION		Dependent on receptacle selected

### APPLICATION CONSIDERATION

The MPF5HD head emits an IR beam, which is bounced off the detected object and returned. Depending on the distance to the object and its reflectivity, the head produces a signal with a magnitude proportional to the sensed distance between the object and the head. The MPS35 uses this signal to produce a voltage output and a current output.

The MPS35HD base provides a voltage output from 0-5VDC. The voltage output sources voltage to the user's load, which is then connected to the MPS35HD's negative supply terminal or ground. Current flows from the voltage output to ground. The voltage output can only supply up to 5mA of current and therefore, the load impedance must be 1000 ohms or more. Lower impedances will produce false output voltage readings.

The MPS35HD base also provides a current output from 4-20mA. The user's load is connected from the MPS35HD's positive supply terminal and to the analog current "output" terminal. The "output" pin sinks current (current flows into it). Output current is monitored through an internal resistor in the current amplifier. As the target is moved toward the sense head, increased current is sent to the load and to the sense resistor. Without limitations, this current would produce voltages across these two resistances that would exceed the MPS35HD's supply voltage. Under these conditions, the output current will reach some value and just stay there. Therefore, to ensure proper operation of the MPF5HD/ MPS35HD sensor, the current output load resistance cannot exceed 250 ohms. The current output can only operate with loads of 0-250 ohms.

The MPF5HD head produces only one output signal from which the MPS35HD produces its voltage output. The voltage output is then used to run the current amplifier via an internal connection. There is only one set of range and offset adjustments provided. These adjust both the voltage and current outputs. Due to differences in the two amplifiers, only one output can be set accurately. Therefore only one output should be used with the other left unconnected. Should it be necessary to use both outputs, the voltage output must see a minimum load resistance of 5000 ohms. This is necessary to prevent overloading of the sensor, which could produce incorrect output voltage and current values.



<sup>†</sup>See pages 761-796 for fiber optic lengths and specifications.

### RECEPTACLE MODELS

MPB20	Standard 4-terminal, 1/2" NPT conduit thread
MPB22	5-pin mini connector



See pages 803-854 for cordsets





## 2-WIRE AC BASE

Specifications	AC/DC	AC
MODEL NUMBER(S)	MPS14HD†	MP2S11HD
SUPPLY VOLTAGE	22-26 VAC/DC	22-260 VAC
POWER CONSUMPTION	70 mA	—
OUTPUT	—	Solid state AC relay
LOAD CURRENT	—	500 mA max.
LEAKAGE CURRENT	—	≤ 1.9 mA
INRUSH CURRENT	—	5 A/8 ms
VOLTAGE DROP	—	≤ 10 V
RESPONSE TIME*	—	≤ 2 ms
SHORT CIRCUIT AND OVERLOAD PROTECTION	No	No
REVERSE POLARITY PROTECTION	No	Yes
ELECTRICAL CONNECTION	Dependent on receptacle selected	Dependent on receptacle selected

\*NOTE: Total response time is the sum of the sensor head and base response times.

†NOTE: Emitter base only.

**NOTE: For specifications on Models: MPS10HD, MPS13HD and MPS30HD emitter bases, see pages 602-603**

### 2-Wire AC Base Specifications

PROTECTION (IEC)	IP69K when all components are properly assembled	
TEMPERATURE RANGE	WORKING	-22 °F to +158 °F
	STORAGE	-67 °F to +185 °F
HOUSING MATERIAL	Glass-filled Polysulfone	
SHOCK	50 G	
VIBRATION	10 G, 10-500 Hz	
HUMIDITY RANGE	95% RH (non-condensing)	
PLUG-IN RECEPTACLE	Die-cast zinc	
STANDARDS	EN 60947-5-2	
APPROVALS		

### RECEPTACLE MODELS

MPB20	Standard 4-terminal, 1/2" NPT conduit thread
MPB22	5-pin mini connector



See pages 803-854 for cordsets

## Standard Head Sensing Characteristics

### Diffuse Scan Sensing Characteristics

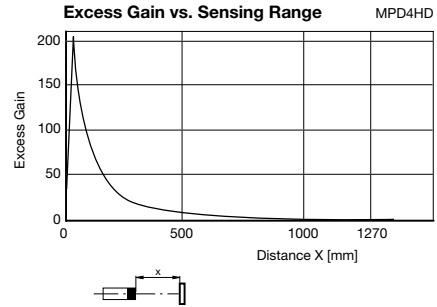
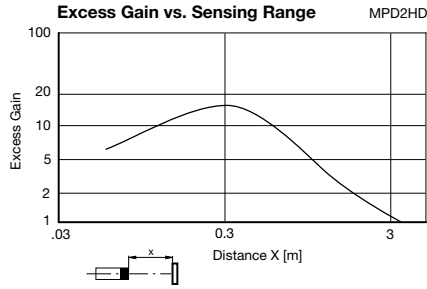

### Diffuse Scan Sensing Characteristics

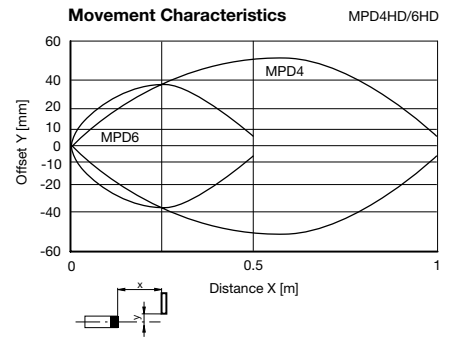
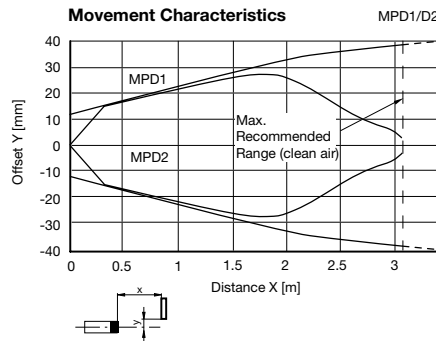
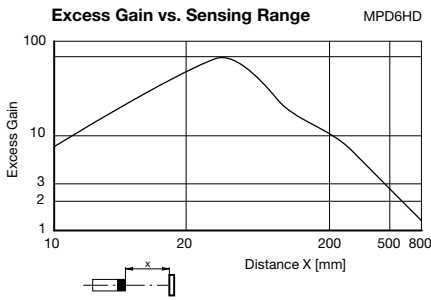

### Polarized Scan Sensing Characteristics

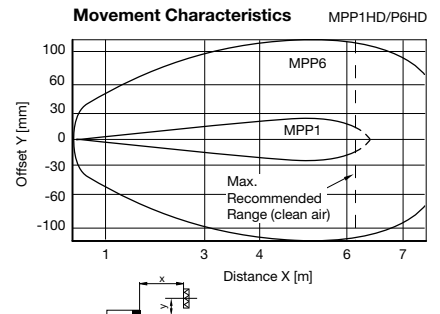
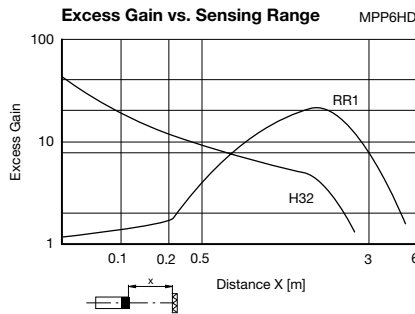
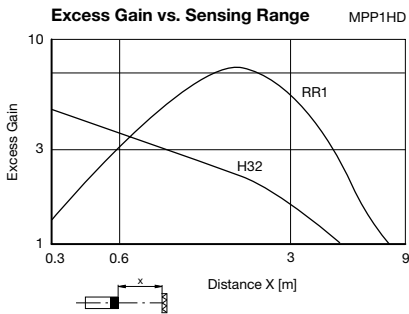

### Retro-Reflective Scan Sensing Characteristics

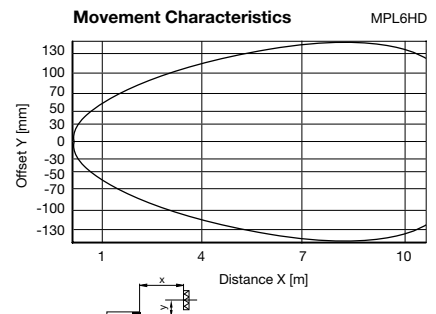
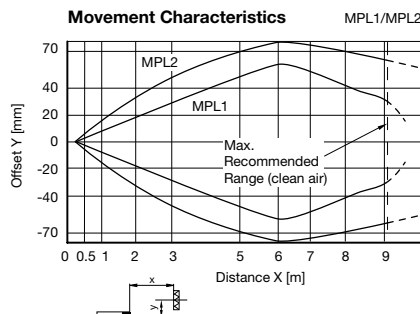
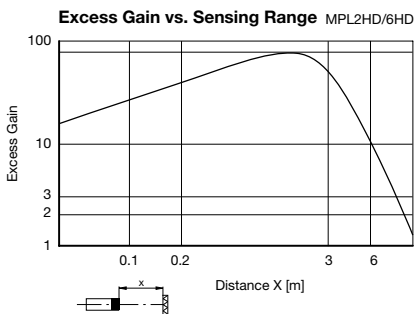

## Standard Head Sensing Characteristics

### Thru-Beam Scan Sensing Characteristics

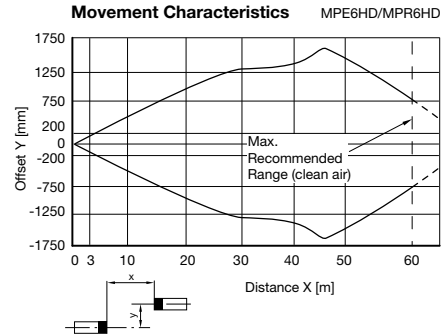
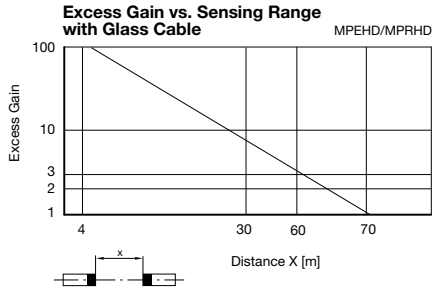

### Fiber Optic Sensing Characteristics

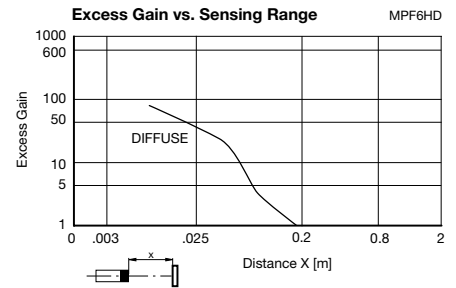
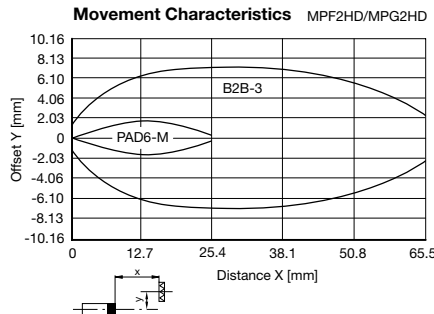
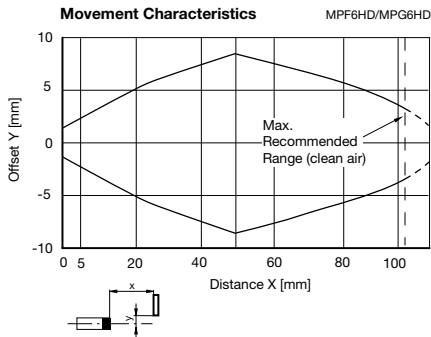

## 2-Wire AC Head Sensing Characteristics

### Diffuse Scan Sensing Characteristics

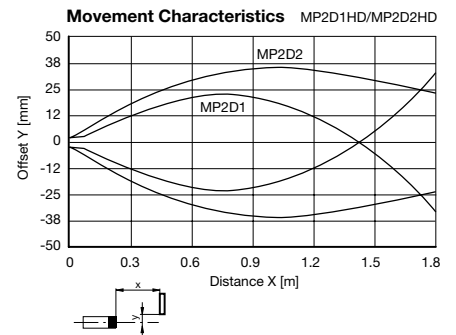
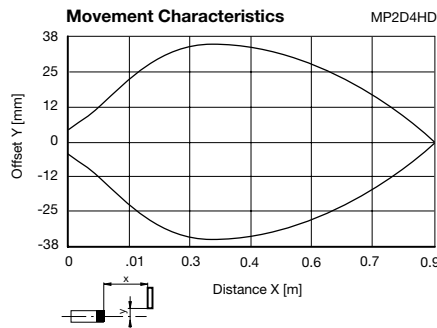
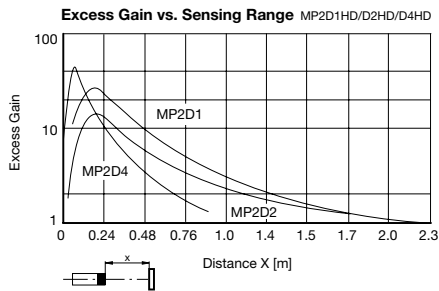

### Polarized Scan Sensing Characteristics

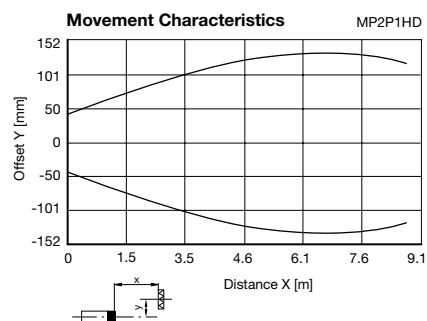
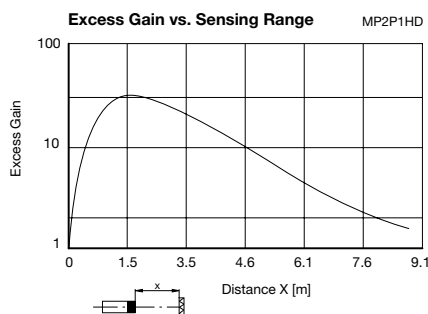

2-Wire AC Head Sensing Characteristics

Retro-Reflective Scan Sensing Characteristics

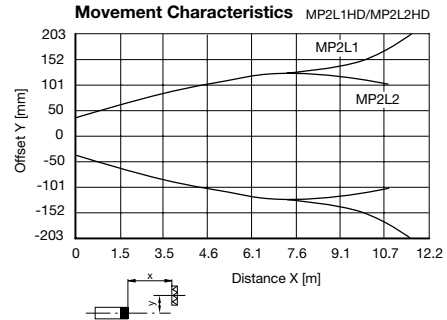
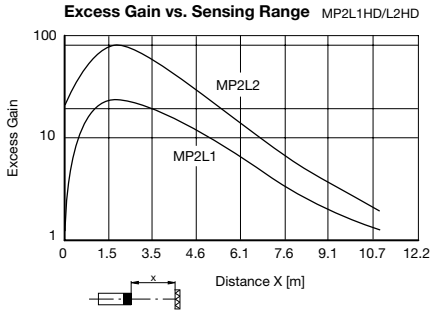

Thru-Beam Scan Sensing Characteristics

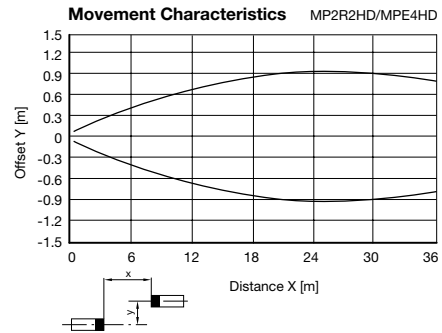
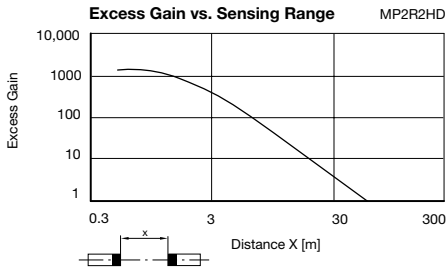

Fiber Optic Diffuse Scan Sensing Characteristics

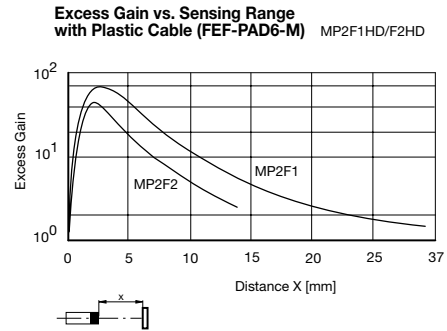
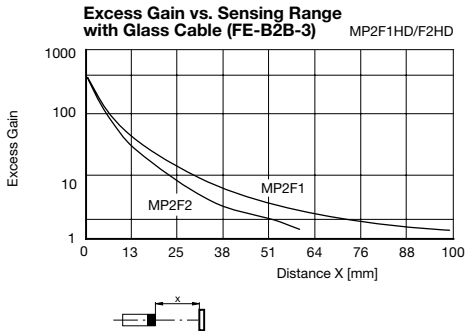

## Wiring Diagrams

### AC



#### Terminal Connection

Model: MPS10HD

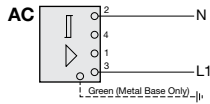

Model: MPS11HD

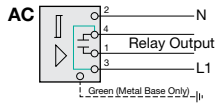

NOTE: Pins 3 and 4 must be jumpered (jumper wire not included)

Model: MPS12HD

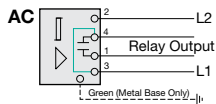

NOTE: Pins 3 and 4 must be jumpered (jumper wire not included)

Model: MPS13HD

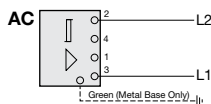

Model: MPS17HD

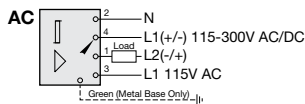

Model: MPV11HD

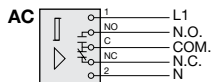

Model: MPV12HD

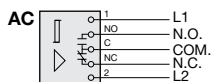

Model: MPV13HD

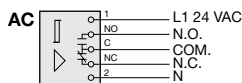

Model: MPSD11HD

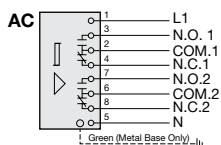

Model: MP2S11HD

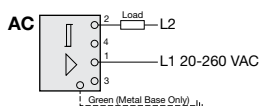

### DC



#### Terminal Connection

Model: MPS30HD

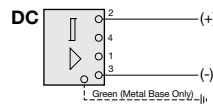

Model: MPS31HD

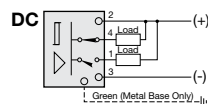

Model: MPS32HD

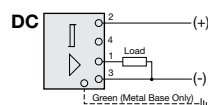

Model: MPS33HD

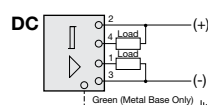

Model: MPV31HD

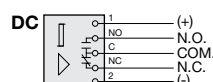

Model: MPS35HD

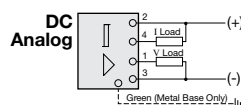

### AC/DC



#### Terminal Connection

Model: MPS16HD

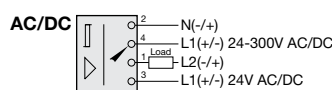

Model: MPS18HD

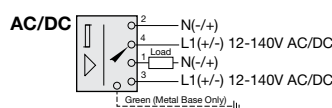

Model: MPV14HD

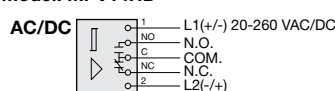

### AC



#### Cable Connection

Model: MPT10HD

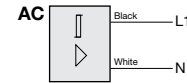

Model: MPT11HD

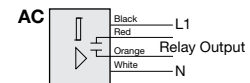

NOTE: Relay also requires AC power

Model: MPT17HD

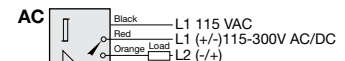

Model: MPW11HD

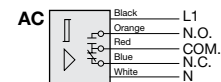

Model: MP2T11HD

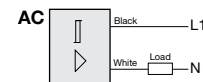

### DC



#### Cable Connection

Model: MPT30HD

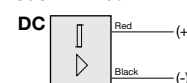

Model: MPT31HD

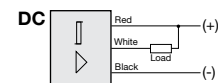

Model: MPT32HD

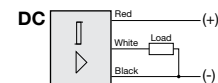

Model: MPT33HD

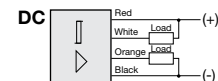

## Wiring Diagrams

### AC/DC



#### Cable Connection

Model: MPT16HD

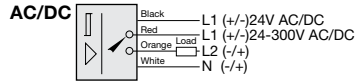

### AC



#### Mini Quick Disconnect

Note: Wiring diagrams show quick disconnect pin numbers.

#### V93 Type

Model: MPT20HD

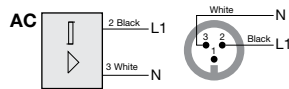

#### V95 Type

Model: MPT21HD

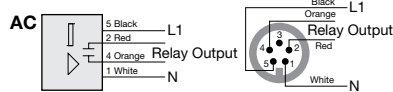

Model: MPT27HD

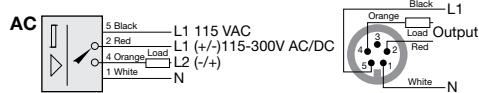

Model: MPW21HD

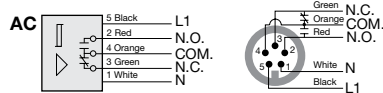

### AC/DC



#### Mini Quick Disconnect

Note: Wiring diagrams show quick disconnect pin numbers.

#### V95 Type

Model: MPT28HD

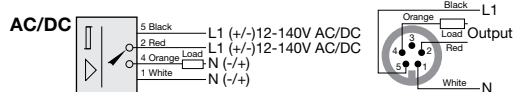

Model: MPB22

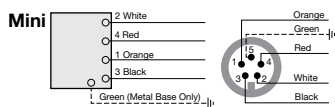

### DC



#### Mini Quick Disconnect

Note: Wiring diagrams show quick disconnect pin numbers.

#### V94 Type

Model: MPT41HD

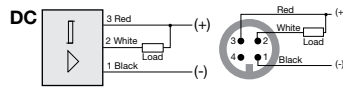

Model: MPT42HD

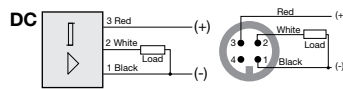

Model: MPT43HD

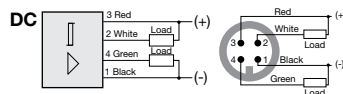

### DC



#### Micro Quick Disconnect

Note: Wiring diagrams show quick disconnect pin numbers.

#### V1 Type

Model: MPT40HD-CM

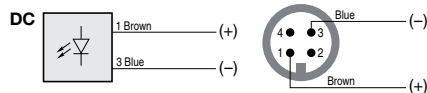

Model: MPT41HD-CM

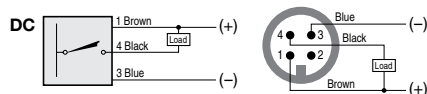

Model: MPT42HD-CM

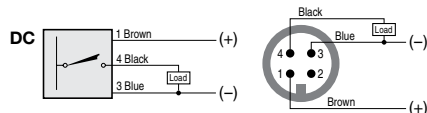

Model: MPT43HD-CM

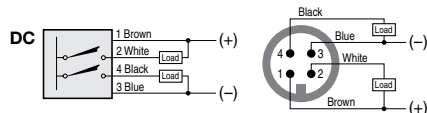

Model: MPB27

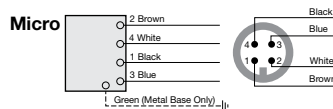

## Dimensions (mm)

### SENSOR HEAD, BASE AND RECEPTACLE DIMENSIONS

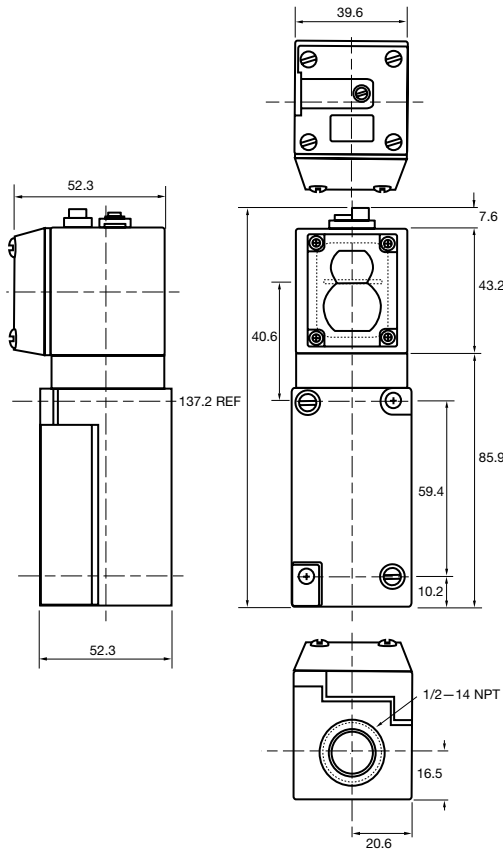

### FIBER OPTIC SENSOR HEAD DIMENSIONS

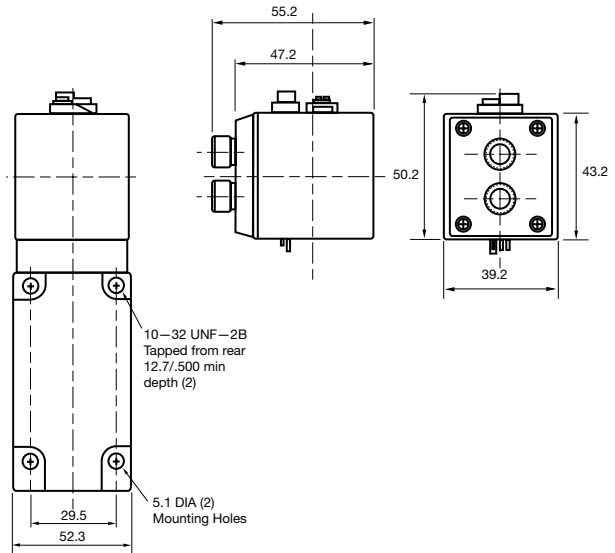

### SENSOR HEAD WITH MINI RELAY BASE DIMENSIONS

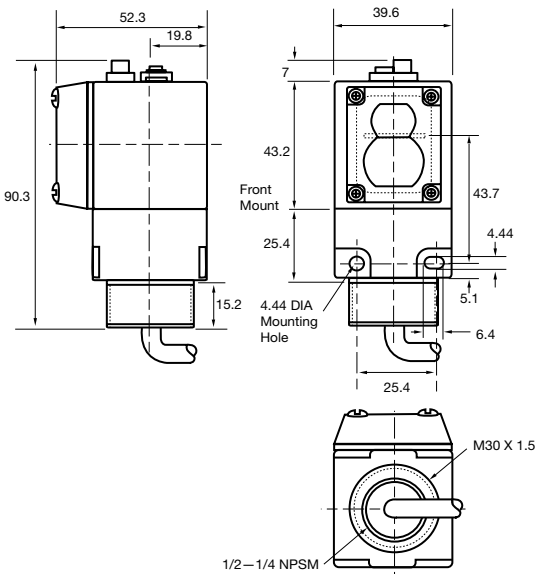

### QUICK DISCONNECT MINI BASE DIMENSIONS

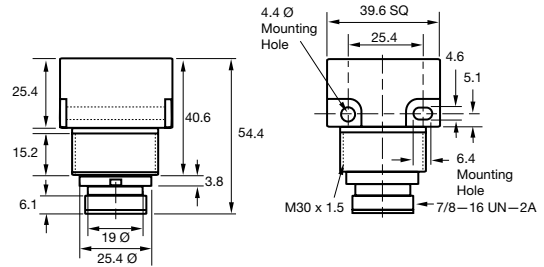

### QUICK DISCONNECT MICRO BASE DIMENSIONS

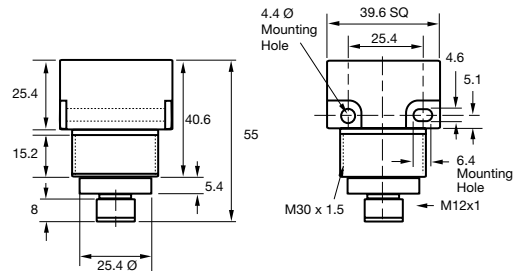

## MULTIFUNCTION TIMER/LOGIC CARD

### FOR A COMPLETE CONTROL

- Multifunction Time/logic Card
- Photoelectric Sensor Head
- Reflector (Retro and Polar Scans)

### CHOICE OF:

- Plug-in base
- Plug-in Receptacle
- Mini Base
- Relay Base



### Multifunction Logic Cards

Model No.	Description
MPA1HD	0.15 to 15 sec. time adjustment
MPA155HD	1 to 30 sec. adjustment
MPA188HD	0.01 to 1 sec. adjustment

Plug-in timer/logic cards easily convert any ON/OFF MP Series photoelectric into a multifunction control. Seven DIP switches located on the timer card provide the user with a choice of seven delay functions including dual delay and motion detection. In addition, light operated or dark operated sensing can be selected by a switch located on the photoelectric sensor head.

### TIME DELAY OPTIONS

The timer/logic cards can be set up to modify the sensor's head output signal. For instance, in thru-scan or reflective scan (L.O. mode), if the logic card is set for OFF delay the sensor does not immediately turn off its output circuit after the beam goes dark or is blocked. Instead it waits until the beam has been dark for a preset time. If set for ON delay, the sensor waits for a preset to time to recognize that the beam is complete.

Each timer/logic card has seven DIP switches to select ON delay, OFF delay, or both. The delays range as shown in the Specifications and Order Guide. The cards also offer totally independent range selection and adjustment for ON and OFF delays.

### ONE SHOT OPTIONS

In addition, the timer/logic card offers four modes of operation: 1-shot, a delayed 1-shot, 1-shot drop, and a delayed 1-shot drop. The cards can be adjusted for both the width of the 1-shot pulse and the length of delay before the 1-shot is fired.

### TIMING OPTION SETTINGS

Prior to inserting a multifunction timer card into the photoelectric sensor head, you must properly set DIP switches located on the card. You must also set the L.O./D.O. switch located in the photoelectric sensor head.

### TIMING ADJUSTMENTS

On the top of the MP Series photoelectric sensor head is an access cover. When opened with a small blade screwdriver, the multi-turn timer adjustment screws, labeled "1" and "2," are exposed.

Clockwise rotation increases the time range(s). If a single delay option is selected, the other timer adjustment is automatically set to zero. When the sensor head has been set to the desired timing range(s), snap the access cover shut to provide proper head sealing.

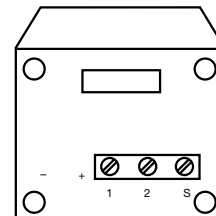



## MULTIFUNCTION TIMER/LOGIC CARD

### Timing Options Settings

DIP switches on the card are labeled 1-7, with OFF position toward the labels. Refer to the timing chart below for DIP switch settings and their results for a retro-reflective or thru-beam setup.

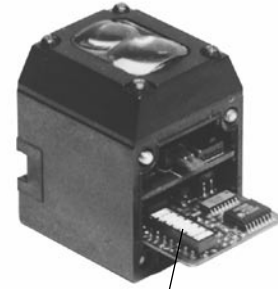

DIP SWITCHES 1-7

■ Timing/Adjustment

T1 denotes screw adjustment 1

T2 denotes screw adjustment 2

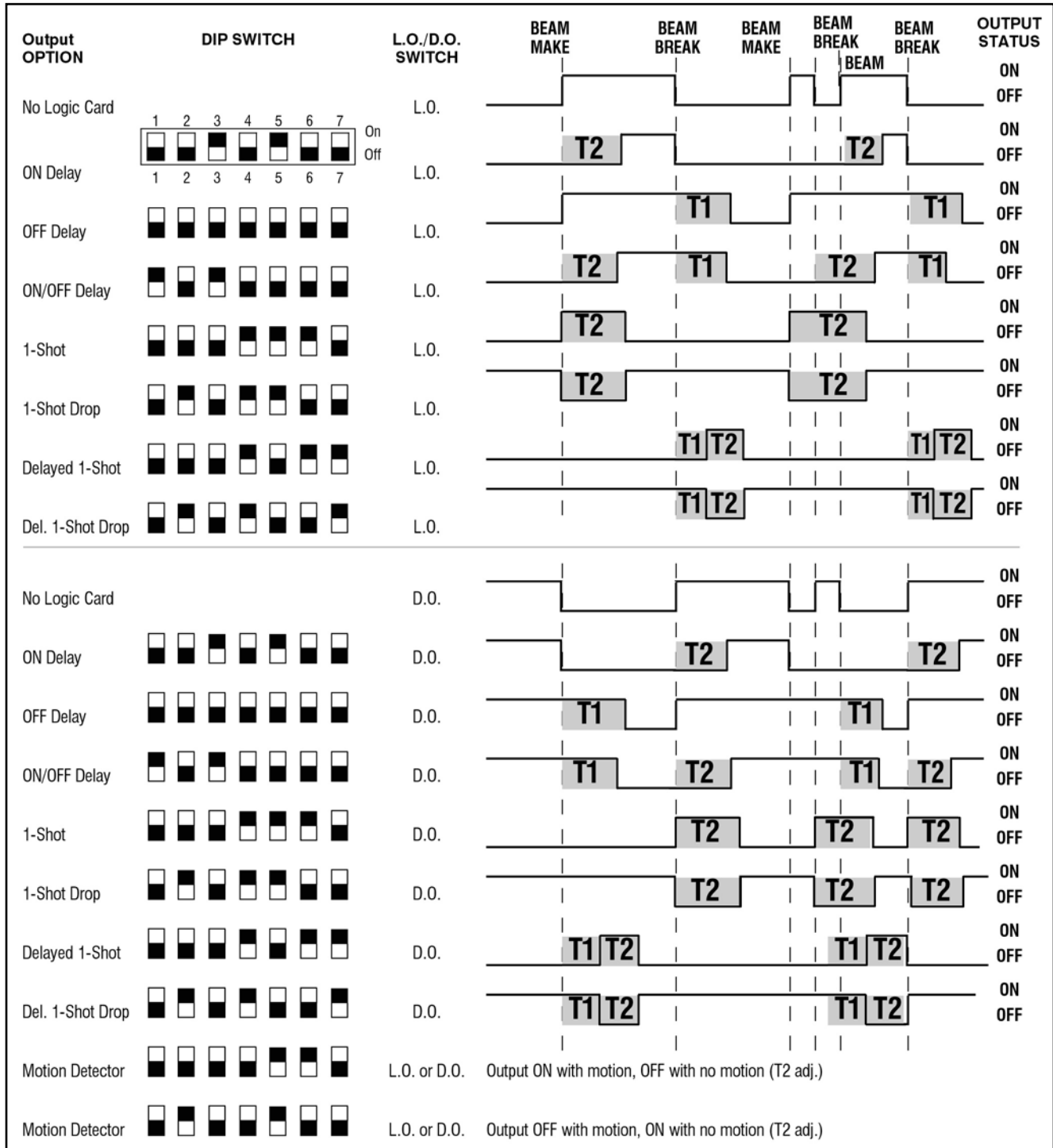

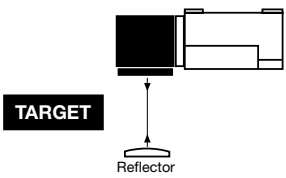
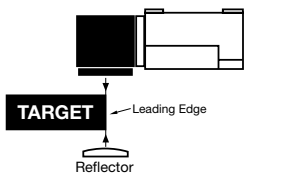
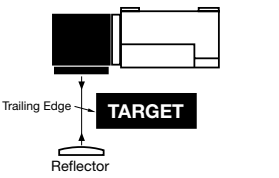
				
		<b>NO TARGET</b>	<b>TARGET PRESENT LEADING EDGE</b>	<b>TARGET GONE TRAILING EDGE</b>
ON Delay	Dark On	Output is OFF	Output doesn't turn on until the time delay period has expired.	Output is OFF
	Light On	Output is ON	Output is OFF	Output doesn't turn back on until the delay period has expired.
OFF Delay	Dark On	Output is OFF	Output is ON	Output remains on for the amount of time set for the off delay. The output turns off when the delay period has expired.
	Light On	Output is ON	Output will not turn off until the time delay has expired.	Output turns back on.
ON/OFF Delay	Dark On	Output is OFF	Output doesn't turn on until the time delay period has expired.	Output doesn't turn back off until the time delay period has expired
	Light On	Output turns on after the time delay period has expired.	Output turns off after the time delay period has expired.	Output turns back on after the delay period has expired.
1-shot	Dark On	Output is OFF	The output turns on as soon as the target is present. The output will remain on only for the amount of time set.	If the time set for the output to turn on has not run out, the output will remain on. If the time set for the output to remain on expired while the target was still in front of the sensor and the output turned back off, the output will remain off.
1-shot Drop	Dark On	Output is ON	Output turns off only for the amount of time set. When that time expires, the output will turn back on.	If the time set for the output to turn off has not expired, the output will remain off. If the time set for the output to remain off expired while the target was still in front of the sensor and the output turned back on, the output will remain on.
	Light On	Output is ON	Output remains ON	Output turns off only for the amount of time set. When that time expires, the output will turn back on.
Delayed 1-shot	Dark On	Output is OFF	Output is OFF	Output turns on after the time delay period has expired. Output remains on only for the time period set, when that time expires the output will turn back off.
	Light On	Output is OFF	Output turns on after the time delay period expires. Output turns on only for the time period set. When that time expires, the output will turn back off.	Output remains off if the one shot time period has expired. If the one shot period hasn't expired, the output will remain on.
Delayed 1-shot Drop	Dark On	Output is ON	Output is ON	Output turns off after the time delay period has expired. Output turns off only for the time period set, when that time expires, the output will turn back on.
	Light On	Output is ON	Output turns off after the time delay period expires. Output turns on only for the time period set. When that time expires, the output will turn back on.	Output remains off if the one shot time period had expired. If the one shot period hasn't expired, the output will remain on.
		<b>TARGET MOVING CONDITIONS</b>	<b>TARGET NOT MOVING CONDITIONS</b>	
Motion Detector OFF with no Motion	Light or Dark On	Output is ON	Output is OFF	
Motion Detector ON with no Motion	Light or Dark On	Output is OFF	Output is ON	

## Accessories

(Dimensions in mm)

### Mounting Brackets

Optional mounting brackets (MPZB01 or MPZB02) can be provided that fit around the threaded portion of the mini base. The brackets allow the base to rotate 360°. A 30 mm mounting nut and lockwasher is included for securing the mini base to the bracket.

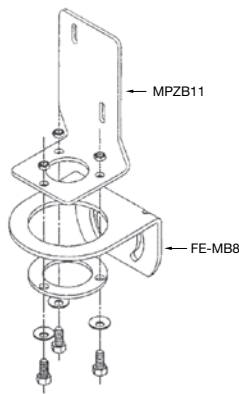
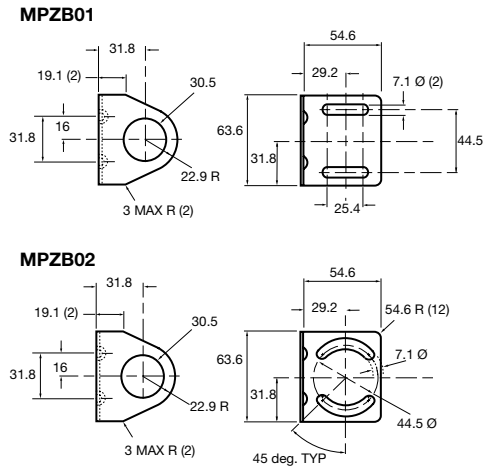

MPZB12

### Swivel Mounting Brackets

The basic ball and swivel mounting bracket (360° swivel 10° tilt) consists of two plastic brackets and the spherical plastic swivel nut. The swivel nut has M30 threading for direct installation of the MPT (mini MP base), including the quick disconnect versions. The bracket (MPZB06) can be directly mounted to a surface, or the MPZB07 mounting plate may be used. The MPZB08 adapter allows you to connect the ball and swivel bracket to the MP relay (MPV) and MP plug-in bases (MPS).

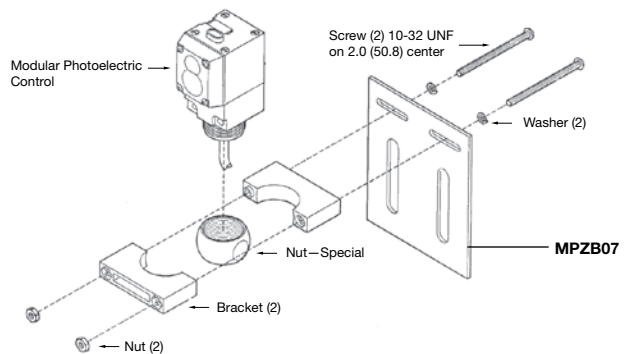

Exploded View of MPZB06

### Mounting Brackets

Model No.	Description
MPZB01	Mini MP mounting bracket, vertical slots
MPZB02	Mini MP mounting bracket, circular slots
MPZB06	Ball and swivel mounting bracket (fits 30mm mini MP)
MPZB07	Ball and swivel vertical mounting plate
MPZB08	Adapter (use with MPZB06 to fit 1/2" conduit hole)
MPZB12	Photoswitch 4000 (MLS8C) to limit switch style (combination of the MPZB11 and FE-MB8)
MPZB14	Combination of the MPZB06 and MPZB07 bracket

### Other Accessories

Model No.	Description
MPZFOADPT	Pair of fiber cable adapters allows use of cuttable 1000 micron plastic cable
MPZN01	Mini base steel mounting nut and lockwasher
MPZN02	Mini base plastic mounting nut and lockwasher
MPGKITC	Pair of cable end tips and accessories for universal cables
MPZR01	Replacement relay for MPV series—6A SPDT
MPZR02	Replacement relay for MPSD series—5A DPDT

Notes

Photoelectric MP Series Modular

## X-ON Electronics

Largest Supplier of Electrical and Electronic Components

*Click to view similar products for [pepperl & fuchs](#) manufacturer:*

Other Similar products are found below :

[NBN4-12GM50-E3](#) [RL31-54/73C/136](#) [52FR1](#) [MPS11HD](#) [NBB5-18GM50-E2](#) [NBN4-12GM50-E2](#) [UC2000-30GM-IUR2-V15](#) [3RG4038-3KB00](#) [3RG7134-3AA00](#) [RL31-8-1200-RT/73C/136](#) [UC-30GM-R2](#) [UC2000-30GM-E6R2-V15](#) [6GR6221-3AB00](#) [ML100-55/98/103](#) [M100/MV100-RT/35/76A/95/103](#) [3RG4013-0KB00](#) [3RG4148-3CD00](#) [3RG4023-3AG33](#) [INX360D-F99-I2E2-V15](#) [MD17/73](#) [MV17/73/136](#) [NBB8-18GM50-E2-V1](#) [ACX04-F99-I-V15](#) [NBB15-30GM50-E2-V1](#) [NBB20-L2-E2-V1](#) [REF-C110-2](#) [REF-MH50](#) [UB400-F77-E2-V31](#) [50FY416](#) [NBN4-12GM40-Z0](#) [40621](#) [3RG4013-3KB00](#) [3RG6233-3JS00](#) [ML100-55/95/103](#) [NJ2-PD-US-2.062-V93](#) [NBN8-12GM50-E2](#) [UB800-18GM40-E5-V1](#) [3RG4200-1AB00](#) [RT1 X 100](#) [UB800-18GM40-I-V1](#) [3RG7120-3AA00](#) [NBB8-18GM60-A2-V1](#) [UB4000-F42-I-V15](#) [OB-150-F6-E5](#) [41FR2](#) [NBB20-L2-A2-V1](#) [REF-H85-2](#) [6GR6231-3AB00](#) [6GR6222-3AB00](#) [NBB15+U1+E2](#)