

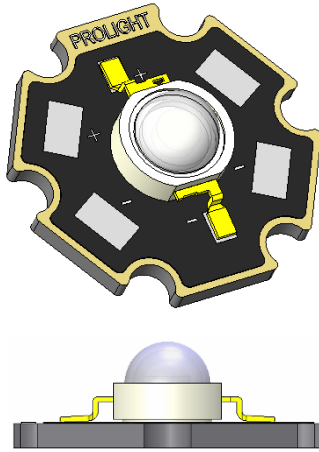

ProLight Opto
Technology Corporation



ProLight PM2B-3LxS-SD
3W Power LED
Technical Datasheet
Version: 2.6

Features

- High flux per LED
- Various colors
- Good color uniformity
- RoHS compliant
- More energy efficient than incandescent and most halogen lamps
- Low Voltage DC operated
- Instant light (less than 100ns)
- No UV
- Superior ESD protection

Typical Applications

- Reading lights (car, bus, aircraft)
- Portable (flashlight, bicycle)
- Uplighters/Downlighters
- Decorative/Entertainment
- Bollards/Security/Garden
- Cove/Undershelf/Task
- Indoor/Outdoor Commercial and Residential Architectural
- Automotive Ext (Stop-Tail-Turn, CHMSL, Mirror Side Repeat)
- LCD backlights

Star Mechanical Dimensions

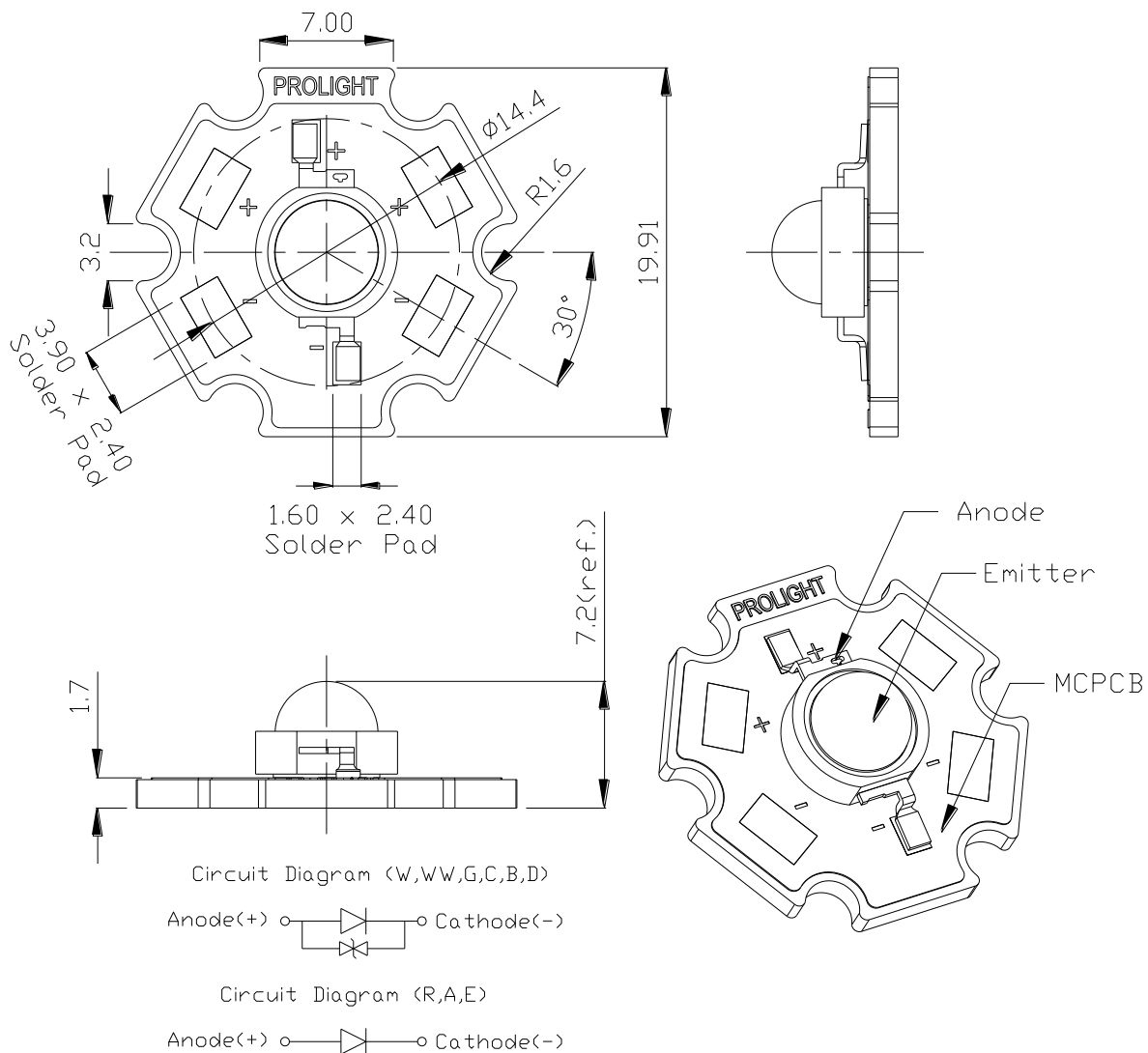

Notes:

1. Slots in aluminum-core PCB for M3 or #4 mounting screw.
2. Electrical interconnection pads labeled on the aluminum-core PCB with "+" and "-" to denote positive and negative, respectively. All positive pads are interconnected, as are all negative pads, allowing for flexibility in array interconnection.
3. Drawing not to scale.
4. All dimensions are in millimeters.
5. Unless otherwise indicated, tolerances are ± 0.20 mm.
6. **Please do not use a force of over 3kgf impact or pressure on the lens of the LED, otherwise it will cause a catastrophic failure.**

*The appearance and specifications of the product may be modified for improvement without notice.

ProLight

Flux Characteristics at 700mA, T_J = 25°C

Radiation Pattern	Color	Part Number Star	Lumious Flux or Power	
			Minimum	Typical
Lambertian	White	PM2B-3LWS-SD	218.9 lm	270 lm
	Warm White	PM2B-3LVS-SD	218.9 lm	260 lm
	Red	PM2B-3LRS-SD	87.4 lm	98 lm
	Amber	PM2B-3LAS-SD	87.4 lm	106 lm
	Green	PM2B-3LGS-SD	129.5 lm	178 lm
	Cyan	PM2B-3LCS-SD	113.6 lm	133 lm
	Blue	PM2B-3LBS-SD	39.8 lm	50 lm
	Royal Blue	PM2B-3LDS-SD	755 mW	1000 mW
	Cherry Red	PM2B-3LES-SD	435 mW	490 mW

- ProLight maintains a tolerance of ± 10% on flux and power measurements.
- Please do not drive at rated current more than 1 second without proper heat sink.

Electrical Characteristics at 700mA, T_J = 25°C

Color	Forward Voltage V _F (V)			Thermal Resistance Junction to Board (°C/ W)
	Min.	Typ.	Max.	
White	3.1	3.6	4.1	11
Warm White	3.1	3.6	4.1	11
Red	2.0	2.5	3.25	11
Amber	2.0	2.5	3.25	11
Green	3.1	3.8	4.35	11
Cyan	3.1	3.8	4.35	11
Blue	3.1	3.6	4.1	11
Royal Blue	3.1	3.6	4.1	11
Cherry Red	1.75	2.3	3.0	11

- ProLight maintains a tolerance of ± 0.1V for Voltage measurements.

Optical Characteristics at 700mA, T_J = 25°C

Color	Dominant Wavelength λ_D , Peak Wavelength ^[1] λ_P , or Color Temperature CCT			Total included Angle (degrees) $\theta_{0.90V}$	Viewing Angle (degrees) $2 \theta_{1/2}$
	Min.	Typ.	Max.		
White	4100 K	5500 K	10000 K	180	130
Warm White	2700 K	3300 K	4100 K	180	130
Red	613.5 nm	623 nm	631 nm	180	130
Amber	587 nm	592 nm	597 nm	180	130
Green	515 nm	525 nm	535 nm	180	130
Cyan	495 nm	505 nm	515 nm	180	130
Blue	455 nm	465 nm	475 nm	180	130
Royal Blue	450 nm	455 nm	460 nm	180	130
Cherry Red ^[1]	720 nm	730 nm	740 nm	180	130

- ProLight maintains a tolerance of ± 1 nm for dominant wavelength measurements.
- ProLight maintains a tolerance of $\pm 5\%$ for CCT measurements.
- ^[1] Cherry Red product is binned by peak wavelength rather than dominant wavelength.

Absolute Maximum Ratings

Parameter	White/Warm White/Red/Amber/ Green/Cyan/Blue/Royal Blue/Cherry Red
DC Forward Current (mA)	700
Peak Pulsed Forward Current (mA)	1000 (less than 1/10 duty cycle@1KHz)
Average Forward Current (mA)	700
ESD Sensitivity (HBM per MIL-STD-883E Method 3015.7)	$\pm 4000V$ (Class III)
LED Junction Temperature	120°C
Operating Board Temperature at Maximum DC Forward Current	-40°C - 90°C
Storage Temperature	-40°C - 120°C
Reverse Voltage	Not designed to be driven in reverse bias

Radiometric Power Bin Structure

Color	Bin Code	Minimum Radiometric Power (mW)	Maximum Radiometric Power (mW)	Available Color Bins
Royal Blue	T	755	875	[1]
	U	875	1050	All
	V	1050	1225	All
	W	1225	1400	[1]
Cherry Red	Q	435	515	All
	R	515	635	[1]

- ProLight maintains a tolerance of $\pm 10\%$ on flux and power measurements.
- The flux bin of the product may be modified for improvement without notice.
- ^[1] The rest of color bins are not 100% ready for order currently. Please ask for quote and order possibility.

Photometric Luminous Flux Bin Structure

Color	Bin Code	Minimum Photometric Flux (lm)	Maximum Photometric Flux (lm)	Available Color Bins
White	X2	218.9	249.6	All
	Y1	249.6	284.5	All
	Y2	284.5	324.5	[1]
Warm White	X2	218.9	249.6	All
	Y1	249.6	284.5	All
	Y2	284.5	324.5	[1]
Red	U1	87.4	99.6	All
	U2	99.6	113.6	All
	V1	113.6	129.5	[1]
Amber	U1	87.4	99.6	All
	U2	99.6	113.6	All
	V1	113.6	129.5	[1]
Green	V2	129.5	147.7	[1]
	W1	147.7	168.4	All
	W2	168.4	192	All
	X1	192	218.9	[1]
Cyan	V1	113.6	129.5	All
	V2	129.5	147.7	All
	W1	147.7	168.4	[1]
Blue	R	39.8	51.7	A, 1 ^[1]
	S1	51.7	58.9	[1]
	S2	58.9	67.2	[1]

- ProLight maintains a tolerance of $\pm 10\%$ on flux and power measurements.
- The flux bin of the product may be modified for improvement without notice.
- ^[1] The rest of color bins are not 100% ready for order currently. Please ask for quote and order possibility.

Color Bin

White and Warm White Binning Structure Graphical Representation

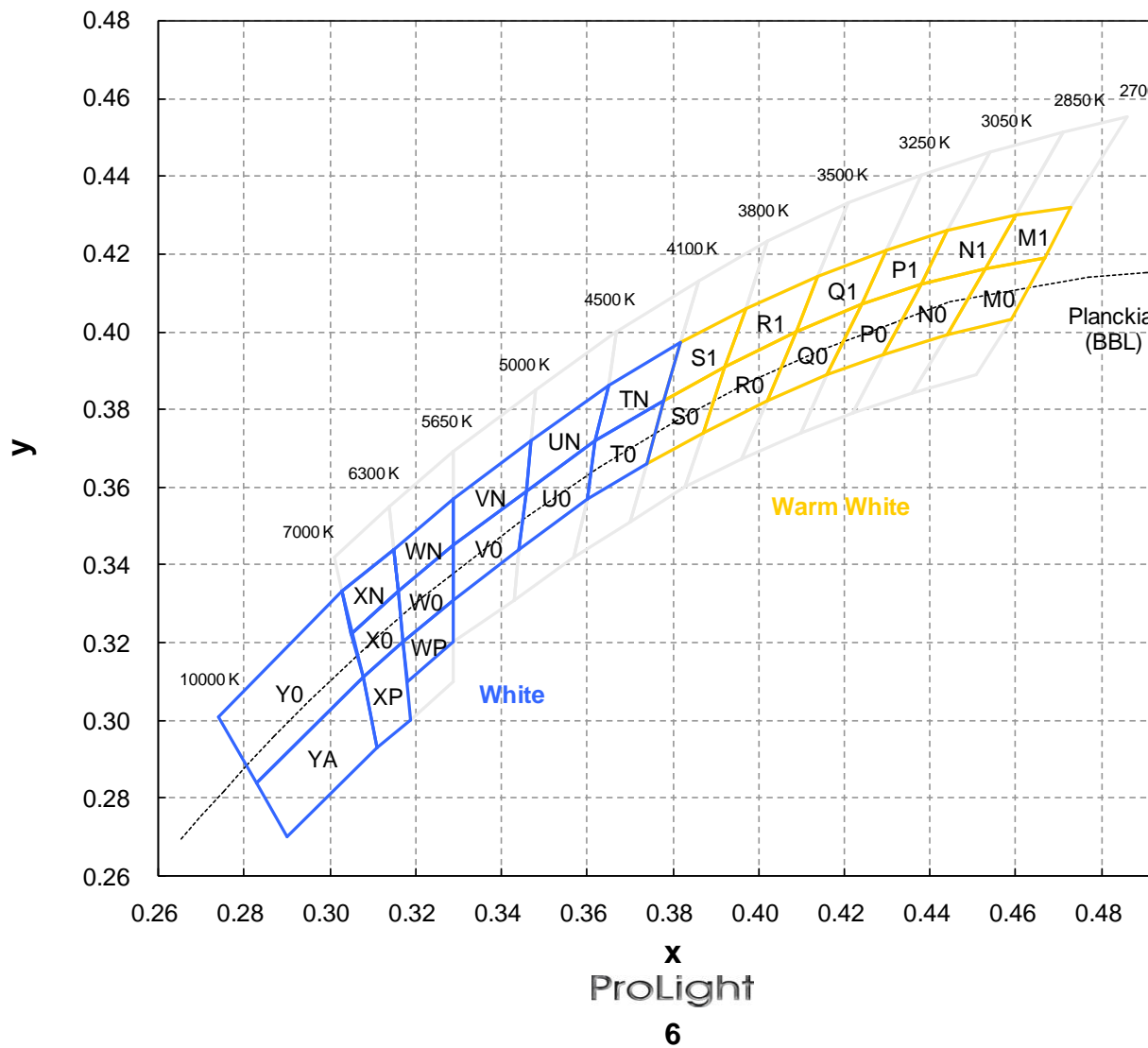

Color Bins

White Bin Structure

Bin Code	x	y	Typ. CCT (K)	Bin Code	x	y	Typ. CCT (K)
T0	0.378	0.382	4300	WN	0.329	0.345	5970
	0.374	0.366			0.316	0.333	
	0.360	0.357			0.315	0.344	
	0.362	0.372			0.329	0.357	
TN	0.382	0.397	4300	WP	0.329	0.331	5970
	0.378	0.382			0.329	0.320	
	0.362	0.372			0.318	0.310	
	0.365	0.386			0.317	0.320	
U0	0.362	0.372	4750	X0	0.308	0.311	6650
	0.360	0.357			0.305	0.322	
	0.344	0.344			0.316	0.333	
	0.346	0.359			0.317	0.320	
UN	0.365	0.386	4750	XN	0.305	0.322	6650
	0.362	0.372			0.303	0.333	
	0.346	0.359			0.315	0.344	
	0.347	0.372			0.316	0.333	
V0	0.329	0.331	5320	XP	0.308	0.311	6650
	0.329	0.345			0.317	0.320	
	0.346	0.359			0.319	0.300	
	0.344	0.344			0.311	0.293	
VN	0.329	0.345	5320	Y0	0.308	0.311	8000
	0.329	0.357			0.283	0.284	
	0.347	0.372			0.274	0.301	
	0.346	0.359			0.303	0.333	
W0	0.329	0.345	5970	YA	0.308	0.311	8000
	0.329	0.331			0.311	0.293	
	0.317	0.320			0.290	0.270	
	0.316	0.333			0.283	0.284	

- Tolerance on each color bin (x , y) is ± 0.01

Note: Although several bins are outlined, product availability in a particular bin varies by production run and by product performance. Not all bins are available in all colors.

Color Bins

Warm White Bin Structure

Bin Code	x	y	Typ. CCT (K)	Bin Code	x	y	Typ. CCT (K)
M0	0.453	0.416	2770	Q0	0.409	0.400	3370
	0.444	0.399			0.402	0.382	
	0.459	0.403			0.416	0.389	
	0.467	0.419			0.424	0.407	
M1	0.460	0.430	2770	Q1	0.414	0.414	3370
	0.453	0.416			0.409	0.400	
	0.467	0.419			0.424	0.407	
	0.473	0.432			0.430	0.421	
N0	0.438	0.412	2950	R0	0.392	0.391	3650
	0.429	0.394			0.387	0.374	
	0.444	0.399			0.402	0.382	
	0.453	0.416			0.409	0.400	
N1	0.444	0.426	2950	R1	0.414	0.414	3650
	0.438	0.412			0.409	0.400	
	0.453	0.416			0.392	0.391	
	0.460	0.430			0.397	0.406	
P0	0.424	0.407	3150	S0	0.392	0.391	3950
	0.416	0.389			0.387	0.374	
	0.429	0.394			0.374	0.366	
	0.438	0.412			0.378	0.382	
P1	0.430	0.421	3150	S1	0.397	0.406	3950
	0.424	0.407			0.392	0.391	
	0.438	0.412			0.378	0.382	
	0.444	0.426			0.382	0.397	

- Tolerance on each color bin (x , y) is ± 0.01

Note: Although several bins are outlined, product availability in a particular bin varies by production run and by product performance. Not all bins are available in all colors.

Peak Wavelength Bin Structure

Color	Bin Code	Minimum Peak Wavelength (nm)	Maximum Peak Wavelength (nm)
Cherry Red	1	720	740

- ProLight maintains a tolerance of ± 1 nm for peak wavelength measurements.

Dominant Wavelength Bin Structure

Color	Bin Code	Minimum Dominant Wavelength (nm)	Maximum Dominant Wavelength (nm)
Red	2	613.5	620.5
	4	620.5	631.0
Amber	2	587.0	589.5
	4	589.5	592.0
	6	592.0	594.5
	7	594.5	597.0
Green	A	515	520
	1	520	525
	2	525	530
	3	530	535
Cyan	A	495	500
	1	500	505
	2	505	510
	3	510	515
Blue	A	455	460
	1	460	465
	2	465	470
	3	470	475
Royal Blue	5	450	455
	6	455	460

- ProLight maintains a tolerance of ± 1 nm for dominant wavelength measurements.

Note: Although several bins are outlined, product availability in a particular bin varies by production run and by product performance. Not all bins are available in all colors.

Color Spectrum, $T_J = 25^\circ\text{C}$

1. White

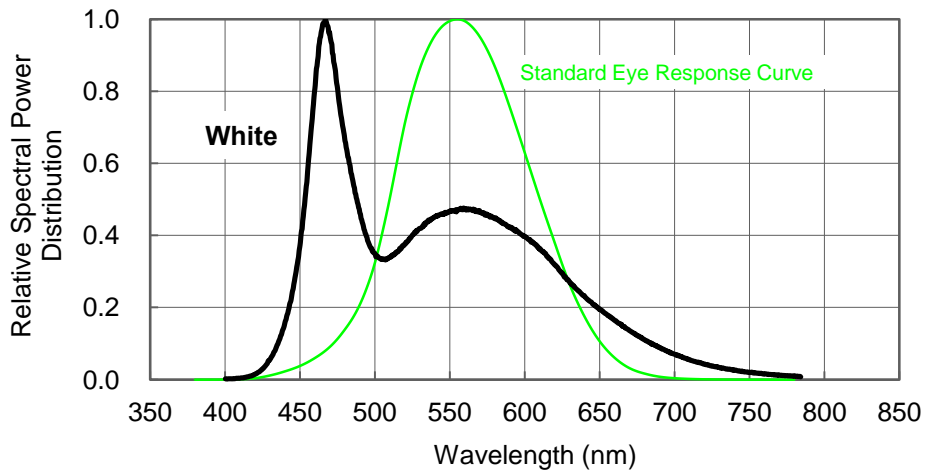

2. Warm White

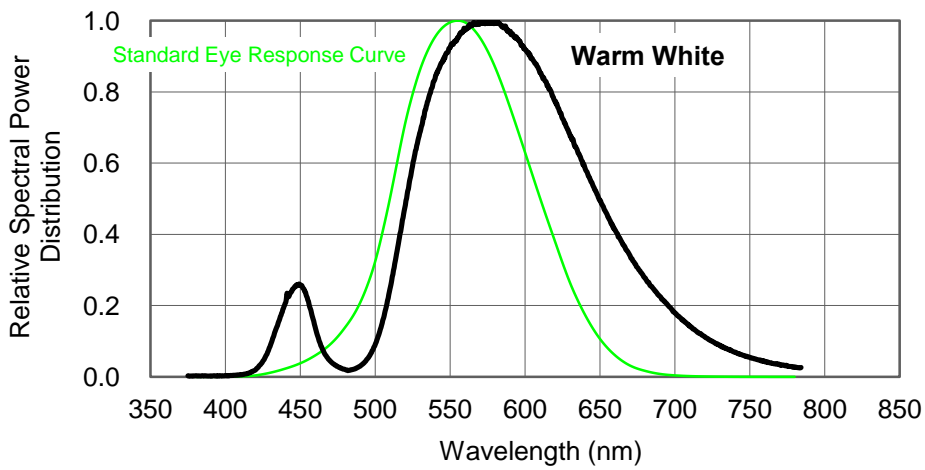

3. Royal Blue 、 Blue 、 Cyan 、 Green 、 Amber 、 Red 、 Cherry Red

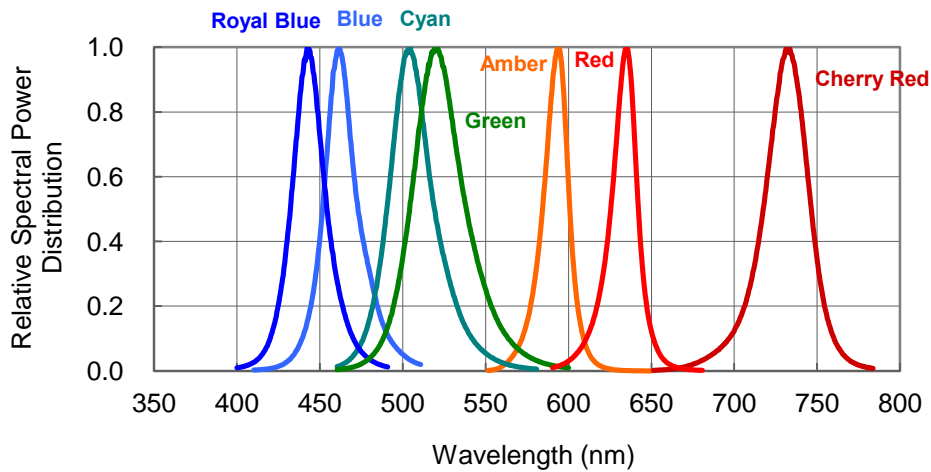

ProLight

Light Output Characteristics

Relative Light Output vs. Junction Temperature at 350mA

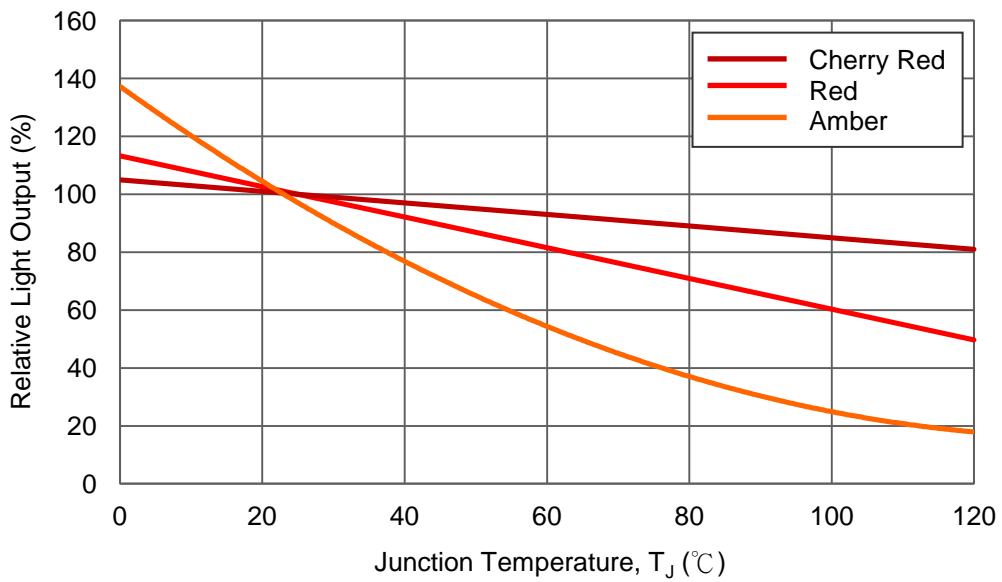
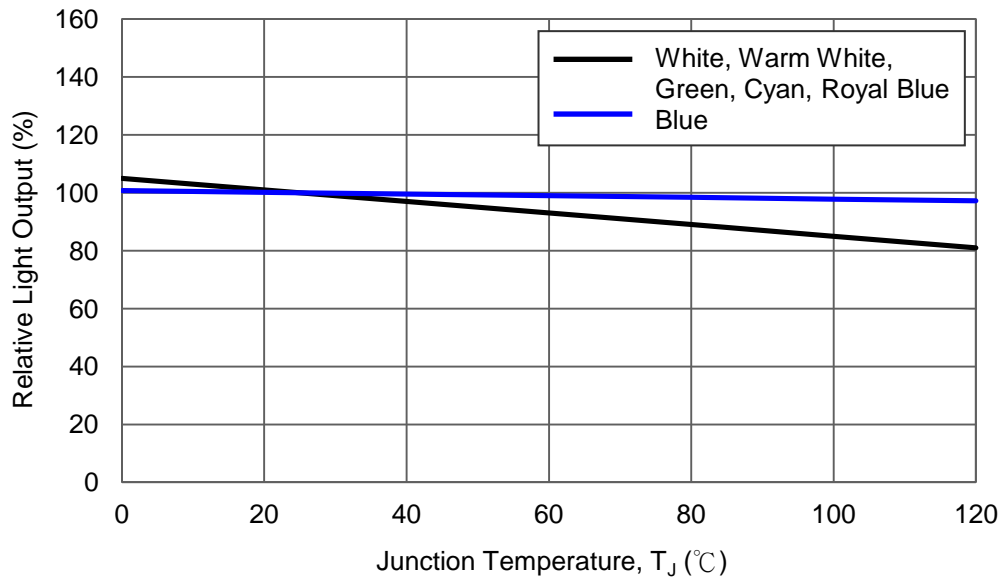

Forward Current Characteristics, $T_J = 25^\circ\text{C}$

1. Forward Voltage vs. Forward Current

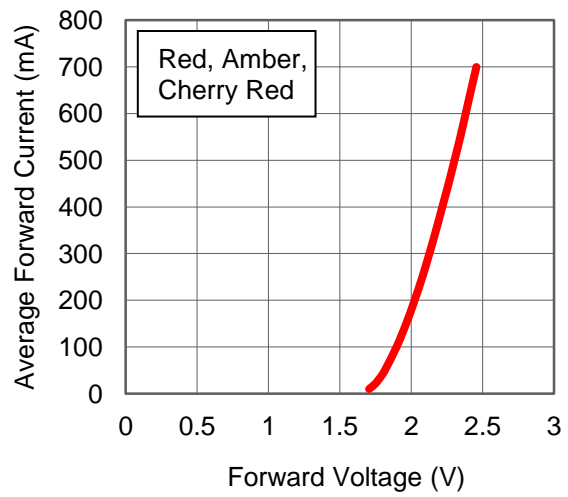
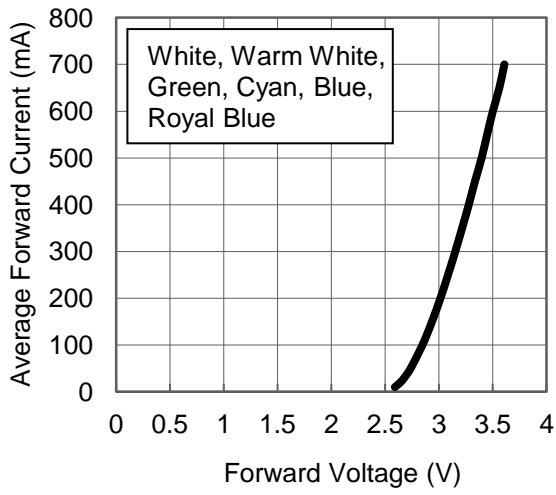

2. Forward Current vs. Normalized Relative Luminous Flux

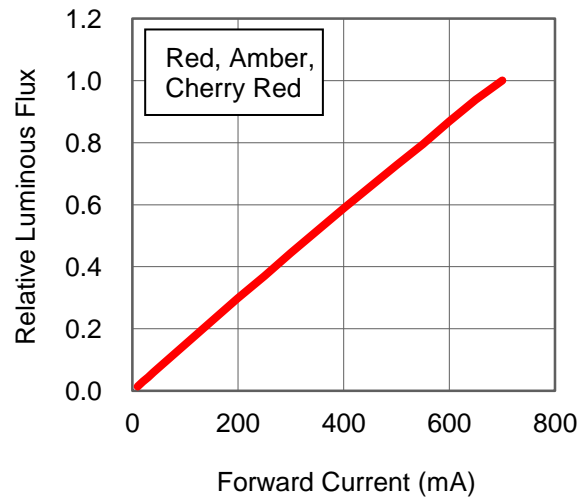
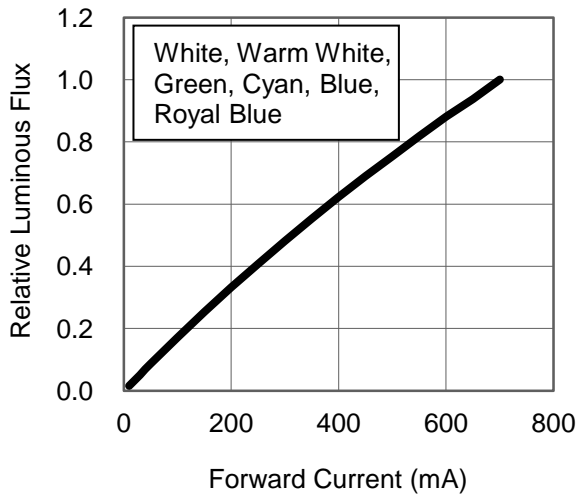

Ambient Temperature vs. Maximum Forward Current

1. White, Warm White, Green, Cyan, Blue, Royal Blue ($T_{JMAX} = 120^{\circ}C$)

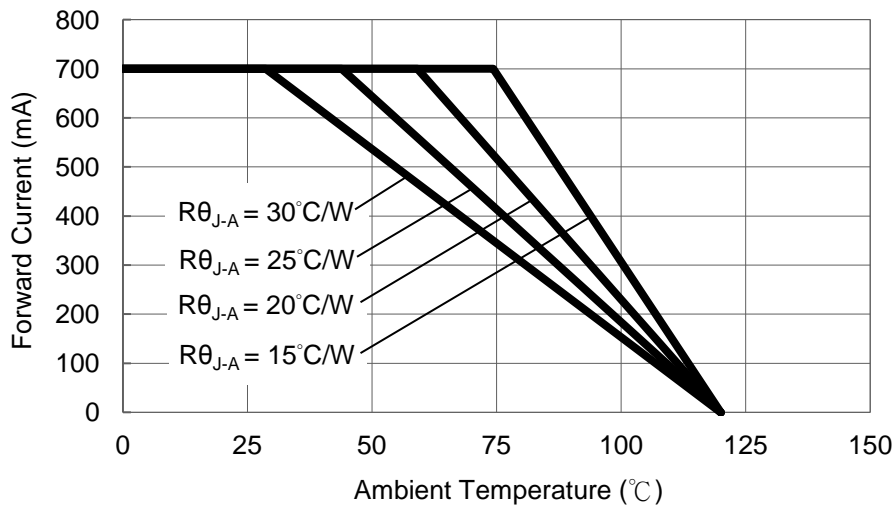

2. Red, Amber, Cherry Red ($T_{JMAX} = 120^{\circ}C$)

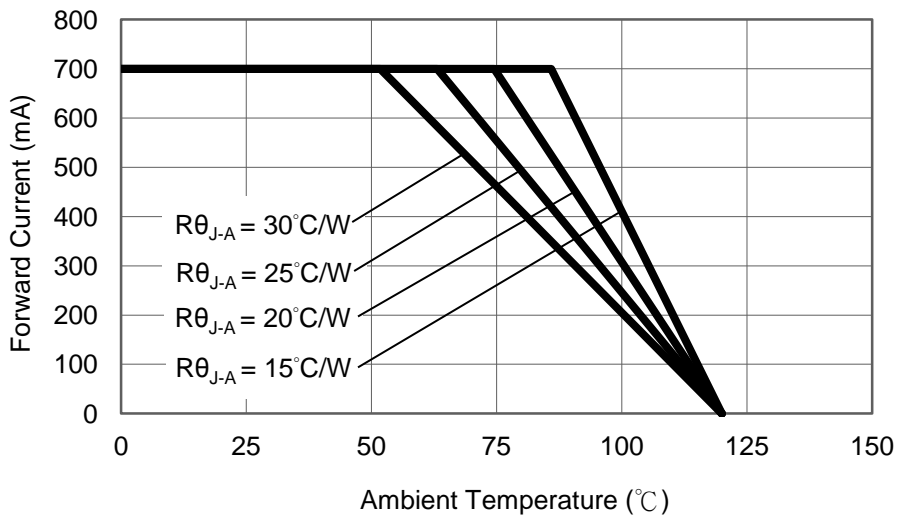

Typical Representative Spatial Radiation Pattern

Lambertian Radiation Pattern

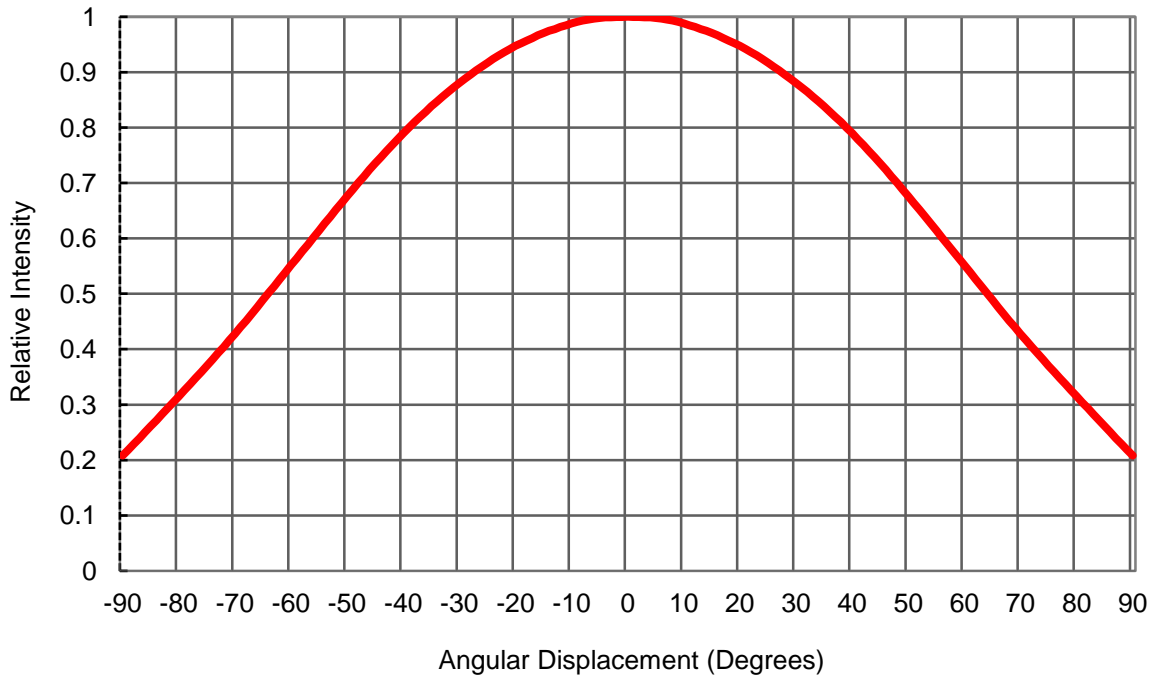

Qualification Reliability Testing

Stress Test	Stress Conditions	Stress Duration	Failure Criteria
Room Temperature Operating Life (RTOL)	25°C, $I_F = \text{max DC}$ (Note 1)	1000 hours	Note 2
Wet High Temperature Operating Life (WHTOL)	85°C/60%RH, $I_F = \text{max DC}$ (Note 1)	1000 hours	Note 2
Wet High Temperature Storage Life (WHTSL)	85°C/85%RH, non-operating	1000 hours	Note 2
High Temperature Storage Life (HTSL)	110°C, non-operating	1000 hours	Note 2
Low Temperature Storage Life (LTSL)	-40°C, non-operating	1000 hours	Note 2
Non-operating Temperature Cycle (TMCL)	-40°C to 120°C, 30 min. dwell, <5 min. transfer	200 cycles	Note 2
Non-operating Thermal Shock (TMSK)	-40°C to 120°C, 20 min. dwell, <20 sec. transfer	200 cycles	Note 2
Mechanical Shock	1500 G, 0.5 msec. pulse, 5 shocks each 6 axis		Note 3
Natural Drop	On concrete from 1.2 m, 3X		Note 3
Variable Vibration Frequency	10-2000-10 Hz, log or linear sweep rate, 20 G about 1 min., 1.5 mm, 3X/axis		Note 3

Notes:

1. Depending on the maximum derating curve.
2. Criteria for judging failure

Item	Test Condition	Criteria for Judgement	
		Min.	Max.
Forward Voltage (V_F)	$I_F = \text{max DC}$	--	Initial Level x 1.1
Luminous Flux or Radiometric Power (Φ_V)	$I_F = \text{max DC}$	Initial Level x 0.7	--
Reverse Current (I_R)	$V_R = 5V$	--	50 μA

* The test is performed after the LED is cooled down to the room temperature.

3. A failure is an LED that is open or shorted.

Star Tube Packaging

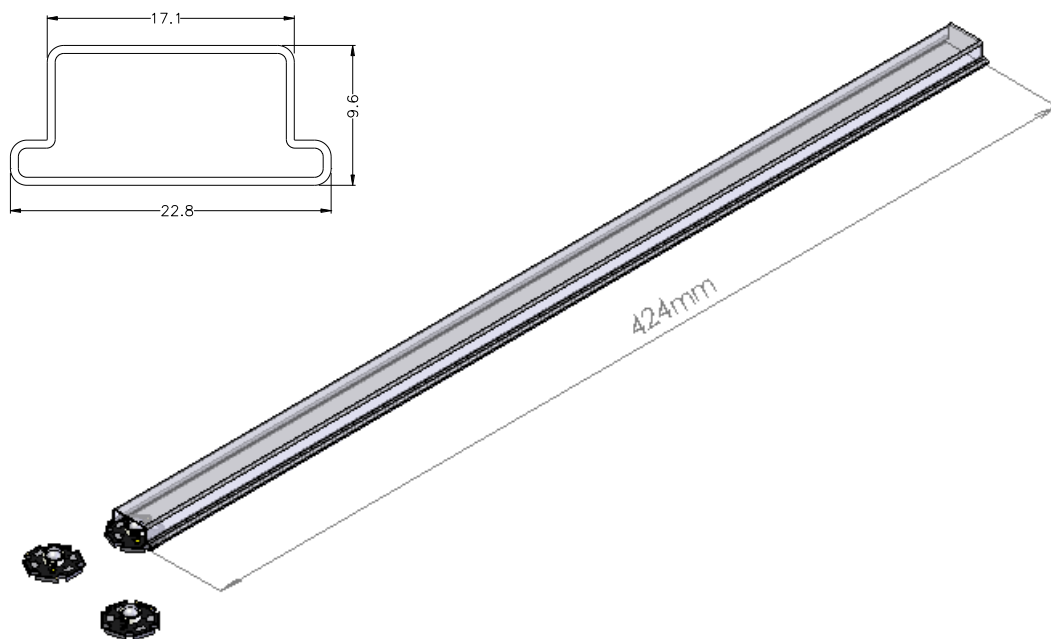

Notes:

1. 20 pieces per tube.
2. Drawing not to scale.
3. All dimensions are in millimeters.
4. All dimensions without tolerances are for reference only.

**Please do not open the moisture barrier bag (MBB) more than one week. This may cause the leads of LED discoloration. We recommend storing ProLight's LEDs in a dry box after opening the MBB. The recommended storage conditions are temperature 5 to 30°C and humidity less than 40% RH.

Precaution in Handling

- The modules light output are intense enough to cause injury to human eyes if viewed directly. Precautions must be taken to avoid looking directly at the modules with unprotected eyes.
- Chemical solvents or cleaning agents must not be used to clean the modules. Mechanical stress on the Emitters must be avoided. It is best to use a soft brush, damp cloth or low-pressure compressed air.
- The products should be stored away from direct light in dry location.
- The appearance, specifications and flux bin of the product may be modified for improvement without notice. Please refer to the below website for the latest datasheets.
<http://www.prolightopto.com/>

X-ON Electronics

Largest Supplier of Electrical and Electronic Components

Click to view similar products for [High Power LEDs - Multi-Colour category:](#)

Click to view products by [Prolight manufacturer:](#)

Other Similar products are found below :

[CLQ6A-TKW-S1L1R1H1QBB7935CC3](#) [CLQ6A-TKW-S1L1R1H1QBB7935AA3](#) [LL-HP60NUYC](#) [OSB4XME3E1E](#) [OSB5XZE1E1E](#)
[OSG5XDE5E1E](#) [OSR5XAE1E1E](#) [OSR5XAE3E1E](#) [OSR5XME1E1E](#) [PC8N-10LTS-C](#) [PC8N-5LTS-C](#) [PK2N-3LAE-SD](#) [PK2N-3LRE-SD](#)
[PM2B-3LGS-SD](#) [PQ2A-4FGE](#) [PQ2A-4FPE-YGFC](#) [PQ2A-4FWE-FC](#) [OSTCXBEAC1E](#) [PM2E-1LAE](#) [PM2E-1LAS](#) [PM2E-1LGS](#) [PM2E-1LRS](#)
[PM2E-3LAE-SD](#) [PM2E-3LAS-SD](#) [PM2E-3LBS-SD](#) [PM2E-3LGS-SD](#) [PM2E-3LRE-SD](#) [PP6N-TFFE-D60](#) [PP6N-FFFE-D60](#) [PP6N-3LFE](#)
[PP6N-1LFE-P](#) [PK2N-3LLE-L](#) [PBLA-10LTE](#) [PC8N-10LTE-VRGB](#) [OSB4XDE5E1E](#) [OSB4XME1E1E](#) [OSG5XME1E1E](#)
[OSR5XAT1C1E](#) [OSR5XAT3C1E](#) [OSR5XDE5E1E](#) [OSR5XME3E1E](#) [OSY5XAE3E1E](#) [OSY5XAT3C1E](#) [OSY5XME3E1E](#) [PC8N-10LTE-C](#)
[PC8N-5L4E-C](#) [PK2N-3LBE-SD](#) [PM2B-1LBE](#) [PM2B-1LPE-M](#) [PM2B-1LPS-M](#)