

Wire Wound Inductor - Ceramic Or Ferrite Base

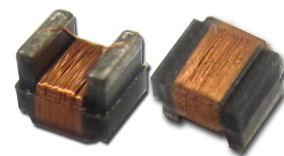

2.92 x 2.79 x 2.29mm

AISC-1008(F)



RoHS/RoHS II Compliant

FEATURES:

- Ceramic or Ferrite Construction assures the utmost in the thermal stability and high SRF
- Exceptionally high Q compared to non-wirewound inductor, especially at high frequencies
- Inductance values available from 4.7 nH to 10,000nH

APPLICATIONS:

- Widely applied in the VCO, SAW circuit for GSM, CDMA communications
- Used in hard disk, notebook computer and other electronic equipment

STANDARD SPECIFICATIONS:

Part Number AISC-1008- Inductance Code	Inductance	Tolerance	Min. Quality Factor	L/Q Test Freq.	Max. DC Resistance	Max. Rated Current	Min. Self-resonant Frequency
Units	nH	-	-	MHz	Ω	mA	MHz
Symbol	L	-	Q	Freq.	DCR	I _r	S.R.F
AISC-1008-R0047	4.7	J, K, M	50	50/1500	0.11	1000	>6000
AISC-1008-R010	10	G, J, K, M	50	50/500	0.08	1000	4100
AISC-1008-R012	12	G, J, K, M	50	50/500	0.09	1000	3300
AISC-1008-R015	15	G, J, K, M	50	50/500	0.13	1000	2500
AISC-1008-R018	18	G, J, K, M	50	50/350	0.11	1000	2500
AISC-1008-R022	22	G, J, K, M	55	50/350	0.12	1000	2400
AISC-1008-R027	27	G, J, K, M	55	50/350	0.13	1000	1600
AISC-1008-R033	33	G, J, K, M	60	50/350	0.14	1000	1600
AISC-1008-R039	39	G, J, K, M	50	50/350	0.15	1000	1500
AISC-1008-R047	47	G, J, K, M	65	50/350	0.16	1000	1500
AISC-1008-R056	56	G, J, K, M	50	50/350	0.18	1000	1300
AISC-1008-R068	68	G, J, K, M	65	50/350	0.21	1000	1200
AISC-1008-R082	82	G, J, K, M	60	50/350	0.22	1000	800
AISC-1008-R10	100	G, J, K, M	60	25/350	0.56	650	1000
AISC-1008-R12	120	G, J, K, M	60	25/350	0.63	650	950
AISC-1008-R15	150	G, J, K, M	50	25/100	0.62	580	800
AISC-1008-R18	180	G, J, K, M	50	25/100	0.7	620	750
AISC-1008-R22	220	G, J, K, M	50	25/100	0.8	500	630
AISC-1008-R27	270	G, J, K, M	50	25/100	0.91	500	600
AISC-1008-R33	330	G, J, K, M	50	25/100	1.05	450	530
AISC-1008-R39	390	G, J, K, M	50	25/100	1.12	470	480
AISC-1008-R47	470	G, J, K, M	50	25/100	1.19	470	450
AISC-1008-R56	560	G, J, K, M	50	25/100	1.33	400	390
AISC-1008-R62	620	G, J, K, M	45	25/100	1.4	300	375
AISC-1008-R68	680	G, J, K, M	45	25/100	1.47	400	360
AISC-1008-R75	750	G, J, K, M	45	25/100	1.54	360	360
AISC-1008-R82	820	G, J, K, M	45	25/100	1.61	400	330
AISC-1008-R91	910	G, J, K, M	35	25/50	1.68	380	295
AISC-1008-1R0	1,000	G, J, K, M	35	25/50	1.8	370	270
AISC-1008-1R2	1,200	G, J, K, M	35	7.9/50	2	310	200
AISC-1008-1R5	1,500	G, J, K, M	28	7.9/50	2.3	330	150
AISC-1008-1R8	1,800	G, J, K, M	28	7.9/50	2.6	300	120
AISC-1008-2R2	2,200	G, J, K, M	28	7.9/50	2.8	280	100
AISC-1008-2R7	2,700	G, J, K, M	22	7.9/25	3.2	290	90
AISC-1008-3R3	3,300	G, J, K, M	22	7.9/25	3.4	290	70
AISC-1008-3R9	3,900	G, J, K, M	17	7.9/25	3.6	260	60
AISC-1008-4R7	4,700	G, J, K, M	20	7.9/25	4	260	50
AISC-1008-5R6	5,600	G, J, K, M	20	7.9/25	5.7	240	40
AISC-1008-6R8	6,800	G, J, K, M	20	7.9/25	7.7	200	40
AISC-1008-8R2	8,200	G, J, K, M	20	7.9/25	10.7	150	30

ABRACON IS
ISO 9001 :2008
CERTIFIED



ABRACON
CORPORATION

Visit www.abracon.com for Terms & Conditions of Sale

30332 Esperanza, Rancho Santa Margarita, California 92688
tel 949-546-8000 | fax 949-546-8001 | www.abracon.com

Revised: 09.17.13

Wire Wound Inductor - Ceramic Or Ferrite Base

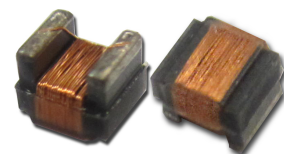

2.92 x 2.79 x 2.29mm

AISC-1008(F)



RoHS/RoHS II Compliant

Part Number AISC-1008F- Inductance Code	Inductance	Tolerance	Min. Quality Factor	L/Q Test Freq.	Max. DC Resistance	Max. Rated Current	Min. Self-resonant Frequency
Units	nH	-	-	MHz	Ω	mA	MHz
Symbol	L	-	Q	Freq.	DCR	Ir	S.R.F
AISC-1008F-R33	330	J, K, M	50	25/100	0.17	700	600
AISC-1008F-1R0	1,000	J, K, M	20	7.9/50	0.80	600	250
AISC-1008F-1R2	1,200	J, K, M	37	7.9/50	0.80	650	250
AISC-1008F-1R5	1,500	J, K, M	35	7.9/50	0.76	630	190
AISC-1008F-1R8	1,800	J, K, M	33	7.9/50	0.84	600	170
AISC-1008F-2R2	2,200	J, K, M	30	7.9/50	1.15	520	150
AISC-1008F-2R7	2,700	J, K, M	25	7.9/50	1.30	490	120
AISC-1008F-3R3	3,300	J, K, M	23	7.9/50	1.70	450	100
AISC-1008F-3R9	3,900	J, K, M	26	7.9/25	2.00	420	100
AISC-1008F-4R7	4,700	J, K, M	31	7.9/7.9	1.68	400	60
AISC-1008F-5R6	5,600	J, K, M	23	7.9/7.9	2.65	380	80
AISC-1008F-6R8	6,800	J, K, M	20	7.9/7.9	3.00	360	60
AISC-1008F-8R2	8,200	J, K, M	20	7.9/7.9	3.30	330	40
AISC-1008F-100	10,000	J, K, M	15	7.9/7.9	2.95	300	40

Test Conditions and Equipemt

- Ambient Temperature: 20± 15°C
- Relative Humidity: 65%±20%
- Air Pressure: 86KPa to 106KPa

Inductance (L): Agilent4287A+Agilent16197A or equivalent, -13dBm or 10mA

Direct Current Resistance (DCR): HIOKI 3540 or equivalent

Q Factor (Q): Agilent4287A+Agilent16197A or equivalent, -13dBm or 10mA

Self-Resonant Frequency (SRF): Agilent4991B+Agilent16197A and HP 8753E or equivalent, -20dBm or 50mV

Rated Current (Ir): Ir is direct electric current as chip surface temperature rose just 20°C against chip initial surface temperature (Ta)

Operating Temperature: -40°C to +125°C for AISC-1008, -40°C to +85°C for AISC-1008F

Storage Temperature: -10°C to +40°C, 70% RH max.

Wire Wound Inductor - Ceramic Or Ferrite Base

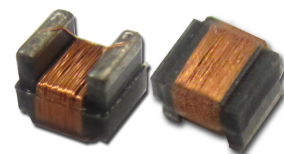

2.92 x 2.79 x 2.29mm

AISC-1008(F)



RoHS/RoHS II Compliant

ELECTRICAL CHARACTERISTICS CURVES :

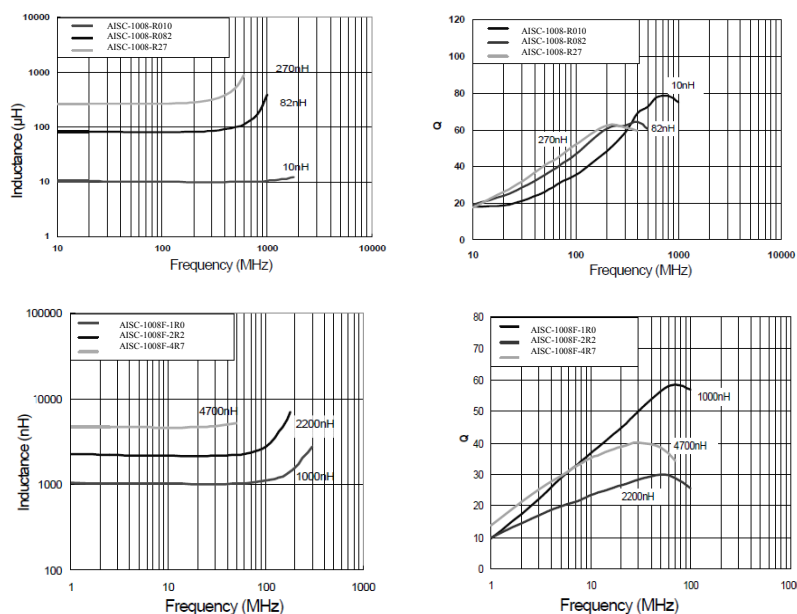

PART IDENTIFICATION:

AISC-1008 - -

Material Code	Inductance Code	Tolerance Code	Packaging
Blank: Ceramic	Please refer to the table	G: ±2%	T: Tape & Reel (2k/reel)
F: Ferrite		J: ±5%	
		K: ±10%	
		M: ±20%	

OUTLINE DIMENSIONS:

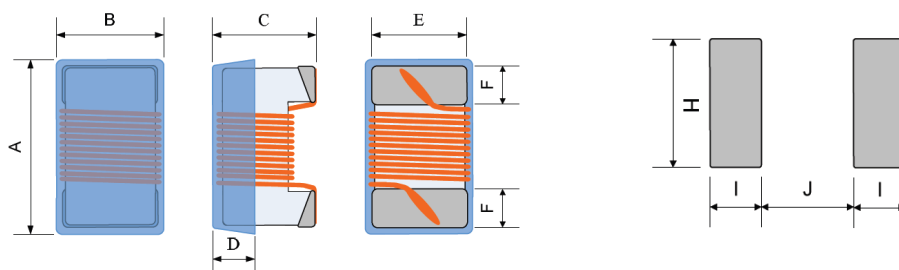

A MAX.	B MAX.	C MAX.	D REF.	E	F	H REF.	I REF.	J REF.
2.92	2.79	2.29	0.51	2.1±0.2	0.5±0.2	2.54	1.02	1.27

Dimension: mm

ABRACON IS
ISO 9001 :2008
CERTIFIED



Visit www.abracon.com for Terms & Conditions of Sale
30332 Esperanza, Rancho Santa Margarita, California 92688
tel 949-546-8000 | fax 949-546-8001 | www.abracon.com

Revised: 09.17.13

Wire Wound Inductor - Ceramic Or Ferrite Base

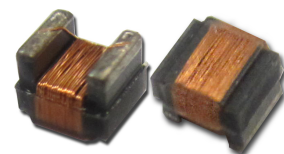

2.92 x 2.79 x 2.29mm

AISC-1008(F)



RoHS/RoHS II Compliant

Materials

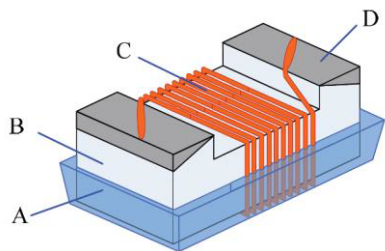

No.	Components	Material
A	Coating	Ultraviolet epoxy resin
B	Core	Ceramic
C	Wire	Polyurethane system enameled copper wire
D	Electrodes	AISC-1008: Mo-Mn with Ni and Au plating AISC-1008F: Ag-Pd with Ni-Sn plating

REFLOW PROFILE:

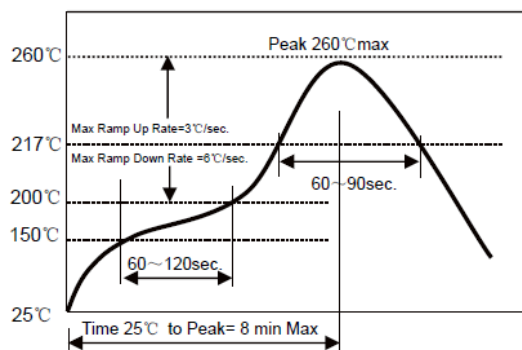

- Δ 1~2 °C/sec. Ramp
- Δ Pre-heating: 150~190°C /90±30 sec.
- Δ Time above 240 °C: 20~40sec
- Δ Peak temperature: 260 °C Max./10sec;
- Δ Solder paste: Sn/3.0Ag/0.5Cu
- Δ Max.2 times for Re-flowing

TAPE & REEL: 2kpcs /Reel

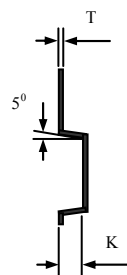
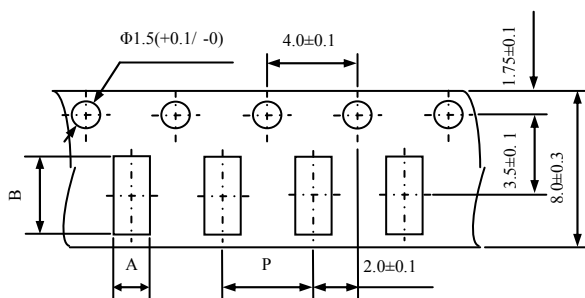

A	P	B	K Max	T
2.73±0.2	4.0±0.1	2.90±0.2	2.34±0.2	0.23±0.1

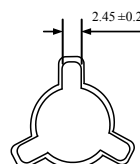
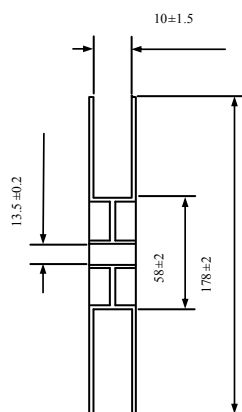
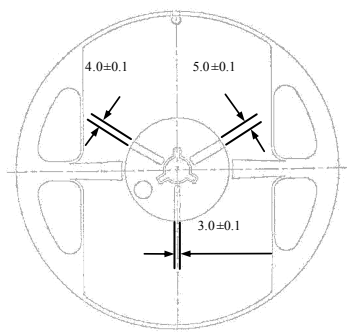

ATTENTION: Abracon Corporation's products are COTS – Commercial-Off-The-Shelf products; suitable for Commercial, Industrial and, where designated, Automotive Applications. Abracon's products are not specifically designed for Military, Aviation, Aerospace, Life-dependant Medical applications or any application requiring high reliability where component failure could result in loss of life and/or property. For applications requiring high reliability and/or presenting an extreme operating environment, written consent and authorization from Abracon Corporation is required. Please contact Abracon Corporation for more information.

ABRACON IS
ISO 9001 :2008
CERTIFIED



ABRACON
CORPORATION

Visit www.abracon.com for Terms & Conditions of Sale

Revised: 09.17.13

30332 Esperanza, Rancho Santa Margarita, California 92688
tel 949-546-8000 | fax 949-546-8001 | www.abracon.com

X-ON Electronics

Largest Supplier of Electrical and Electronic Components

Click to view similar products for [Fixed Inductors](#) category:

Click to view products by [ABRACON](#) manufacturer:

Other Similar products are found below :

[MLZ1608M6R8WTD25](#) [MLZ1608N6R8LT000](#) [MLZ1608N3R3LTD25](#) [MLZ1608N3R3LT000](#) [MLZ1608N150LT000](#)
[MLZ1608M150WTD25](#) [MLZ1608M3R3WTD25](#) [MLZ1608M3R3WT000](#) [MLZ1608M150WT000](#) [MLZ1608A1R5WT000](#)
[MLZ1608N1R5LT000](#) [B82432C1333K000](#) [PCMB053T-1R0MS](#) [PCMB053T-1R5MS](#) [PCMB104T-1R5MS](#) [CR32NP-100KC](#) [CR32NP-151KC](#) [CR32NP-180KC](#) [CR32NP-181KC](#) [CR32NP-1R5MC](#) [CR32NP-390KC](#) [CR32NP-3R9MC](#) [CR32NP-680KC](#) [CR32NP-820KC](#)
[CR32NP-8R2MC](#) [CR43NP-390KC](#) [CR43NP-560KC](#) [CR43NP-680KC](#) [CR54NP-181KC](#) [CR54NP-470LC](#) [CR54NP-820KC](#) [CR54NP-8R5MC](#)
[MGDQ4-00004-P](#) [MGDU1-00016-P](#) [MHL1ECTTP18NJ](#) [MHL1JCTTD12NJ](#) [PE-51506NL](#) [PE-53601NL](#) [PE-53630NL](#) [PE-53824SNLT](#) [PE-62892NL](#) [PE-92100NL](#) [PG0434.801NLT](#) [PG0936.113NLT](#) [PM06-2N7](#) [PM06-39NJ](#) [HC2LP-R47-R](#) [HC2-R47-R](#) [HC3-2R2-R](#) [HC8-1R2-R](#)