

5 V, SUPER MINIMOLD WIDEBAND SI RFIC AMPLIFIER

FEATURES

- **HIGH DENSITY SURFACE MOUNTING:**
6 pin super minimold or SOT-363 package
- **HIGH GAIN:** 15 dB TYP
- **SATURATED OUTPUT POWER:** +10 dBm
- **WIDEBAND RESPONSE:** $f_u = 2.9$ GHz TYP
- **SUPPLY VOLTAGE:** $V_{CC} = 4.5$ to 5.5 V

DESCRIPTION

The UPC2708TB is a Silicon RFIC manufactured using the NESAT III process. This device is suitable as buffer amplifier for DBS, PCS and other communication receivers. The UPC2708TB is pin compatible and has comparable performance as the larger UPC2708T, so it is suitable for use as a replacement to help reduce system size. The IC is housed in a 6 pin super minimold or SOT-363 package.

Stringent quality assurance and test procedures ensure the highest reliability and performance.

GAIN vs.
FREQUENCY and TEMPERATURE

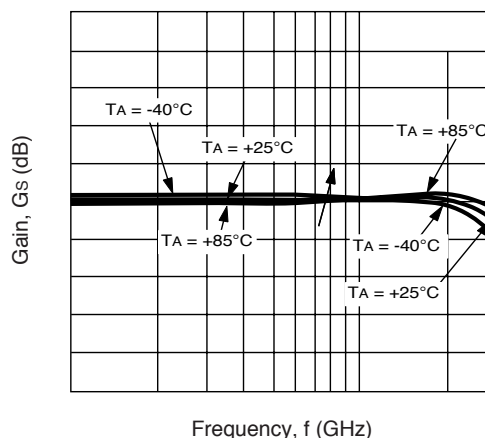

ELECTRICAL CHARACTERISTICS ($T_A = 25^\circ\text{C}$, $f = 1$ GHz, $V_{CC} = 5$ V)

PART NUMBER PACKAGE OUTLINE			UPC2708TB S06		
SYMBOLS	PARAMETERS AND CONDITIONS	UNITS	MIN	TYP	MAX
I_{CC}	Circuit Current (no signal)	mA	20	26	33
G_s	Small Signal Gain	dB	13	15	18.5
f_u	Upper Limit Operating Frequency (The gain at f_u is 3 dB down from the gain at 0.1 GHz)	GHz	2.7	2.9	
ΔG_s	Gain Flatness, $f = 0.1 - 2.6$ GHz	dB		± 0.8	
P_{SAT}	Saturated Output Power	dBm	+7.5	+10	
P_{1dB}	Output Power at 1 dB Compression Point	dBm		+7.5	
NF	Noise Figure	dB		6.5	8
RL_{IN}	Input Return Loss	dB	8	11	
RL_{OUT}	Output Return Loss	dB	16	20	
ISOL	Isolation	dB	18	23	
ΔG_T	Gain-Temperature Coefficient	dB/ $^\circ\text{C}$		+0.002	
R_{TH}	Thermal Resistance (Junction to Ambient)	$^\circ\text{C}/\text{W}$			325

ABSOLUTE MAXIMUM RATINGS¹ (TA = 25°C)

SYMBOLS	PARAMETERS	UNITS	RATINGS
VCC	Supply Voltage	V	6
PIN	Input Power	dBm	+10
PT	Power Dissipation ²	mW	200
TOP	Operating Temperature	°C	-40 to +85
TSTG	Storage Temperature	°C	-55 to +150

Notes:

1. Operation in excess of any one of these parameters may result in permanent damage.
2. Mounted on 50 x 50 x 1.6 mm epoxy glass PWB (TA = +85°C).

RECOMMENDED OPERATING CONDITIONS

SYMBOL	PARAMETER	UNITS	MIN	TYP	MAX
VCC	Supply Voltage	V	4.5	5.0	5.5

TYPICAL PERFORMANCE CURVES (TA = 25°C)

CIRCUIT CURRENT vs. VOLTAGE

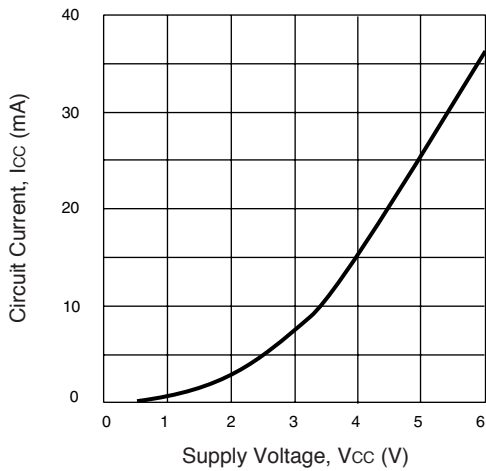

CIRCUIT CURRENT vs. TEMPERATURE

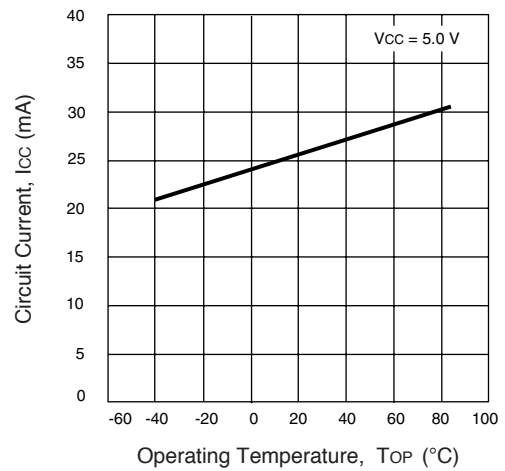

GAIN AND NOISE FIGURE vs. FREQUENCY AND VOLTAGE

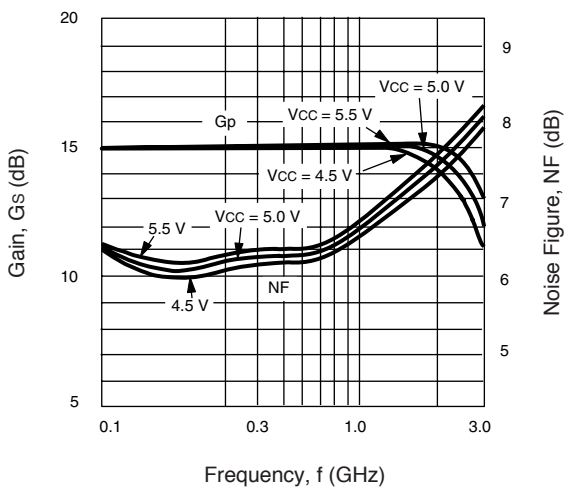

INPUT RETURN LOSS, OUTPUT RETURN LOSS vs. FREQUENCY

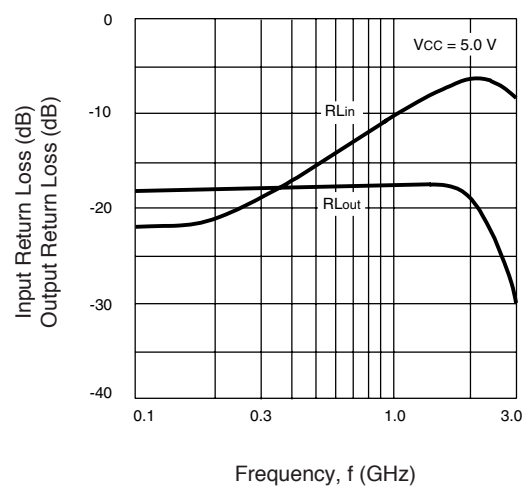

TYPICAL PERFORMANCE CURVES (TA = 25°C)

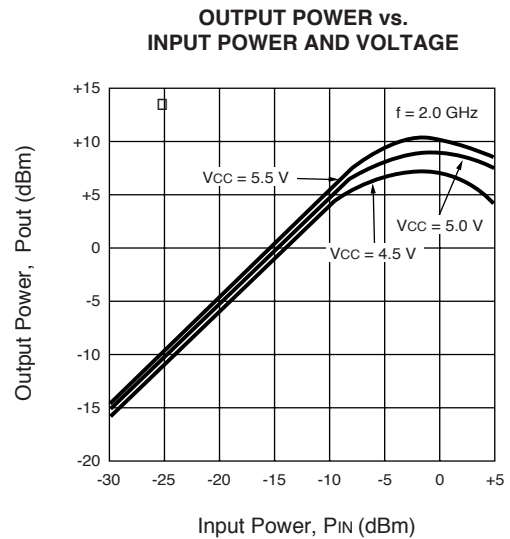
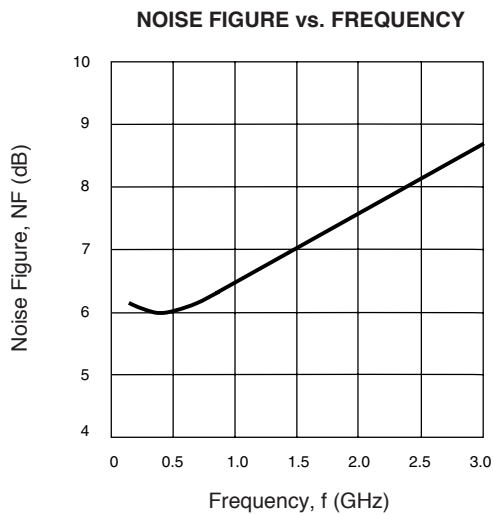
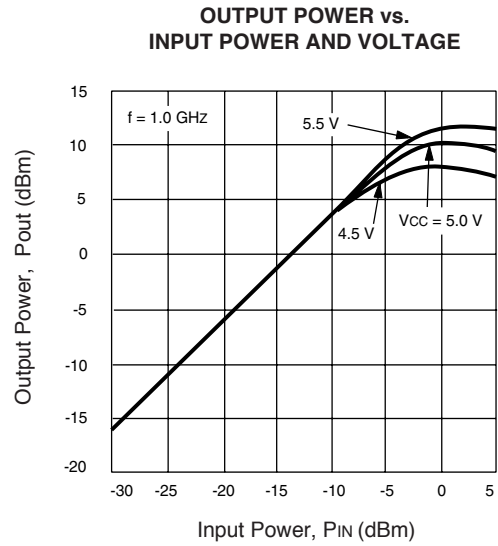
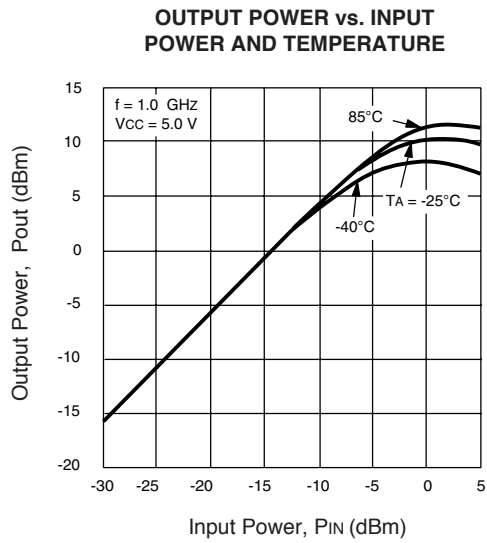
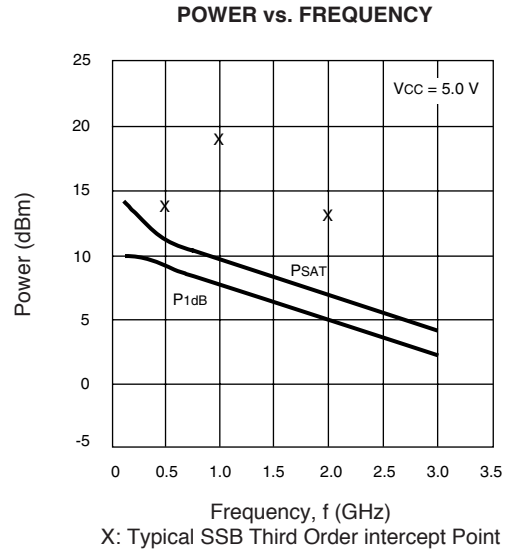
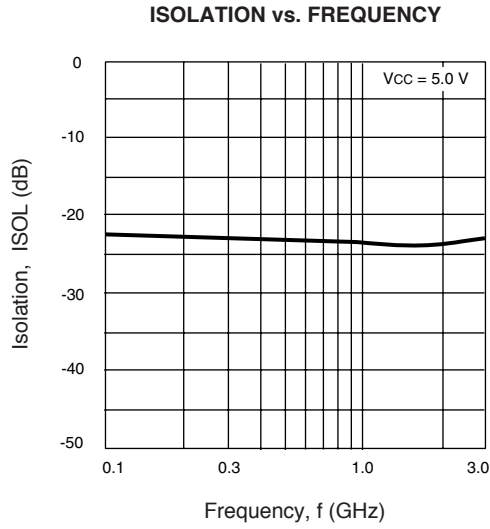

TYPICAL PERFORMANCE CURVES (T_A = 25°C)

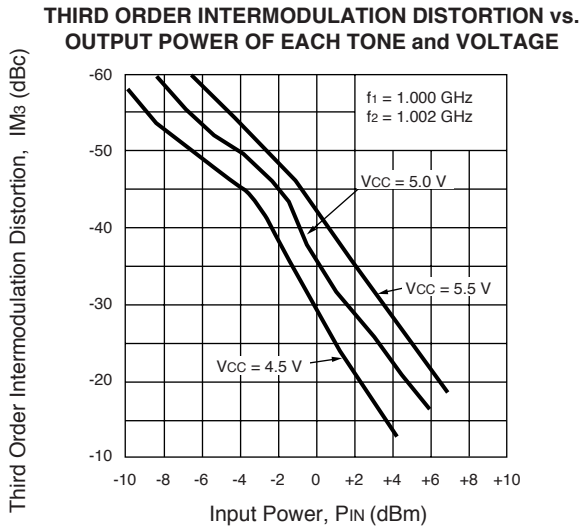
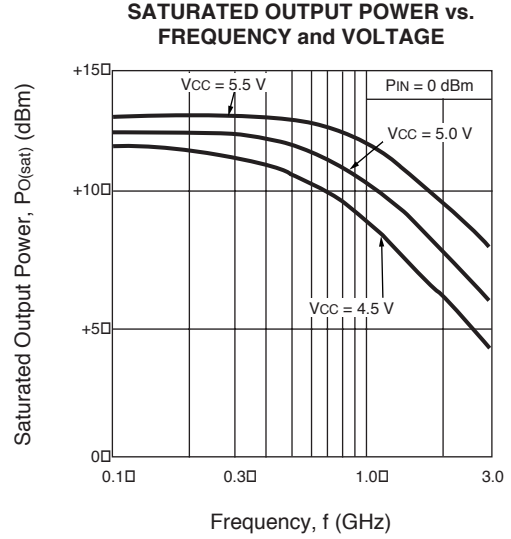
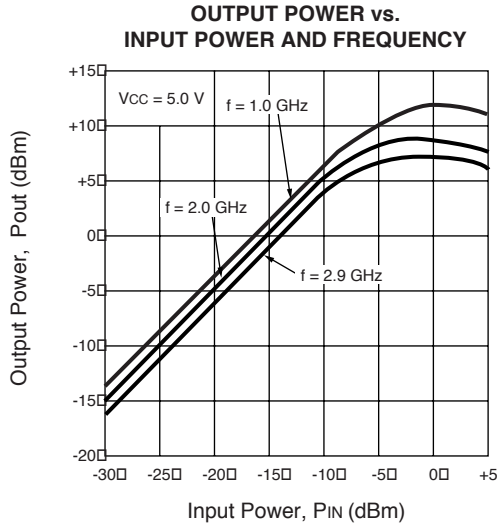

TYPICAL SCATTERING PARAMETERS ($T_A = 25^\circ\text{C}$, $V_{CC} = V_{OUT} = 5.0\text{ V}$)

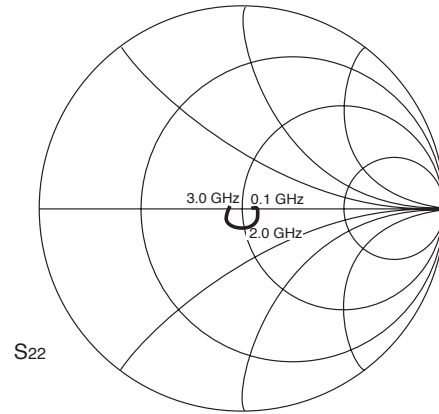
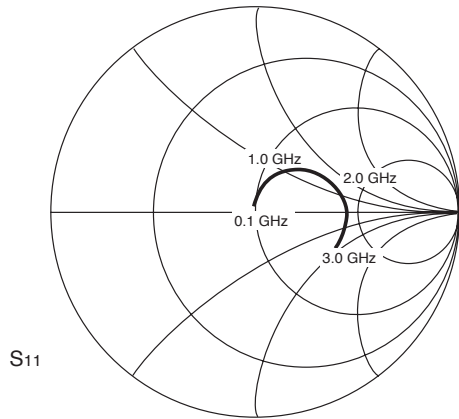

UPC2708TB

$V_{CC} = V_{OUT} = 5\text{ V}$, $I_{CC} = 27\text{ mA}$

FREQUENCY GHz	S11		S21		S12		S22		K
	MAG	ANG	MAG	ANG	MAG	ANG	MAG	ANG	
0.1	0.039	138.9	5.815	-4.8	0.077	-0.8	0.051	0.9	1.34
0.2	0.053	119.7	5.822	-9.8	0.075	-1.5	0.048	1.4	1.36
0.3	0.069	106.7	5.815	-14.3	0.074	-0.6	0.049	5.9	1.38
0.4	0.088	97.2	5.813	-18.8	0.074	-0.5	0.054	8.9	1.36
0.5	0.105	91.6	5.794	-23.8	0.072	-1.1	0.054	8.8	1.39
0.6	0.123	84.9	5.823	-28.4	0.071	-0.6	0.056	10.4	1.40
0.7	0.144	79.7	5.871	-33.0	0.070	0.1	0.060	11.5	1.40
0.8	0.164	74.7	5.890	-38.2	0.071	0.5	0.065	11.6	1.37
0.9	0.186	70.7	5.938	-42.8	0.073	2.3	0.072	11.1	1.34
1.0	0.205	66.1	5.960	-47.6	0.070	4.4	0.082	5.6	1.31
1.1	0.226	61.7	6.072	-52.7	0.069	5.0	0.091	-4.6	1.28
1.2	0.245	57.7	6.097	-57.5	0.070	4.4	0.082	5.6	1.31
1.3	0.263	53.7	6.174	-63.0	0.067	2.5	0.085	0.6	1.33
1.4	0.286	48.6	6.275	-68.4	0.069	5.0	0.091	-4.6	1.28
1.5	0.308	44.3	6.371	-74.3	0.070	5.4	0.092	-8.2	1.24
1.6	0.328	40.7	6.419	-79.8	0.066	7.1	0.097	-12.6	1.26
1.7	0.344	36.2	6.470	-85.9	0.067	5.6	0.096	-19.6	1.23
1.8	0.364	31.0	6.555	-92.1	0.069	8.2	0.100	-23.9	1.18
1.9	0.382	26.0	6.542	-98.3	0.070	8.4	0.092	-8.2	1.24
2.0	0.395	21.2	6.570	-104.7	0.070	8.7	0.101	-38.9	1.13
2.1	0.405	16.8	6.528	-111.3	0.070	10.1	0.100	-47.2	1.12
2.2	0.417	11.8	6.527	-118.5	0.071	9.4	0.096	-57.2	1.09
2.3	0.427	6.6	6.438	-124.7	0.072	9.5	0.098	-66.1	1.09
2.4	0.431	2.2	6.336	-131.3	0.071	10.7	0.095	-76.5	1.09
2.5	0.431	-3.0	6.247	-138.1	0.072	12.8	0.098	-86.1	1.09
2.6	0.434	-8.2	6.127	-145.0	0.071	15.4	0.094	-99.9	1.10
2.7	0.423	-12.3	5.952	-151.7	0.071	14.5	0.088	-116.7	1.14
2.8	0.419	-17.1	5.816	-158.2	0.070	16.1	0.081	-134.4	1.18
2.9	0.408	-21.5	5.619	-165.0	0.073	15.3	0.074	-149.7	1.19
3.0	0.400	-26.2	5.354	-171.5	0.074	17.1	0.065	-170.3	1.24
3.1	0.386	-29.3	5.134	-177.4	0.075	17.1	0.053	172.8	1.28

PIN DESCRIPTIONS

Pin No.	Symbol	Applied Voltage (V)	Pin Voltage (V)	Description	Internal Equivalent Circuit
1	Input	–	1.16	Signal input pin. An internal matching circuit, configured with resistors, enables 50 Ω connection over a wide bandwidth. A multi-feedback circuit is designed to cancel the deviations of hFE and resistance. This pin must be coupled to the signal source with a blocking capacitor.	
4	Output	–	–	Signal output pin. Connect an inductor between this pin and Vcc to supply current to the internal output transistors.	
6	Vcc	4.5 to 5.5	–	Power supply pin. This pin should be externally equipped with a bypass capacitor to minimize ground impedance.	
2 3 5	GND	0	–	Ground pins. These pins should be connected to system ground with minimum inductance. Ground pattern on the board should be formed as wide as possible. All the ground pins must be connected together with wide ground pattern to minimize impedance difference.	

SYSTEM APPLICATION EXAMPLE

EXAMPLE OF DBS CONVERTERS

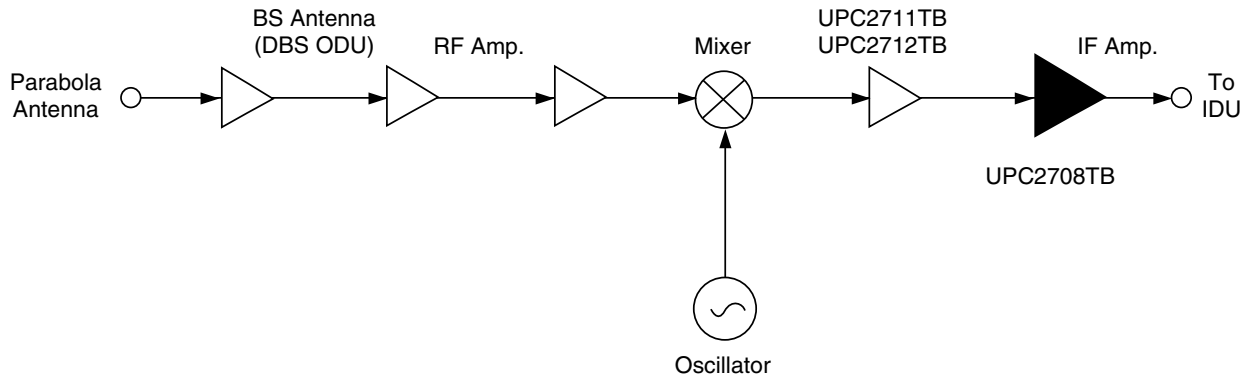

EXAMPLE OF 2.4 GHz BAND RECEIVER

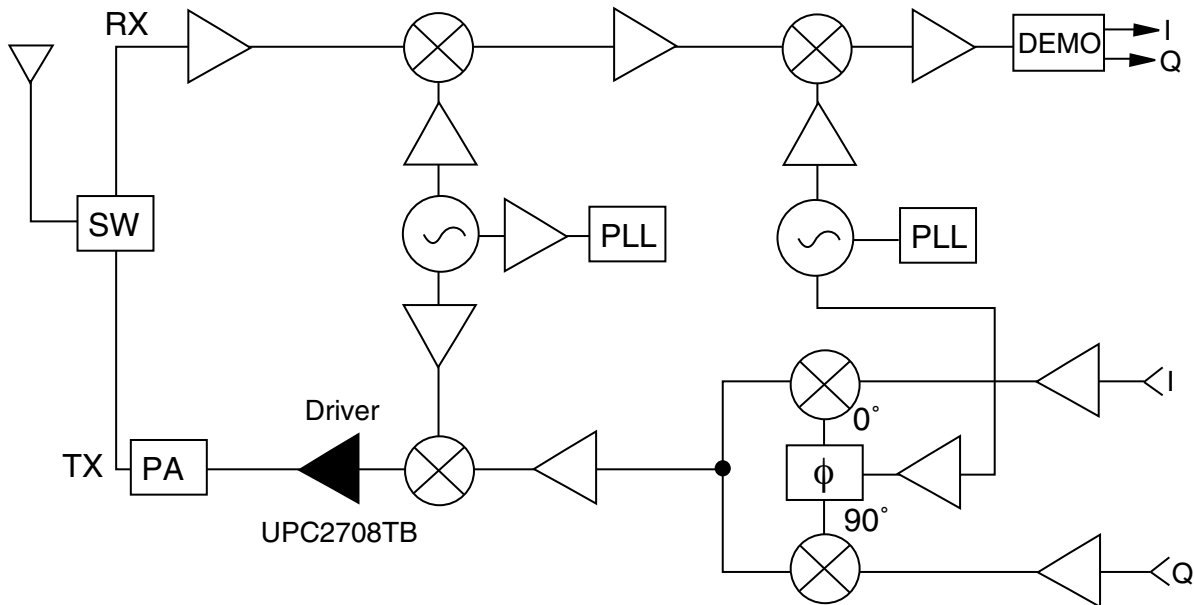

OUTLINE DIMENSIONS (Units in mm)

PACKAGE OUTLINE S06
(Top View)

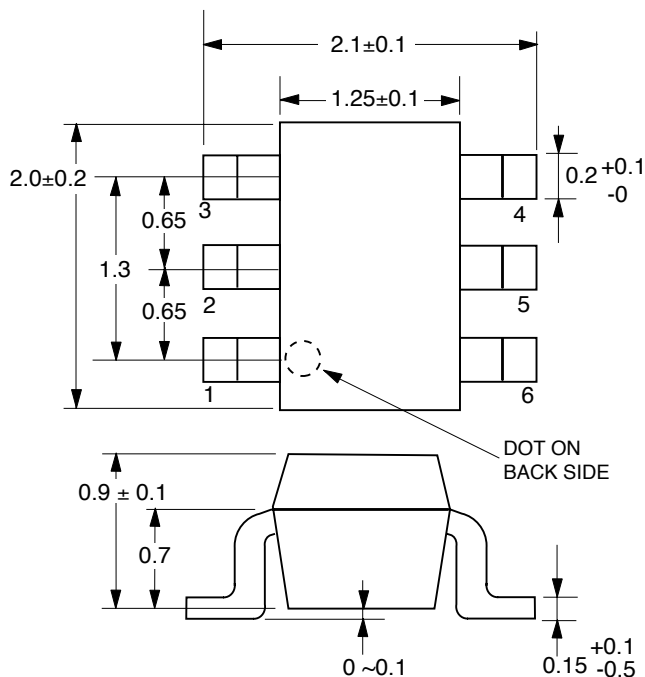

ORDERING INFORMATION

PART NUMBER	MARKING	QTY
UPC2708TB-E3-A	C1D	3K/Reel

Note:
Embossed Tape, 8 mm wide. Pins 1, 2 and 3 face perforated side of tape.

TEST CIRCUIT

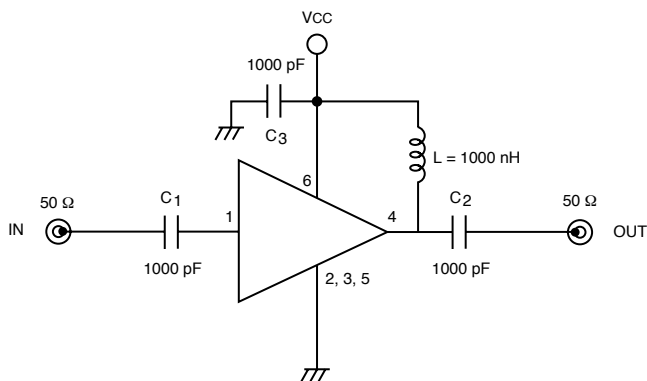

PIN CONNECTIONS

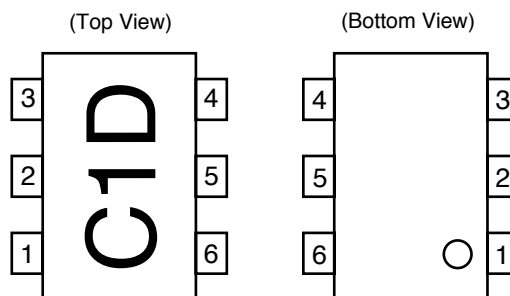

- 1. INPUT
- 2. GND
- 3. GND
- 4. OUTPUT
- 5. GND
- 6. VCC

X-ON Electronics

Largest Supplier of Electrical and Electronic Components

Click to view similar products for [Prescaler category](#):

Click to view products by [CEL manufacturer](#):

Other Similar products are found below :

[UXD20P](#) [UXN14M9P](#) [MX1DS10P](#) [UXC20P](#) [UXN14M32K](#) [2089-6208-00](#) [2089-6408-00](#) [HMC492LP3TR](#) [HMC434TR](#) [HMC433TR](#)
[HMC394LP4TR](#) [HMC862ALP3E](#) [HMC434SRJZ-EP-PT](#) [ADMV2101BRHZ](#) [HMC361G8TR](#) [HMC705LP4ETR](#) [HMC362S8G](#) [HMC361G8](#)
[HMC361S8G](#) [HMC361S8GETR](#) [HMC362S8GE](#) [HMC363G8](#) [HMC363S8G](#) [HMC363S8GE](#) [HMC363S8GETR](#) [HMC365](#) [HMC365G8](#)
[HMC365S8GE](#) [HMC365S8GETR](#) [HMC394LP4E](#) [HMC394LP4ETR](#) [HMC432](#) [HMC432E](#) [HMC432ETR](#) [HMC433](#) [HMC433E](#)
[HMC433ETR](#) [HMC434E](#) [HMC434ETR](#) [HMC437MS8G](#) [HMC437MS8GE](#) [HMC438MS8G](#) [HMC438MS8GE](#) [HMC438MS8GETR](#)
[HMC447LC3](#) [HMC447LC3TR](#) [HMC492LP3ETR](#) [HMC492LP3](#) [HMC492LP3E](#) [HMC493LP3E](#)