



TH032

CONNESSIONE LINEARE COMPATTA. 4+4 POLI.
COMPACT LINEAR TERMINAL BLOCK. 4+4 POLES.

TH032

new

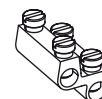
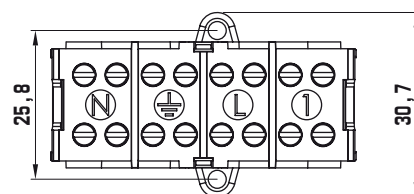
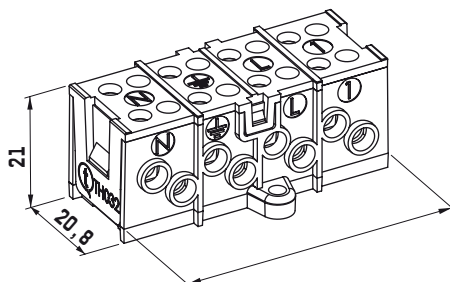

CE RoHS

Dimensioni in millimetri. *Dimensions shown in millimetres.*

Dati generali *General data*

Dati tecnici *Technical data*

N. poli	4+4	<i>N. poles</i>
Terminali	vite/perforazione <i>screw/piercing</i>	<i>Terminals</i>
Sezione cavo	max 4.0 mm ² (bussola STD STD terminals) 0.5 mm ² - 1.5 mm ² (bussola a perforazione <i>piercing clip terminals</i>)	<i>Cable section</i>
Grado di protezione (IP)	IP00	<i>Degree of protection (IP)</i>
Corrente e tensione nominale	32A 450V (bussola STD STD terminals) 17.5A 450V (bussola a perforazione <i>piercing clip terminals</i>)	<i>Rated current and voltage</i>
T marking	T125°C	<i>T marking</i>
Temperatura di funzionamento	-40°C to +125°C	<i>Operating temperature</i>
Indice di tracking	PTI 175	<i>Tracking index</i>

Materie prime *Raw materials*

Corpo plastico morsetteria	PA66 GF UL94 V0 GWT 960°C marrone <i>brown</i>	<i>Terminal block housing</i>
Bussole	ottone nichelato <i>brass nickel plated</i>	<i>Contact screw terminals</i>
Viti standard	M3 acciaio zincato passivato <i>steel zinc plated</i>	<i>Standard screws</i>
Viti perforazione	M3 acciaio zincato ottonato <i>steel zinc brass plated</i>	<i>Piercing screws</i>

Norme *Standards*

EN60998-1:2005
EN60998-2-1:2005
EN60998-2-3:2005

Eventuali modifiche e migliorie sui dati tecnici o sul prodotto potranno essere effettuate senza preavviso.
All technical data or other eventual product modifications and improvements can be carried out without notice.





TH032

CONNESSIONE LINEARE COMPATTA. 4+4 POLI.
COMPACT LINEAR TERMINAL BLOCK. 4+4 POLES.

TH032

Codice Order number

versione version	n. poli n. poles	bussola contact terminal	pz/imb pcs/box	codice order number
	4+4		400	THB.032.A4B
	4+4		400	THP.032.A4B

Note: Bussola doppia max 4.0 mm² Multiple contact max 4.0 mm² Bussola a perforazione max 1.5 mm² Piercing clip terminals max 1.5 mm²

Varianti Options

Colore Colour Contatta il Servizio Clienti per maggiori informazioni. Contact our Customer Service for availability.

versione version	codice order number
<input type="checkbox"/> altri colori other colours	THX.032.XXX.CX

Kit di fornitura Purchasing kit

versione version	misure imballaggio box dimensions	contenuto contents	pz/imb (1) pcs/box	codice order number
kit standard standard kit	C05 (395x395x185 mm)		400	THX.032.XXX
kit imbustato retail pack kit Consulta il catalogo Rivenditori. See the Retailers catalogue.	--		--	THX.032.XXX.R
versione speciale custom version	*	*	*	THX.032.XXX.K

Note: (1) Le quantità minime ordinabili possono variare se acquistati con scatole TEEBOX®.
Minimum order quantity can vary when purchased as an integral component of TEEBOX® articles.

Note: Per maggiori informazioni sulle istruzioni di assemblaggio consulta www.techno.it.
For more information about assembling instructions see www.techno.it.

* Sono possibili personalizzazioni di prodotto e progetti su richieste specifiche. Contatta il Servizio Clienti.
Personalization and new custom products are possible. Please contact our Customer Service.

Eventuali modifiche e migliorie sui dati tecnici o sul prodotto potranno essere effettuate senza preavviso.
All technical data or other eventual product modifications and improvements can be carried out without notice.



Caratteristiche e vantaggi *Features and benefits*

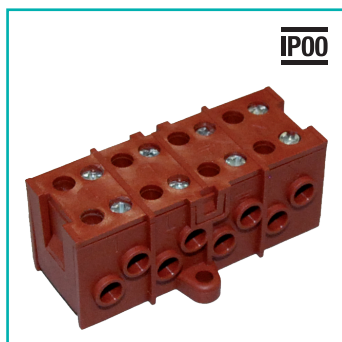

IP00

Morsettiere distributore di corrente
2+2/3+3 poli di dimensioni compatte.
Current distributor terminal block
2+2/3+3 poles with compact size.

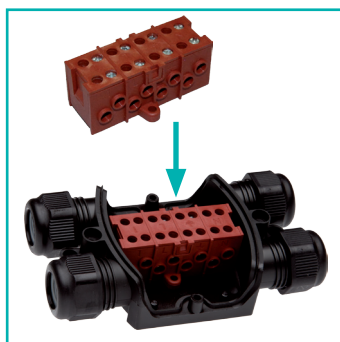

Soluzioni modulari: morsettiere utilizzabile singolarmente o all'interno di giunti TEEBOX® per una connessione protetta.
Modular design can be used as stand-alone terminal block or installed into TEEBOX® products to achieve a waterproof connection.

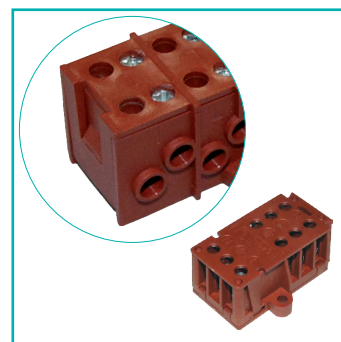

Soluzioni affidabili. L'involucro esterno aumenta l'isolamento della connessione ed evita il contatto con le parti attive.
Reliable solutions. The external shell increases the protection grade and avoids accidental contact with active parts.

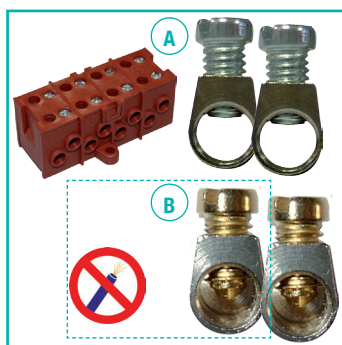

Inserti disponibili in versione:
A) passante, B) perforazione di isolante.
Metal inserts available:
A) pass-through, B) piercing clip terminals.



Riduzione dei tempi di installazione.
Cablaggio veloce a perforazione di isolante: inserire il cavo senza spelare la guaina e avvitare la vite di colore oro.
Time saving installation. Piercing clip terminal block: insert the cable and tighten the gold colour screw without stripping the sheath.

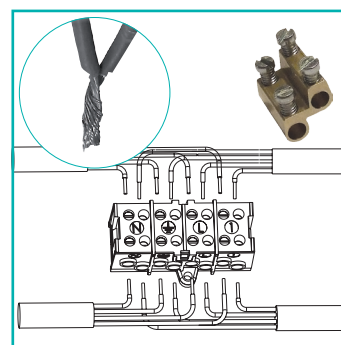

Innovazione di prodotto Cablaggio rapido di derivazioni 4+4 poli. Si evita di attorcigliare il trefolo.
Product innovation. Fast wiring of electrical derivations (4+4 poles). Avoid twisting the top of the wire.

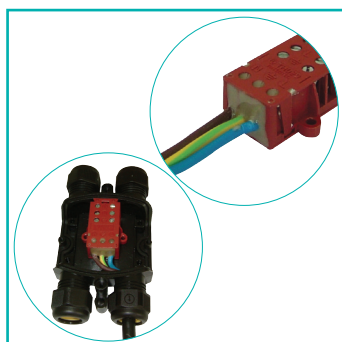

Protezione dalla condensa con resina ad alto potere isolante, garantisce l'integrità degli apparecchi nel tempo.
Protection from moisture condensation with a special resin with excellent insulation capacity, ensures integrity of equipments over the time.

X-ON Electronics

Largest Supplier of Electrical and Electronic Components

Click to view similar products for [hylec manufacturer](#):

Other Similar products are found below :

[LN167001](#) [50.625 PA/3X7](#) [50.620 PA/R](#) [DESTB-1003](#) [THB.406.A1G](#) [THB.387.A4A.R](#) [K150-1032-00](#) [GHG9601955R0004](#) [K151-1032-00](#)
[HYKS-07612PP](#) [THB.382.A1A-KIT](#) [THB.390.A1AKIT](#) [THK.404.X2A00-F](#) [50.216 ES](#) [50.616M/EMVDL-F](#) [50.625 ES](#) [PA244SKIT](#)
[THB.387.A3A](#) [THB.405.A2A](#) [50.220 M-F](#) [HY435/12 FV](#) [THB110A6B-F](#) [50.216 M-F](#) [THB.387.B5A](#) [5625////1121](#) [THB.380.3ASSY](#)
[THB.405.A2G](#) [THA.209.A1A](#) [DESTB-1002](#) [THB.384.A1A](#) [K257-1012-00](#) [6000302CC](#) [TTK25BK-SD-F](#) [TTK20GY-SD-F](#) [DESTB-0403](#)
[THB.384.B1A](#) [50.625 PA/RSW](#) [HY508/3 V/3F](#) [5665/221](#) [THB.387.D4A](#) [THB.387.B4A](#) [THR.405.S5A](#) [THB.381.M2A](#) [THB.387.A5A](#)
[THB.387.C5A](#) [THB.387.D3A](#) [50.625 M/EMVDL-F](#) [THK.200.3T](#) [THB.381.A2A](#) [K160-1040-00](#)