

* = Conical form tapering downward.
 Untoleranced dimensions per DIN 16901-140

OPTIONAL ACCESSORIES

PART NAME	QTY.	AVAILABILITY
MOUNTING PLATE	1	Y
EXTERNAL HINGE	-	N
INTERNAL HINGE	-	N
MOUNTING BRACKETS	4	Y
NEOPRENE/EMC/SILICON GASKET	1	Y
DIN RAIL TS15	1	Y
DIN RAIL TS35	-	N

Cylinder Screw
 M4 x 24/7 similar to DIN 94

SECTION A-A

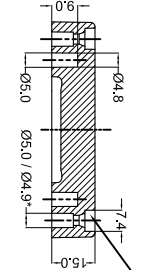

SECTION A-A

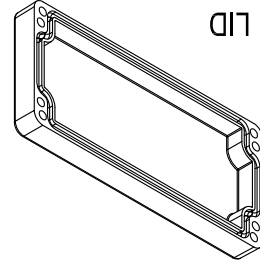
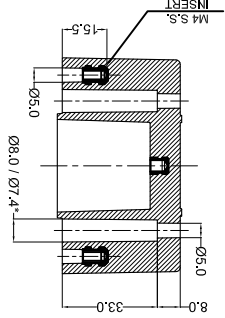

LID

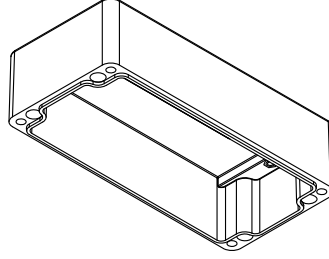
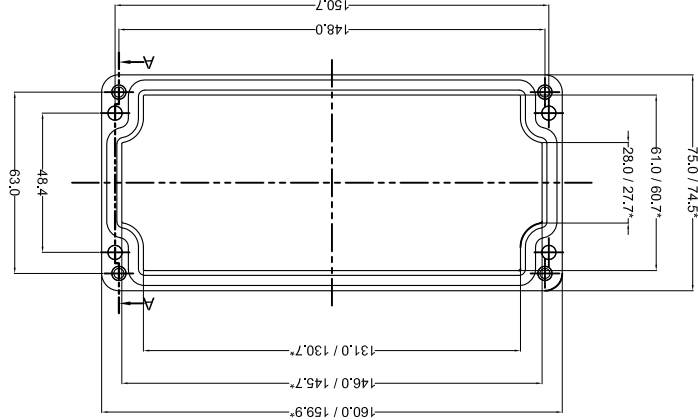

BASE

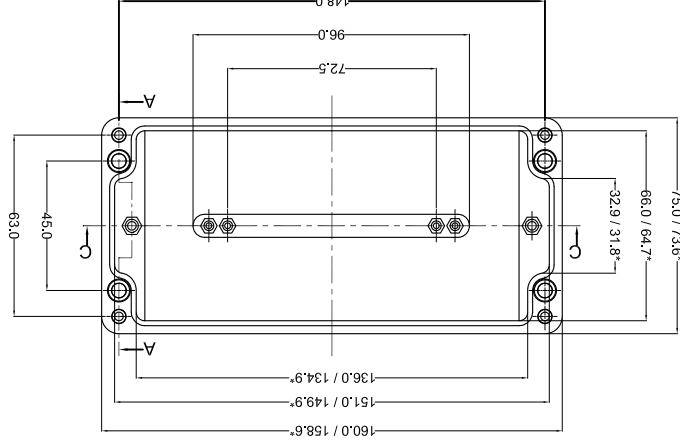

SECTION C-C

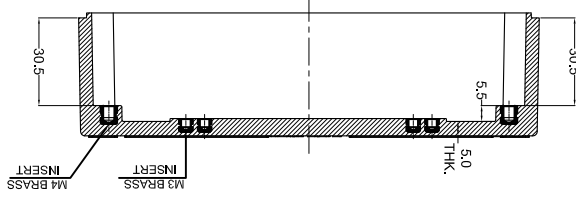

PROPERTY OF RaychemRFG (P) LTD.
 ALL RIGHTS RESERVED AND/OR PHOTOCOPYING THIS DOCUMENT
 TO A PERSON WITHOUT RaychemRFG (P) LTD. WRITTEN AUTHORIZATION IS PROHIBITED

Sr.No.	Drawing no.	RM Grade	Finish	VERSION
1	GJB-1607555-B-01	GRP-23	GREY RAL7000	01
2	GJB-1607555-B-02	GRP-30	BLACK RAL9011	02
3	GJB-1607555-B-02	GRP-30	BLACK RAL9011	02

NO. REV.NO.	DESCRIPTION	DATE	SIGN	NAME
-	-	-	-	-

QUANTITY	MATERIAL :-	GRP
-	-	-

DATE	SIGN	NAME	RRPL DESIGN	MANOJ DRAWN	PAYAN CHECKED	M.S. APPROVED
09/01/14						
09/01/14						

SCALE	PARTNO.	DRG. NO.
REV		GJB-1607555-0

MACH NAME: _____
 TITLE :- GRP JUNCTION BOX
 160 x 75 x 55
 Raychem RFG (P) Limited
 Ceat Mahal Annex,
 Dr. Amie Besant Road,
 Worli, Mumbai 400030
 Web: www.raychemrfg.com
 GRJ 05
 ALL DIMENSION ARE IN MM
 ANGLES ±1.0°
 HOLES ±0.2
 TOLERANCE ±0.2
 WEIGHT: FINISH: _____
 GRP

X-ON Electronics

Largest Supplier of Electrical and Electronic Components

Click to view similar products for [Enclosures, Boxes, & Cases](#) *category:*

Click to view products by [TE Connectivity](#) *manufacturer:*

Other Similar products are found below :

[CR-425 PAINTED](#) [585-R-WH-PK](#) [M-10-PLATED](#) [60221-01](#) [60566-01-000](#) [HPL-9VB BATT DOOR](#) [M-16-LID-PLATED](#) [M18-PLTD](#) [M-21-LID-PLATED](#) [M-21-PLATED](#) [M-23-PLATED](#) [CU-281-MB](#) [6711GSKT](#) [71884-29-028](#) [LH45-100 Black](#) [7200B](#) [72868-510-000](#) [CNS-0000 Black](#) [72883-510-000](#) [CNS-0101 Black](#) [72906-510-000](#) [CNS-0407 Black](#) [73091-510-000](#) [CNM-0000-BLACK Kit](#) [73092-510-000](#) [CNM-0101 Black](#) [73108-510-000](#) [CNL-0303 Black](#) [73395-510-039](#) [CNS-0006 Bone](#) [74257-510-000](#) [CNL-0004](#) [MDC-1183-PLAIN-ALUM](#) [MDC-1183-PTD](#) [MDC-13104-PLAIN-ALUM](#) [MDC-211 - PAINTED IVORY/BEIGE](#) [MDC-321-PTD](#) [MDC-432-PLAIN-ALUM](#) [MDC-973-PTD](#) [76](#) [77153-01-028](#) [FLX6030](#) [83535-01-508](#) [PS-11296-G](#) [PS-11298-B](#) [116-508](#) [120-407](#) [120-412](#) [120-909](#) [120-455](#) [R272-100-000](#) [120-910](#) [R501-001-010](#) [R508-080-000](#) [R508-160-000](#) [R530-120-000](#) [R530-122-000](#) [R530-200-000](#) [R531-160-000](#) [R531-200-000](#) [R582-080-100](#)