

Installation Products for Industrial Applications



Product Information

- Circuit Breakers FAZ



Powering Business Worldwide



Optimum and powerful protection for every application

When it comes to protecting and switching, industry in many countries relies on Eaton products.

Top product quality as well as tested reliability and safety guarantee a high level of protection for people, installations and systems. Official approvals in many countries prove that Eaton builds its products in line with the latest national and international regulations.

up to 25 kA	IEC/EN 60947-2
up to 15 kA	IEC/EN 60898-1
up to 14 kA	UL 489
up to 10 kA	UL 1077
10 kA	IEC/EN 60947-2
at 60 V DC 1-pole at 120 V DC 2-pole	(for FAZT only)

Content FAZ Miniature Circuit Breakers (MCBs)

SG06811



FAZ

Characteristic B	.XX
Characteristic C	.XX
Characteristic D	.XX
Characteristic K	.XX
Characteristic S	.XX
Characteristic Z	.XX

FAZ-PN

Characteristic B	.XX
Characteristic C	.XX

FAZ-...-HS

Characteristic B	.XX
------------------	-----

FAZ Specifications

Specifications	.XX
Dimensions	.XX
Tripping Characteristic	.XX
Internal Resistance	.XX
Fault Loop Impedance	.XX
Power Loss	.XX
Influence of Ambient Temperature	.XX
Maximum Let-Through Energy	.XX
Maximum Let-Through Current	.XX
Short Circuit Selectivity	.XX
Back-up Protection	.XX
Overload Selectivity	.XX
Influence of the Line Frequency	.XX
BB Busbars	.XX
Accessories	.XX

FAZ-T

Characteristic B	.XX
Characteristic C	.XX
Characteristic D	.XX

FAZ-T, FAZ-...-DC Specifications

Specifications	.XX
Dimensions	.XX
Tripping Characteristic	.XX
Power Loss	.XX
Influence of Ambient Temperature	.XX
Influence of the Line Frequency	.XX
Load rating in case of circuit breakers arranged one next to the other	.XX
Maximum Let-Through Energy	.XX
Maximum Let-Through Current	.XX

FAZ-...-DC

Characteristic C	.XX
------------------	-----

Content FAZ Miniature Circuit Breakers (MCBs)

FAZ-...-DC Specifications

SpecificationsXX
DimensionsXX
Tripping CharacteristicXX

FAZ-...-NA

Characteristic BXX
Characteristic CXX
Characteristic DXX

FAZ-...-NA-DC

Characteristic CXX
------------------------	-----

FAZ-...-RT

Characteristic BXX
Characteristic CXX
Characteristic DXX

FAZ-NA/RT Specifications

SpecificationsXX
DimensionsXX
Tripping CharacteristicXX
Internal ResistanceXX
Power LossXX
Maximum Let-Through EnergyXX
Maximum Let-Through CurrentXX
Z-SV/UL-16 BusbarsXX
AccessoriesXX

FAZ | Characteristic B

FAZ Miniature Circuit Breakers (MCBs) Characteristic B

SG06811



Rated current I_n (A)	Rated voltage (V)	Breaking capacity acc. to IEC/EN 60947-2 (kA)	Rated voltage UL1077 (V)	Breaking capacity acc. to UL1077 (kA)	Type Designation	Article No.	Units per package
----------------------------	----------------------	---	--------------------------------	--	---------------------	-------------	-------------------------

1-pole

1	240/415	15	277	10	FAZ-B1/1	278520	12/120
1,5	240/415	15	277	10	FAZ-B1,5/1	278521	12/120
1,6	240/415	15	277	10	FAZ-B1,6/1	278522	12/120
2	240/415	15	277	10	FAZ-B2/1	278523	12/120
2,5	240/415	15	277	10	FAZ-B2,5/1	278524	12/120
3	240/415	15	277	10	FAZ-B3/1	278525	12/120
3,5	240/415	15	277	10	FAZ-B3,5/1	278526	12/120
4	240/415	15	277	10	FAZ-B4/1	278527	12/120
5	240/415	15	277	10	FAZ-B5/1	278528	12/120
6	240/415	15	277	10	FAZ-B6/1	278529	12/120
8	240/415	15	277	10	FAZ-B8/1	278530	12/120
10	240/415	15	277	10	FAZ-B10/1	278531	12/120
12	240/415	15	277	10	FAZ-B12/1	278532	12/120
13	240/415	15	277	10	FAZ-B13/1	278533	12/120
15	240/415	15	277	10	FAZ-B15/1	278534	12/120
16	240/415	15	277	10	FAZ-B16/1	278535	12/120
20	240/415	15	277	10	FAZ-B20/1	278536	12/120
25	240/415	15	277	10	FAZ-B25/1	278537	12/120
32	240/415	15	277	10	FAZ-B32/1	278538	12/120
40	240/415	15	277	5	FAZ-B40/1	278539	12/120
50	240/415	15	277	5	FAZ-B50/1	278540	12/120
63	240/415	15	277	5	FAZ-B63/1	278541	12/120

SG06911



1+N-pole

1	240	15	277	10	FAZ-B1/1N	278633	1/60
1,5	240	15	277	10	FAZ-B1,5/1N	278634	1/60
1,6	240	15	277	10	FAZ-B1,6/1N	278635	1/60
2	240	15	277	10	FAZ-B2/1N	278636	1/60
2,5	240	15	277	10	FAZ-B2,5/1N	278637	1/60
3	240	15	277	10	FAZ-B3/1N	278638	1/60
3,5	240	15	277	10	FAZ-B3,5/1N	278639	1/60
4	240	15	277	10	FAZ-B4/1N	278640	1/60
5	240	15	277	10	FAZ-B5/1N	278641	1/60
6	240	15	277	10	FAZ-B6/1N	278642	1/60
8	240	15	277	10	FAZ-B8/1N	278643	1/60
10	240	15	277	10	FAZ-B10/1N	278644	1/60
12	240	15	277	10	FAZ-B12/1N	278645	1/60
13	240	15	277	10	FAZ-B13/1N	278646	1/60
15	240	15	277	10	FAZ-B15/1N	278647	1/60
16	240	15	277	10	FAZ-B16/1N	278648	1/60
20	240	15	277	10	FAZ-B20/1N	278649	1/60
25	240	15	277	10	FAZ-B25/1N	278650	1/60
32	240	15	277	10	FAZ-B32/1N	278651	1/60
40	240	15	277	5	FAZ-B40/1N	278652	1/60
50	240	15	277	5	FAZ-B50/1N	278653	1/60
63	240	15	277	5	FAZ-B63/1N	278654	1/60

FAZ | Characteristic B

SG07011



Rated current I_n (A)	Rated voltage (V)	Breaking capacity acc. to IEC/EN 60947-2 (kA)	Rated voltage UL1077 (V)	Breaking capacity acc. to UL1077 (kA)	Type Designation	Article No.	Units per package
2-pole							
1	415	15	480Y/277	10	FAZ-B1/2	278719	1/60
1,5	415	15	480Y/277	10	FAZ-B1,5/2	278720	1/60
1,6	415	15	480Y/277	10	FAZ-B1,6/2	278721	1/60
2	415	15	480Y/277	10	FAZ-B2/2	278722	1/60
2,5	415	15	480Y/277	10	FAZ-B2,5/2	278723	1/60
3	415	15	480Y/277	10	FAZ-B3/2	278724	1/60
3,5	415	15	480Y/277	10	FAZ-B3,5/2	278725	1/60
4	415	15	480Y/277	10	FAZ-B4/2	278726	1/60
5	415	15	480Y/277	10	FAZ-B5/2	278727	1/60
6	415	15	480Y/277	10	FAZ-B6/2	278728	1/60
8	415	15	480Y/277	10	FAZ-B8/2	278729	1/60
10	415	15	480Y/277	10	FAZ-B10/2	278730	1/60
12	415	15	480Y/277	10	FAZ-B12/2	278731	1/60
13	415	15	480Y/277	10	FAZ-B13/2	278732	1/60
15	415	15	480Y/277	10	FAZ-B15/2	278733	1/60
16	415	15	480Y/277	10	FAZ-B16/2	278734	1/60
20	415	15	480Y/277	10	FAZ-B20/2	278735	1/60
25	415	15	480Y/277	10	FAZ-B25/2	278736	1/60
32	415	15	480Y/277	10	FAZ-B32/2	278737	1/60
40	415	15	480Y/277	5	FAZ-B40/2	278738	1/60
50	415	15	480Y/277	5	FAZ-B50/2	278739	1/60
63	415	15	480Y/277	5	FAZ-B63/2	278740	1/60

SG07111



Rated current I_n (A)	Rated voltage (V)	Breaking capacity acc. to IEC/EN 60947-2 (kA)	Rated voltage UL1077 (V)	Breaking capacity acc. to UL1077 (kA)	Type Designation	Article No.	Units per package
3-pole							
1	415	15	480Y/277	10	FAZ-B1/3	278832	1/40
1,5	415	15	480Y/277	10	FAZ-B1,5/3	278833	1/40
1,6	415	15	480Y/277	10	FAZ-B1,6/3	278834	1/40
2	415	15	480Y/277	10	FAZ-B2/3	278835	1/40
2,5	415	15	480Y/277	10	FAZ-B2,5/3	278836	1/40
3	415	15	480Y/277	10	FAZ-B3/3	278837	1/40
3,5	415	15	480Y/277	10	FAZ-B3,5/3	278838	1/40
4	415	15	480Y/277	10	FAZ-B4/3	278839	1/40
5	415	15	480Y/277	10	FAZ-B5/3	278840	1/40
6	415	15	480Y/277	10	FAZ-B6/3	278841	1/40
8	415	15	480Y/277	10	FAZ-B8/3	278842	1/40
10	415	15	480Y/277	10	FAZ-B10/3	278843	1/40
12	415	15	480Y/277	10	FAZ-B12/3	278844	1/40
13	415	15	480Y/277	10	FAZ-B13/3	278845	1/40
15	415	15	480Y/277	10	FAZ-B15/3	278846	1/40
16	415	15	480Y/277	10	FAZ-B16/3	278847	1/40
20	415	15	480Y/277	10	FAZ-B20/3	278848	1/40
25	415	15	480Y/277	10	FAZ-B25/3	278849	1/40
32	415	15	480Y/277	10	FAZ-B32/3	278850	1/40
40	415	15	480Y/277	5	FAZ-B40/3	278851	1/40
50	415	15	480Y/277	5	FAZ-B50/3	278852	1/40
63	415	15	480Y/277	5	FAZ-B63/3	278853	1/40

FAZ | Characteristic B

SG07311



Rated current I_n (A)	Rated voltage (V)	Breaking capacity acc. to IEC/EN 60947-2 (kA)	Rated voltage UL1077 (V)	Breaking capacity acc. to UL1077 (kA)	Type Designation	Article No.	Units per package
----------------------------	----------------------	---	--------------------------------	--	---------------------	-------------	-------------------------

3+N-pole

1	415	15	480Y/277	10	FAZ-B1/3N	278934	1/30
1,5	415	15	480Y/277	10	FAZ-B1,5/3N	278935	1/30
1,6	415	15	480Y/277	10	FAZ-B1,6/3N	278936	1/30
2	415	15	480Y/277	10	FAZ-B2/3N	278937	1/30
2,5	415	15	480Y/277	10	FAZ-B2,5/3N	278938	1/30
3	415	15	480Y/277	10	FAZ-B3/3N	278939	1/30
3,5	415	15	480Y/277	10	FAZ-B3,5/3N	278940	1/30
4	415	15	480Y/277	10	FAZ-B4/3N	278941	1/30
5	415	15	480Y/277	10	FAZ-B5/3N	278942	1/30
6	415	15	480Y/277	10	FAZ-B6/3N	278943	1/30
8	415	15	480Y/277	10	FAZ-B8/3N	278944	1/30
10	415	15	480Y/277	10	FAZ-B10/3N	278945	1/30
12	415	15	480Y/277	10	FAZ-B12/3N	278946	1/30
13	415	15	480Y/277	10	FAZ-B13/3N	278947	1/30
15	415	15	480Y/277	10	FAZ-B15/3N	278948	1/30
16	415	15	480Y/277	10	FAZ-B16/3N	278949	1/30
20	415	15	480Y/277	10	FAZ-B20/3N	278950	1/30
25	415	15	480Y/277	10	FAZ-B25/3N	278951	1/30
32	415	15	480Y/277	10	FAZ-B32/3N	278952	1/30
40	415	15	480Y/277	5	FAZ-B40/3N	278953	1/30
50	415	15	480Y/277	5	FAZ-B50/3N	278954	1/30
63	415	15	480Y/277	5	FAZ-B63/3N	278955	1/30

SG07211



4-pole

1	415	15	480Y/277	10	FAZ-B1/4	279020	1/30
1,5	415	15	480Y/277	10	FAZ-B1,5/4	279021	1/30
1,6	415	15	480Y/277	10	FAZ-B1,6/4	279022	1/30
2	415	15	480Y/277	10	FAZ-B2/4	279023	1/30
2,5	415	15	480Y/277	10	FAZ-B2,5/4	279024	1/30
3	415	15	480Y/277	10	FAZ-B3/4	279025	1/30
3,5	415	15	480Y/277	10	FAZ-B3,5/4	279026	1/30
4	415	15	480Y/277	10	FAZ-B4/4	279027	1/30
5	415	15	480Y/277	10	FAZ-B5/4	279028	1/30
6	415	15	480Y/277	10	FAZ-B6/4	279029	1/30
8	415	15	480Y/277	10	FAZ-B8/4	279030	1/30
10	415	15	480Y/277	10	FAZ-B10/4	279031	1/30
12	415	15	480Y/277	10	FAZ-B12/4	279032	1/30
13	415	15	480Y/277	10	FAZ-B13/4	279033	1/30
15	415	15	480Y/277	10	FAZ-B15/4	279034	1/30
16	415	15	480Y/277	10	FAZ-B16/4	279035	1/30
20	415	15	480Y/277	10	FAZ-B20/4	279036	1/30
25	415	15	480Y/277	10	FAZ-B25/4	279037	1/30
32	415	15	480Y/277	10	FAZ-B32/4	279038	1/30
40	415	15	480Y/277	5	FAZ-B40/4	279039	1/30
50	415	15	480Y/277	5	FAZ-B50/4	279040	1/30
63	415	15	480Y/277	5	FAZ-B63/4	279041	1/30

FAZ | Characteristic C

FAZ Miniature Circuit Breakers (MCBs) Characteristic C

SG06811



Rated current I_n (A)	Rated voltage (V)	Breaking capacity acc. to IEC/EN 60947-2 (kA)	Rated voltage UL1077 (V)	Breaking capacity acc. to UL1077 (kA)	Type Designation	Article No.	Units per package
----------------------------	----------------------	---	--------------------------------	--	---------------------	-------------	-------------------------

1-pole

0,16	240/415	15	277	5	FAZ-C0,16/1	278542	12/120
0,25	240/415	15	277	5	FAZ-C0,25/1	278543	12/120
0,5	240/415	15	277	10	FAZ-C0,5/1	278544	12/120
0,75	240/415	15	277	10	FAZ-C0,75/1	278545	12/120
1	240/415	15	277	10	FAZ-C1/1	278546	12/120
1,5	240/415	15	277	10	FAZ-C1,5/1	278547	12/120
1,6	240/415	15	277	10	FAZ-C1,6/1	278548	12/120
2	240/415	15	277	10	FAZ-C2/1	278549	12/120
2,5	240/415	15	277	10	FAZ-C2,5/1	278550	12/120
3	240/415	15	277	10	FAZ-C3/1	278551	12/120
3,5	240/415	15	277	10	FAZ-C3,5/1	278552	12/120
4	240/415	15	277	10	FAZ-C4/1	278553	12/120
5	240/415	15	277	10	FAZ-C5/1	278554	12/120
6	240/415	15	277	10	FAZ-C6/1	278555	12/120
8	240/415	15	277	10	FAZ-C8/1	278556	12/120
10	240/415	15	277	10	FAZ-C10/1	278557	12/120
12	240/415	15	277	10	FAZ-C12/1	278558	12/120
13	240/415	15	277	10	FAZ-C13/1	278559	12/120
15	240/415	15	277	10	FAZ-C15/1	278560	12/120
16	240/415	15	277	10	FAZ-C16/1	278561	12/120
20	240/415	15	277	10	FAZ-C20/1	278562	12/120
25	240/415	15	277	10	FAZ-C25/1	278563	12/120
32	240/415	15	277	10	FAZ-C32/1	278564	12/120
40	240/415	15	277	5	FAZ-C40/1	278565	12/120
50	240/415	15	277	5	FAZ-C50/1	278566	12/120
63	240/415	15	277	5	FAZ-C63/1	278567	12/120

SG06911



1+N-pole

0,16	240	15	277	5	FAZ-C0,16/1N	278655	1/60
0,25	240	15	277	5	FAZ-C0,25/1N	278656	1/60
0,5	240	15	277	10	FAZ-C0,5/1N	278657	1/60
0,75	240	15	277	10	FAZ-C0,75/1N	278658	1/60
1	240	15	277	10	FAZ-C1/1N	278659	1/60
1,5	240	15	277	10	FAZ-C1,5/1N	278660	1/60
1,6	240	15	277	10	FAZ-C1,6/1N	278661	1/60
2	240	15	277	10	FAZ-C2/1N	278662	1/60
2,5	240	15	277	10	FAZ-C2,5/1N	278663	1/60
3	240	15	277	10	FAZ-C3/1N	278664	1/60
3,5	240	15	277	10	FAZ-C3,5/1N	278665	1/60
4	240	15	277	10	FAZ-C4/1N	278666	1/60
5	240	15	277	10	FAZ-C5/1N	278667	1/60
6	240	15	277	10	FAZ-C6/1N	278668	1/60
8	240	15	277	10	FAZ-C8/1N	278669	1/60
10	240	15	277	10	FAZ-C10/1N	278670	1/60
12	240	15	277	10	FAZ-C12/1N	278671	1/60
13	240	15	277	10	FAZ-C13/1N	278672	1/60
15	240	15	277	10	FAZ-C15/1N	278673	1/60
16	240	15	277	10	FAZ-C16/1N	278674	1/60
20	240	15	277	10	FAZ-C20/1N	278675	1/60
25	240	15	277	10	FAZ-C25/1N	278676	1/60
32	240	15	277	10	FAZ-C32/1N	278677	1/60
40	240	15	277	5	FAZ-C40/1N	278678	1/60
50	240	15	277	5	FAZ-C50/1N	278679	1/60
63	240	15	277	5	FAZ-C63/1N	278680	1/60

FAZ | Characteristic C

SG07011



Rated current I_n (A)	Rated voltage (V)	Breaking capacity acc. to IEC/EN 60947-2 (kA)	Rated voltage UL1077 (V)	Breaking capacity acc. to UL1077 (kA)	Type Designation	Article No.	Units per package
----------------------------	----------------------	---	--------------------------------	--	---------------------	-------------	-------------------------

2-pole

0,16	415	15	480Y/277	5	FAZ-C0,16/2	278741	1/60
0,25	415	15	480Y/277	5	FAZ-C0,25/2	278742	1/60
0,5	415	15	480Y/277	10	FAZ-C0,5/2	278743	1/60
0,75	415	15	480Y/277	10	FAZ-C0,75/2	278744	1/60
1	415	15	480Y/277	10	FAZ-C1/2	278745	1/60
1,5	415	15	480Y/277	10	FAZ-C1,5/2	278746	1/60
1,6	415	15	480Y/277	10	FAZ-C1,6/2	278747	1/60
2	415	15	480Y/277	10	FAZ-C2/2	278748	1/60
2,5	415	15	480Y/277	10	FAZ-C2,5/2	278749	1/60
3	415	15	480Y/277	10	FAZ-C3/2	278750	1/60
3,5	415	15	480Y/277	10	FAZ-C3,5/2	278751	1/60
4	415	15	480Y/277	10	FAZ-C4/2	278752	1/60
5	415	15	480Y/277	10	FAZ-C5/2	278753	1/60
6	415	15	480Y/277	10	FAZ-C6/2	278754	1/60
8	415	15	480Y/277	10	FAZ-C8/2	278755	1/60
10	415	15	480Y/277	10	FAZ-C10/2	278756	1/60
12	415	15	480Y/277	10	FAZ-C12/2	278757	1/60
13	415	15	480Y/277	10	FAZ-C13/2	278758	1/60
15	415	15	480Y/277	10	FAZ-C15/2	278759	1/60
16	415	15	480Y/277	10	FAZ-C16/2	278760	1/60
20	415	15	480Y/277	10	FAZ-C20/2	278761	1/60
25	415	15	480Y/277	10	FAZ-C25/2	278762	1/60
32	415	15	480Y/277	10	FAZ-C32/2	278763	1/60
40	415	15	480Y/277	5	FAZ-C40/2	278764	1/60
50	415	15	480Y/277	5	FAZ-C50/2	278765	1/60
63	415	15	480Y/277	5	FAZ-C63/2	278766	1/60

SG07111



3-pole

0,16	415	15	480Y/277	5	FAZ-C0,16/3	278854	1/40
0,25	415	15	480Y/277	5	FAZ-C0,25/3	278855	1/40
0,5	415	15	480Y/277	10	FAZ-C0,5/3	278856	1/40
0,75	415	15	480Y/277	10	FAZ-C0,75/3	278857	1/40
1	415	15	480Y/277	10	FAZ-C1/3	278858	1/40
1,5	415	15	480Y/277	10	FAZ-C1,5/3	278859	1/40
1,6	415	15	480Y/277	10	FAZ-C1,6/3	278860	1/40
2	415	15	480Y/277	10	FAZ-C2/3	278861	1/40
2,5	415	15	480Y/277	10	FAZ-C2,5/3	278862	1/40
3	415	15	480Y/277	10	FAZ-C3/3	278863	1/40
3,5	415	15	480Y/277	10	FAZ-C3,5/3	278864	1/40
4	415	15	480Y/277	10	FAZ-C4/3	278865	1/40
5	415	15	480Y/277	10	FAZ-C5/3	278866	1/40
6	415	15	480Y/277	10	FAZ-C6/3	278867	1/40
8	415	15	480Y/277	10	FAZ-C8/3	278868	1/40
10	415	15	480Y/277	10	FAZ-C10/3	278869	1/40
12	415	15	480Y/277	10	FAZ-C12/3	278870	1/40
13	415	15	480Y/277	10	FAZ-C13/3	278871	1/40
15	415	15	480Y/277	10	FAZ-C15/3	278872	1/40
16	415	15	480Y/277	10	FAZ-C16/3	278873	1/40
20	415	15	480Y/277	10	FAZ-C20/3	278874	1/40
25	415	15	480Y/277	10	FAZ-C25/3	278875	1/40
32	415	15	480Y/277	10	FAZ-C32/3	278876	1/40
40	415	15	480Y/277	5	FAZ-C40/3	278877	1/40
50	415	15	480Y/277	5	FAZ-C50/3	278878	1/40
63	415	15	480Y/277	5	FAZ-C63/3	278879	1/40

FAZ | Characteristic C

SG07311



Rated current I_n (A)	Rated voltage (V)	Breaking capacity acc. to IEC/EN 60947-2 (kA)	Rated voltage UL1077 (V)	Breaking capacity acc. to UL1077 (kA)	Type Designation	Article No.	Units per package
----------------------------	----------------------	---	--------------------------------	--	---------------------	-------------	-------------------------

3+N-pole

0,16	415	15	480Y/277	5	FAZ-C0,16/3N	278956	1/30
0,25	415	15	480Y/277	5	FAZ-C0,25/3N	278957	1/30
0,5	415	15	480Y/277	10	FAZ-C0,5/3N	278958	1/30
0,75	415	15	480Y/277	10	FAZ-C0,75/3N	278959	1/30
1	415	15	480Y/277	10	FAZ-C1/3N	278960	1/30
1,5	415	15	480Y/277	10	FAZ-C1,5/3N	278961	1/30
1,6	415	15	480Y/277	10	FAZ-C1,6/3N	278962	1/30
2	415	15	480Y/277	10	FAZ-C2/3N	278963	1/30
2,5	415	15	480Y/277	10	FAZ-C2,5/3N	278964	1/30
3	415	15	480Y/277	10	FAZ-C3/3N	278965	1/30
3,5	415	15	480Y/277	10	FAZ-C3,5/3N	278966	1/30
4	415	15	480Y/277	10	FAZ-C4/3N	278967	1/30
5	415	15	480Y/277	10	FAZ-C5/3N	278968	1/30
6	415	15	480Y/277	10	FAZ-C6/3N	278969	1/30
8	415	15	480Y/277	10	FAZ-C8/3N	278970	1/30
10	415	15	480Y/277	10	FAZ-C10/3N	278971	1/30
12	415	15	480Y/277	10	FAZ-C12/3N	278972	1/30
13	415	15	480Y/277	10	FAZ-C13/3N	278973	1/30
15	415	15	480Y/277	10	FAZ-C15/3N	278974	1/30
16	415	15	480Y/277	10	FAZ-C16/3N	278975	1/30
20	415	15	480Y/277	10	FAZ-C20/3N	278976	1/30
25	415	15	480Y/277	10	FAZ-C25/3N	278977	1/30
32	415	15	480Y/277	10	FAZ-C32/3N	278978	1/30
40	415	15	480Y/277	5	FAZ-C40/3N	278979	1/30
50	415	15	480Y/277	5	FAZ-C50/3N	278980	1/30
63	415	15	480Y/277	5	FAZ-C63/3N	278981	1/30

SG07211



4-pole

0,16	415	15	480Y/277	5	FAZ-C0,16/4	279042	1/30
0,25	415	15	480Y/277	5	FAZ-C0,25/4	279043	1/30
0,5	415	15	480Y/277	10	FAZ-C0,5/4	279044	1/30
0,75	415	15	480Y/277	10	FAZ-C0,75/4	279045	1/30
1	415	15	480Y/277	10	FAZ-C1/4	279046	1/30
1,5	415	15	480Y/277	10	FAZ-C1,5/4	279047	1/30
1,6	415	15	480Y/277	10	FAZ-C1,6/4	279048	1/30
2	415	15	480Y/277	10	FAZ-C2/4	279049	1/30
2,5	415	15	480Y/277	10	FAZ-C2,5/4	279050	1/30
3	415	15	480Y/277	10	FAZ-C3/4	279051	1/30
3,5	415	15	480Y/277	10	FAZ-C3,5/4	279052	1/30
4	415	15	480Y/277	10	FAZ-C4/4	279053	1/30
5	415	15	480Y/277	10	FAZ-C5/4	279054	1/30
6	415	15	480Y/277	10	FAZ-C6/4	279055	1/30
8	415	15	480Y/277	10	FAZ-C8/4	279056	1/30
10	415	15	480Y/277	10	FAZ-C10/4	279057	1/30
12	415	15	480Y/277	10	FAZ-C12/4	279058	1/30
13	415	15	480Y/277	10	FAZ-C13/4	279059	1/30
15	415	15	480Y/277	10	FAZ-C15/4	279060	1/30
16	415	15	480Y/277	10	FAZ-C16/4	279061	1/30
20	415	15	480Y/277	10	FAZ-C20/4	279062	1/30
25	415	15	480Y/277	10	FAZ-C25/4	279063	1/30
32	415	15	480Y/277	10	FAZ-C32/4	279064	1/30
40	415	15	480Y/277	5	FAZ-C40/4	279065	1/30
50	415	15	480Y/277	5	FAZ-C50/4	279066	1/30
63	415	15	480Y/277	5	FAZ-C63/4	279067	1/30

FAZ | Characteristic D

FAZ Miniature Circuit Breakers (MCBs)

Characteristic D

SG06811



Rated current I_n (A)	Rated voltage (V)	Breaking capacity acc. to IEC/EN 60947-2 (kA)	Rated voltage UL1077 (V)	Breaking capacity acc. to UL1077 (kA)	Type Designation	Article No.	Units per package
----------------------------	----------------------	---	--------------------------------	--	---------------------	-------------	-------------------------

1-pole

0,5	240/415	15	277	5	FAZ-D0,5/1	278568	12/120
1	240/415	15	277	5	FAZ-D1/1	278569	12/120
1,5	240/415	15	277	5	FAZ-D1,5/1	278570	12/120
1,6	240/415	15	277	5	FAZ-D1,6/1	278571	12/120
2	240/415	15	277	5	FAZ-D2/1	278572	12/120
2,5	240/415	15	277	5	FAZ-D2,5/1	278573	12/120
3	240/415	15	277	5	FAZ-D3/1	278574	12/120
3,5	240/415	15	277	5	FAZ-D3,5/1	278575	12/120
4	240/415	15	277	5	FAZ-D4/1	278576	12/120
5	240/415	15	277	5	FAZ-D5/1	278577	12/120
6	240/415	15	277	5	FAZ-D6/1	278578	12/120
8	240/415	15	277	5	FAZ-D8/1	278579	12/120
10	240/415	15	277	5	FAZ-D10/1	278580	12/120
12	240/415	15	277	5	FAZ-D12/1	278581	12/120
13	240/415	15	277	5	FAZ-D13/1	278582	12/120
15	240/415	15	277	5	FAZ-D15/1	278583	12/120
16	240/415	15	277	5	FAZ-D16/1	278584	12/120
20	240/415	15	277	5	FAZ-D20/1	278585	12/120
25	240/415	15	277	5	FAZ-D25/1	278586	12/120
32	240/415	15	277	5	FAZ-D32/1	278587	12/120
40	240/415	15	277	5	FAZ-D40/1	278588	12/120
50	240/415	10	-	-	FAZ-D50/1	115370	12/120
63	240/415	10	-	-	FAZ-D63/1	115371	12/120

SG06811



1+N-pole

0,5	240	15	277	5	FAZ-D0,5/1N	278681	1/60
1	240	15	277	5	FAZ-D1/1N	278682	1/60
1,5	240	15	277	5	FAZ-D1,5/1N	278683	1/60
1,6	240	15	277	5	FAZ-D1,6/1N	278684	1/60
2	240	15	277	5	FAZ-D2/1N	278685	1/60
2,5	240	15	277	5	FAZ-D2,5/1N	278686	1/60
3	240	15	277	5	FAZ-D3/1N	278687	1/60
3,5	240	15	277	5	FAZ-D3,5/1N	278688	1/60
4	240	15	277	5	FAZ-D4/1N	278689	1/60
5	240	15	277	5	FAZ-D5/1N	278690	1/60
6	240	15	277	5	FAZ-D6/1N	278691	1/60
8	240	15	277	5	FAZ-D8/1N	278692	1/60
10	240	15	277	5	FAZ-D10/1N	278693	1/60
12	240	15	277	5	FAZ-D12/1N	278694	1/60
13	240	15	277	5	FAZ-D13/1N	278695	1/60
15	240	15	277	5	FAZ-D15/1N	278696	1/60
16	240	15	277	5	FAZ-D16/1N	278697	1/60
20	240	15	277	5	FAZ-D20/1N	278698	1/60
25	240	15	277	5	FAZ-D25/1N	278699	1/60
32	240	15	277	5	FAZ-D32/1N	278700	1/60
40	240	15	277	5	FAZ-D40/1N	278701	1/60
50	240	10	-	-	FAZ-D50/1N	115378	1/60
63	240	10	-	-	FAZ-D63/1N	115379	1/60

FAZ | Characteristic D

SG07011



Rated current I_n (A)	Rated voltage (V)	Breaking capacity acc. to IEC/EN 60947-2 (kA)	Rated voltage UL1077 (V)	Breaking capacity acc. to UL1077 (kA)	Type Designation	Article No.	Units per package
----------------------------	----------------------	---	--------------------------------	--	---------------------	-------------	-------------------------

2-pole

0,5	415	15	480Y/277	5	FAZ-D0,5/2	278767	1/60
1	415	15	480Y/277	5	FAZ-D1/2	278768	1/60
1,5	415	15	480Y/277	5	FAZ-D1,5/2	278769	1/60
1,6	415	15	480Y/277	5	FAZ-D1,6/2	278770	1/60
2	415	15	480Y/277	5	FAZ-D2/2	278771	1/60
2,5	415	15	480Y/277	5	FAZ-D2,5/2	278772	1/60
3	415	15	480Y/277	5	FAZ-D3/2	278773	1/60
3,5	415	15	480Y/277	5	FAZ-D3,5/2	278774	1/60
4	415	15	480Y/277	5	FAZ-D4/2	278775	1/60
5	415	15	480Y/277	5	FAZ-D5/2	278776	1/60
6	415	15	480Y/277	5	FAZ-D6/2	278777	1/60
8	415	15	480Y/277	5	FAZ-D8/2	278778	1/60
10	415	15	480Y/277	5	FAZ-D10/2	278779	1/60
12	415	15	480Y/277	5	FAZ-D12/2	278780	1/60
13	415	15	480Y/277	5	FAZ-D13/2	278781	1/60
15	415	15	480Y/277	5	FAZ-D15/2	278782	1/60
16	415	15	480Y/277	5	FAZ-D16/2	278783	1/60
20	415	15	480Y/277	5	FAZ-D20/2	278784	1/60
25	415	15	480Y/277	5	FAZ-D25/2	278785	1/60
32	415	15	480Y/277	5	FAZ-D32/2	278786	1/60
40	415	15	480Y/277	5	FAZ-D40/2	278787	1/60
50	415	10	-	-	FAZ-D50/2	115372	1/60
63	415	10	-	-	FAZ-D63/2	115373	1/60

SG07111



3-pole

0,5	415	15	480Y/277	5	FAZ-D0,5/3	278880	1/40
1	415	15	480Y/277	5	FAZ-D1/3	278881	1/40
1,5	415	15	480Y/277	5	FAZ-D1,5/3	278882	1/40
1,6	415	15	480Y/277	5	FAZ-D1,6/3	278883	1/40
2	415	15	480Y/277	5	FAZ-D2/3	278884	1/40
2,5	415	15	480Y/277	5	FAZ-D2,5/3	278885	1/40
3	415	15	480Y/277	5	FAZ-D3/3	278886	1/40
3,5	415	15	480Y/277	5	FAZ-D3,5/3	278887	1/40
4	415	15	480Y/277	5	FAZ-D4/3	278888	1/40
5	415	15	480Y/277	5	FAZ-D5/3	278889	1/40
6	415	15	480Y/277	5	FAZ-D6/3	278890	1/40
8	415	15	480Y/277	5	FAZ-D8/3	278891	1/40
10	415	15	480Y/277	5	FAZ-D10/3	278892	1/40
12	415	15	480Y/277	5	FAZ-D12/3	278893	1/40
13	415	15	480Y/277	5	FAZ-D13/3	278894	1/40
15	415	15	480Y/277	5	FAZ-D15/3	278895	1/40
16	415	15	480Y/277	5	FAZ-D16/3	278896	1/40
20	415	15	480Y/277	5	FAZ-D20/3	278897	1/40
25	415	15	480Y/277	5	FAZ-D25/3	278898	1/40
32	415	15	480Y/277	5	FAZ-D32/3	278899	1/40
40	415	15	480Y/277	5	FAZ-D40/3	278900	1/40
50	415	10	-	-	FAZ-D50/3	115374	1/40
63	415	10	-	-	FAZ-D63/3	115375	1/40

FAZ | Characteristic D

SG07311



Rated current I_n (A)	Rated voltage (V)	Breaking capacity acc. to IEC/EN 60947-2 (kA)	Rated voltage UL1077 (V)	Breaking capacity acc. to UL1077 (kA)	Type Designation	Article No.	Units per package
----------------------------	----------------------	---	--------------------------------	--	---------------------	-------------	-------------------------

3+N-pole

0,5	415	15	480Y/277	5	FAZ-D,5/3N	278982	1/30
1	415	15	480Y/277	5	FAZ-D1/3N	278983	1/30
1,5	415	15	480Y/277	5	FAZ-D1,5/3N	278984	1/30
1,6	415	15	480Y/277	5	FAZ-D1,6/3N	278985	1/30
2	415	15	480Y/277	5	FAZ-D2/3N	278986	1/30
2,5	415	15	480Y/277	5	FAZ-D2,5/3N	278987	1/30
3	415	15	480Y/277	5	FAZ-D3/3N	278988	1/30
3,5	415	15	480Y/277	5	FAZ-D3,5/3N	278989	1/30
4	415	15	480Y/277	5	FAZ-D4/3N	278990	1/30
5	415	15	480Y/277	5	FAZ-D5/3N	278991	1/30
6	415	15	480Y/277	5	FAZ-D6/3N	278992	1/30
8	415	15	480Y/277	5	FAZ-D8/3N	278993	1/30
10	415	15	480Y/277	5	FAZ-D10/3N	278994	1/30
12	415	15	480Y/277	5	FAZ-D12/3N	278995	1/30
13	415	15	480Y/277	5	FAZ-D13/3N	278996	1/30
15	415	15	480Y/277	5	FAZ-D15/3N	278997	1/30
16	415	15	480Y/277	5	FAZ-D16/3N	278998	1/30
20	415	15	480Y/277	5	FAZ-D20/3N	278999	1/30
25	415	15	480Y/277	5	FAZ-D25/3N	279000	1/30
32	415	15	480Y/277	5	FAZ-D32/3N	279001	1/30
40	415	15	480Y/277	5	FAZ-D40/3N	279002	1/30
50	415	10	-	-	FAZ-D50/3N	115380	1/30
63	415	10	-	-	FAZ-D63/3N	115381	1/30

SG07211



4-pole

0,5	415	15	480Y/277	5	FAZ-D0,5/4	279068	1/30
1	415	15	480Y/277	5	FAZ-D1/4	279069	1/30
1,5	415	15	480Y/277	5	FAZ-D1,5/4	279070	1/30
1,6	415	15	480Y/277	5	FAZ-D1,6/4	279071	1/30
2	415	15	480Y/277	5	FAZ-D2/4	279072	1/30
2,5	415	15	480Y/277	5	FAZ-D2,5/4	279073	1/30
3	415	15	480Y/277	5	FAZ-D3/4	279074	1/30
3,5	415	15	480Y/277	5	FAZ-D3,5/4	279075	1/30
4	415	15	480Y/277	5	FAZ-D4/4	279076	1/30
5	415	15	480Y/277	5	FAZ-D5/4	279077	1/30
6	415	15	480Y/277	5	FAZ-D6/4	279078	1/30
8	415	15	480Y/277	5	FAZ-D8/4	279079	1/30
10	415	15	480Y/277	5	FAZ-D10/4	279080	1/30
12	415	15	480Y/277	5	FAZ-D12/4	279081	1/30
13	415	15	480Y/277	5	FAZ-D13/4	279082	1/30
15	415	15	480Y/277	5	FAZ-D15/4	279083	1/30
16	415	15	480Y/277	5	FAZ-D16/4	279084	1/30
20	415	15	480Y/277	5	FAZ-D20/4	279085	1/30
25	415	15	480Y/277	5	FAZ-D25/4	279086	1/30
32	415	15	480Y/277	5	FAZ-D32/4	279087	1/30
40	415	15	480Y/277	5	FAZ-D40/4	279088	1/30
50	415	10	-	-	FAZ-D50/4	115376	1/30
63	415	10	-	-	FAZ-D63/4	115377	1/30

FAZ | Characteristic K

FAZ Miniature Circuit Breakers (MCBs) Characteristic K

SG06811



Rated current I_n (A)	Rated voltage (V)	Breaking capacity acc. to IEC/EN 60947-2 (kA)	Rated voltage UL1077 (V)	Breaking capacity acc. to UL1077 (kA)	Type Designation	Article No.	Units per package
----------------------------	----------------------	---	--------------------------------	--	---------------------	-------------	-------------------------

1-pole

0,5	240/415	15	277	5	FAZ-K0,5/1	278589	12/120
1	240/415	15	277	5	FAZ-K1/1	278590	12/120
1,6	240/415	15	277	5	FAZ-K1,6/1	278591	12/120
2	240/415	15	277	5	FAZ-K2/1	278592	12/120
3	240/415	15	277	5	FAZ-K3/1	278593	12/120
4	240/415	15	277	5	FAZ-K4/1	278594	12/120
6	240/415	15	277	5	FAZ-K6/1	278595	12/120
8	240/415	15	277	5	FAZ-K8/1	278596	12/120
10	240/415	15	277	5	FAZ-K10/1	278597	12/120
13	240/415	15	277	5	FAZ-K13/1	278598	12/120
16	240/415	15	277	5	FAZ-K16/1	278599	12/120
20	240/415	15	277	5	FAZ-K20/1	278600	12/120
25	240/415	15	277	5	FAZ-K25/1	278601	12/120
32	240/415	15	277	5	FAZ-K32/1	278602	12/120
40	240/415	15	277	5	FAZ-K40/1	278603	12/120
50	240/415	15	277	5	FAZ-K50/1	278604	12/120
63	240/415	15	277	5	FAZ-K63/1	278605	12/120

SG06811



1+N-pole

0,5	240	15	277	5	FAZ-K0,5/1N	278702	1/60
1	240	15	277	5	FAZ-K1/1N	278703	1/60
1,6	240	15	277	5	FAZ-K1,6/1N	278704	1/60
2	240	15	277	5	FAZ-K2/1N	278705	1/60
3	240	15	277	5	FAZ-K3/1N	278706	1/60
4	240	15	277	5	FAZ-K4/1N	278707	1/60
6	240	15	277	5	FAZ-K6/1N	278708	1/60
8	240	15	277	5	FAZ-K8/1N	278709	1/60
10	240	15	277	5	FAZ-K10/1N	278710	1/60
13	240	15	277	5	FAZ-K13/1N	278711	1/60
16	240	15	277	5	FAZ-K16/1N	278712	1/60
20	240	15	277	5	FAZ-K20/1N	278713	1/60
25	240	15	277	5	FAZ-K25/1N	278714	1/60
32	240	15	277	5	FAZ-K32/1N	278715	1/60
40	240	15	277	5	FAZ-K40/1N	278716	1/60
50	240	15	277	5	FAZ-K50/1N	278717	1/60
63	240	15	277	5	FAZ-K63/1N	278718	1/60

FAZ | Characteristic K

SG07011



Rated current I_n (A)	Rated voltage (V)	Breaking capacity acc. to IEC/EN 60947-2 (kA)	Rated voltage UL1077 (V)	Breaking capacity acc. to UL1077 (kA)	Type Designation	Article No.	Units per package
----------------------------	----------------------	---	--------------------------------	--	---------------------	-------------	-------------------------

2-pole

0,5	415	15	480Y/277	5	FAZ-K0,5/2	278788	1/60
1	415	15	480Y/277	5	FAZ-K1/2	278789	1/60
1,6	415	15	480Y/277	5	FAZ-K1,6/2	278790	1/60
2	415	15	480Y/277	5	FAZ-K2/2	278791	1/60
3	415	15	480Y/277	5	FAZ-K3/2	278792	1/60
4	415	15	480Y/277	5	FAZ-K4/2	278793	1/60
6	415	15	480Y/277	5	FAZ-K6/2	278794	1/60
8	415	15	480Y/277	5	FAZ-K8/2	278795	1/60
10	415	15	480Y/277	5	FAZ-K10/2	278796	1/60
13	415	15	480Y/277	5	FAZ-K13/2	278797	1/60
16	415	15	480Y/277	5	FAZ-K16/2	278798	1/60
20	415	15	480Y/277	5	FAZ-K20/2	278799	1/60
25	415	15	480Y/277	5	FAZ-K25/2	278800	1/60
32	415	15	480Y/277	5	FAZ-K32/2	278801	1/60
40	415	15	480Y/277	5	FAZ-K40/2	278802	1/60
50	415	15	480Y/277	5	FAZ-K50/2	278803	1/60
63	415	15	480Y/277	5	FAZ-K63/2	278804	1/60

SG07111



3-pole

0,5	415	15	480Y/277	5	FAZ-K0,5/3	278901	1/40
1	415	15	480Y/277	5	FAZ-K1/3	278902	1/40
1,6	415	15	480Y/277	5	FAZ-K1,6/3	278903	1/40
2	415	15	480Y/277	5	FAZ-K2/3	278904	1/40
3	415	15	480Y/277	5	FAZ-K3/3	278905	1/40
4	415	15	480Y/277	5	FAZ-K4/3	278906	1/40
6	415	15	480Y/277	5	FAZ-K6/3	278907	1/40
8	415	15	480Y/277	5	FAZ-K8/3	278908	1/40
10	415	15	480Y/277	5	FAZ-K10/3	278909	1/40
13	415	15	480Y/277	5	FAZ-K13/3	278910	1/40
16	415	15	480Y/277	5	FAZ-K16/3	278911	1/40
20	415	15	480Y/277	5	FAZ-K20/3	278912	1/40
25	415	15	480Y/277	5	FAZ-K25/3	278913	1/40
32	415	15	480Y/277	5	FAZ-K32/3	278914	1/40
40	415	15	480Y/277	5	FAZ-K40/3	278915	1/40
50	415	15	480Y/277	5	FAZ-K50/3	278916	1/40
63	415	15	480Y/277	5	FAZ-K63/3	278917	1/40

FAZ | Characteristic K

SG07311



Rated current I_n (A)	Rated voltage (V)	Breaking capacity acc. to IEC/EN 60947-2 (kA)	Rated voltage (V)	Breaking capacity acc. to UL1077 (kA)	Type Designation	Article No.	Units per package
----------------------------	----------------------	---	----------------------	--	---------------------	-------------	-------------------------

3+N-pole

0,5	415	15	480Y/277	5	FAZ-K0,5/3N	279003	1/30
1	415	15	480Y/277	5	FAZ-K1/3N	279004	1/30
1,6	415	15	480Y/277	5	FAZ-K1,6/3N	279005	1/30
2	415	15	480Y/277	5	FAZ-K2/3N	279006	1/30
3	415	15	480Y/277	5	FAZ-K3/3N	279007	1/30
4	415	15	480Y/277	5	FAZ-K4/3N	279008	1/30
6	415	15	480Y/277	5	FAZ-K6/3N	279009	1/30
8	415	15	480Y/277	5	FAZ-K8/3N	279010	1/30
10	415	15	480Y/277	5	FAZ-K10/3N	279011	1/30
13	415	15	480Y/277	5	FAZ-K13/3N	279012	1/30
16	415	15	480Y/277	5	FAZ-K16/3N	279013	1/30
20	415	15	480Y/277	5	FAZ-K20/3N	279014	1/30
25	415	15	480Y/277	5	FAZ-K25/3N	279015	1/30
32	415	15	480Y/277	5	FAZ-K32/3N	279016	1/30
40	415	15	480Y/277	5	FAZ-K40/3N	279017	1/30
50	415	15	480Y/277	5	FAZ-K50/3N	279018	1/30
63	415	15	480Y/277	5	FAZ-K63/3N	279019	1/30

SG07211



4-pole

0,5	415	15	480Y/277	5	FAZ-K0,5/4	279089	1/30
1	415	15	480Y/277	5	FAZ-K1/4	279090	1/30
1,6	415	15	480Y/277	5	FAZ-K1,6/4	279091	1/30
2	415	15	480Y/277	5	FAZ-K2/4	279092	1/30
3	415	15	480Y/277	5	FAZ-K3/4	279093	1/30
4	415	15	480Y/277	5	FAZ-K4/4	279094	1/30
6	415	15	480Y/277	5	FAZ-K6/4	279095	1/30
8	415	15	480Y/277	5	FAZ-K8/4	279096	1/30
10	415	15	480Y/277	5	FAZ-K10/4	279097	1/30
13	415	15	480Y/277	5	FAZ-K13/4	279098	1/30
16	415	15	480Y/277	5	FAZ-K16/4	279099	1/30
20	415	15	480Y/277	5	FAZ-K20/4	279100	1/30
25	415	15	480Y/277	5	FAZ-K25/4	279101	1/30
32	415	15	480Y/277	5	FAZ-K32/4	279102	1/30
40	415	15	480Y/277	5	FAZ-K40/4	279103	1/30
50	415	15	480Y/277	5	FAZ-K50/4	279104	1/30
63	415	15	480Y/277	5	FAZ-K63/4	279105	1/30

FAZ | Characteristic S

FAZ Miniature Circuit Breakers (MCBs) Characteristic S

SG06811



Rated current I_n (A)	Rated voltage (V)	Breaking capacity acc. to IEC/EN 60947-2 (kA)	Rated voltage UL1077 (V)	Breaking capacity acc. to UL1077 (kA)	Type Designation	Article No.	Units per package
----------------------------	----------------------	---	--------------------------------	--	---------------------	-------------	-------------------------

1-pole

1	240/415	10	277	5	FAZ-S1/1	278606	12/120
2	240/415	10	277	5	FAZ-S2/1	278607	12/120
3	240/415	10	277	5	FAZ-S3/1	278608	12/120
4	240/415	10	277	5	FAZ-S4/1	278609	12/120
6	240/415	10	277	5	FAZ-S6/1	278610	12/120
10	240/415	10	277	5	FAZ-S10/1	278611	12/120
16	240/415	10	277	5	FAZ-S16/1	278612	12/120
20	240/415	10	277	5	FAZ-S20/1	278613	12/120
25	240/415	10	277	5	FAZ-S25/1	278614	12/120
32	240/415	10	277	5	FAZ-S32/1	278615	12/120
40	240/415	10	277	5	FAZ-S40/1	278616	12/120

SG07011



2-pole

1	415	10	480Y/277	5	FAZ-S1/2	278805	1/60
2	415	10	480Y/277	5	FAZ-S2/2	278806	1/60
3	415	10	480Y/277	5	FAZ-S3/2	278807	1/60
4	415	10	480Y/277	5	FAZ-S4/2	278808	1/60
6	415	10	480Y/277	5	FAZ-S6/2	278809	1/60
10	415	10	480Y/277	5	FAZ-S10/2	278810	1/60
16	415	10	480Y/277	5	FAZ-S16/2	278811	1/60
20	415	10	480Y/277	5	FAZ-S20/2	278812	1/60
25	415	10	480Y/277	5	FAZ-S25/2	278813	1/60
32	415	10	480Y/277	5	FAZ-S32/2	278814	1/60
40	415	10	480Y/277	5	FAZ-S40/2	278815	1/60

FAZ | Characteristic Z

FAZ Miniature Circuit Breakers (MCBs) Characteristic Z

SG06811



Rated current I_n (A)	Rated voltage (V)	Breaking capacity acc. to IEC/EN 60947-2 (kA)	Rated voltage UL1077 (V)	Breaking capacity acc. to UL1077 (kA)	Type Designation	Article No.	Units per package
----------------------------	----------------------	---	--------------------------------	--	---------------------	-------------	-------------------------

1-pole

0,5	240/415	15	277	5	FAZ-Z0,5/1	278617	12/120
1	240/415	15	277	5	FAZ-Z1/1	278618	12/120
1,6	240/415	15	277	5	FAZ-Z1,6/1	278619	12/120
2	240/415	15	277	5	FAZ-Z2/1	278620	12/120
3	240/415	15	277	5	FAZ-Z3/1	278621	12/120
4	240/415	15	277	5	FAZ-Z4/1	278622	12/120
6	240/415	15	277	5	FAZ-Z6/1	278623	12/120
8	240/415	15	277	5	FAZ-Z8/1	278624	12/120
10	240/415	15	277	5	FAZ-Z10/1	278625	12/120
13	240/415	15	277	5	FAZ-Z13/1	106020	12/120
16	240/415	15	277	5	FAZ-Z16/1	278626	12/120
20	240/415	15	277	5	FAZ-Z20/1	278627	12/120
25	240/415	15	277	5	FAZ-Z25/1	278628	12/120
32	240/415	15	277	5	FAZ-Z32/1	278629	12/120
40	240/415	15	277	5	FAZ-Z40/1	278630	12/120
50	240/415	15	277	5	FAZ-Z50/1	278631	12/120
63	240/415	15	277	5	FAZ-Z63/1	278632	12/120

SG07011



2-pole

0,5	415	15	480Y/277	5	FAZ-Z0,5/2	278816	1/60
1	415	15	480Y/277	5	FAZ-Z1/2	278817	1/60
1,6	415	15	480Y/277	5	FAZ-Z1,6/2	278818	1/60
2	415	15	480Y/277	5	FAZ-Z2/2	278819	1/60
3	415	15	480Y/277	5	FAZ-Z3/2	278820	1/60
4	415	15	480Y/277	5	FAZ-Z4/2	278821	1/60
6	415	15	480Y/277	5	FAZ-Z6/2	278822	1/60
8	415	15	480Y/277	5	FAZ-Z8/2	278823	1/60
10	415	15	480Y/277	5	FAZ-Z10/2	278824	1/60
13	415	15	480Y/277	5	FAZ-Z13/2	106021	1/60
16	415	15	480Y/277	5	FAZ-Z16/2	278825	1/60
20	415	15	480Y/277	5	FAZ-Z20/2	278826	1/60
25	415	15	480Y/277	5	FAZ-Z25/2	278827	1/60
32	415	15	480Y/277	5	FAZ-Z32/2	278828	1/60
40	415	15	480Y/277	5	FAZ-Z40/2	278829	1/60
50	415	15	480Y/277	5	FAZ-Z50/2	278830	1/60
63	415	15	480Y/277	5	FAZ-Z63/2	278831	1/60

FAZ | Characteristic Z

SG07111



Rated current I_n (A)	Rated voltage (V)	Breaking capacity acc. to IEC/EN 60947-2 (kA)	Rated voltage (V)	Breaking capacity acc. to UL1077 (kA)	Type Designation	Article No.	Units per package
----------------------------	----------------------	---	----------------------	--	---------------------	-------------	-------------------------

3-pole

0,5	415	15	480Y/277	5	FAZ-Z0,5/3	278918	1/40
1	415	15	480Y/277	5	FAZ-Z1/3	278919	1/40
1,6	415	15	480Y/277	5	FAZ-Z1,6/3	278920	1/40
2	415	15	480Y/277	5	FAZ-Z2/3	278921	1/40
3	415	15	480Y/277	5	FAZ-Z3/3	278922	1/40
4	415	15	480Y/277	5	FAZ-Z4/3	278923	1/40
6	415	15	480Y/277	5	FAZ-Z6/3	278924	1/40
8	415	15	480Y/277	5	FAZ-Z8/3	278925	1/40
10	415	15	480Y/277	5	FAZ-Z10/3	278926	1/40
13	415	15	480Y/277	5	FAZ-Z13/3	106022	1/40
16	415	15	480Y/277	5	FAZ-Z16/3	278927	1/40
20	415	15	480Y/277	5	FAZ-Z20/3	278928	1/40
25	415	15	480Y/277	5	FAZ-Z25/3	278929	1/40
32	415	15	480Y/277	5	FAZ-Z32/3	278930	1/40
40	415	15	480Y/277	5	FAZ-Z40/3	278931	1/40
50	415	15	480Y/277	5	FAZ-Z50/3	278932	1/40
63	415	15	480Y/277	5	FAZ-Z63/3	278933	1/40

SG07211



4-pole

0,5	415	15	480Y/277	5	FAZ-Z0,5/4	279106	1/60
1	415	15	480Y/277	5	FAZ-Z1/4	279107	1/60
1,6	415	15	480Y/277	5	FAZ-Z1,6/4	279108	1/60
2	415	15	480Y/277	5	FAZ-Z2/4	279109	1/60
3	415	15	480Y/277	5	FAZ-Z3/4	279110	1/60
4	415	15	480Y/277	5	FAZ-Z4/4	279111	1/60
6	415	15	480Y/277	5	FAZ-Z6/4	279112	1/60
8	415	15	480Y/277	5	FAZ-Z8/4	279113	1/60
10	415	15	480Y/277	5	FAZ-Z10/4	279114	1/60
13	415	15	480Y/277	5	FAZ-Z13/4	106023	1/60
16	415	15	480Y/277	5	FAZ-Z16/4	279115	1/60
20	415	15	480Y/277	5	FAZ-Z20/4	279116	1/60
25	415	15	480Y/277	5	FAZ-Z25/4	279117	1/60
32	415	15	480Y/277	5	FAZ-Z32/4	279118	1/60
40	415	15	480Y/277	5	FAZ-Z40/4	279119	1/60
50	415	15	480Y/277	5	FAZ-Z50/4	279120	1/60
63	415	15	480Y/277	5	FAZ-Z63/4	279121	1/60

FAZ-PN | Characteristic B und C

FAZ-PN Miniature Circuit Breakers (MCBs)

Characteristic B

SG08311



Rated current I_n (A)	Rated voltage (V)	Breaking capacity acc. to IEC/EN 60898-1 (kA)	Breaking capacity acc. to IEC/EN 60947-2 (kA)	Type Designation	Article No.	Units per package
----------------------------	----------------------	---	---	---------------------	-------------	-------------------------

1+N-pole (1MU)

6	240	6	10	FAZ-PN-B6/1N	279146	12/120
10	240	6	10	FAZ-PN-B10/1N	279147	12/120
13	240	6	10	FAZ-PN-B13/1N	279148	12/120
16	240	6	10	FAZ-PN-B16/1N	279149	12/120
20	240	6	10	FAZ-PN-B20/1N	279150	12/120
25	240	6	10	FAZ-PN-B25/1N	279151	12/120
32	240	6	10	FAZ-PN-B32/1N	279152	12/120
40	240	6	10	FAZ-PN-B40/1N	279153	12/120

FAZ-PN Miniature Circuit Breakers (MCBs)

Characteristic C

SG08311





Rated current I_n (A)	Rated voltage (V)	Breaking capacity acc. to IEC/EN 60898-1 (kA)	Breaking capacity acc. to IEC/EN 60947-2 (kA)	Type Designation	Article No.	Units per package
----------------------------	----------------------	---	---	---------------------	-------------	-------------------------

1+N-pole (1MU)

2	240	6	10	FAZ-PN-C2/1N	279154	12/120
4	240	6	10	FAZ-PN-C4/1N	279155	12/120
6	240	6	10	FAZ-PN-C6/1N	279156	12/120
10	240	6	10	FAZ-PN-C10/1N	279157	12/120
13	240	6	10	FAZ-PN-C13/1N	279158	12/120
16	240	6	10	FAZ-PN-C16/1N	279159	12/120
20	240	6	10	FAZ-PN-C20/1N	279160	12/120
25	240	6	10	FAZ-PN-C25/1N	279161	12/120
32	240	6	10	FAZ-PN-C32/1N	279162	12/120
40	240	6	10	FAZ-PN-C40/1N	279163	12/120

FAZ-...-HS | Characteristic B

FAZ-...-HS Miniature Circuit Breakers (MCBs) Characteristic B

	Rated current I_n (A)	Rated voltage (V)	Breaking capacity acc. to IEC/EN 60898-1 (kA)	Type Designation	Article No.	Units per package
1-pole						
 <p>SG08411</p>	4	240	10	FAZ-B4/1-HS	279274	12/120
2-pole						
 <p>SG12911</p>	4	240	10	FAZ-B4/2-HS	279275	1/60

FAZ | Specifications

Specifications

Technical data

	B Curve	C Curve	D Curve
Electrical			
Approvals	UR (UL 1077), CSA (CSA 22.2 No. 235)		
Standards	IEC/EN 60947-2		
Short-circuit trip response	3–5 I_n	5–10 I_n	10–20 I_n
Supplementary Protectors—UL/CSA			
Current range	1–63A	0.5–63A	0.5–40A
Maximum voltage ratings—UL/CSA			
Single-pole	277 Vac 48 Vdc	277 Vac 48 Vdc	277 Vac 48 Vdc
Two-, three-pole	480Y/277 Vac	480Y/277 Vac	480Y/277 Vac
Two poles in series	96 Vdc	96 Vdc	96 Vdc
Thermal tripping characteristics			
Single-pole	1.35 x I_n @ 40°C	1.35 x I_n @ 40°C	1.35 x I_n @ 40°C
Multi-pole	1.45 x I_n @ 40°C	1.45 x I_n @ 40°C	1.45 x I_n @ 40°C
Short-circuit ratings (at max. voltage)			
Single-pole	10 kA (5 kA for 40–63A device)	10 kA (5 kA for 40–63A device)	5 kA
Two-, three-pole	10 kA (5 kA for 40–63A device)	10 kA (5 kA for 40–63A device)	5 kA
Single-pole	10 kA @ 48 Vdc	10 kA @ 48 Vdc	10 kA @ 48 Vdc
Two poles in series	10 kA @ 96 Vdc	10 kA @ 96 Vdc	10 kA @ 96 Vdc
Miniature Circuit Breaker—IEC			
Current range	1–63A	0.5–63A	0.5–63A
Maximum voltage ratings—IEC 60947-2			
Single-pole	230 Vac 48 Vdc	230 Vac 48 Vdc	230 Vac 48 Vdc
Two-, three-pole	230/400 Vac	230/400 Vac	230/400 Vac
Maximum Voltage Ratings—IEC 60898			
Single-pole	240 Vac 48 Vdc	240 Vac 48 Vdc	240 Vac 48 Vdc
Two-, three-pole	240/415 Vac	240/415 Vac	240/415 Vac
Thermal tripping characteristics			
Single-pole	> 1 hour @ 1.05 x I_n	> 1 hour @ 1.05 x I_n	> 1 hour @ 1.05 x I_n
Multi-pole	< 1 hour @ 1.3 x I_n	< 1 hour @ 1.3 x I_n	< 1 hour @ 1.3 x I_n
Interrupt ratings (at max. voltage)			
IEC 60947-2	15 kA	15 kA	15 kA
IEC 60898	10 kA	10 kA	10 kA
Operational switching capacity	7.5 kA	7.5 kA	7.5 kA
Max. back-up fuse [gL/gG]	125A	125A	125A
Rated impulse withstand— U_{imp}	4000 Vac	4000 Vac	4000 Vac
Rated insulation voltage— U_i	440 Vac	440 Vac	440 Vac
Environmental/General			
Selectivity class	3	3	3
Lifespan (operations)	> 10000 (1 operation = ON/OFF)	> 10000 (1 operation = ON/OFF)	> 10000 (1 operation = ON/OFF)
Shock (IEC 68-2-22)	10g–120 ms	10g–120 ms	10g–120 ms
Operating temperature range	-40 to +75°C	-40 to +75°C	-40 to +75°C
Mechanical			
Standard front dimension			
Device height	80 mm	80 mm	80 mm
Terminal protection	Finger and back-of-hand proof	Finger and back-of-hand proof	Finger and back-of-hand proof
Mounting width per pole	17.5 mm	17.5 mm	17.5 mm
Mounting	IEC/EN 60715 top-hat rail	IEC/EN 60715 top-hat rail	IEC/EN 60715 top-hat rail
Degree of protection	IP20	IP20	IP20
Terminals top and bottom	Twin-purpose terminals	Twin-purpose terminals	Twin-purpose terminals
Supply connection	Line or load side	Line or load side	Line or load side
Terminal capacity [mm ²]	1 x 25 / 2 x 10	1 x 25 / 2 x 10	1 x 25 / 2 x 10
Torque	2.4 Nm	2.4 Nm	2.4 Nm
Thickness of busbar material	0.8–2 mm	0.8–2 mm	0.8–2 mm
Mounting position	As required	As required	As required

Specifications

Technical Data (continued)

	K Curve	S Curve	Z Curve
Electrical			
Approvals	UR (UL 1077), CSA (CSA 22.2 No. 235), CE, VDE		
Standards	IEC/EN 60947-2		
Short-circuit trip response	8–12 I_n	13–17 I_n	2–3 I_n
Supplementary Protectors—UL/CSA			
Current range	0.5–63A	0.5–40A	1–63A
Maximum voltage ratings—UL/CSA			
Single-pole, single-pole + neutral	277 Vac 48 Vdc	277 Vac 48 Vdc	277 Vac 48 Vdc
Two-, three-, four-pole and three-pole + neutral	480Y/277 Vac	480Y/277 Vac	480Y/277 Vac
Two poles in series	96 Vdc	96 Vdc	96 Vdc
Thermal tripping characteristics			
Single-pole	1.35 x I_n @ 40°C	1.35 x I_n @ 40°C	1.35 x I_n @ 40°C
Multi-pole	1.45 x I_n @ 40°C	1.45 x I_n @ 40°C	1.45 x I_n @ 40°C
Short-circuit ratings (at max. voltage)			
Single-pole	5 kA @ 277 Vac	5 kA @ 277 Vac	5 kA @ 277 Vac
Single-pole + neutral	5 kA @ 277 Vac	5 kA @ 277 Vac	5 kA @ 277 Vac
Two-, three-, four-pole	5 kA @ 480Y/277 Vac	5 kA @ 480Y/277 Vac	5 kA @ 480Y/277 Vac
Miniature Circuit Breaker—IEC			
Current range	0.5–63A	0.5–40A	1–63A
Maximum voltage ratings—IEC 60947-2			
Single-pole, single-pole + neutral	240 Vac	240 Vac	240 Vac
Two-, three-, four-pole, three-pole + neutral	240/415 Vac	240/415 Vac	240/415 Vac
Thermal tripping characteristics			
Single-pole	> 1 hour @ 1.05 x I_n	> 1 hour @ 1.05 x I_n	> 1 hour @ 1.05 x I_n
Multi-pole	< 1 hour @ 1.3 x I_n	< 1 hour @ 1.3 x I_n	< 1 hour @ 1.3 x I_n
Interrupt ratings (at max. voltage)			
IEC 60947-2	15 kA	10 kA	10 kA
IEC 60898	15 kA	10 kA	10 kA
Operational switching capacity	7.5 kA	7.5 kA	7.5 kA
Max. back-up fuse [gL/gG]	125A	125A	125A
Rated impulse withstand— U_{imp}	4000 Vac	4000 Vac	4000 Vac
Rated insulation voltage— U_i	440 Vac	440 Vac	440 Vac
Environmental/General			
Selectivity class	3	3	3
Lifespan (operations)	> 10000 (1 operation = ON/OFF)	> 10000 (1 operation = ON/OFF)	> 10000 (1 operation = ON/OFF)
Shock (IEC 68-2-22)	10g–120 ms	10g–120 ms	10g–120 ms
Operating temperature range	-5 to +40°C	-5 to +40°C	-5 to +40°C
Mechanical			
Standard front dimension			
Device height	80 mm	80 mm	80 mm
Terminal protection	Finger and back-of-hand proof	Finger and back-of-hand proof	Finger and back-of-hand proof
Mounting width per pole	17.5 mm	17.5 mm	17.5 mm
Mounting	IEC/EN 60715 top-hat rail	IEC/EN 60715 top-hat rail	IEC/EN 60715 top-hat rail
Degree of protection	IP20	IP20	IP20
Terminals top and bottom	Twin-purpose terminals	Twin-purpose terminals	Twin-purpose terminals
Supply connection	Line or load side	Line or load side	Line or load side
Terminal capacity [mm ²]	1 x 25 / 2 x 10	1 x 25 / 2 x 10	1 x 25 / 2 x 10
Torque	2.4 Nm	2.4 Nm	2.4 Nm
Thickness of busbar material	0.8–2 mm	0.8–2 mm	0.8–2 mm
Mounting position	As required	As required	As required

Connection diagrams

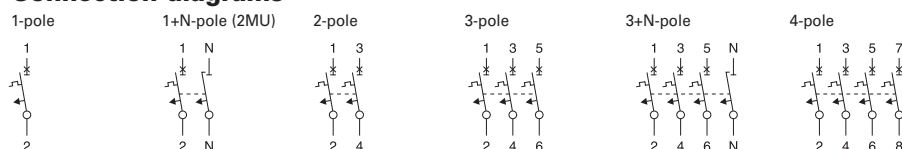

FAZ | Specifications

Dimensions (mm) FAZ

1-pole

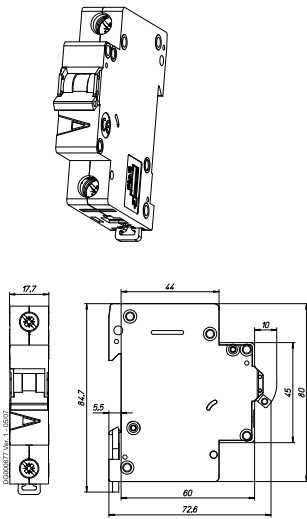

1+N-pole, 2-pole

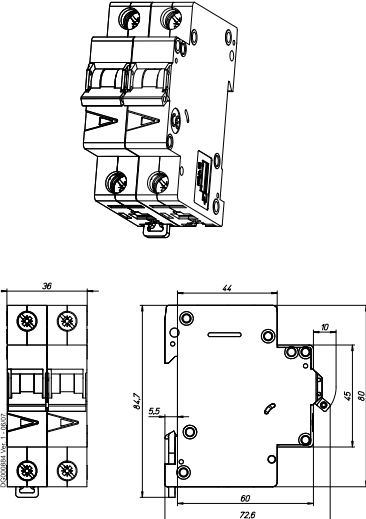

3-pole

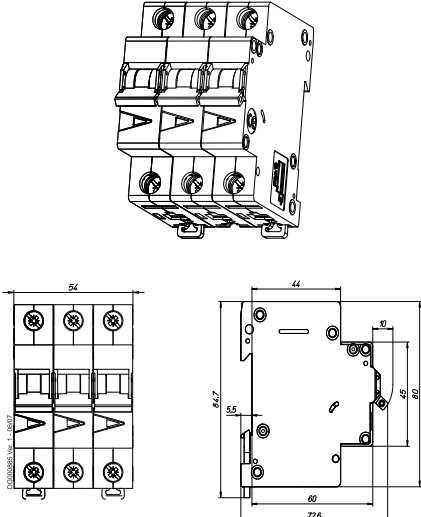

3+N-pole, 4-pole

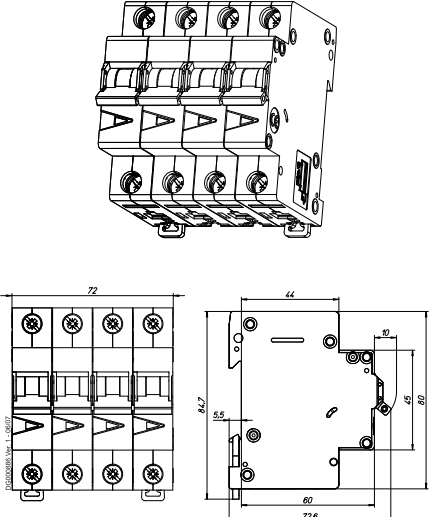

Tripping Characteristic FAZ

Characteristics B, C and D - IEC/EN60898-1

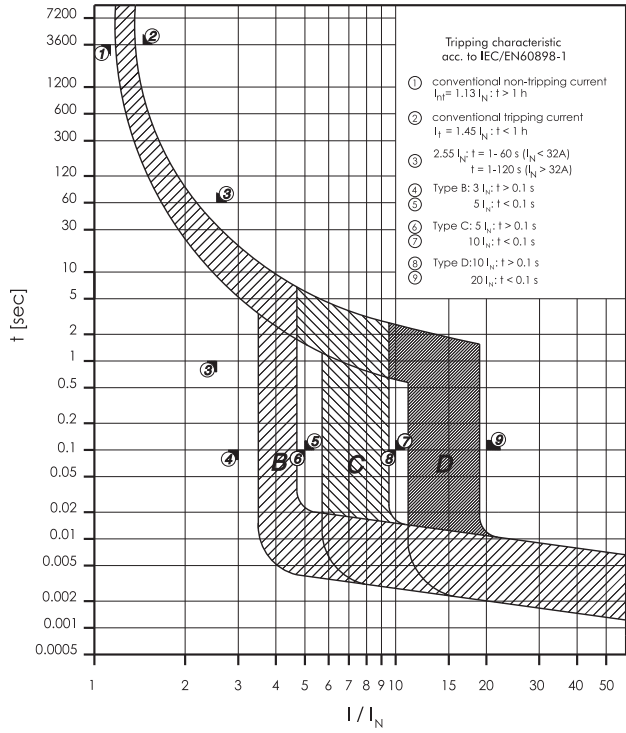

Characteristic K - IEC/EN 60947-2

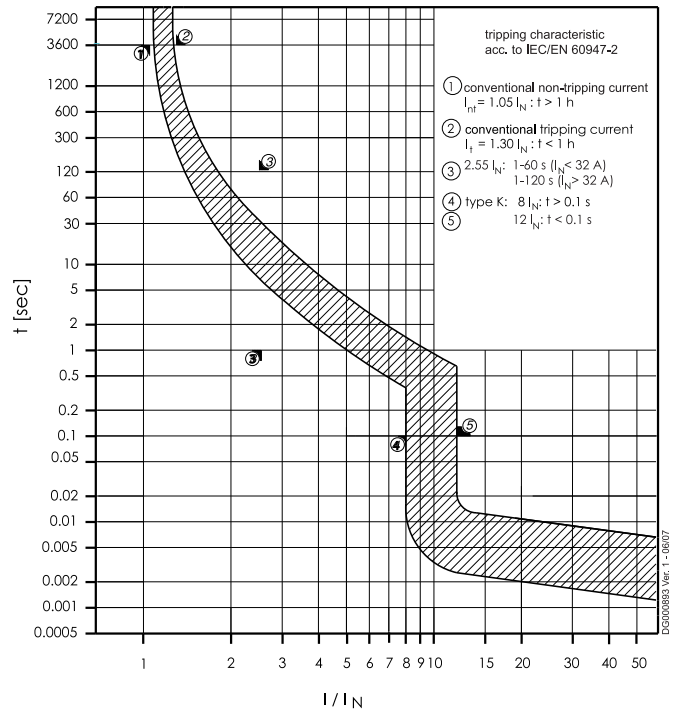

Characteristic S - IEC/EN 60947-2

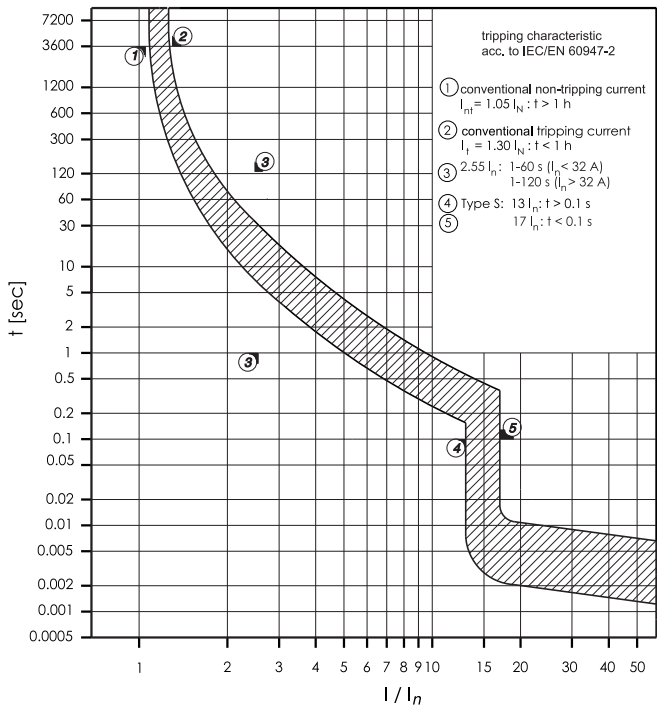

Characteristic S - UL1077

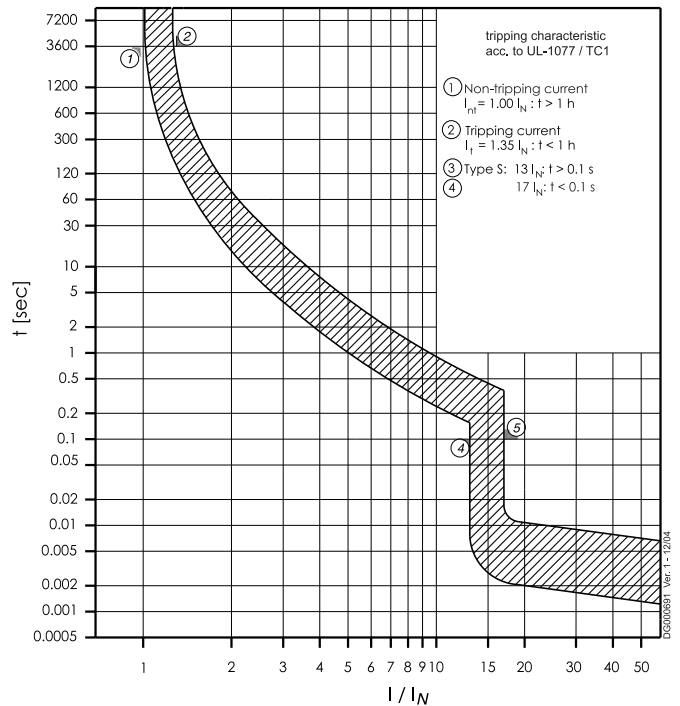

Tripping Characteristic FAZ

Characteristic Z - IEC/EN 60947-2

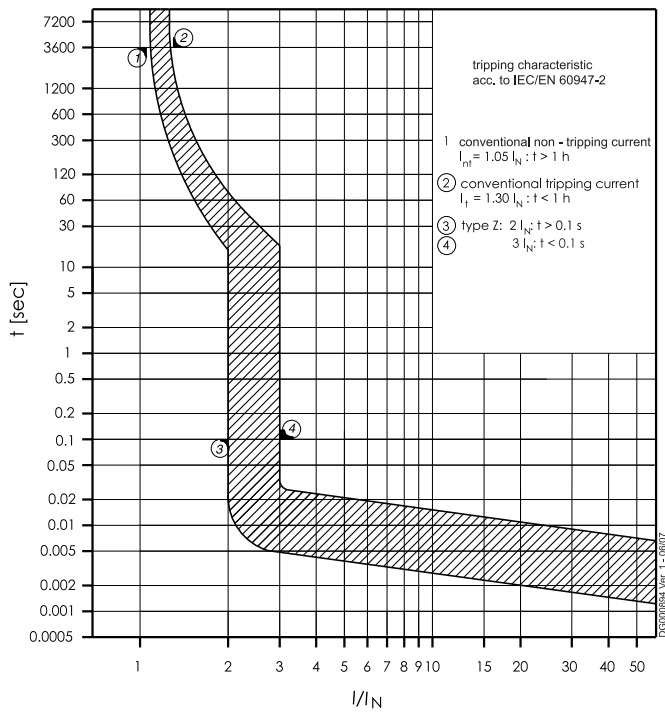

Characteristic Z - UL1077

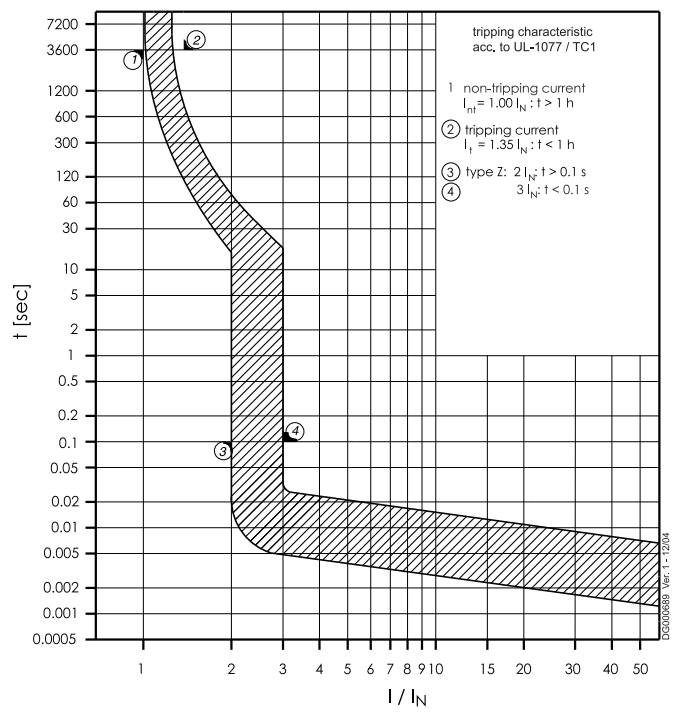

FAZ | Specifications

Internal Resistance FAZ

Type B

At room temperature (single pole)

In [A]	Z* [mΩ]	R [mΩ]
1	1120	1102
1.5	922	912
1.6	922	912
2	335	333
2.5	234	230
3	211	208
3.5	184	180
4	87.7	87.2
5	73.5	72.8
6	46.8	46.3
8	30.5	30.4
10	17.5	17.4
12	16.9	16.8
13	13.4	13.3
15	8.0	7.9
16	8.0	7.9
20	7.2	7.1
25	5.0	4.9
32	3.7	3.7
40	2.6	2.5
50	2.1	2.1
63	2.0	2.0

* 50Hz

Type C

At room temperature (single pole)

In [A]	Z* [mΩ]	R [mΩ]
0.16	68500	68300
0.25	27500	27400
0.5	4680	4670
0.75	2280	2250
1	1120	1100
1.5	589	587
1.6	589	587
2	335	333
2.5	234	230
3	131	130
3.5	143	141
4	87.7	87.2
5	73.5	72.8
6	39.3	39.1
8	30.5	30.4
10	14.1	14.0
12	13.5	13.4
13	13.4	13.3
15	8.0	7.9
16	8.0	7.9
20	7.2	7.1
25	5.0	4.9
32	3.7	3.7
40	2.6	2.5
50	2.1	2.1
63	2.0	2.0

* 50Hz

Type D

At room temperature (single pole)

In [A]	Z* [mΩ]	R [mΩ]
0.5	4680	4670
1	772	770
1.5	512	508
1.6	512	508
2	250	249
2.5	153	153
3	131	130
3.5	143	141
4	87.7	87.2
5	65.4	65.1
6	39.3	39.1
8	19.5	19.5
10	14.1	14.0
12	11.3	11.2
13	10.1	10.1
15	8.0	7.9
16	8.0	7.9
20	4.9	4.9
25	3.9	3.8
32	3.5	3.4
40	2.7	2.6

* 50Hz

FAZ | Specifications

Fault Loop Impedance FAZ

Max. allowed value for the Fault Loop Impedance Z_s
(acc. to DIN VDE 0100, part 410)

$U_0 = 230 \text{ V}$

Tripping time I_n/A	Type B		Type C		Type D	
	0,4s $Z_s (\Omega)$	5s $Z_s (\Omega)$	0,4s $Z_s (\Omega)$	5s $Z_s (\Omega)$	0,4s $Z_s (\Omega)$	5s $Z_s (\Omega)$
1	40,4	40,4	24,3	40,4	12,4	40,4
1,5	26,9	26,9	16,2	26,9	8,3	26,9
2	20,2	20,2	12,2	20,2	6,2	20,2
2,5	16,1	16,1	9,7	16,1	5,0	16,1
3	13,5	13,5	8,1	13,5	4,1	13,5
3,5	11,5	11,5	7,0	11,5	3,6	11,5
4	10,1	10,1	6,1	10,1	3,1	10,1
5	8,1	8,1	4,9	8,1	2,5	8,1
6	6,7	6,7	4,1	6,7	2,1	6,7
8	5,0	5,0	3,0	5,0	1,6	5,0
10	4,0	4,0	2,4	4,0	1,2	4,0
12	3,4	3,4	2,0	3,4	1,0	3,4
13	3,1	3,1	1,9	3,1	1,0	3,1
15	2,7	2,7	1,6	2,7	0,8	2,7
16	2,5	2,5	1,5	2,5	0,8	2,5
20	2,0	2,0	1,2	2,0	0,6	2,0
25	1,6	1,6	1,0	1,6	0,5	1,6
32	1,3	1,3	0,8	1,3	0,4	1,3
40	1,0	1,0	0,6	1,0	0,3	1,0
50	0,8	0,8	0,5	0,8	0,2	0,8
63	0,6	0,6	0,4	0,6	0,2	0,6

$$Z_s = R_{M.C.B.} + R_{Loop}$$

Data/factors taken from the time-current characteristic FAZ

For other rated voltages U_0 :

$U_0 = 240 \text{ V}$: $Z_s * 1,04$ applies

$U_0 = 127 \text{ V}$: $Z_s * 0,55$ applies

FAZ | Specifications

Power Loss at I_n FAZ

Type B

I_n [A]	1p	1pN	2p	3p	3pN*
	P [W]	P [W]	P [W]	P [W]	P [W]
1	1.6	1.7	3.1	4.7	4.8
1.5	2.3	2.5	4.6	6.9	7.2
1.6	2.5	2.7	4.9	7.4	7.6
2	1.4	1.5	2.8	4.1	4.3
2.5	1.5	1.7	3.1	4.6	4.7
3	2.5	2.7	5.0	7.6	7.8
3.5	2.5	2.8	5.1	7.8	8.0
4	1.4	1.6	2.9	4.4	4.5
5	1.9	2.1	3.8	5.8	6.0
6	1.8	2.0	3.6	5.5	5.6
8	2.1	2.3	4.1	6.3	6.5
10	1.9	2.1	3.9	5.9	6.1
12	2.8	3.2	5.9	8.7	9.0
13	2.5	2.9	5.3	7.8	8.1
15	2.1	2.4	4.4	6.5	6.7
16	2.2	2.6	4.7	6.9	7.2
20	3.2	3.6	6.6	9.8	10.1
25	3.0	3.5	6.4	9.4	9.7
32	3.7	4.4	8.1	12.1	12.5
40	3.4	4.1	7.5	11.2	11.5
50	4.5	5.4	9.9	14.9	15.3
63	5.2	6.3	11.5	17.2	17.7

*symmetrical load

Type C

I_n [A]	1p	1pN	2p	3p	3pN*
	P [W]	P [W]	P [W]	P [W]	P [W]
0.16	2.2	2.4	4.4	6.7	6.9
0.25	2.0	2.2	4.0	6.1	6.3
0.5	1.2	1.3	2.4	3.5	3.7
0.75	1.3	1.4	2.6	3.9	4.1
1	1.6	1.7	3.1	4.7	4.8
1.5	1.5	1.6	2.9	4.4	4.6
1.6	1.6	1.7	3.1	4.7	4.9
2	1.4	1.5	2.8	4.1	4.3
2.5	1.5	1.7	3.1	4.6	4.7
3	1.2	1.3	2.4	3.6	3.7
3.5	1.3	1.4	2.6	3.9	4.0
4	1.4	1.6	2.9	4.4	4.5
5	1.9	2.1	3.8	5.8	6.0
6	1.5	1.6	2.9	4.4	4.6
8	2.1	2.3	4.1	6.3	6.5
10	1.5	1.7	3.0	4.6	4.7
12	2.1	2.4	4.4	6.5	6.8
13	2.5	2.9	5.3	7.8	8.1
15	2.1	2.4	4.4	6.5	6.7
16	2.2	2.6	4.7	6.9	7.2
20	3.2	3.6	6.6	9.8	10.1
25	3.0	3.5	6.4	9.4	9.7
32	3.7	4.4	8.1	12.1	12.5
40	3.4	4.1	7.5	11.2	11.5
50	4.5	5.4	9.9	14.9	15.3
63	5.2	6.3	11.5	17.2	17.7

*symmetrical load

Type D

I_n [A]	1p	1pN	2p	3p	3pN*
	P [W]	P [W]	P [W]	P [W]	P [W]
0.5	1.2	1.3	2.4	3.5	3.7
1	0.8	0.9	1.6	2.4	2.5
1.5	1.2	1.3	2.3	3.5	3.6
1.6	1.3	1.4	2.5	3.8	3.9
2	1.0	1.1	2.0	3.0	3.1
2.5	1.0	1.1	1.9	2.9	3.0
3	1.2	1.3	2.4	3.6	3.7
3.5	1.3	1.4	2.6	3.9	4.0
4	1.4	1.6	2.9	4.4	4.5
5	1.7	1.8	3.3	5.1	5.3
6	1.5	1.6	2.9	4.4	4.6
8	1.3	1.5	2.6	4.0	4.2
10	1.5	1.7	3.0	4.6	4.7
12	1.7	2.0	3.6	5.3	5.4
13	1.9	2.2	4.0	5.9	6.1
15	2.1	2.4	4.4	6.5	6.7
16	2.2	2.6	4.7	6.9	7.2
20	2.0	2.2	4.1	6.1	6.2
25	2.5	2.9	5.2	7.7	7.9
32	3.4	4.0	7.4	11.1	11.4
40	3.2	3.8	7.0	10.4	10.7

*symmetrical load

FAZ | Specifications

Influence of Ambient Temperature FAZ

On Load Carrying Capacity (temperature derating)

I _N [A]	Ambient temperature T [°C]																
	-40	-30	-20	-10	0	10	20	30	35	40	45	50	55	60	65	70	75
0,16	0,2	0,2	0,19	0,19	0,18	0,17	0,17	0,16	0,16	0,15	0,15	0,15	0,14	0,14	0,14	0,14	0,13
0,25	0,32	0,31	0,3	0,29	0,28	0,27	0,26	0,25	0,25	0,24	0,24	0,23	0,23	0,22	0,22	0,21	0,21
0,5	0,64	0,62	0,6	0,58	0,56	0,54	0,52	0,5	0,49	0,48	0,47	0,46	0,45	0,44	0,43	0,42	0,41
0,75	0,96	0,93	0,9	0,87	0,84	0,81	0,78	0,75	0,74	0,73	0,71	0,69	0,68	0,66	0,65	0,64	0,62
1	1,3	1,2	1,2	1,2	1,1	1,1	1	1	0,99	0,97	0,95	0,93	0,9	0,89	0,87	0,85	0,83
1,5	1,9	1,9	1,8	1,7	1,7	1,6	1,6	1,5	1,5	1,5	1,4	1,4	1,4	1,3	1,3	1,3	1,2
1,6	2	2	1,9	1,9	1,8	1,7	1,7	1,6	1,6	1,5	1,5	1,5	1,4	1,4	1,4	1,4	1,3
2	2,6	2,5	2,4	2,3	2,2	2,2	2,1	2	2	1,9	1,9	1,9	1,8	1,8	1,7	1,7	1,7
2,5	3,2	3,1	3	2,9	2,8	2,7	2,6	2,5	2,5	2,4	2,4	2,3	2,3	2,2	2,2	2,1	2,1
3	3,8	3,7	3,6	3,5	3,4	3,3	3,1	3	3	2,9	2,8	2,8	2,7	2,7	2,6	2,5	2,5
3,5	4,5	4,4	4,2	4,1	3,9	3,8	3,7	3,5	3,4	3,4	3,3	3,2	3,2	3,1	3	3	2,9
4	5,1	5	4,8	4,7	4,5	4,3	4,2	4	3,9	3,9	3,8	3,7	3,6	3,5	3,5	3,4	3,3
5	6,4	6,2	6	5,8	5,6	5,4	5,2	5	4,9	4,8	4,7	4,6	4,5	4,4	4,3	4,2	4,1
6	7,7	7,5	7,2	7	6,7	6,5	6,3	6	5,9	5,8	5,7	5,6	5,4	5,3	5,2	5,1	5
8	10,2	9,9	9,6	9,3	9	8,7	8,4	8	7,9	7,7	7,6	7,4	7,2	7,1	6,9	6,8	6,6
10	13	12	12	12	11	11	10	10	9,9	9,7	9,5	9,3	9	8,9	8,7	8,5	8,3
12	15	15	14	14	13	13	13	12	12	12	11	11	11	11	10	10	10
13	17	16	16	15	15	14	14	13	13	13	12	12	12	12	11	11	11
15	19	19	18	17	17	16	16	15	15	15	14	14	14	13	13	13	12
16	20	20	19	19	18	17	17	16	16	15	15	15	14	14	14	14	13
20	26	25	24	23	22	22	21	20	20	19	19	19	18	18	17	17	17
25	32	31	30	29	28	27	26	25	25	24	24	23	23	22	22	21	21
32	41	40	38	37	36	35	33	32	32	31	30	30	29	28	28	27	26
40	51	50	48	47	45	43	42	40	39	39	38	37	36	35	35	34	33
50	64	62	60	58	56	54	52	50	49	48	47	46	45	44	43	42	41
63	81	78	76	73	71	68	66	63	62	61	60	58	57	56	55	53	52

Maximum Let-Through Energy FAZ

Type S

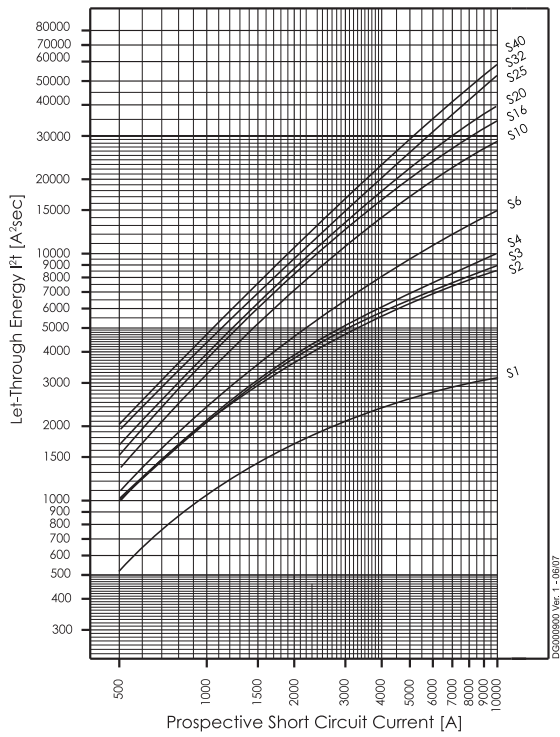

Type Z

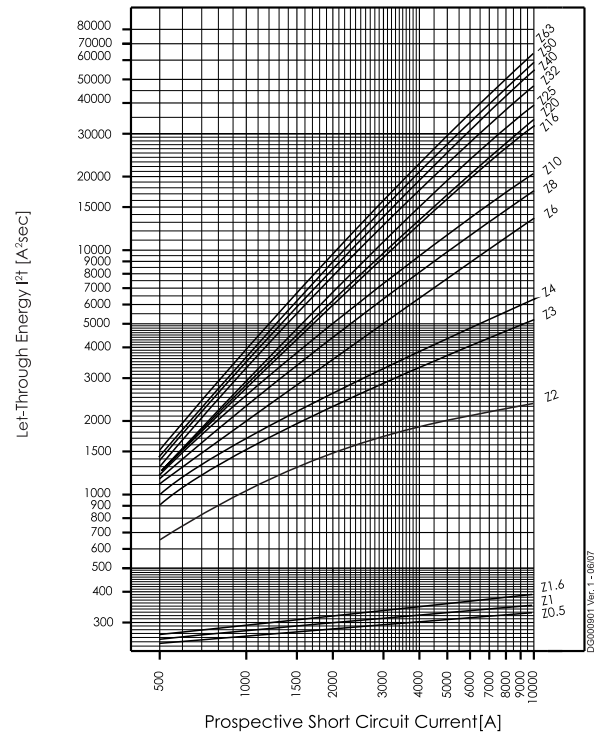

Type FAZ-...-HS

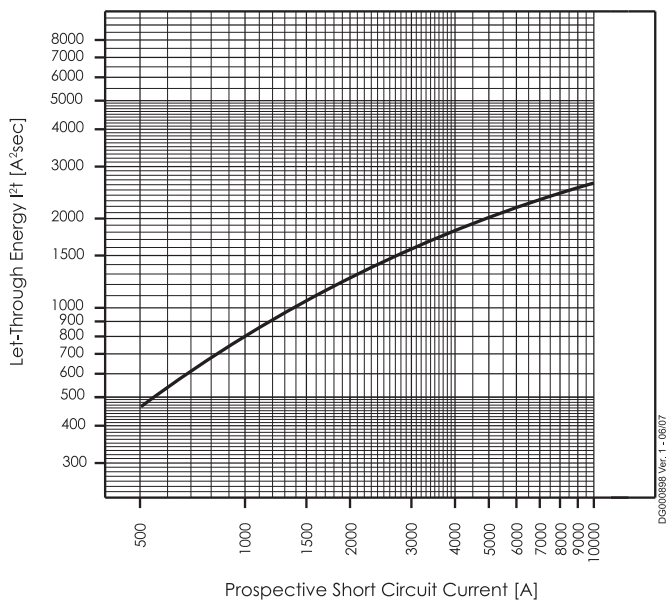

FAZ | Specifications

Maximum Let-Through Current FAZ

Type B (IEC/EN60898)

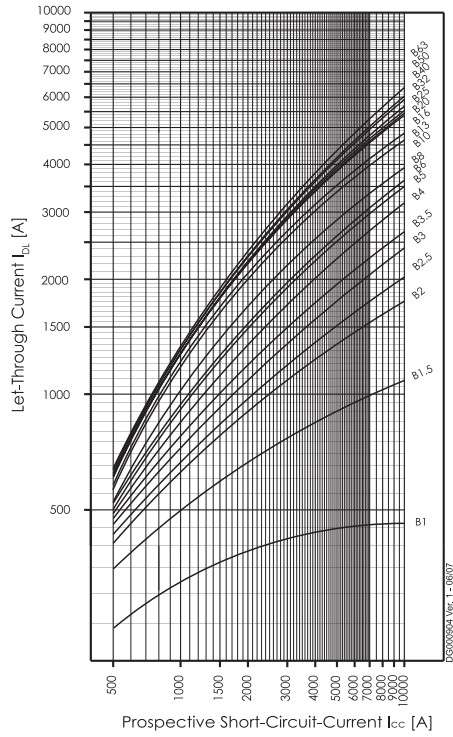

Type C (IEC/EN60898)

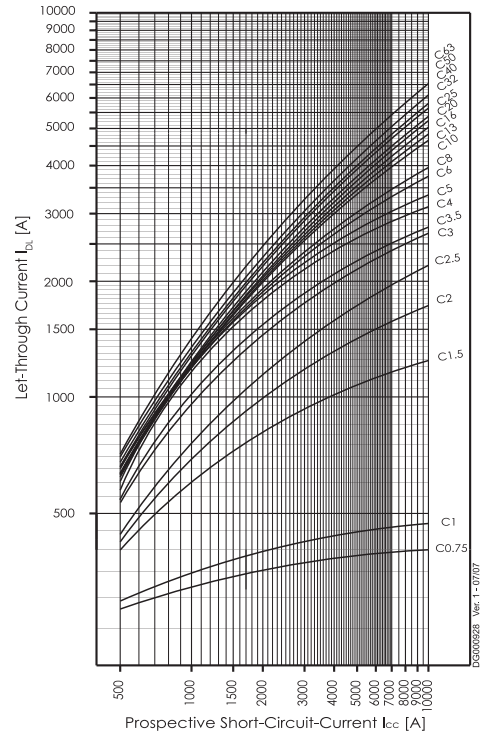

Type D (IEC/EN60898)

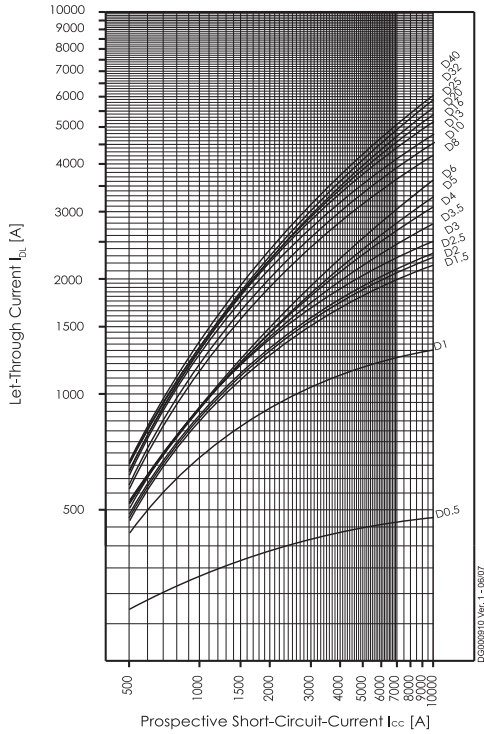

Type K

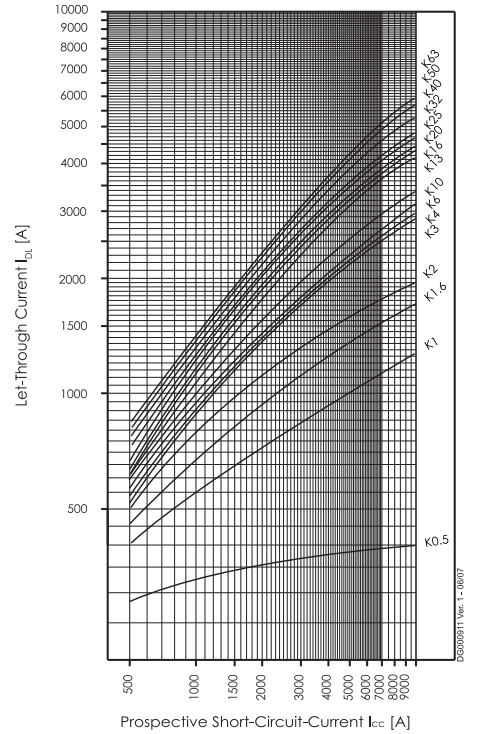

Maximum Let-Through Current FAZ

Type S

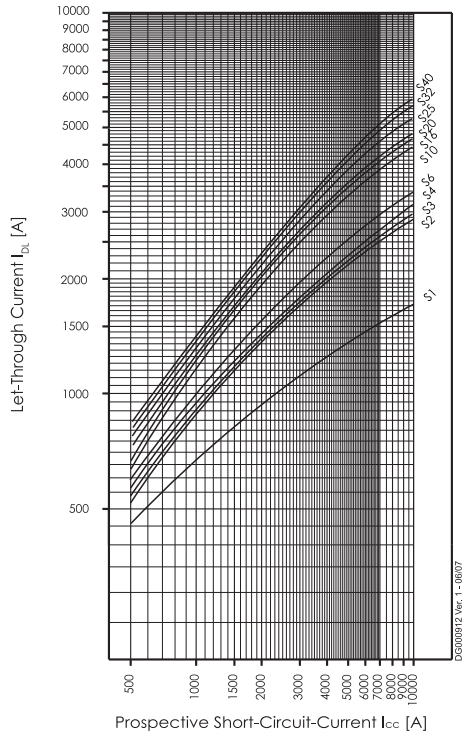

Type B (IEC/EN60947-2)

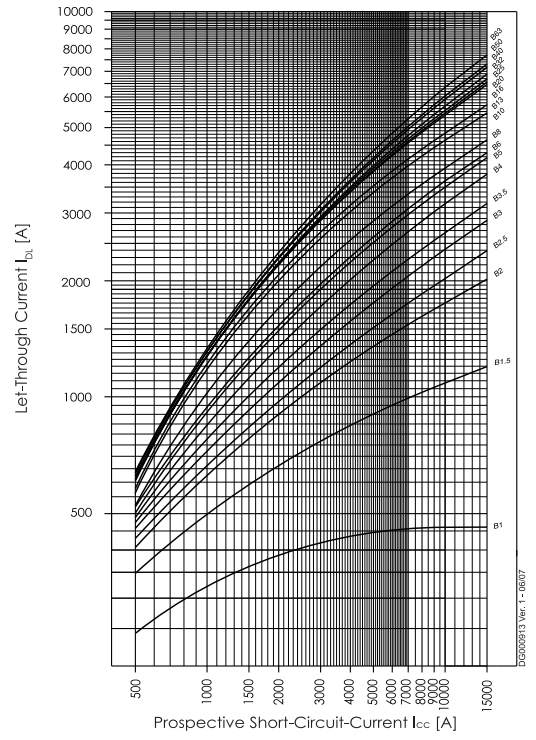

Type C (IEC/EN60947-2)

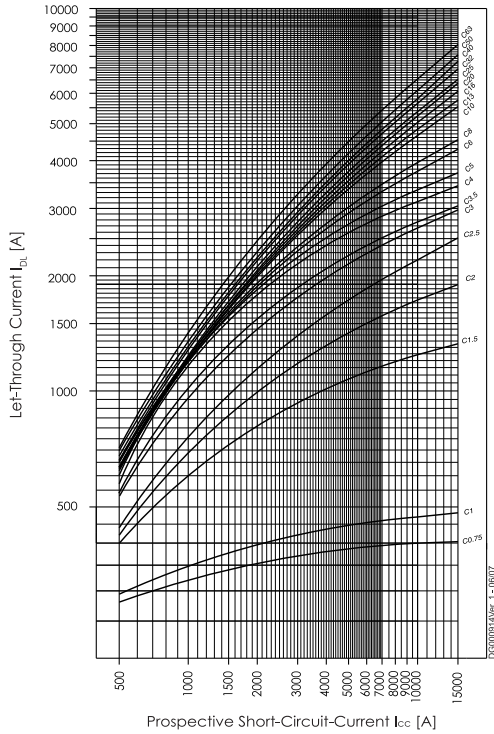

Type D (IEC/EN60947-2)

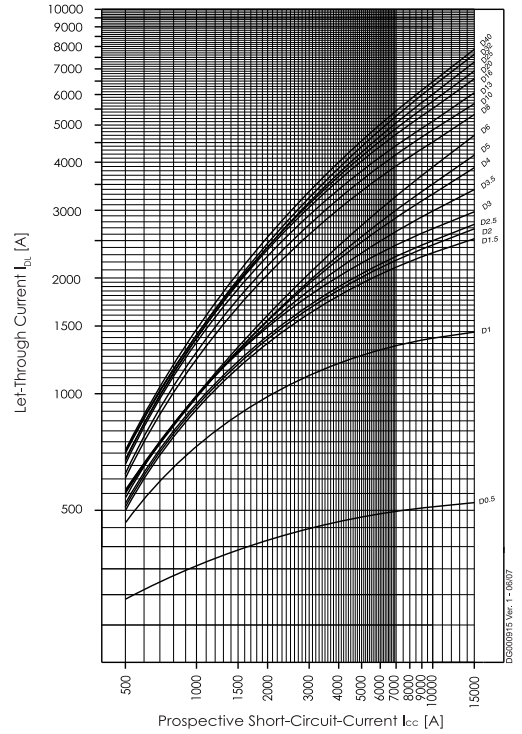

FAZ | Specifications

Short Circuit Selectivity FAZ towards NH-00 Fuses



In case of short circuit, there is selectivity between the miniature circuit breakers FAZ and the upstream fuses up to the specified values of the selectivity limit current I_s [kA] (i. e. in case of short-circuit currents I_{ks} under I_s , only the MCB will trip, in case of short circuit currents above this value both protective devices will respond).

*) basically in accordance with EN 60898-1 D.5.2.b

Short circuit selectivity **characteristic B** towards fuse link **NH-00***)

FAZ	NH-00 gL/gG											
I_n [A]	16	20	25	32	35	40	50	63	80	100	125	160
1.0	0.9	10.0 ²⁾	10.0 ²⁾	10.0 ²⁾	10.0 ²⁾	10.0 ²⁾	10.0 ²⁾	10.0 ²⁾	10.0 ²⁾	10.0 ²⁾	10.0 ²⁾	10.0 ²⁾
1.5	0.8	10.0 ²⁾	10.0 ²⁾	10.0 ²⁾	10.0 ²⁾	10.0 ²⁾	10.0 ²⁾	10.0 ²⁾	10.0 ²⁾	10.0 ²⁾	10.0 ²⁾	10.0 ²⁾
2.0	<0.5 ¹⁾	0.5	1.0	2.5	10.0 ²⁾	10.0 ²⁾	10.0 ²⁾	10.0 ²⁾	10.0 ²⁾	10.0 ²⁾	10.0 ²⁾	10.0 ²⁾
2.5	<0.5 ¹⁾	0.5	1.0	2.3	10.0 ²⁾	10.0 ²⁾	10.0 ²⁾	10.0 ²⁾	10.0 ²⁾	10.0 ²⁾	10.0 ²⁾	10.0 ²⁾
3.0	<0.5 ¹⁾	0.5	0.9	2.1	8.0	10.0 ²⁾	10.0 ²⁾	10.0 ²⁾	10.0 ²⁾	10.0 ²⁾	10.0 ²⁾	10.0 ²⁾
3.5	<0.5 ¹⁾	0.5	0.9	1.8	5.5	10.0 ²⁾	10.0 ²⁾	10.0 ²⁾	10.0 ²⁾	10.0 ²⁾	10.0 ²⁾	10.0 ²⁾
4	<0.5 ¹⁾	<0.5 ¹⁾	0.8	1.3	2.3	4.3	10.0 ²⁾	10.0 ²⁾	10.0 ²⁾	10.0 ²⁾	10.0 ²⁾	10.0 ²⁾
5	<0.5 ¹⁾	<0.5 ¹⁾	0.7	1.1	1.6	2.2	3.6	4.8	8.9	10.0 ²⁾	10.0 ²⁾	10.0 ²⁾
6	<0.5 ¹⁾	<0.5 ¹⁾	0.7	1.1	1.5	2.0	3.3	4.3	7.6	10.0 ²⁾	10.0 ²⁾	10.0 ²⁾
8	<0.5 ¹⁾	<0.5 ¹⁾	0.6	1.0	1.3	1.7	2.6	3.3	5.2	10.0 ²⁾	10.0 ²⁾	10.0 ²⁾
10		<0.5 ¹⁾	0.6	0.9	1.2	1.5	2.2	2.7	4.0	9.0	10.0 ²⁾	10.0 ²⁾
13		<0.5 ¹⁾	0.6	0.8	1.1	1.4	2.1	2.6	3.8	7.9	10.0 ²⁾	10.0 ²⁾
16			0.5	0.7	1.0	1.3	1.9	2.4	3.4	6.4	9.3	10.0 ²⁾
20				0.7	1.0	1.3	1.9	2.4	3.3	6.0	8.7	10.0 ²⁾
25				0.7	1.0	1.3	1.8	2.3	3.2	5.7	8.0	10.0 ²⁾
32					0.9	1.2	1.7	2.2	3.1	5.4	7.6	10.0 ²⁾
40								2.1	3.0	5.1	7.2	10.0 ²⁾
50								1.9	2.8	4.7	6.6	9.5
63									4.4	6.3	8.6	

Short circuit selectivity **characteristic C** towards fuse link **NH-00***)

FAZ	NH-00 gL/gG											
I_n [A]	16	20	25	32	35	40	50	63	80	100	125	160
0.75	10.0 ²⁾	10.0 ²⁾	10.0 ²⁾	10.0 ²⁾	10.0 ²⁾	10.0 ²⁾	10.0 ²⁾	10.0 ²⁾	10.0 ²⁾	10.0 ²⁾	10.0 ²⁾	10.0 ²⁾
1.0	0.9	10.0 ²⁾	10.0 ²⁾	10.0 ²⁾	10.0 ²⁾	10.0 ²⁾	10.0 ²⁾	10.0 ²⁾	10.0 ²⁾	10.0 ²⁾	10.0 ²⁾	10.0 ²⁾
1.5	<0.5 ¹⁾	0.6	1.3	4.2	10.0 ²⁾	10.0 ²⁾	10.0 ²⁾	10.0 ²⁾	10.0 ²⁾	10.0 ²⁾	10.0 ²⁾	10.0 ²⁾
2.0	<0.5 ¹⁾	0.6	1.0	2.5	10.0 ²⁾	10.0 ²⁾	10.0 ²⁾	10.0 ²⁾	10.0 ²⁾	10.0 ²⁾	10.0 ²⁾	10.0 ²⁾
2.5	<0.5 ¹⁾	0.5	1.0	2.1	10.0 ²⁾	10.0 ²⁾	10.0 ²⁾	10.0 ²⁾	10.0 ²⁾	10.0 ²⁾	10.0 ²⁾	10.0 ²⁾
3.0	<0.5 ¹⁾	<0.5 ¹⁾	0.7	1.2	1.8	2.6	4.7	6.6	10.0 ²⁾	10.0 ²⁾	10.0 ²⁾	10.0 ²⁾
3.5	<0.5 ¹⁾	<0.5 ¹⁾	0.7	1.1	1.7	2.4	4.2	6.0	10.0 ²⁾	10.0 ²⁾	10.0 ²⁾	10.0 ²⁾
4	<0.5 ¹⁾	<0.5 ¹⁾	0.7	1.0	1.5	2.1	3.6	5.0	10.0	10.0 ²⁾	10.0 ²⁾	10.0 ²⁾
5	<0.5 ¹⁾	<0.5 ¹⁾	0.6	0.8	1.2	1.7	2.8	3.8	8.7	10.0 ²⁾	10.0 ²⁾	10.0 ²⁾
6	<0.5 ¹⁾	<0.5 ¹⁾	0.5	0.8	1.2	1.5	2.5	3.3	5.7	10.0 ²⁾	10.0 ²⁾	10.0 ²⁾
8	<0.5 ¹⁾	<0.5 ¹⁾	0.5	0.8	1.1	1.5	2.3	2.9	4.9	10.0 ²⁾	10.0 ²⁾	10.0 ²⁾
10			0.5	0.7	1.0	1.4	2.0	2.5	3.8	8.0	10.0 ²⁾	10.0 ²⁾
13					1.0	1.3	1.9	2.4	3.6	7.0	10.0 ²⁾	10.0 ²⁾
16						1.0	1.3	1.8	2.3	3.3	6.0	8.8
20							1.0	1.2	1.7	2.2	3.2	5.5
25								1.6	2.1	3.0	5.2	7.3
32									2.1	2.9	5.0	7.0
40										2.8	4.8	6.7
50											4.5	6.3
63												5.9

Short circuit selectivity **characteristic D** towards fuse link **NH-00***)

FAZ	NH-00 gL/gG											
I_n [A]	16	20	25	32	35	40	50	63	80	100	125	160
0.5	2.1	10.0 ²⁾	10.0 ²⁾	10.0 ²⁾	10.0 ²⁾	10.0 ²⁾	10.0 ²⁾	10.0 ²⁾	10.0 ²⁾	10.0 ²⁾	10.0 ²⁾	10.0 ²⁾
1.0	<0.5 ¹⁾	0.6	1.4	4.3	10.0 ²⁾	10.0 ²⁾	10.0 ²⁾	10.0 ²⁾	10.0 ²⁾	10.0 ²⁾	10.0 ²⁾	10.0 ²⁾
1.5	<0.5 ¹⁾	<0.5 ¹⁾	0.9	1.6	2.7	4.0	8.0	10.0 ²⁾	10.0 ²⁾	10.0 ²⁾	10.0 ²⁾	10.0 ²⁾
2.0	<0.5 ¹⁾	<0.5 ¹⁾	0.8	1.3	2.1	3.1	6.0	8.6	10.0 ²⁾	10.0 ²⁾	10.0 ²⁾	10.0 ²⁾
2.5	<0.5 ¹⁾	<0.5 ¹⁾	0.7	1.2	1.8	2.6	4.8	6.9	10.0 ²⁾	10.0 ²⁾	10.0 ²⁾	10.0 ²⁾
3.0	<0.5 ¹⁾	<0.5 ¹⁾	0.7	1.1	1.7	2.4	4.3	6.0	10.0 ²⁾	10.0 ²⁾	10.0 ²⁾	10.0 ²⁾
3.5	<0.5 ¹⁾	<0.5 ¹⁾	0.7	1.1	1.7	2.4	4.2	5.6	10.0 ²⁾	10.0 ²⁾	10.0 ²⁾	10.0 ²⁾
4	<0.5 ¹⁾	<0.5 ¹⁾	0.7	1.0	1.6	2.2	3.8	5.2	10.0	10.0 ²⁾	10.0 ²⁾	10.0 ²⁾
5		<0.5 ¹⁾	0.6	0.9	1.4	1.9	3.2	4.1	7.1	10.0 ²⁾	10.0 ²⁾	10.0 ²⁾
6		<0.5 ¹⁾	0.5	0.8	1.2	1.6	2.6	3.3	5.5	10.0 ²⁾	10.0 ²⁾	10.0 ²⁾
8			0.5	0.8	1.1	1.5	2.2	2.7	4.1	8.7	10.0 ²⁾	10.0 ²⁾
10			0.5	0.7	1.0	1.3	1.9	2.5	3.6	7.2	10.0 ²⁾	10.0 ²⁾
13				1.0	1.3	1.9	2.3	3.4	6.5	9.5	10.0 ²⁾	
16					1.1	1.6	2.0	3.0	5.5	8.0	10.0 ²⁾	
20						1.4	1.8	2.8	5.0	7.5	10.0 ²⁾	
25							1.8	2.7	4.8	7.0	10.0 ²⁾	
32								2.4	4.1	6.2	9.3	
40									4.0	6.0	9.0	

¹⁾ Selectivity limit current I_s under 0.5 kA

²⁾ Selectivity limit current I_s = rated breaking capacity I_{cn} of the MCB

Shaded fields: no selectivity

FAZ | Specifications

Short Circuit Selectivity FAZ towards D01-D03 fuse link



In case of short circuit, there is selectivity between the miniature circuit breakers FAZ and the upstream fuses up to the specified values of the selectivity limit current I_s [kA] (i. e. in case of short-circuit currents I_{ks} under I_s , only the MCB will trip, in case of short circuit currents above this value both protective devices will respond).

*) basically in accordance with EN 60898-1 D.5.2.b

Short circuit selectivity **characteristic B** towards fuse link **D01-D03***)

FAZ I_n [A]	D01-D03 gL/gG								
	10	16	20	25	35	50	63	80	100
1.0	<0.5 ¹⁾	10.0 ²⁾	10.0 ²⁾	10.0 ²⁾	10.0 ²⁾	10.0 ²⁾	10.0 ²⁾	10.0 ²⁾	10.0 ²⁾
1.5	<0.5 ¹⁾	4.1	10.0 ²⁾	10.0 ²⁾	10.0 ²⁾	10.0 ²⁾	10.0 ²⁾	10.0 ²⁾	10.0 ²⁾
2.0	<0.5 ¹⁾	<0.5 ¹⁾	0.6	1.0	10.0 ²⁾	10.0 ²⁾	10.0 ²⁾	10.0 ²⁾	10.0 ²⁾
2.5	<0.5 ¹⁾	<0.5 ¹⁾	0.6	1.0	10.0 ²⁾	10.0 ²⁾	10.0 ²⁾	10.0 ²⁾	10.0 ²⁾
3.0	<0.5 ¹⁾	<0.5 ¹⁾	0.5	1.0	10.0 ²⁾	10.0 ²⁾	10.0 ²⁾	10.0 ²⁾	10.0 ²⁾
3.5	<0.5 ¹⁾	<0.5 ¹⁾	0.5	0.9	7.0	10.0 ²⁾	10.0 ²⁾	10.0 ²⁾	10.0 ²⁾
4	<0.5 ¹⁾	<0.5 ¹⁾	0.5	0.9	2.5	10.0 ²⁾	10.0 ²⁾	10.0 ²⁾	10.0 ²⁾
5		<0.5 ¹⁾	0.5	0.8	1.7	4.0	7.0	10.0 ²⁾	10.0 ²⁾
6		<0.5 ¹⁾	0.5	0.8	1.6	3.6	6.0	10.0 ²⁾	10.0 ²⁾
8			0.5	0.8	1.4	2.8	4.3	8.2	10.0 ²⁾
10			0.5	0.7	1.3	2.4	3.4	6.0	10.0 ²⁾
13			<0.5 ¹⁾	0.7	1.2	2.3	3.2	5.3	10.0 ²⁾
16				0.6	1.1	2.2	2.9	4.6	10.0
20					1.1	2.1	2.8	4.4	9.3
25					1.1	2.0	2.7	4.2	8.7
32						2.0	2.6	4.0	8.0
40							2.5	3.8	7.5
50							2.3	3.4	6.7
63									6.2

Short circuit selectivity **characteristic C** towards fuse link **D01-D03***)

FAZ I_n [A]	D01-D03 gL/gG								
	10	16	20	25	35	50	63	80	100
0.75	<0.5 ¹⁾	10.0 ²⁾	10.0 ²⁾	10.0 ²⁾	10.0 ²⁾	10.0 ²⁾	10.0 ²⁾	10.0 ²⁾	10.0 ²⁾
1.0	<0.5 ¹⁾	10.0 ²⁾	10.0 ²⁾	10.0 ²⁾	10.0 ²⁾	10.0 ²⁾	10.0 ²⁾	10.0 ²⁾	10.0 ²⁾
1.5	<0.5 ¹⁾	0.5	0.6	0.9	10.0 ²⁾	10.0 ²⁾	10.0 ²⁾	10.0 ²⁾	10.0 ²⁾
2.0	<0.5 ¹⁾	<0.5 ¹⁾	0.5	0.7	10.0 ²⁾	10.0 ²⁾	10.0 ²⁾	10.0 ²⁾	10.0 ²⁾
2.5	<0.5 ¹⁾	<0.5 ¹⁾	0.5	0.7	10.0 ²⁾	10.0 ²⁾	10.0 ²⁾	10.0 ²⁾	10.0 ²⁾
3.0	<0.5 ¹⁾	<0.5 ¹⁾	<0.5 ¹⁾	0.6	1.9	5.2	10.0 ²⁾	10.0 ²⁾	10.0 ²⁾
3.5	<0.5 ¹⁾	<0.5 ¹⁾	<0.5 ¹⁾	0.6	1.8	4.7	9.5	10.0 ²⁾	10.0 ²⁾
4	<0.5 ¹⁾	<0.5 ¹⁾	<0.5 ¹⁾	0.6	1.6	4.0	7.6	10.0 ²⁾	10.0 ²⁾
5		<0.5 ¹⁾	<0.5 ¹⁾	0.5	1.3	3.1	5.7	10.0 ²⁾	10.0 ²⁾
6		<0.5 ¹⁾	<0.5 ¹⁾	<0.5 ¹⁾	1.2	2.7	4.5	10.0 ²⁾	10.0 ²⁾
8		<0.5 ¹⁾	<0.5 ¹⁾	<0.5 ¹⁾	1.2	2.5	4.0	8.6	10.0 ²⁾
10			<0.5 ¹⁾	<0.5 ¹⁾	1.2	2.3	3.1	5.4	10.0 ²⁾
13					1.1	2.2	3.0	4.9	10.0 ²⁾
16					1.1	2.1	2.8	4.4	9.5
20					1.0	2.0	2.6	4.0	8.3
25						1.9	2.5	3.8	7.8
32							2.5	3.7	7.3
40								3.5	7.0
50									6.5
63									

Short circuit selectivity **characteristic D** towards fuse link **D01-D03***)

FAZ I_n [A]	D01-D03 gL/gG								
	10	16	20	25	35	50	63	80	100
0.5	<0.5 ¹⁾	10.0 ²⁾	10.0 ²⁾	10.0 ²⁾	10.0 ²⁾	10.0 ²⁾	10.0 ²⁾	10.0 ²⁾	10.0 ²⁾
1.0	<0.5 ¹⁾	<0.5 ¹⁾	0.7	1.3	10.0 ²⁾	10.0 ²⁾	10.0 ²⁾	10.0 ²⁾	10.0 ²⁾
1.5	<0.5 ¹⁾	<0.5 ¹⁾	0.6	0.9	2.8	9.0	10.0 ²⁾	10.0 ²⁾	10.0 ²⁾
2.0	<0.5 ¹⁾	<0.5 ¹⁾	0.6	0.8	2.2	6.7	10.0 ²⁾	10.0 ²⁾	10.0 ²⁾
2.5	<0.5 ¹⁾	<0.5 ¹⁾	0.5	0.7	1.9	5.4	10.0 ²⁾	10.0 ²⁾	10.0 ²⁾
3.0	<0.5 ¹⁾	<0.5 ¹⁾	0.5	0.7	1.8	4.8	9.3	10.0 ²⁾	10.0 ²⁾
3.5	<0.5 ¹⁾	<0.5 ¹⁾	0.5	0.7	1.7	4.7	8.6	10.0 ²⁾	10.0 ²⁾
4		<0.5 ¹⁾	0.5	0.7	1.7	4.6	7.7	10.0 ²⁾	10.0 ²⁾
5		<0.5 ¹⁾	<0.5 ¹⁾	0.6	1.5	3.5	5.8	10.0 ²⁾	10.0 ²⁾
6			<0.5 ¹⁾	0.5	1.3	2.9	4.5	9.0	10.0 ²⁾
8			<0.5 ¹⁾	0.5	1.2	2.4	3.5	6.0	10.0 ²⁾
10				0.5	1.1	2.2	3.0	5.0	10.0 ²⁾
13					1.1	2.1	2.9	4.6	10.0 ²⁾
16						1.9	2.6	3.9	9.0
20						1.7	2.3	3.5	8.0
25							2.2	3.4	7.5
32								2.9	6.0
40									5.7

¹⁾ Selectivity limit current I_s under 0.5 kA

²⁾ Selectivity limit current I_s = rated breaking capacity I_{cn} of the MCB

Shaded fields: no selectivity

FAZ | Specifications

Short Circuit Selectivity FAZ towards DII-DIV fuse link



In case of short circuit, there is selectivity between the miniature circuit breakers FAZ and the upstream fuses up to the specified values of the selectivity limit current I_s [kA] (i. e. in case of short-circuit currents I_{ks} under I_s , only the MCB will trip, in case of short circuit currents above this value both protective devices will respond).

*) basically in accordance with EN 60898-1 D.5.2.b

FAZ I_n [A]	DII-DIV gL/gG									
	10	16	20	25	35	50	63	80	100	
1.0	<0.5 ¹⁾	1.2	10.0 ²⁾	10.0 ²⁾	10.0 ²⁾	10.0 ²⁾	10.0 ²⁾	10.0 ²⁾	10.0 ²⁾	10.0 ²⁾
1.5	<0.5 ¹⁾	1.0	10.0 ²⁾	10.0 ²⁾	10.0 ²⁾	10.0 ²⁾	10.0 ²⁾	10.0 ²⁾	10.0 ²⁾	10.0 ²⁾
2.0	<0.5 ¹⁾	<0.5 ¹⁾	0.8	1.6	10.0 ²⁾	10.0 ²⁾	10.0 ²⁾	10.0 ²⁾	10.0 ²⁾	10.0 ²⁾
2.5	<0.5 ¹⁾	<0.5 ¹⁾	0.8	1.5	10.0 ²⁾	10.0 ²⁾	10.0 ²⁾	10.0 ²⁾	10.0 ²⁾	10.0 ²⁾
3.0	<0.5 ¹⁾	<0.5 ¹⁾	0.8	1.4	10.0 ²⁾	10.0 ²⁾	10.0 ²⁾	10.0 ²⁾	10.0 ²⁾	10.0 ²⁾
3.5	<0.5 ¹⁾	<0.5 ¹⁾	0.7	1.3	10.0 ²⁾	10.0 ²⁾	10.0 ²⁾	10.0 ²⁾	10.0 ²⁾	10.0 ²⁾
4	<0.5 ¹⁾	<0.5 ¹⁾	0.6	1.0	3.6	10.0 ²⁾	10.0 ²⁾	10.0 ²⁾	10.0 ²⁾	10.0 ²⁾
5	<0.5 ¹⁾	<0.5 ¹⁾	0.6	0.9	2.0	3.5	8.5	10.0 ²⁾	10.0 ²⁾	10.0 ²⁾
6		<0.5 ¹⁾	0.6	0.9	1.8	3.2	7.4	10.0 ²⁾	10.0 ²⁾	10.0 ²⁾
8		<0.5 ¹⁾	0.5	0.8	1.6	2.6	5.2	8.3	10.0 ²⁾	10.0 ²⁾
10			0.5	0.8	1.4	2.2	3.9	6.0	10.0 ²⁾	10.0 ²⁾
13			0.5	0.7	1.3	2.0	3.6	5.4	10.0 ²⁾	10.0 ²⁾
16				0.6	1.2	1.9	3.2	4.6	8.4	8.4
20					1.2	1.8	3.1	4.4	7.8	7.8
25					1.2	1.8	3.0	4.2	7.3	7.3
32						1.7	2.8	3.9	6.8	6.8
40							2.7	3.8	6.5	6.5
50							2.5	3.5	5.7	5.7
63									5.3	5.3

FAZ I_n [A]	DII-DIV gL/gG									
	10	16	20	25	35	50	63	80	100	
0.75	1.0	10.0 ²⁾	10.0 ²⁾	10.0 ²⁾	10.0 ²⁾	10.0 ²⁾	10.0 ²⁾	10.0 ²⁾	10.0 ²⁾	10.0 ²⁾
1.0	<0.5 ¹⁾	1.2	10.0 ²⁾	10.0 ²⁾	10.0 ²⁾	10.0 ²⁾	10.0 ²⁾	10.0 ²⁾	10.0 ²⁾	10.0 ²⁾
1.5	<0.5 ¹⁾	<0.5 ¹⁾	1.0	2.2	10.0 ²⁾	10.0 ²⁾	10.0 ²⁾	10.0 ²⁾	10.0 ²⁾	10.0 ²⁾
2.0	<0.5 ¹⁾	<0.5 ¹⁾	0.8	1.6	10.0 ²⁾	10.0 ²⁾	10.0 ²⁾	10.0 ²⁾	10.0 ²⁾	10.0 ²⁾
2.5	<0.5 ¹⁾	<0.5 ¹⁾	0.8	1.4	10.0 ²⁾	10.0 ²⁾	10.0 ²⁾	10.0 ²⁾	10.0 ²⁾	10.0 ²⁾
3.0	<0.5 ¹⁾	<0.5 ¹⁾	0.8	0.9	10.0 ²⁾	10.0 ²⁾	10.0 ²⁾	10.0 ²⁾	10.0 ²⁾	10.0 ²⁾
3.5	<0.5 ¹⁾	<0.5 ¹⁾	0.6	0.9	2.2	4.5	10.0 ²⁾	10.0 ²⁾	10.0 ²⁾	10.0 ²⁾
4	<0.5 ¹⁾	<0.5 ¹⁾	0.6	0.8	1.8	3.6	9.7	10.0 ²⁾	10.0 ²⁾	10.0 ²⁾
5	<0.5 ¹⁾	<0.5 ¹⁾	0.6	0.7	1.5	2.7	7.3	10.0 ²⁾	10.0 ²⁾	10.0 ²⁾
6		<0.5 ¹⁾	0.5	0.6	1.4	2.4	5.5	10.0 ²⁾	10.0 ²⁾	10.0 ²⁾
8		<0.5 ¹⁾	<0.5 ¹⁾	0.6	1.3	2.2	4.7	8.7	10.0 ²⁾	10.0 ²⁾
10			<0.5 ¹⁾	0.6	1.3	2.0	3.6	5.4	10.0 ²⁾	10.0 ²⁾
13					1.3	1.9	3.3	5.0	9.4	9.4
16					1.2	1.8	3.2	4.4	8.0	8.0
20					1.2	1.8	3.1	4.1	7.0	7.0
25						1.7	2.8	3.8	6.5	6.5
32							2.7	3.7	6.2	6.2
40								3.5	5.9	5.9
50									5.5	5.5
63										

Short circuit selectivity **characteristic D** towards fuse link **DII-DIV***)

FAZ I_n [A]	DII-DIV gL/gG									
	10	16	20	25	35	50	63	80	100	
0.5	0.5	3.0	10.0 ²⁾	10.0 ²⁾	10.0 ²⁾	10.0 ²⁾	10.0 ²⁾	10.0 ²⁾	10.0 ²⁾	10.0 ²⁾
1.0	<0.5 ¹⁾	<0.5 ¹⁾	1.0	2.4	10.0 ²⁾	10.0 ²⁾	10.0 ²⁾	10.0 ²⁾	10.0 ²⁾	10.0 ²⁾
1.5	<0.5 ¹⁾	<0.5 ¹⁾	0.7	1.2	3.5	7.7	10.0 ²⁾	10.0 ²⁾	10.0 ²⁾	10.0 ²⁾
2.0	<0.5 ¹⁾	<0.5 ¹⁾	0.6	1.0	2.8	5.8	10.0 ²⁾	10.0 ²⁾	10.0 ²⁾	10.0 ²⁾
2.5	<0.5 ¹⁾	<0.5 ¹⁾	0.6	1.4	2.3	4.6	10.0 ²⁾	10.0 ²⁾	10.0 ²⁾	10.0 ²⁾
3.0	<0.5 ¹⁾	<0.5 ¹⁾	0.6	0.9	2.3	4.3	10.0 ²⁾	10.0 ²⁾	10.0 ²⁾	10.0 ²⁾
3.5	<0.5 ¹⁾	<0.5 ¹⁾	0.6	0.9	2.1	4.0	10.0 ²⁾	10.0 ²⁾	10.0 ²⁾	10.0 ²⁾
4		<0.5 ¹⁾	0.6	0.9	2.0	3.8	9.5	10.0 ²⁾	10.0 ²⁾	10.0 ²⁾
5		<0.5 ¹⁾	0.5	0.7	1.7	3.1	7.0	10.0 ²⁾	10.0 ²⁾	10.0 ²⁾
6			0.5	0.7	1.5	2.6	5.3	9.1	10.0 ²⁾	10.0 ²⁾
8			<0.5 ¹⁾	0.7	1.4	2.2	3.9	6.0	10.0 ²⁾	10.0 ²⁾
10				0.7	1.2	1.9	3.4	5.0	9.5	9.5
13					1.2	1.8	3.2	4.6	8.6	8.6
16						1.6	2.7	4.0	7.4	7.4
20						1.5	2.5	3.5	6.7	6.7
25							2.4	3.4	6.2	6.2
32								2.8	5.0	5.0
40									4.8	4.8

¹⁾ Selectivity limit current I_s under 0.5 kA

²⁾ Selectivity limit current I_s = rated breaking capacity I_{cn} of the MCB

Shaded fields: no selectivity

FAZ | Specifications

Short-Circuit Selectivity

Between FAZ-B and NZM 1/2



Selectivity-limit current I_s [kA] for selectivity between FAZ-B and NZM (overload and short-circuit release unit NZM at max. value).

I_n [A]	NZM...1-A...						NZM...2-A...								
	$I_{cu} = 25 (50) \text{ kA}$						$I_{cu} = 25 (50)(100)(150) \text{ kA}$								
FAZ-B	40	50	63	80	100	125	40	50	63	80	100	125	160	200	250
1	15	15	15	15	15	15	15	15	15	15	15	15	15	15	15
2	2	15	15	15	15	15	3	15	15	15	15	15	15	15	15
3	1.2	2	3	3	10	15	1.5	1.5	3	5	15	15	15	15	15
4	1.2	2	3	3	8	15	1.2	1.5	3	4	15	15	15	15	15
6	1.2	2	2.5	3	5	10	1.2	1.5	2.5	3	15	15	15	15	15
10	1.2	1.5	2	2	4	10	1	1.5	2.5	3	10	10	10	10	10
13	1	1.5	2	2	4	10	1	1.2	2	3	10	10	10	10	10
16	1	1.2	1.5	2	3	8	1	1.2	1.5	2.5	10	10	10	10	10
20	0.8	1.2	1.5	1.5	3	8	1	1.2	1.5	1.5	10	10	10	10	10
25	0.7	1.2	1.5	1.5	3	7	0.8	1	1.5	2	10	10	10	10	10
32	-	1.2	1	1.5	2	6	-	1	1.5	2	8	8	8	8	10
40	-	-	1	1.5	2	5	-	-	1.2	1.5	7	7	7	7	10
50	-	-	-	1.2	1.5	4	-	-	-	1.5	6	6	6	6	10
63	-	-	-	-	1.5	3	-	-	-	-	6	6	6	6	10

Between FAZ-C and NZM 1/2

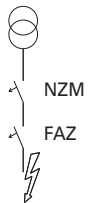

Selectivity-limit current I_s [kA] for selectivity between FAZ-C and NZM (overload and short-circuit release unit NZM at max. value).

I_n [A]	NZM...1-A...						NZM...2-A...								
	$I_{cu} = 25 (50) \text{ kA}$						$I_{cu} = 25 (50)(100)(150) \text{ kA}$								
FAZ-C	40	50	63	80	100	125	40	50	63	80	100	125	160	200	250
0.5	15	15	15	15	15	15	15	15	15	15	15	15	15	15	15
1	15	15	15	15	15	15	15	15	15	15	15	15	15	15	15
2	2	15	15	15	15	15	3	15	15	15	15	15	15	15	15
3	1.2	2	3	3	10	15	1.5	1.5	3	5	15	15	15	15	15
4	1.2	2	3	3	8	15	1.2	1.5	3	4	15	15	15	15	15
6	1.2	2	2.5	3	5	10	1.2	1.5	2.5	3	15	15	15	15	15
10	1.2	1.5	2	2	4	10	1	1.5	2.5	3	10	10	10	10	10
13	1	1.5	2	2	4	10	1	1.2	2	3	10	10	10	10	10
16	1	1.2	1.5	2	3	8	1	1.2	1.5	2.5	10	10	10	10	10
20	0.8	1.2	1.5	1.5	3	8	1	1.2	1.5	1.5	10	10	10	10	10
25	0.7	1.2	1.5	1.5	3	7	0.8	1	1.5	2	10	10	10	10	10
32	-	1.2	1	1.5	2	6	-	1	1.5	2	8	8	8	8	10
40	-	-	1	1.5	2	5	-	-	1.2	1.5	7	7	7	7	10
50	-	-	-	1.2	1.5	4	-	-	-	1.5	6	6	6	6	10
63	-	-	-	-	1.5	3	-	-	-	-	6	6	6	6	10

FAZ | Specifications

Short-Circuit Selectivity

Between FAZ-D and NZM 1/2

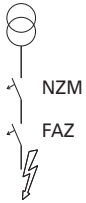

Selectivity-limit current I_g [kA] for selectivity between FAZ-D and NZM (overload and short-circuit release unit NZM at max. value).

I_n [A]	NZM...1-A...						NZM...2-A...								
	$I_{cu} = 25 (50) \text{ kA}$						$I_{cu} = 25 (50)(100)(150) \text{ kA}$								
FAZ-D	40	50	63	80	100	125	40	50	63	80	100	125	160	200	250
0.5	9	15	15	15	15	15	9	15	15	15	15	15	15	15	15
1	0.5	0.7	1.1	1.9	4.2	15	0.5	0.7	1.1	1.9	4.2	15	15	15	15
1.5	0.3	0.6	0.8	1.1	1.6	2.6	0.3	0.6	0.8	1.1	1.6	2.6	5	15	15
2	0.3	0.5	0.75	0.95	1.4	2.4	0.3	0.5	0.75	0.95	1.4	2.4	4.5	10	15
2.5	0.3	0.5	0.75	0.95	1.3	2.3	0.3	0.5	0.75	0.95	1.3	2.3	4.2	9	15
3	0.3	0.5	0.7	0.9	1.3	2.1	0.3	0.5	0.7	0.9	1.3	2.1	3.6	7	15
3.5	0.3	0.5	0.7	0.9	1.3	2	0.3	0.5	0.7	0.9	1.3	2	3.3	5.6	10
4	0.3	0.5	0.7	0.9	1.3	1.9	0.3	0.5	0.7	0.9	1.3	1.9	3	4.7	8
5	0.3	0.5	0.7	0.9	1.3	1.9	0.3	0.5	0.7	0.9	1.3	1.9	3	4.4	7
6	0.3	0.5	0.6	0.9	1.3	1.8	0.3	0.5	0.6	0.9	1.3	1.8	2.8	4	6
8	0.3	0.3	0.6	0.75	1	1.3	0.3	0.3	0.6	0.75	1	1.3	1.8	2.7	4
10	0.3	0.3	0.6	0.75	0.95	1.2	0.3	0.3	0.6	0.75	0.95	1.2	1.7	2.4	3.6
13	0.3	0.3	0.5	0.7	0.9	1.1	0.3	0.3	0.5	0.7	0.9	1.1	1.6	2.2	3.2
16	-	0.3	0.5	0.65	0.8	1.1	-	0.3	0.5	0.65	0.8	1.1	1.5	2.1	3
20	-	-	0.5	0.65	0.8	1.1	-	-	0.5	0.65	0.8	1.1	1.4	2.1	3
25	-	-	0.5	0.65	0.8	1.1	-	-	0.5	0.65	0.8	1.1	1.4	1.9	2.7
32	-	-	-	-	0.8	1.1	-	-	-	-	0.8	1.1	1.4	1.9	2.7
40	-	-	-	-	-	1	-	-	-	-	-	1	1.4	1.8	2.6

FAZ | Specifications

Back-up Protection

FAZ/C through PLHT/C

Upstream PLHT protects downstream FAZ up to the specified prospective short-circuit current. Test acc. to IEC 60947.2 -A.6

I_n [A]	PLHT/C								
	I_n [A]								
FAZ/C	20	25	32	40	50	63	80	100	125
1	25	25	25	25	25	25	20	20	15 kA
2	25	25	25	25	25	25	20	20	15 kA
4	25	25	25	25	25	25	20	20	15 kA
6	25	25	25	25	25	25	20	20	15 kA
10	25	25	25	25	25	25	20	20	15 kA
13	25	25	25	25	25	25	20	20	15 kA
16	25	25	25	25	25	25	20	20	15 kA
20	1)	25	25	25	25	25	20	20	15 kA
25	1)	1)	25	25	25	25	20	20	15 kA
32	1)	1)	1)	25	25	25	20	20	-
40	1)	1)	1)	1)	25	25	20	20	-
50	1)	1)	1)	1)	1)	25	20	20	-
63	1)	1)	1)	1)	1)	1)	-	-	-

1) I_n (PLHT) \leq I_n (FAZ)

FAZ / CL-PKZ0

Back-up tests acc. to EN/IEC 60947-2, App. A: $U = 1.05 U_e$, (O - t - CO)

I_n [A]	FAZ- $I_{\Delta n}$ /1(2,3,4)/B(C) + CL-PKZ0 $U_e = 230/400$ V
0.16	65 kA
0.25	65 kA
0.5	65 kA
0.75	65 kA
1	65 kA
1.5	65 kA
2	65 kA
2.5	65 kA
3	65 kA
3.5	65 kA
4	65 kA
5	45 kA
6	45 kA
8	45 kA
10	45 kA
12	45 kA
13	45 kA
15	45 kA
16	45 kA
20	45 kA
25	45 kA
32	45 kA
40	25 kA
50	25 kA
63	25 kA

FAZ / NZM7

I_n [A]	FAZ- $I_{\Delta n}$ /1(2,3,4)/B(C) + NZM7-40(...100) $U_e = 230/400$ V
0.16	25 kA
0.25	25 kA
0.5	25 kA
0.75	25 kA
1	25 kA
1.5	25 kA
2	25 kA
2.5	25 kA
3	25 kA
3.5	25 kA
4	25 kA
5	20 kA
6	20 kA
8	20 kA
10	20 kA
12	20 kA
13	20 kA
15	20 kA
16	20 kA
20	18 kA
25	18 kA
32	18 kA
40	18 kA
50	15 kA
63	15 kA

FAZ | Specifications

Back-up Protection

FAZ / NZMB1

$U_e = 230/400 \text{ V}$: I_{cu} (FAZ) = 15 kA
 $U_e = 230/400 \text{ V}$: I_{cu} (NZMB1) = 25 kA
 Back-up test acc. EN/IEC 60947-2, app. A: $U = 1.05U_e$, (O - t - CO)
 (Settings NZMB1: I_r , I_{rm} at max. volumes)

I_n [A]	FAZ-$I_n/1(2,3,4)/B(C)$ + NZMB1 $U_e = 230/400 \text{ V}$
0.16	25 kA
0.25	25 kA
0.5	25 kA
0.75	25 kA
1	25 kA
1.5	25 kA
2	25 kA
2.5	25 kA
3	25 kA
3.5	25 kA
4	25 kA
5	25 kA
6	25 kA
8	25 kA
10	25 kA
12	25 kA
13	25 kA
15	25 kA
16	25 kA
20	20 kA
25	20 kA
32	20 kA
40	20 kA
50	15 kA
63	15 kA

FAZ / NZMN1

$U_e = 230/400 \text{ V}$: I_{cu} (FAZ) = 15 kA
 $U_e = 230/400 \text{ V}$: I_{cu} (NZMN1) = 25 kA
 Back-up test acc. EN/IEC 60947-2, app. A: $U = 1.05U_e$, (O - t - CO)
 (Settings NZM at max. values)

I_n [A]	FAZ-$I_n/1(2,3,4)/B(C)$ + NZMN1 $U_e = 230/400 \text{ V}$
0.16	25 kA
0.25	25 kA
0.5	25 kA
0.75	25 kA
1	25 kA
1.5	25 kA
2	25 kA
2.5	25 kA
3	25 kA
3.5	25 kA
4	25 kA
5	25 kA
6	25 kA
8	25 kA
10	25 kA
12	25 kA
13	25 kA
15	25 kA
16	25 kA
20	20 kA
25	20 kA
32	20 kA
40	20 kA
50	15 kA
63	15 kA

FAZ | Specifications

Back-up Protection

FAZ / NZMB2

$U_e = 230/400 \text{ V}$: I_{cu} (FAZ) = 15 kA
 $U_e = 230/400 \text{ V}$: I_{cu} (NZMB2) = 25 kA
 $U_e = 133/230 \text{ V}$: I_{cu} (FAZ) = 20 kA
 $U_e = 133/230 \text{ V}$: I_{cu} (NZMB2) = 30 kA
 Back-up test acc. EN/IEC 60947-2, app. A: $U = 1.05U_e$, (O - t - CO)
 (Settings NZM at max. values)

I_n [A]	FAZ- $I_n/1(2,3,4)/B(C)$ + NZMB2	
	$U_e = 230/400 \text{ V}$	$U_e = 133/230 \text{ V}$
0.16	25 kA	30 kA
0.25	25 kA	30 kA
0.5	25 kA	30 kA
0.75	25 kA	30 kA
1	25 kA	30 kA
1.5	25 kA	30 kA
2	25 kA	30 kA
2.5	25 kA	30 kA
3	25 kA	30 kA
3.5	25 kA	30 kA
4	25 kA	30 kA
5	25 kA	25 kA
6	25 kA	25 kA
8	25 kA	25 kA
10	25 kA	25 kA
12	20 kA	25 kA
13	20 kA	25 kA
15	20 kA	25 kA
16	20 kA	25 kA
20	20 kA	25 kA
25	20 kA	25 kA
32	20 kA	25 kA
40	15 kA	20 kA
50	15 kA	20 kA
63	15 kA	20 kA

FAZ / NZMN2

$U_e = 230/400 \text{ V}$: I_{cu} (FAZ) = 15 kA
 $U_e = 230/400 \text{ V}$: I_{cu} (NZMN2) = 50 kA
 $U_e = 133/230 \text{ V}$: I_{cu} (FAZ) = 20 kA
 $U_e = 133/230 \text{ V}$: I_{cu} (NZMN2) = 85 kA
 Back-up test acc. EN/IEC 60947-2, app. A: $U = 1.05U_e$, (O - t - CO)
 (Settings NZM at max. values)

I_n [A]	FAZ- $I_n/1(2,3,4)/B(C)$ + NZMN2	
	$U_e = 230/400 \text{ V}$	$U_e = 133/230 \text{ V}$
0.16	50 kA	85 kA
0.25	50 kA	85 kA
0.5	50 kA	85 kA
0.75	50 kA	85 kA
1	50 kA	85 kA
1.5	50 kA	85 kA
2	50 kA	85 kA
2.5	50 kA	85 kA
3	50 kA	85 kA
3.5	50 kA	85 kA
4	50 kA	85 kA
5	50 kA	80 kA
6	50 kA	80 kA
8	50 kA	80 kA
10	50 kA	80 kA
12	30 kA	60 kA
13	30 kA	60 kA
15	30 kA	60 kA
16	30 kA	60 kA
20	30 kA	60 kA
25	30 kA	60 kA
32	30 kA	60 kA
40	20 kA	40 kA
50	20 kA	40 kA
63	20 kA	40 kA

FAZ | Specifications

Back-up Protection

FAZ / NZMH2

$U_e = 230/400\text{ V}$: I_{cu} (FAZ) = 15 kA
 $U_e = 230/400\text{ V}$: I_{cu} (NZMH2) = 150 kA
 $U_e = 133/230\text{ V}$: I_{cu} (FAZ) = 20 kA
 $U_e = 133/230\text{ V}$: I_{cu} (NZMH2) = 150 kA
 Back-up test acc. EN/IEC 60947-2, app. A: $U = 1.05U_e$, (O - t - CO)
 (Settings NZM at max. values)

I_n [A]	FAZ- $I_n/1(2,3,4)/B(C)$ + NZMH2	
	$U_e = 230/400\text{ V}$	$U_e = 133/230\text{ V}$
0.16	50 kA	85 kA
0.25	50 kA	85 kA
0.5	50 kA	85 kA
0.75	50 kA	85 kA
1	50 kA	85 kA
1.5	50 kA	85 kA
2	50 kA	85 kA
2.5	50 kA	85 kA
3	50 kA	85 kA
3.5	50 kA	85 kA
4	50 kA	85 kA
5	50 kA	80 kA
6	50 kA	80 kA
8	50 kA	80 kA
10	50 kA	80 kA
12	30 kA	60 kA
13	30 kA	60 kA
15	30 kA	60 kA
16	30 kA	60 kA
20	30 kA	60 kA
25	30 kA	60 kA
32	30 kA	60 kA
40	20 kA	40 kA
50	20 kA	40 kA
63	20 kA	40 kA

FAZ / NZML2

$U_e = 230/400\text{ V}$: I_{cu} (FAZ) = 15 kA
 $U_e = 230/400\text{ V}$: I_{cu} (NZML2) = 150 kA
 $U_e = 133/230\text{ V}$: I_{cu} (FAZ) = 20 kA
 $U_e = 133/230\text{ V}$: I_{cu} (NZML2) = 150 kA
 Back-up test acc. EN/IEC 60947-2, app. A: $U = 1.05U_e$, (O - t - CO)
 (Settings NZM at max. values)

I_n [A]	FAZ- $I_n/1(2,3,4)/B(C)$ + NZML2	
	$U_e = 230/400\text{ V}$	$U_e = 133/230\text{ V}$
0.16	50 kA	85 kA
0.25	50 kA	85 kA
0.5	50 kA	85 kA
0.75	50 kA	85 kA
1	50 kA	85 kA
1.5	50 kA	85 kA
2	50 kA	85 kA
2.5	50 kA	85 kA
3	50 kA	85 kA
3.5	50 kA	85 kA
4	50 kA	85 kA
5	50 kA	80 kA
6	50 kA	80 kA
8	50 kA	80 kA
10	50 kA	80 kA
12	30 kA	60 kA
13	30 kA	60 kA
15	30 kA	60 kA
16	30 kA	60 kA
20	30 kA	60 kA
25	30 kA	60 kA
32	30 kA	60 kA
40	20 kA	40 kA
50	20 kA	40 kA
63	20 kA	40 kA

FAZ | Specifications

Back-up Protection

FAZ / NH

$U_e = 230\text{ V}$: I_{cu} (FAZ) = 15 (10) kA (acc. to IEC/EN 60947)

$U_e = 500\text{ V}$: I_{cu} (NH00 125 A gL / gG) = 120kA

I_n [A]	FAZ-I_n/B,(C),(D)... + NH00 125 A gL/gG IT-system U = 230 V
0,5	50 kA
1	50 kA
2	50 kA
3	50 kA
4	50 kA
6	50 kA
10	50 kA
13	50 kA
16	50 kA
20	50 kA
25	50 kA
32	50 kA
40	50 kA
50	50 kA
63	50 kA

FAZ | Specifications

Overload Selectivity

FAZ-B(C)(D) to FAZ-B

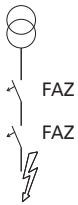

Upstream side FAZ, Characteristic B
Downstream side FAZ, Characteristic B, C, D

x ... Selectivity range (i.e. only the downstream switch drops in case $I < I_s$)

Upstream side →		FAZ Characteristic B												
Type B rated current I_n [A]		2	3	4	6	10	13	16	20	25	32	40	50	63
Selectivity limiting current I_s [A]		7	10.5	14	21	35	45.5	56	70	87.5	112	140	175	220.5
Downstream side FAZ Characteristic B	2		x	x	x	x	x	x	x	x	x	x	x	x
	3			x	x	x	x	x	x	x	x	x	x	x
	4				x	x	x	x	x	x	x	x	x	x
	6					x	x	x	x	x	x	x	x	x
	10						x	x	x	x	x	x	x	x
	13							x	x	x	x	x	x	x
	16								x	x	x	x	x	x
	20									x	x	x	x	x
	25										x	x	x	x
	32											x	x	x
	40												x	x
	50													x
	63													

Upstream side →		FAZ Characteristic B												
Type B rated current I_n [A]		2	3	4	6	10	13	16	20	25	32	40	50	63
Selectivity limiting current I_s [A]		7	10.5	14	21	35	45.5	56	70	87.5	112	140	175	220.5
Downstream side FAZ Characteristic C	0.5	x	x	x	x	x	x	x	x	x	x	x	x	x
	1	x	x	x	x	x	x	x	x	x	x	x	x	x
	2			x	x	x	x	x	x	x	x	x	x	x
	3				x	x	x	x	x	x	x	x	x	x
	4					x	x	x	x	x	x	x	x	x
	6						x	x	x	x	x	x	x	x
	8							x	x	x	x	x	x	x
	10								x	x	x	x	x	x
	13									x	x	x	x	x
	16										x	x	x	x
	20											x	x	x
	25												x	x
	32													x
	40													
50														
63														

Upstream side →		FAZ Characteristic B												
Type B rated current I_n [A]		2	3	4	6	10	13	16	20	25	32	40	50	63
Selectivity limiting current I_s [A]		7	10.5	14	21	35	45.5	56	70	87.5	112	140	175	220.5
Downstream side FAZ Characteristic D	2					x	x	x	x	x	x	x	x	x
	4							x	x	x	x	x	x	x
	6								x	x	x	x	x	x
	10										x	x	x	x
	13											x	x	x
	16												x	x
	20													x
	25													
	32													
	40													

FAZ | Specifications

Overload Selectivity

FAZ-B(C)(D) to FAZ-C

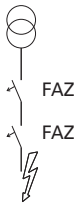

Upstream side FAZ, Characteristic C
Downstream side FAZ, Characteristic B, C, D

x ... Selectivity range (i.e. only the downstream switch drops in case $I < I_s$)

Upstream side →		FAZ Characteristic C																
Type B rated current I_n [A]		0.5	1	2	3	4	6	8	10	13	16	20	25	32	40	50	63	
Selectivity limiting current I_s [A]		2.85	5.7	11.4	17.1	22.8	34.2	45.6	57	74.1	91.2	114	142.5	182.4	228	285	359.1	
Downstream side FAZ Characteristic B	2				x	x	x	x	x	x	x	x	x	x	x	x	x	
	3					x	x	x	x	x	x	x	x	x	x	x	x	
	4						x	x	x	x	x	x	x	x	x	x	x	
	6							x	x	x	x	x	x	x	x	x	x	
	10									x	x	x	x	x	x	x	x	
	13											x	x	x	x	x	x	
	16												x	x	x	x	x	
	20													x	x	x	x	
	25														x	x	x	x
	32															x	x	x
	40																x	x
	50																	x
	63																	

Upstream side →		FAZ Characteristic C															
Type B rated current I_n [A]		0.5	1	2	3	4	6	8	10	13	16	20	25	32	40	50	63
Selectivity limiting current I_s [A]		2.85	5.7	11.4	17.1	22.8	34.2	45.6	57	74.1	91.2	114	142.5	182.4	228	285	359.1
Downstream side FAZ Characteristic C	0.5		x	x	x	x	x	x	x	x	x	x	x	x	x	x	x
	1			x	x	x	x	x	x	x	x	x	x	x	x	x	x
	2				x	x	x	x	x	x	x	x	x	x	x	x	x
	3					x	x	x	x	x	x	x	x	x	x	x	x
	4						x	x	x	x	x	x	x	x	x	x	x
	6							x	x	x	x	x	x	x	x	x	x
	8								x	x	x	x	x	x	x	x	x
	10									x	x	x	x	x	x	x	x
	13										x	x	x	x	x	x	x
	16											x	x	x	x	x	x
	20												x	x	x	x	x
	25													x	x	x	x
	32														x	x	x
	40															x	x
50																x	
63																	x

Upstream side →		FAZ Characteristic C																
Type B rated current I_n [A]		0.5	1	2	3	4	6	8	10	13	16	20	25	32	40	50	63	
Selectivity limiting current I_s [A]		2.85	5.7	11.4	17.1	22.8	34.2	45.6	57	74.1	91.2	114	142.5	182.4	228	285	359.1	
Downstream side FAZ Characteristic D	2						x	x	x	x	x	x	x	x	x	x	x	
	4							x	x	x	x	x	x	x	x	x	x	
	6								x	x	x	x	x	x	x	x	x	
	10										x	x	x	x	x	x	x	
	13												x	x	x	x	x	
	16													x	x	x	x	
	20														x	x	x	
	25															x	x	
	32																	
	40																	

FAZ | Specifications

Overload Selectivity

FAZ-B(C)(D) to FAZ-D

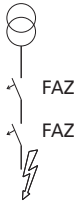

Upstream side FAZ, Characteristic D
Downstream side FAZ, Characteristic B, C, D

x ... Selectivity range (i.e. only the downstream switch drops in case $I < I_s$)

Upstream side →		FAZ Characteristic D									
Type B rated current I_n [A]		2	4	6	10	13	16	20	25	32	40
Selectivity limiting current I_s [A]		21	42	63	105	136.5	168	210	262.5	336	420
Downstream side FAZ Characteristic B	2		x	x	x	x	x	x	x	x	x
	3		x	x	x	x	x	x	x	x	x
	4			x	x	x	x	x	x	x	x
	6				x	x	x	x	x	x	x
	10					x	x	x	x	x	x
	13						x	x	x	x	x
	16							x	x	x	x
	20								x	x	x
	25									x	x
	32										x
	40										
	50										
	63										

Upstream side →		FAZ Characteristic D									
Type B rated current I_n [A]		2	4	6	10	13	16	20	25	32	40
Selectivity limiting current I_s [A]		21	42	63	105	136.5	168	210	262.5	336	420
Downstream side FAZ Characteristic C	0.5	x	x	x	x	x	x	x	x	x	x
	1	x	x	x	x	x	x	x	x	x	x
	2		x	x	x	x	x	x	x	x	x
	3		x	x	x	x	x	x	x	x	x
	4			x	x	x	x	x	x	x	x
	6				x	x	x	x	x	x	x
	8				x	x	x	x	x	x	x
	10					x	x	x	x	x	x
	13						x	x	x	x	x
	16							x	x	x	x
	20								x	x	x
	25									x	x
	32										x
	40										
	50										
63											

Upstream side →		FAZ Characteristic D									
Type B rated current I_n [A]		2	4	6	10	13	16	20	25	32	40
Selectivity limiting current I_s [A]		21	42	63	105	136.5	168	210	262.5	336	420
Downstream side FAZ Characteristic D	2		x	x	x	x	x	x	x	x	x
	4			x	x	x	x	x	x	x	x
	6				x	x	x	x	x	x	x
	10					x	x	x	x	x	x
	13						x	x	x	x	x
	16							x	x	x	x
	20								x	x	x
	25									x	x
	32										x
	40										

FAZ | Specifications

Overload Selectivity

FAZ-B(C)(D) to PLHT-B

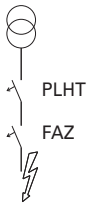

Upstream side PLHT, Characteristic B
Downstream side FAZ, Characteristic B, C, D

x ... Selectivity range (i.e. only the downstream switch drops in case $I < I_s$)

Upstream side →		PLHT Characteristic B									
Type B rated current I_n [A]		20	25	32	40	50	63	80	100	125	
Selectivity limiting current I_s [A]		65	81	104	130	163	205	260	325	406	
Downstream side FAZ Characteristic B	2	x	x	x	x	x	x	x	x	x	x
	3	x	x	x	x	x	x	x	x	x	x
	4	x	x	x	x	x	x	x	x	x	x
	6	x	x	x	x	x	x	x	x	x	x
	10	x	x	x	x	x	x	x	x	x	x
	13	x	x	x	x	x	x	x	x	x	x
	16	x	x	x	x	x	x	x	x	x	x
	20		x	x	x	x	x	x	x	x	x
	25			x	x	x	x	x	x	x	x
	32				x	x	x	x	x	x	x
	40					x	x	x	x	x	x
	50						x	x	x	x	x
	63							x	x	x	x

Upstream side →		PLHT Characteristic B									
Type B rated current I_n [A]		20	25	32	40	50	63	80	100	125	
Selectivity limiting current I_s [A]		65	81	104	130	163	205	260	325	406	
Downstream side FAZ Characteristic C	0.5	x	x	x	x	x	x	x	x	x	x
	1	x	x	x	x	x	x	x	x	x	x
	2	x	x	x	x	x	x	x	x	x	x
	3	x	x	x	x	x	x	x	x	x	x
	4	x	x	x	x	x	x	x	x	x	x
	6	x	x	x	x	x	x	x	x	x	x
	8	x	x	x	x	x	x	x	x	x	x
	10	x	x	x	x	x	x	x	x	x	x
	13		x	x	x	x	x	x	x	x	x
	16			x	x	x	x	x	x	x	x
	20				x	x	x	x	x	x	x
	25					x	x	x	x	x	x
	32						x	x	x	x	x
	40							x	x	x	x
50								x	x	x	
63									x	x	

Upstream side →		PLHT Characteristic B									
Type B rated current I_n [A]		20	25	32	40	50	63	80	100	125	
Selectivity limiting current I_s [A]		65	81	104	130	163	205	260	325	406	
Downstream side FAZ Characteristic D	2	x	x	x	x	x	x	x	x	x	x
	4	x	x	x	x	x	x	x	x	x	x
	6		x	x	x	x	x	x	x	x	x
	10				x	x	x	x	x	x	x
	13					x	x	x	x	x	x
	16						x	x	x	x	x
	20							x	x	x	x
	25								x	x	x
32									x	x	
40										x	

FAZ | Specifications

Overload Selectivity

FAZ-B(C)(D) to PLHT-C

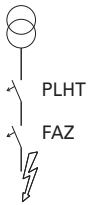

Upstream side PLHT, Characteristic C
Downstream side FAZ, Characteristic B, C, D

x ... Selectivity range (i.e. only the downstream switch drops in case $I < I_s$)

Upstream side →		PLHT Characteristic C									
Type B rated current I_n [A]		20	25	32	40	50	63	80	100	125	
Selectivity limiting current I_s [A]		130	163	208	260	325	410	520	650	813	
Downstream side FAZ Characteristic B	2	x	x	x	x	x	x	x	x	x	x
	3	x	x	x	x	x	x	x	x	x	x
	4	x	x	x	x	x	x	x	x	x	x
	6	x	x	x	x	x	x	x	x	x	x
	10	x	x	x	x	x	x	x	x	x	x
	13	x	x	x	x	x	x	x	x	x	x
	16	x	x	x	x	x	x	x	x	x	x
	20		x	x	x	x	x	x	x	x	x
	25			x	x	x	x	x	x	x	x
	32				x	x	x	x	x	x	x
	40					x	x	x	x	x	x
	50						x	x	x	x	x
	63							x	x	x	x

Upstream side →		PLHT Characteristic C									
Type B rated current I_n [A]		20	25	32	40	50	63	80	100	125	
Selectivity limiting current I_s [A]		130	163	208	260	325	410	520	650	813	
Downstream side FAZ Characteristic C	0.5	x	x	x	x	x	x	x	x	x	x
	1	x	x	x	x	x	x	x	x	x	x
	2	x	x	x	x	x	x	x	x	x	x
	3	x	x	x	x	x	x	x	x	x	x
	4	x	x	x	x	x	x	x	x	x	x
	6	x	x	x	x	x	x	x	x	x	x
	8	x	x	x	x	x	x	x	x	x	x
	10	x	x	x	x	x	x	x	x	x	x
	13	x	x	x	x	x	x	x	x	x	x
	16	x	x	x	x	x	x	x	x	x	x
	20		x	x	x	x	x	x	x	x	x
	25			x	x	x	x	x	x	x	x
	32				x	x	x	x	x	x	x
	40					x	x	x	x	x	x
50						x	x	x	x	x	
63							x	x	x	x	

Upstream side →		PLHT Characteristic C									
Type B rated current I_n [A]		20	25	32	40	50	63	80	100	125	
Selectivity limiting current I_s [A]		130	163	208	260	325	410	520	650	813	
Downstream side FAZ Characteristic D	2	x	x	x	x	x	x	x	x	x	x
	4	x	x	x	x	x	x	x	x	x	x
	6	x	x	x	x	x	x	x	x	x	x
	10	x	x	x	x	x	x	x	x	x	x
	13		x	x	x	x	x	x	x	x	x
	16			x	x	x	x	x	x	x	x
	20				x	x	x	x	x	x	x
	25					x	x	x	x	x	x
32						x	x	x	x	x	
40							x	x	x	x	

FAZ | Specifications

Overload Selectivity

FAZ-B(C)(D) to PLHT-D

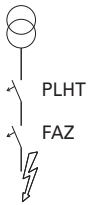

Upstream side PLHT, Characteristic D
Downstream side FAZ, Characteristic B, C, D

x ... Selectivity range (i.e. only the downstream switch drops in case $I < I_s$)

Upstream side →		PLHT Characteristic D							
Type B rated current I_n [A]		20	25	32	40	50	63	80	100
Selectivity limiting current I_s [A]		230	285	365	450	550	680	850	1020
Downstream side FAZ Characteristic B	2	x	x	x	x	x	x	x	x
	3	x	x	x	x	x	x	x	x
	4	x	x	x	x	x	x	x	x
	6	x	x	x	x	x	x	x	x
	10	x	x	x	x	x	x	x	x
	13	x	x	x	x	x	x	x	x
	16	x	x	x	x	x	x	x	x
	20		x	x	x	x	x	x	x
	25			x	x	x	x	x	x
	32				x	x	x	x	x
	40					x	x	x	x
	50						x	x	x
	63							x	x

Upstream side →		PLHT Characteristic D							
Type B rated current I_n [A]		20	25	32	40	50	63	80	100
Selectivity limiting current I_s [A]		230	285	365	450	550	680	850	1020
Downstream side FAZ Characteristic C	0.5	x	x	x	x	x	x	x	x
	1	x	x	x	x	x	x	x	x
	2	x	x	x	x	x	x	x	x
	3	x	x	x	x	x	x	x	x
	4	x	x	x	x	x	x	x	x
	6	x	x	x	x	x	x	x	x
	8	x	x	x	x	x	x	x	x
	10	x	x	x	x	x	x	x	x
	13	x	x	x	x	x	x	x	x
	16	x	x	x	x	x	x	x	x
	20		x	x	x	x	x	x	x
	25			x	x	x	x	x	x
	32				x	x	x	x	x
	40					x	x	x	x
50						x	x	x	
63							x	x	

Upstream side →		PLHT Characteristic D							
Type B rated current I_n [A]		20	25	32	40	50	63	80	100
Selectivity limiting current I_s [A]		230	285	365	450	550	680	850	1020
Downstream side FAZ Characteristic D	2	x	x	x	x	x	x	x	x
	4	x	x	x	x	x	x	x	x
	6	x	x	x	x	x	x	x	x
	10	x	x	x	x	x	x	x	x
	13	x	x	x	x	x	x	x	x
	16	x	x	x	x	x	x	x	x
	20		x	x	x	x	x	x	x
	25			x	x	x	x	x	x
32				x	x	x	x	x	
40					x	x	x	x	

FAZ | Specifications



Influence of the Line Frequency

On the Instantaneous Tripping Current I_{MA}

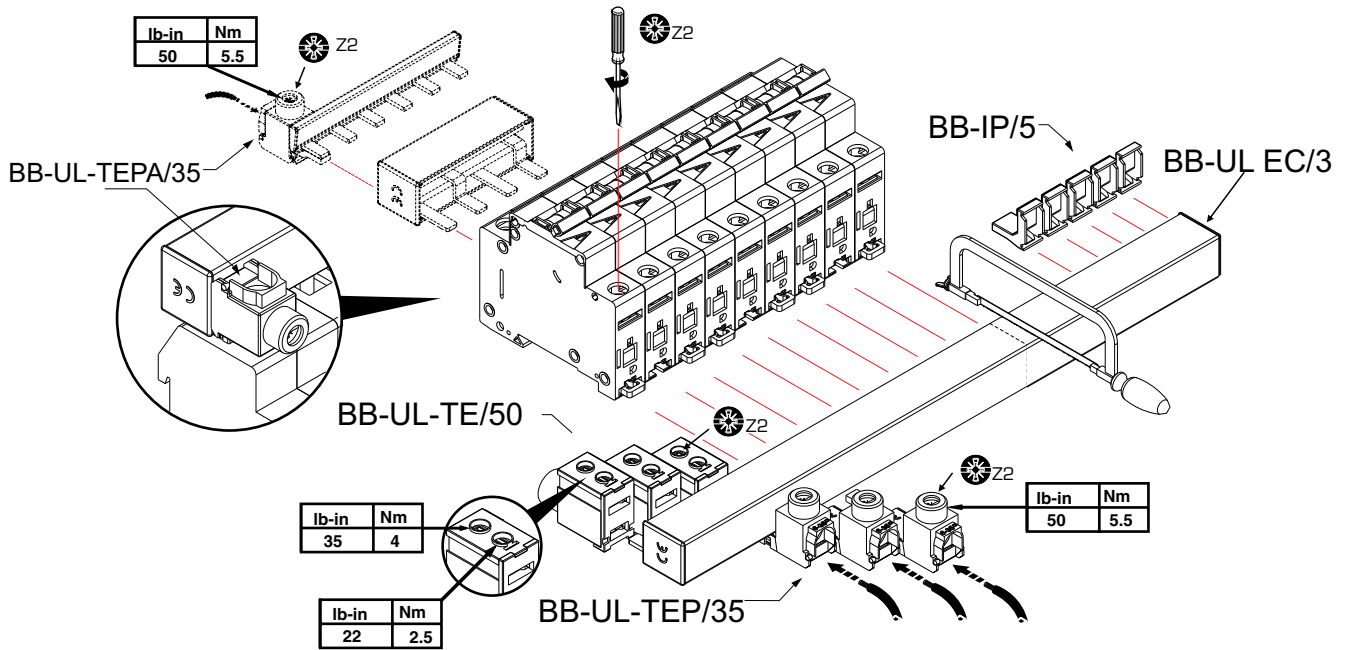

	Line Frequency f [Hz]						
	$16\frac{2}{3}$	50	60	100	200	300	400
$I_{MA}(f)/I_{MA}(50\text{Hz})$ [%]	91	100	101	106	115	134	141

UL508 Busbars for FAZ

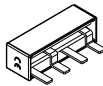

BB-UL-TE/50		
	UL508	EN/IEC 60947-2
U_e	480 V AC	240/690V AC
f	50/60 Hz	50/60 Hz
I_e	115 A @ 40°C	160 A @ 30°C
	#1-14 AWG 60/75°C Cu	1.5 – 50 mm ² Cu
	0.56 in	14 mm

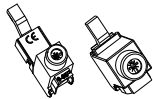
BB-UL		
	UL508	EN/IEC 60947-2
U_e	480 V AC	690V AC
f	50/60 Hz	
I_{pk}	10kA	15kA
I_e	18mm ²	25mm ²
Infeed at the start of the busbar	80A @ 40 °C	100A @ 30°C
Infeed at the center of the busbar	160A @ 40°C	200A @ 30°C

BB-UL-TEP/35 / BB-UL-TEPA/35		
	UL508	EN/IEC 60947-2
U_e	480 V AC	240/690V AC
f	50/60 Hz	50/60 Hz
I_e	115 A @ 40°C	80 A @ 30°C
	#2-14 AWG 60/75°C Cu	2.5 – 35 mm ² Cu
	0.56 in	14 mm







* -UL508 SHORT CIRCUIT RATINGS

-SUITABLE FOR USE ON A CIRCUIT CAPABLE OF DELIVERING NOT MORE THAN 10,000 RMS SYMETRICAL AMPERES, 600 VOLTS MAXIMUM.

-SUITABLE FOR USE ON A CIRCUIT CAPABLE OF DELIVERING NOT MORE THAN 100,000 RMS SYMETRICAL AMPERES, 600 VOLTS MAXIMUM WHEN PROTECTED BY A CLASS J FUSE RATED 175A.



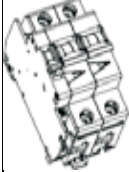



FAZ | Busbars

BB Busbars

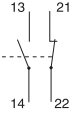
Article No.							
121981	BB-UL-18/1P-1M/57	57	-	-	-	-	-
121982	BB-UL-18/2P-2M/56	-	28	-	-	-	-
121983	BB-UL-18/3P-3M/57	-	-	19	-	-	-
121984	BB-UL-18/1P-1,5M/37	-	-	-	37	-	-
121987	BB-UL-18/2P+AS-2,5M/46	-	-	-	-	23	-
121988	BB-UL-18/3P+AS-3,5M/48	-	-	-	-	-	16
121989	BB-UL-25/1P-1M/57	57	-	-	-	-	-
121990	BB-UL-25/2P-2M/56	-	28	-	-	-	-
121991	BB-UL-25/3P-3M/57	-	-	19	-	-	-
121992	BB-UL-25/1P-1,5M/37	-	-	-	37	-	-
121995	BB-UL-25/2P+AS-2,5M/46	-	-	-	-	23	-
121996	BB-UL-25/3P+AS-3,5M/48	-	-	-	-	-	16
121997	BB-UL-TEP/35	-	-	-	-	-	-
in prep.	BB-UL-TEPA/35	-	-	-	-	-	-
121998	BB-UL-TE/50	-	-	-	-	-	-
121999	BB-IP/5	-	-	-	-	-	-
122000	BB-UL-EC/1	-	-	-	-	-	-
122001	BB-UL-EC/3	-	-	-	-	-	-

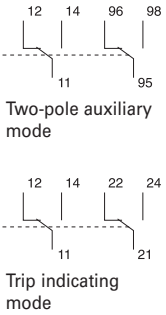
FAZ | Accessories for FAZ-MCBs

Auxiliary Contacts and Voltage Trips

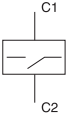
	Circuit Diagram	Description	Rated Operational Voltage	Type Designation	Article No.	Units per package
		Standard Auxiliary Contact <ul style="list-style-type: none"> • 1NO/1NC • Installs on left side of FAZ or shunt trip • Max. one per FAZ (1077) device • Switches when FAZ is tripped electrically or manually 	230 Vac	FAZ-XHIN11	286054	1
	 <p>Two-pole auxiliary mode</p> <p>Trip indicating mode</p>	Auxiliary/Trip Indicating Contact <ul style="list-style-type: none"> • Small selector screw changes mode • Two Form C (changeover) contacts • Installs on left side of FAZ or shunt trip • Auxiliary contacts switch when FAZ is tripped electrically or manually • Trip indicating contact switches only when FAZ is tripped electrically 	230 Vac	FAZ-XAM002	262414	1
		Undervoltage Trip <ul style="list-style-type: none"> • Prevents FAZ from operating unless voltage is present • Installs on left side of FAZ • Includes test button 	115 Vac 230 Vac 400 Vac	FAZ-XUA(115VAC) FAZ-XUA(230VAC) FAZ-XUA(400VAC)	212049 212051 212053	1 1 1
		Shunt Trip <ul style="list-style-type: none"> • Allows remote trip of FAZ • Installs on left side of FAZ 	12–110 Vac 12–60 Vdc 110–415 Vac 110–230 Vdc	FAZ-XAA-C-12-110VAC FAZ-XAA-C-110-415VAC	278518 278519	1 1
		Padlock Hasp (for all FAZ) <ul style="list-style-type: none"> • Prevents reactivation of the device during maintenance • Holds one padlock 		IS/SPE-1TE	101911	1

Allowable Combinations of Accessories

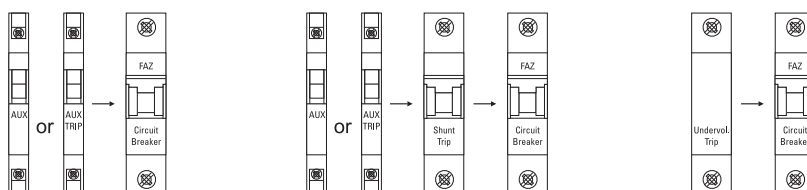

FAZ | Accessories for FAZ-MCBs

Specifications

Technical Data

	FAZ-XHIN FAZ-XAM002	FAZ-XAA-C	FAZ-XUA
Electrical			
Contact function	1A + 1B 2 C/O	—	—
Rated operational voltage U_n	250 Vac	—	115 Vac 230 Vac 400 Vac
Voltage range	—	12–110 Vac 12–60 Vdc	—
Voltage range	—	110–415 Vac 110–230 Vdc	—
Closing threshold [$\times U_n$]	—	—	0.8
Tripping threshold [$\times U_n$]	—	—	0.5
Rated frequency f	50/60 Hz	50/60 Hz	50/60 Hz
General use (UL/CSA)			
AC—230/240 Vac	2/2A	—	—
DC—110/120 Vdc	0.5/0.5A	—	—
Pilot duty	A600/Q600	—	—
Conventional free air thermal current I_{th}	4A	—	—
Rated operational current			
AC-13 I_e	3A (250 Vac)	—	—
AC-15 I_e	2A (250 Vac)	—	—
DC-13 I_e	0.5A (110 Vdc)	—	—
Rated insulation voltage U_i	250 Vac	—	—
Minimum operating voltage per contract U_{min}	5 Vdc	—	—
Rated impulse withstand voltage (1.2/50 μ) U_{imp}	2.5 kV	—	—
Rated conditional short-circuit current			
with 6A back-up fuse I_{SC}	1 kA	—	—
Max. admissible back-up fuse	4A gL	—	—
Mechanical			
Standard front dimension	45 mm	45 mm	45 mm
Device height	80 mm	80 mm	80 mm
Mounting width	8.8 mm	17.6 mm	17.8 mm
Degree of protection enclosed	IP40	IP40	IP40
Terminal protection	Protection against electric shock to IEC 536	Protection against electric shock to IEC 536	Protection against electric shock to IEC 536
Terminals	Lift terminals	Twin-purpose terminals	Twin-purpose terminals
Terminal capacity [mm ²]			
Solid	0.5–2.5	1–2.5	2 x (1–2.5)
Flexible	0.5–2.5	1–2.5	2 x (1–2.5)
Tightening torque of terminal screws	0.8–1.0 Nm (7–9 lb-in)	2.4 Nm (21 lb-in)	0.8 Nm (7 lb-in)

FAZ | Accessories for FAZ-MCBs

Dimensions (mm) Accessories

Auxiliary Contacts

FAZ-XHI11

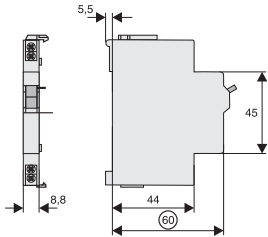

FAZ-XAM002

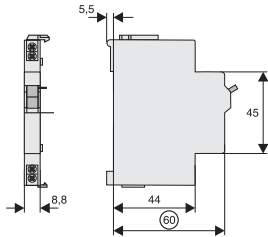

Shunt Releases

FAZ-XAA

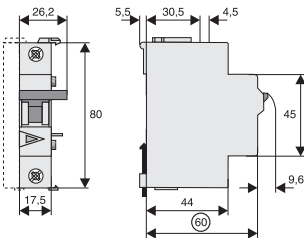

Undervoltage Releases

FAZ-XUA

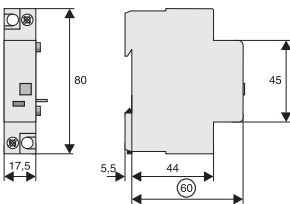

FAZ-T | Characteristic B

FAZ-T Miniature Circuit Breakers (MCBs)

Characteristic B

Rated current I_n (A)	Rated voltage IEC/EN 60898-1 (V)	Breaking capacity acc. to IEC/EN 60898-1 (kA)	Rated voltage IEC/EN 60947-2 (V)	Breaking capacity acc. to IEC/EN 60947-2 (kA)	Type Designation	Article No.	Units per package
----------------------------	---	---	---	---	---------------------	-------------	-------------------------

SG12411



1-pole

1	240/415	15	240	25	FAZT-B1/1	240770	12/120
2	240/415	15	240	25	FAZT-B2/1	240771	12/120
3	240/415	15	240	25	FAZT-B3/1	240772	12/120
4	240/415	15	240	25	FAZT-B4/1	240777	12/120
6	240/415	15	240	25	FAZT-B6/1	240782	12/120
10	240/415	15	240	25	FAZT-B10/1	240787	12/120
12	240/415	15	240	25	FAZT-B12/1	240792	12/120
13	240/415	15	240	25	FAZT-B13/1	240793	12/120
15	240/415	15	240	25	FAZT-B15/1	240794	12/120
16	240/415	15	240	25	FAZT-B16/1	240795	12/120
20	240/415	15	240	25	FAZT-B20/1	240796	12/120
25	240/415	15	240	25	FAZT-B25/1	240797	12/120
32	240/415	10	240	20	FAZT-B32/1	141907	12/120
40	240/415	10	240	20	FAZT-B40/1	141908	12/120

SG12711



1+N-pole

1	240	15	240	25	FAZT-B1/1N	240994	1/60
2	240	15	240	25	FAZT-B2/1N	240995	1/60
3	240	15	240	25	FAZT-B3/1N	240996	1/60
4	240	15	240	25	FAZT-B4/1N	240997	1/60
6	240	15	240	25	FAZT-B6/1N	240998	1/60
10	240	15	240	25	FAZT-B10/1N	240999	1/60
12	240	15	240	25	FAZT-B12/1N	241000	1/60
13	240	15	240	25	FAZT-B13/1N	241001	1/60
15	240	15	240	25	FAZT-B15/1N	241005	1/60
16	240	15	240	25	FAZT-B16/1N	241009	1/60
20	240	15	240	25	FAZT-B20/1N	241015	1/60
25	240	15	240	25	FAZT-B25/1N	241019	1/60
32	240	10	240	20	FAZT-B32/1N	142509	1/60
40	240	10	240	20	FAZT-B40/1N	142510	1/60

SG12811



2-pole

1	415	15	240/415	25	FAZT-B1/2	240820	1/60
2	415	15	240/415	25	FAZT-B2/2	240821	1/60
3	415	15	240/415	25	FAZT-B3/2	240822	1/60
4	415	15	240/415	25	FAZT-B4/2	240823	1/60
6	415	15	240/415	25	FAZT-B6/2	240824	1/60
10	415	15	240/415	25	FAZT-B10/2	240825	1/60
12	415	15	240/415	25	FAZT-B12/2	240826	1/60
13	415	15	240/415	25	FAZT-B13/2	240827	1/60
15	415	15	240/415	25	FAZT-B15/2	240828	1/60
16	415	15	240/415	25	FAZT-B16/2	240829	1/60
20	415	15	240/415	25	FAZT-B20/2	240830	1/60
25	415	15	240/415	25	FAZT-B25/2	240831	1/60
32	415	10	240/415	20	FAZT-B32/2	142485	1/60
40	415	10	240/415	20	FAZT-B40/2	142486	1/60

FAZ-T | Characteristic B

Rated current I_n (A)	Rated voltage IEC/EN 60898-1 (V)	Breaking capacity acc. to IEC/EN 60898-1 (kA)	Rated voltage IEC/EN 60947-2 (V)	Breaking capacity acc. to IEC/EN 60947-2 (kA)	Type Designation	Article No.	Units per package
----------------------------	---	---	---	---	---------------------	-------------	-------------------------

SG13011



3-pole

1	415	15	240/415	25	FAZT-B1/3	240874	1/40
2	415	15	240/415	25	FAZT-B2/3	240875	1/40
3	415	15	240/415	25	FAZT-B3/3	240876	1/40
4	415	15	240/415	25	FAZT-B4/3	240877	1/40
6	415	15	240/415	25	FAZT-B6/3	240878	1/40
10	415	15	240/415	25	FAZT-B10/3	240879	1/40
12	415	15	240/415	25	FAZT-B12/3	240880	1/40
13	415	15	240/415	25	FAZT-B13/3	240881	1/40
15	415	15	240/415	25	FAZT-B15/3	240882	1/40
16	415	15	240/415	25	FAZT-B16/3	240883	1/40
20	415	15	240/415	25	FAZT-B20/3	240884	1/40
25	415	15	240/415	25	FAZT-B25/3	240885	1/40
32	415	10	240/415	20	FAZT-B32/3	142493	1/40
40	415	10	240/415	20	FAZT-B40/3	142494	1/40

SG13211



3+N-pole

1	415	15	240/415	25	FAZT-B1/3N	241060	1/30
2	415	15	240/415	25	FAZT-B2/3N	241065	1/30
3	415	15	240/415	25	FAZT-B3/3N	241070	1/30
4	415	15	240/415	25	FAZT-B4/3N	241075	1/30
6	415	15	240/415	25	FAZT-B6/3N	241080	1/30
10	415	15	240/415	25	FAZT-B10/3N	241085	1/30
12	415	15	240/415	25	FAZT-B12/3N	241090	1/30
13	415	15	240/415	25	FAZT-B13/3N	241095	1/30
15	415	15	240/415	25	FAZT-B15/3N	241100	1/30
16	415	15	240/415	25	FAZT-B16/3N	241105	1/30
20	415	15	240/415	25	FAZT-B20/3N	241110	1/30
25	415	15	240/415	25	FAZT-B25/3N	241115	1/30
32	415	10	240/415	20	FAZT-B32/3N	142517	1/30
40	415	10	240/415	20	FAZT-B40/3N	142518	1/30

SG13111



4-pole

1	415	15	240/415	25	FAZT-B1/4	240922	1/30
2	415	15	240/415	25	FAZT-B2/4	240927	1/30
3	415	15	240/415	25	FAZT-B3/4	240930	1/30
4	415	15	240/415	25	FAZT-B4/4	240931	1/30
6	415	15	240/415	25	FAZT-B6/4	240932	1/30
10	415	15	240/415	25	FAZT-B10/4	240933	1/30
12	415	15	240/415	25	FAZT-B12/4	240934	1/30
13	415	15	240/415	25	FAZT-B13/4	240935	1/30
15	415	15	240/415	25	FAZT-B15/4	240936	1/30
16	415	15	240/415	25	FAZT-B16/4	240937	1/30
20	415	15	240/415	25	FAZT-B20/4	240938	1/30
25	415	15	240/415	25	FAZT-B25/4	240939	1/30
32	415	10	240/415	20	FAZT-B32/4	142501	1/30
40	415	10	240/415	20	FAZT-B40/4	142502	1/30

FAZ-T | Characteristic C

FAZ-T Miniature Circuit Breakers (MCBs)

Characteristic C

SG12411



Rated current I_n (A)	Rated voltage IEC/EN 60898-1 (V)	Breaking capacity acc. to IEC/EN 60898-1 (kA)	Rated voltage IEC/EN 60947-2 (V)	Breaking capacity acc. to IEC/EN 60947-2 (kA)	Type Designation	Article No.	Units per package
----------------------------	---	---	---	---	---------------------	-------------	-------------------------

1-pole

1	240/415	15	240	25	FAZT-C1/1	240798	12/120
2	240/415	15	240	25	FAZT-C2/1	240799	12/120
3	240/415	15	240	25	FAZT-C3/1	240800	12/120
4	240/415	15	240	25	FAZT-C4/1	240801	12/120
6	240/415	15	240	25	FAZT-C6/1	240802	12/120
10	240/415	15	240	25	FAZT-C10/1	240803	12/120
12	240/415	15	240	25	FAZT-C12/1	240804	12/120
13	240/415	15	240	25	FAZT-C13/1	240805	12/120
15	240/415	15	240	25	FAZT-C15/1	240806	12/120
16	240/415	15	240	25	FAZT-C16/1	240807	12/120
20	240/415	15	240	25	FAZT-C20/1	240808	12/120
25	240/415	15	240	25	FAZT-C25/1	240809	12/120
32	240/415	10	240	20	FAZT-C32/1	141909	12/120
40	240/415	10	240	20	FAZT-C40/1	142480	12/120

SG12711



1+N-pole

1	240	15	240	25	FAZT-C1/1N	241022	1/60
2	240	15	240	25	FAZT-C2/1N	241023	1/60
3	240	15	240	25	FAZT-C3/1N	241024	1/60
4	240	15	240	25	FAZT-C4/1N	241025	1/60
6	240	15	240	25	FAZT-C6/1N	241026	1/60
10	240	15	240	25	FAZT-C10/1N	241027	1/60
12	240	15	240	25	FAZT-C12/1N	241028	1/60
13	240	15	240	25	FAZT-C13/1N	241029	1/60
15	240	15	240	25	FAZT-C15/1N	241030	1/60
16	240	15	240	25	FAZT-C16/1N	241034	1/60
20	240	15	240	25	FAZT-C20/1N	241038	1/60
25	240	15	240	25	FAZT-C25/1N	241044	1/60
32	240	10	240	20	FAZT-C32/1N	142511	1/60
40	240	10	240	20	FAZT-C40/1N	142512	1/60

SG12811



2-pole

1	415	15	240/415	25	FAZT-C1/2	240832	1/60
2	415	15	240/415	25	FAZT-C2/2	240833	1/60
3	415	15	240/415	25	FAZT-C3/2	240838	1/60
4	415	15	240/415	25	FAZT-C4/2	240843	1/60
6	415	15	240/415	25	FAZT-C6/2	240850	1/60
10	415	15	240/415	25	FAZT-C10/2	240855	1/60
12	415	15	240/415	25	FAZT-C12/2	240858	1/60
13	415	15	240/415	25	FAZT-C13/2	240859	1/60
15	415	15	240/415	25	FAZT-C15/2	240860	1/60
16	415	15	240/415	25	FAZT-C16/2	240861	1/60
20	415	15	240/415	25	FAZT-C20/2	240862	1/60
25	415	15	240/415	25	FAZT-C25/2	240863	1/60
32	415	10	240/415	20	FAZT-C32/2	142487	1/60
40	415	10	240/415	20	FAZT-C40/2	142488	1/60

FAZ-T | Characteristic C

Rated current I_n (A)	Rated voltage IEC/EN 60898-1 (V)	Breaking capacity acc. to IEC/EN 60898-1 (kA)	Rated voltage IEC/EN 60947-2 (V)	Breaking capacity acc. to IEC/EN 60947-2 (kA)	Type Designation	Article No.	Units per package
----------------------------	---	---	---	---	---------------------	-------------	-------------------------

SG13011



3-pole

1	415	15	240/415	25	FAZT-C1/3	240886	1/40
2	415	15	240/415	25	FAZT-C2/3	240887	1/40
3	415	15	240/415	25	FAZT-C3/3	240888	1/40
4	415	15	240/415	25	FAZT-C4/3	240889	1/40
6	415	15	240/415	25	FAZT-C6/3	240890	1/40
10	415	15	240/415	25	FAZT-C10/3	240891	1/40
12	415	15	240/415	25	FAZT-C12/3	240892	1/40
13	415	15	240/415	25	FAZT-C13/3	240893	1/40
15	415	15	240/415	25	FAZT-C15/3	240894	1/40
16	415	15	240/415	25	FAZT-C16/3	240895	1/40
20	415	15	240/415	25	FAZT-C20/3	240896	1/40
25	415	15	240/415	25	FAZT-C25/3	240897	1/40
32	415	10	240/415	20	FAZT-C32/3	142495	1/40
40	415	10	240/415	20	FAZT-C40/3	142496	1/40

SG13211



3+N-pole

1	415	15	240/415	25	FAZT-C1/3N	241120	1/30
2	415	15	240/415	25	FAZT-C2/3N	241125	1/30
3	415	15	240/415	25	FAZT-C3/3N	241130	1/30
4	415	15	240/415	25	FAZT-C4/3N	241135	1/30
6	415	15	240/415	25	FAZT-C6/3N	241140	1/30
10	415	15	240/415	25	FAZT-C10/3N	241145	1/30
12	415	15	240/415	25	FAZT-C12/3N	241150	1/30
13	415	15	240/415	25	FAZT-C13/3N	241155	1/30
15	415	15	240/415	25	FAZT-C15/3N	241160	1/30
16	415	15	240/415	25	FAZT-C16/3N	241165	1/30
20	415	15	240/415	25	FAZT-C20/3N	241170	1/30
25	415	15	240/415	25	FAZT-C25/3N	241175	1/30
32	415	10	240/415	20	FAZT-C32/3N	142519	1/30
40	415	10	240/415	20	FAZT-C40/3N	142520	1/30

SG13111



4-pole

1	415	15	240/415	25	FAZT-C1/4	240940	1/30
2	415	15	240/415	25	FAZT-C2/4	240941	1/30
3	415	15	240/415	25	FAZT-C3/4	240945	1/30
4	415	15	240/415	25	FAZT-C4/4	240949	1/30
6	415	15	240/415	25	FAZT-C6/4	240955	1/30
10	415	15	240/415	25	FAZT-C10/4	240959	1/30
12	415	15	240/415	25	FAZT-C12/4	240962	1/30
13	415	15	240/415	25	FAZT-C13/4	240963	1/30
15	415	15	240/415	25	FAZT-C15/4	240964	1/30
16	415	15	240/415	25	FAZT-C16/4	240965	1/30
20	415	15	240/415	25	FAZT-C20/4	240966	1/30
25	415	15	240/415	25	FAZT-C25/4	240967	1/30
32	415	10	240/415	20	FAZT-C32/4	142503	1/30
40	415	10	240/415	20	FAZT-C40/4	142504	1/30

FAZ-T | Characteristic D

FAZ-T Miniature Circuit Breakers (MCBs)

Characteristic D

SG12411



Rated current I_n (A)	Rated voltage IEC/EN 60898-1 (V)	Breaking capacity acc. to IEC/EN 60898-1 (kA)	Rated voltage IEC/EN 60947-2 (V)	Breaking capacity acc. to IEC/EN 60947-2 (kA)	Type Designation	Article No.	Units per package
----------------------------	---	---	---	---	---------------------	-------------	-------------------------

1-pole

1	240/415	15	240	25	FAZT-D1/1	240810	12/120
2	240/415	15	240	25	FAZT-D2/1	240811	12/120
3	240/415	15	240	25	FAZT-D3/1	240812	12/120
4	240/415	15	240	25	FAZT-D4/1	240813	12/120
6	240/415	15	240	25	FAZT-D6/1	240814	12/120
10	240/415	15	240	25	FAZT-D10/1	240815	12/120
12	240/415	15	240	25	FAZT-D12/1	240816	12/120
13	240/415	15	240	25	FAZT-D13/1	240817	12/120
15	240/415	15	240	20	FAZT-D15/1	240818	12/120
16	240/415	15	240	20	FAZT-D16/1	240819	12/120
20	240/415	10	240	20	FAZT-D20/1	142481	12/120
25	240/415	10	240	15	FAZT-D25/1	142482	12/120
32	240/415	10	240	15	FAZT-D32/1	142483	12/120
40	240/415	10	240	15	FAZT-D40/1	142484	12/120

SG12711



1+N-pole

1	240	15	240	25	FAZT-D1/1N	241048	1/60
2	240	15	240	25	FAZT-D2/1N	241051	1/60
3	240	15	240	25	FAZT-D3/1N	241052	1/60
4	240	15	240	25	FAZT-D4/1N	241053	1/60
6	240	15	240	25	FAZT-D6/1N	241054	1/60
10	240	15	240	25	FAZT-D10/1N	241055	1/60
12	240	15	240	25	FAZT-D12/1N	241056	1/60
13	240	15	240	25	FAZT-D13/1N	241057	1/60
15	240	15	240	20	FAZT-D15/1N	241058	1/60
16	240	15	240	20	FAZT-D16/1N	241059	1/60
20	240	10	240	20	FAZT-D20/1N	142513	1/60
25	240	10	240	15	FAZT-D25/1N	142514	1/60
32	240	10	240	15	FAZT-D32/1N	142515	1/60
40	240	10	240	15	FAZT-D40/1N	142516	1/60

SG12811



2-pole

1	415	15	240/415	25	FAZT-D1/2	240864	1/60
2	415	15	240/415	25	FAZT-D2/2	240865	1/60
3	415	15	240/415	25	FAZT-D3/2	240866	1/60
4	415	15	240/415	25	FAZT-D4/2	240867	1/60
6	415	15	240/415	25	FAZT-D6/2	240868	1/60
10	415	15	240/415	25	FAZT-D10/2	240869	1/60
12	415	15	240/415	25	FAZT-D12/2	240870	1/60
13	415	15	240/415	25	FAZT-D13/2	240871	1/60
15	415	15	240/415	20	FAZT-D15/2	240872	1/60
16	415	15	240/415	20	FAZT-D16/2	240873	1/60
20	415	10	240/415	20	FAZT-D20/2	142489	1/60
25	415	10	240/415	15	FAZT-D25/2	142490	1/60
32	415	10	240/415	15	FAZT-D32/2	142491	1/60
40	415	10	240/415	15	FAZT-D40/2	142492	1/60

FAZ-T | Characteristic D

Rated current I_n (A)	Rated voltage IEC/EN 60898-1 (V)	Breaking capacity acc. to IEC/EN 60898-1 (kA)	Rated voltage IEC/EN 60947-2 (V)	Breaking capacity acc. to IEC/EN 60947-2 (kA)	Type Designation	Article No.	Units per package
----------------------------	---	---	---	---	---------------------	-------------	-------------------------

SG13011



3-pole

1	415	15	240/415	25	FAZT-D1/3	240898	1/40
2	415	15	240/415	25	FAZT-D2/3	240899	1/40
3	415	15	240/415	25	FAZT-D3/3	240900	1/40
4	415	15	240/415	25	FAZT-D4/3	240901	1/40
6	415	15	240/415	25	FAZT-D6/3	240902	1/40
10	415	15	240/415	25	FAZT-D10/3	240903	1/40
12	415	15	240/415	25	FAZT-D12/3	240904	1/40
13	415	15	240/415	25	FAZT-D13/3	240905	1/40
15	415	15	240/415	25	FAZT-D15/3	240910	1/40
16	415	15	240/415	25	FAZT-D16/3	240915	1/40
20	415	10	240/415	20	FAZT-D20/3	142497	1/40
25	415	10	240/415	15	FAZT-D25/3	142498	1/40
32	415	10	240/415	15	FAZT-D32/3	142499	1/40
40	415	10	240/415	15	FAZT-D40/3	142500	1/40

SG13211



3+N-pole

1	415	15	240/415	25	FAZT-D1/3N	241180	1/30
2	415	15	240/415	25	FAZT-D2/3N	241181	1/30
3	415	15	240/415	25	FAZT-D3/3N	241182	1/30
4	415	15	240/415	25	FAZT-D4/3N	241183	1/30
6	415	15	240/415	25	FAZT-D6/3N	241184	1/30
10	415	15	240/415	25	FAZT-D10/3N	241185	1/30
12	415	15	240/415	25	FAZT-D12/3N	241186	1/30
13	415	15	240/415	25	FAZT-D13/3N	241187	1/30
15	415	15	240/415	25	FAZT-D15/3N	241188	1/30
16	415	15	240/415	25	FAZT-D16/3N	241189	1/30
20	415	10	240/415	20	FAZT-D20/3N	142521	1/30
25	415	10	240/415	15	FAZT-D25/3N	142522	1/30
32	415	10	240/415	15	FAZT-D32/3N	142523	1/30
40	415	10	240/415	15	FAZT-D40/3N	142524	1/30

SG13111



4-pole

1	415	15	240/415	25	FAZT-D1/4	240968	1/30
2	415	15	240/415	25	FAZT-D2/4	240969	1/30
3	415	15	240/415	25	FAZT-D3/4	240970	1/30
4	415	15	240/415	25	FAZT-D4/4	240971	1/30
6	415	15	240/415	25	FAZT-D6/4	240975	1/30
10	415	15	240/415	25	FAZT-D10/4	240979	1/30
12	415	15	240/415	25	FAZT-D12/4	240985	1/30
13	415	15	240/415	25	FAZT-D13/4	240989	1/30
15	415	15	240/415	25	FAZT-D15/4	240992	1/30
16	415	15	240/415	25	FAZT-D16/4	240993	1/30
20	415	10	240/415	20	FAZT-D20/4	142505	1/30
25	415	10	240/415	15	FAZT-D25/4	142506	1/30
32	415	10	240/415	15	FAZT-D32/4	142507	1/30
40	415	10	240/415	15	FAZT-D40/4	142508	1/30

FAZ-T | Specifications

Specifications

Technical data

		FAZ-T
Productstandard		IEC/EN 60947-2 IEC/EN 60898-1
Number of poles		1, 1p+N, 2, 3, 3p+N, 4
Mechanical specifications		
Device width		17.7 mm (1p), 27 mm (1p+N), 36 mm (2p), 54 mm (3p), 72mm (3p+N), 72 mm (4p)
Frame size		45 mm
Socket size		80 mm
Device depth		60 mm
Terminals		lift terminal
Terminal capacity rigid solid/stranded wire		1-25 mm ²
Terminal screw		M5 (with slotted screw acc. to EN ISO 4757-Z2, PZ2)
Terminal torque		max. 2.4 Nm
Snap on fixing		tristable (on DIN rail acc. to EN 50022)
Finger proof		acc.to VBG4, ÖVE EN-6
Degree of Protection (DIN VDE 0470)		
Surface mounted		IP 20
Built-in behind panel		IP 40
Contact position indicator		red / green
Electrical specifications		
Rated voltage	U_n	240/415 V
Rated current	I_n	Type B, C, D: 1, 2, 3, 4, 6, 10, 12, 13, 15, 16, 20, 25, 32, 40 A
Rated insulation voltage	U_i	440 V
Rated impulse withstand voltage	U_{imp}	4 kV (1.2/50) μ sec
Tripping characteristic		
Conventional non-tripping current		$I_{nt}=1.13 I_n$
Conventional tripping current		$I_t=1.45 I_n$
Reference temperature		30 °C
Temperature factor		0.4% /K
Instantaneous tripping current	I_{mt}	type B: $3 I_n < I_{mt} = 5 I_n \cdot t (I_{mt}) < 0,1 \text{ sec}$ type C: $5 I_n < I_{mt} = 10 I_n \cdot t (I_{mt}) < 0,1 \text{ sec}$ type D: $10 I_n < I_{mt} = 20 I_n \cdot t (I_{mt}) < 0,1 \text{ sec}$
Rated ultimate short-circuit braking capacity I_{cu} (IEC/EN 60947-2)		
	type B	1-25 A: 25 kA, 32-40 A: 20 kA
	type C	1-25 A: 25 kA, 32-40 A: 20 kA
	type D	1p/1p+N/2p - 1-13 A: 25 kA, 15-20 A: 20 kA, 25-40 A: 15 kA 3p/3p+N/4p - 1-16 A: 25 kA, 20 A: 20 kA, 25-40 A: 15 kA
Rated service short-circuit braking capacity I_{cs} (IEC/EN 60947-2)		for $I_{cu} = 25 \text{ kA} \rightarrow I_{cs} = 12.5 \text{ kA}$ for $I_{cu} = 20 \text{ kA} \rightarrow I_{cs} = 10 \text{ kA}$ for $I_{cu} = 15 \text{ kA} \rightarrow I_{cs} = 7.5 \text{ kA}$
Rated short-circuit braking capacity I_{cn} (IEC/EN 60898-1)		
	type B	1-25 A: 15 kA, 32-40 A: 10 kA
	type C	1-25 A: 15 kA, 32-40 A: 10 kA
	type D	1-16 A: 15 kA, 20-40 A: 10 kA
Selectivity class		3 (acc. to EN 60898)
Number of electrical operations		> 4000 (IEC/EN 60898)
Number of mechanical operations		> 10000 (IEC/EN 60947)
Climatic conditions		acc. to IEC 68-2 (25..55°C / 90..95% RH)

Connection diagrams

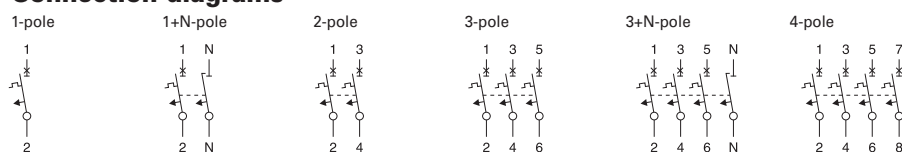

FAZ-T | Specifications

Dimensions (mm) FAZ-T

1-pole

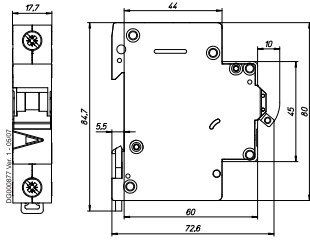
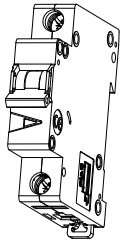

1+N-pole

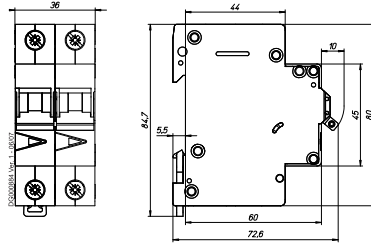
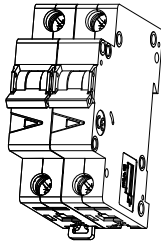

2-pole

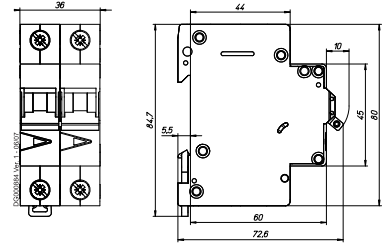
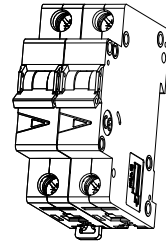

3-pole

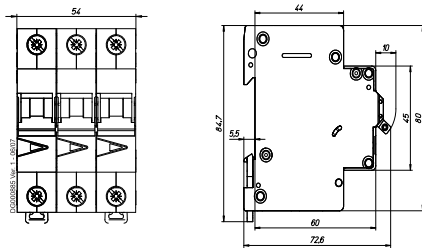
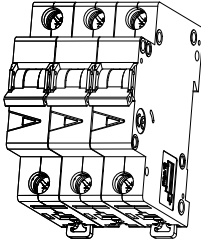

3+N-pole, 4-pole

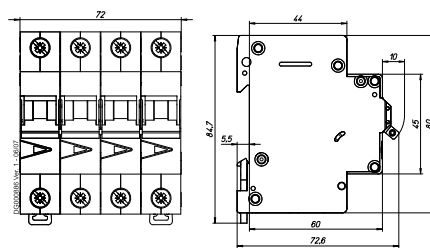
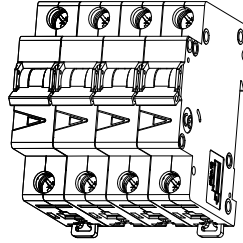

FAZ-T | Specifications

Tripping Characteristic FAZ-T

Characteristics B, C and D - EN60898

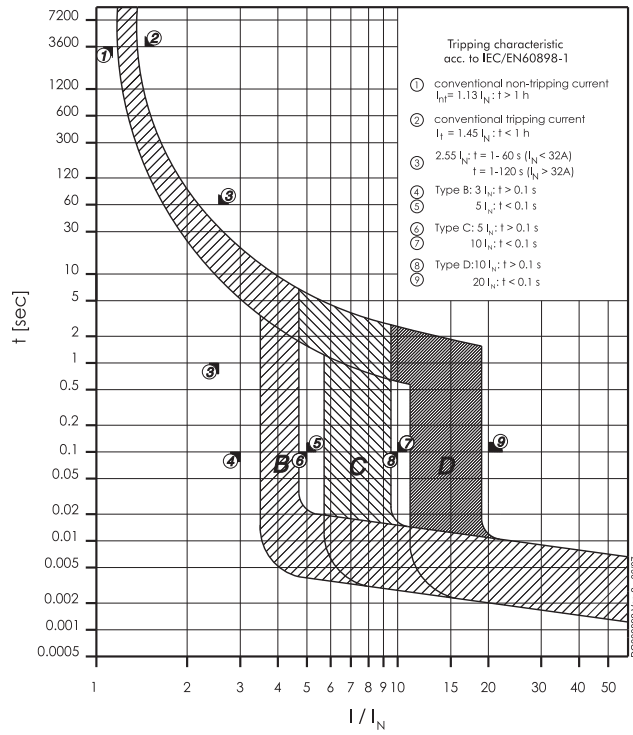

FAZ-T | Specifications

Power Loss at I_n FAZ-T

Type B

I_n [A]	1p	1pN	2p	3p	3pN*	4p
	P [W]	P [W]	P [W]	P [W]	P [W]	P [W]
1	1.6	1.7	3.1	4.7	4.8	6.3
2	1.4	1.5	2.8	4.1	4.3	5.5
3	2.5	2.7	5.0	7.6	7.8	10.1
4	1.4	1.6	2.9	4.4	4.5	5.8
6	1.8	2.0	3.6	5.5	5.6	7.3
10	1.9	2.1	3.9	5.9	6.1	7.8
12	2.8	3.2	5.9	8.7	9.0	11.5
13	2.5	2.9	5.3	7.8	8.1	10.3
15	2.1	2.4	4.4	6.5	6.7	8.6
16	2.2	2.6	4.7	6.9	7.2	9.1
20	3.2	3.6	6.6	9.8	10.1	13.0
25	3.0	3.5	6.4	9.4	9.7	12.4
32	3.7	4.4	8.1	12.1	12.5	15.8
40	3.4	4.1	7.5	11.2	11.5	14.6

*symmetrical load

Type C

I_n [A]	1p	1pN	2p	3p	3pN*	4p
	P [W]	P [W]	P [W]	P [W]	P [W]	P [W]
1	1.6	1.7	3.1	4.7	4.8	6.3
2	1.4	1.5	2.8	4.1	4.3	5.5
3	1.2	1.3	2.4	3.6	3.7	4.8
4	1.4	1.6	2.9	4.4	4.5	5.8
6	1.5	1.6	2.9	4.4	4.6	5.9
10	1.5	1.7	3.0	4.6	4.7	6.1
12	2.1	2.4	4.4	6.5	6.8	8.6
13	2.5	2.9	5.3	7.8	8.1	10.3
15	2.1	2.4	4.4	6.5	6.7	8.6
16	2.2	2.6	4.7	6.9	7.2	9.1
20	3.2	3.6	6.6	9.8	10.1	13.0
25	3.0	3.5	6.4	9.4	9.7	12.4
32	3.7	4.4	8.1	12.1	12.5	15.8
40	3.4	4.1	7.5	11.2	11.5	14.6

*symmetrical load

Type D

I_n [A]	1p	1pN	2p	3p	3pN*	4p
	P [W]	P [W]	P [W]	P [W]	P [W]	P [W]
1	0.8	0.9	1.6	2.4	2.5	3.2
2	1.0	1.1	2.0	3.0	3.1	4.0
3	1.2	1.3	2.4	3.6	3.7	4.8
4	1.4	1.6	2.9	4.4	4.5	5.8
6	1.5	1.6	2.9	4.4	4.6	5.9
10	1.5	1.7	3.0	4.6	4.7	6.1
12	1.7	2.0	3.6	5.3	5.4	7.0
13	1.9	2.2	4.0	5.9	6.1	7.8
15	2.1	2.4	4.4	6.5	6.7	8.6
16	2.2	2.6	4.7	6.9	7.2	9.1
20	2.0	2.2	4.1	6.1	6.2	8.1
25	2.5	2.9	5.2	7.7	7.9	10.2
32	3.4	4.0	7.4	11.1	11.4	14.5
40	3.2	3.8	7.0	10.4	10.7	13.6

*symmetrical load

FAZ-T | Specifications

Influence of Ambient Temperature FAZ-T

On Load Carrying Capacity (temperature derating)

I_N [A]	Ambient temperature T [°C]																
	-40	-30	-20	-10	0	10	20	30	35	40	45	50	55	60	65	70	75
1	1,3	1,2	1,2	1,2	1,1	1,1	1	1	0,99	0,97	0,95	0,93	0,9	0,89	0,87	0,85	0,83
2	2,6	2,5	2,4	2,3	2,2	2,2	2,1	2	2	1,9	1,9	1,9	1,8	1,8	1,7	1,7	1,7
3	3,8	3,7	3,6	3,5	3,4	3,3	3,1	3	3	2,9	2,8	2,8	2,7	2,7	2,6	2,5	2,5
4	5,1	5	4,8	4,7	4,5	4,3	4,2	4	3,9	3,9	3,8	3,7	3,6	3,5	3,5	3,4	3,3
6	7,7	7,5	7,2	7	6,7	6,5	6,3	6	5,9	5,8	5,7	5,6	5,4	5,3	5,2	5,1	5
10	13	12	12	12	11	11	10	10	9,9	9,7	9,5	9,3	9	8,9	8,7	8,5	8,3
12	15	15	14	14	13	13	13	12	12	12	11	11	11	11	10	10	10
13	17	16	16	15	15	14	14	13	13	13	12	12	12	12	11	11	11
15	19	19	18	17	17	16	16	15	15	15	14	14	14	13	13	13	12
16	20	20	19	19	18	17	17	16	16	15	15	15	14	14	14	14	13
20	26	25	24	23	22	22	21	20	20	19	19	19	18	18	17	17	17
25	32	31	30	29	28	27	26	25	25	24	24	23	23	22	22	21	21
32	41	40	38	37	36	35	33	32	32	31	30	30	29	28	28	27	26
40	51	50	48	47	45	43	42	40	39	39	38	37	36	35	35	34	33

Influence of the Line Frequency

On the Instantaneous Tripping Current I_{MA}

	Line Frequency f [Hz]						
	$16\frac{2}{3}$	50	60	100	200	300	400
$I_{MA}(f)/I_{MA}(50\text{Hz})$ [%]	91	100	101	106	115	134	141

Load rating in case of circuit breakers arranged one next to the other

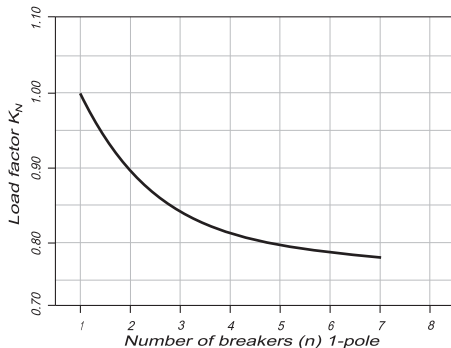

FAZ-T | Specifications

Maximum Let-Through Energy FAZ-T

Type B

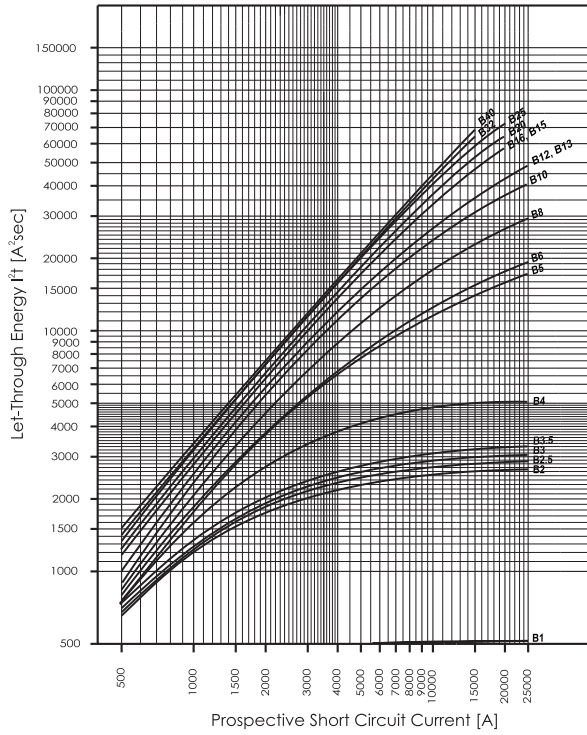

Type C

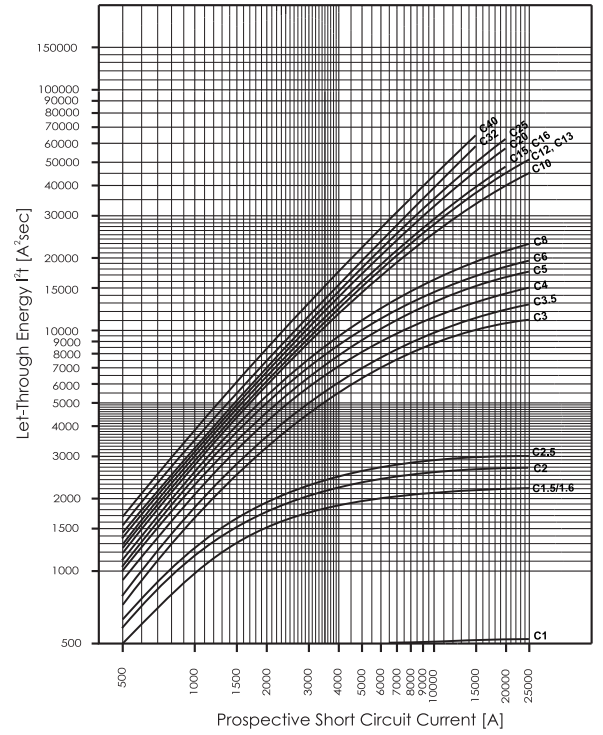

Type D

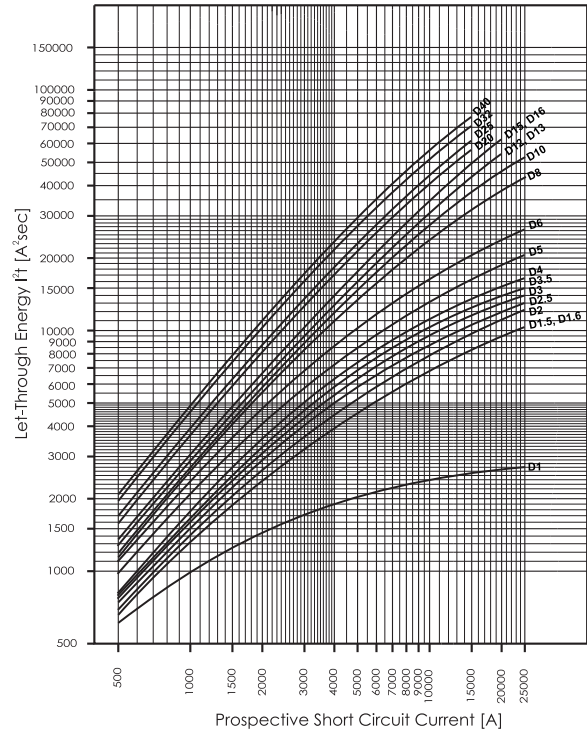

FAZ-T | Specifications

Maximum Let-Through Current FAZ-T

Type B

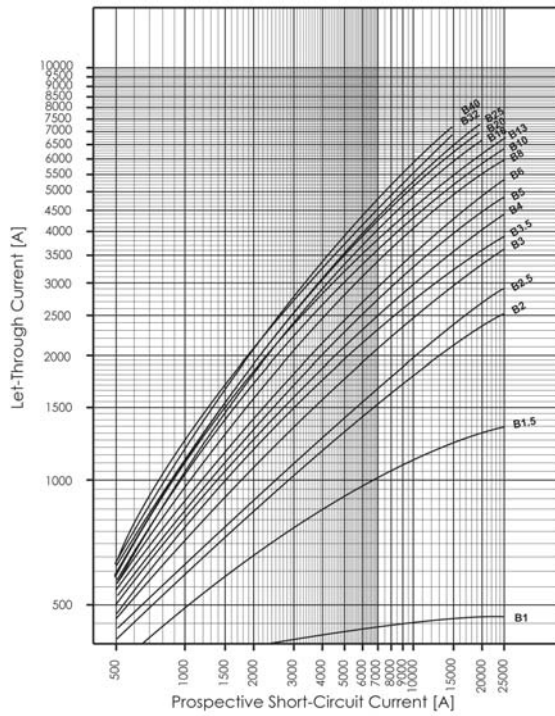

Type C

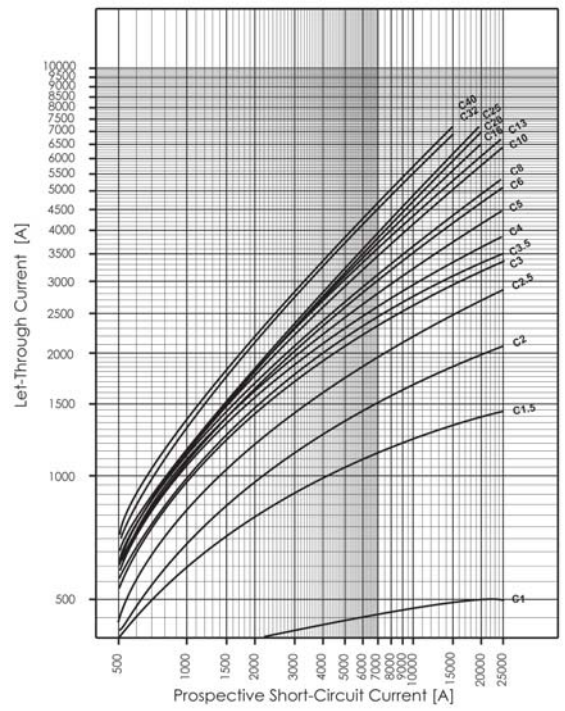

Type D

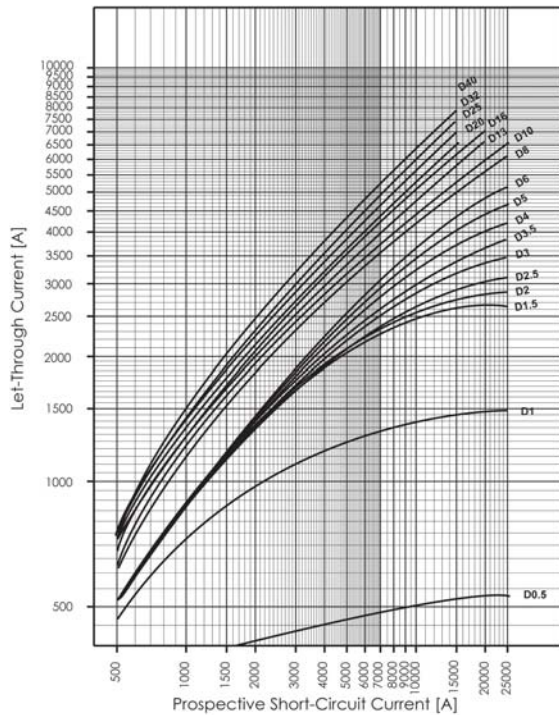

FAZ-...-DC | Characteristic C

FAZ-...-DC Miniature Circuit Breakers (MCBs) Characteristic C

Rated current I_n (A)	Rated voltage IEC/EN 60947-2 (V DC)	Breaking capacity acc. to IEC/EN 60947-2 (kA)	Type Designation	Article No.	Units per package
----------------------------	--	---	---------------------	-------------	-------------------------

SG08511



1-pole

2	220	10	FAZ-C2/1-DC	279122	12/120
3	250	10	FAZ-C3/1-DC	279123	12/120
4	250	10	FAZ-C4/1-DC	279124	12/120
6	250	10	FAZ-C6/1-DC	279125	12/120
10	250	10	FAZ-C10/1-DC	279126	12/120
13	250	10	FAZ-C13/1-DC	279127	12/120
16	250	10	FAZ-C16/1-DC	279128	12/120
20	250	10	FAZ-C20/1-DC	279129	12/120
25	250	10	FAZ-C25/1-DC	279130	12/120
32	250	10	FAZ-C32/1-DC	279131	12/120
40	250	10	FAZ-C40/1-DC	279132	12/120
50	250	10	FAZ-C50/1-DC	279133	12/120

SG08611



2-pole

2	440	10	FAZ-C2/2-DC	279134	1/60
3	500	10	FAZ-C3/2-DC	279135	1/60
4	500	10	FAZ-C4/2-DC	279136	1/60
6	500	10	FAZ-C6/2-DC	279137	1/60
10	500	10	FAZ-C10/2-DC	279138	1/60
13	500	10	FAZ-C13/2-DC	279139	1/60
16	500	10	FAZ-C16/2-DC	279140	1/60
20	500	10	FAZ-C20/2-DC	279141	1/60
25	500	10	FAZ-C25/2-DC	279142	1/60
32	500	10	FAZ-C32/2-DC	279143	1/60
40	500	10	FAZ-C40/2-DC	279144	1/60
50	500	10	FAZ-C50/2-DC	279145	1/60

FAZ-...-DC | Specifications

Specifications

Technical data

	FAZ-DC *)	
Productstandard	IEC/EN 60947-2	
Number of poles	1, 2	
Mechanical specifications		
Device width	17.7 mm (1p), 36 mm (2p)	
Frame size	45 mm	
Socket size	80 mm	
Device depth	60 mm	
Terminals	lift terminal	
Terminal capacity rigid solid/stranded wire	1-25 mm ²	
Terminal screw	M5 (with slotted screw acc. to EN ISO 4757-Z2, PZ2)	
Terminal torque	max. 2.4 Nm	
Snap on fixing	tristable (on DIN rail acc. to EN 50022)	
Finger proof	acc.to VBG4, ÖVE EN-6	
Degree of Protection (DIN VDE 0470)		
Surface mounted	IP 20	
Built-in behind panel	IP 40	
Contact position indicator	red / green	
Electrical specifications		
Rated voltage DC	U_n	2 A type: 220V (per pole) 3-50 A types: 250V (per pole)
Rated current	I_n	Type C: 2, 3, 4, 6, 10, 13, 16, 20, 25, 32, 40, 50 A
Rated insulation voltage	U_i	440 V
Rated impulse withstand voltage	U_{imp}	4 kV (1.2/50)µsec
Tripping characteristic		
Conventional non-tripping current	I_{nt}	$I_{nt}=1.13 I_n$
Conventional tripping current	I_t	$I_t=1.45 I_n$
Reference temperature		30 °C
Temperature factor		0.4% /K
Instantaneous tripping current	I_{mt}	type C: $7 I_n < I_{mt} = 15 I_n ; t(I_{mt}) < 0,1 \text{ sec}$
Rated short-circuit braking capacity	I_{cu}	10 kA
Selectivity class		3
Number of electrical operations		> 4000
Number of mechanical operations		> 20000
Climatic conditions		acc. to IEC 68-2 (25..55°C / 90..95% RH)

*) not for PV string protection!

Connection diagrams

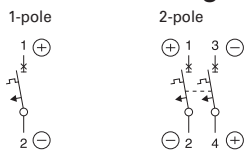

FAZ-...-DC | Specifications

Dimensions (mm) FAZ-...-DC

1-pole

2-pole

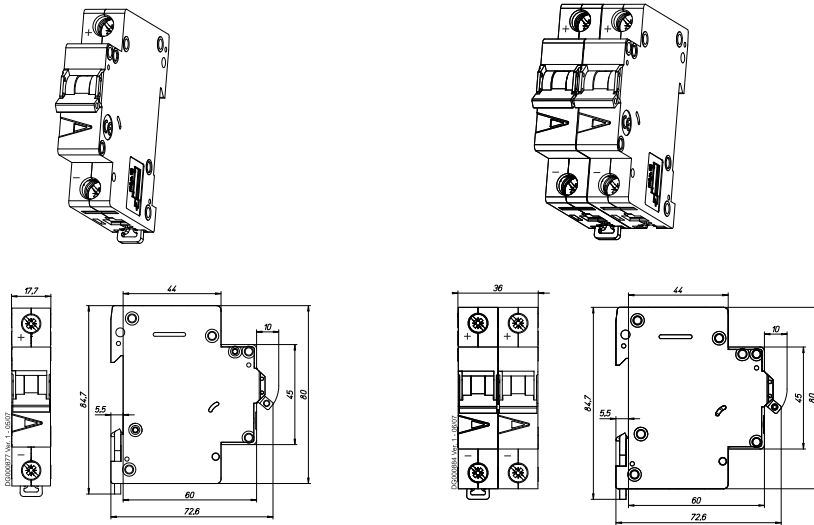

Connection examples FAZ-...-DC

Connection example at 250V=, 1-pole

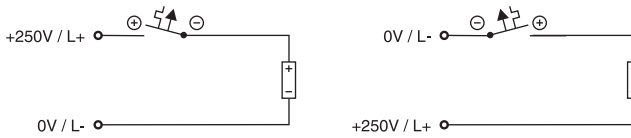

Connection example at 500V=, 2-pole

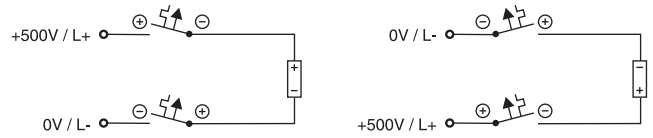

Tripping Characteristic FAZ-...-DC

Characteristics C - IEC/EN 60947-2

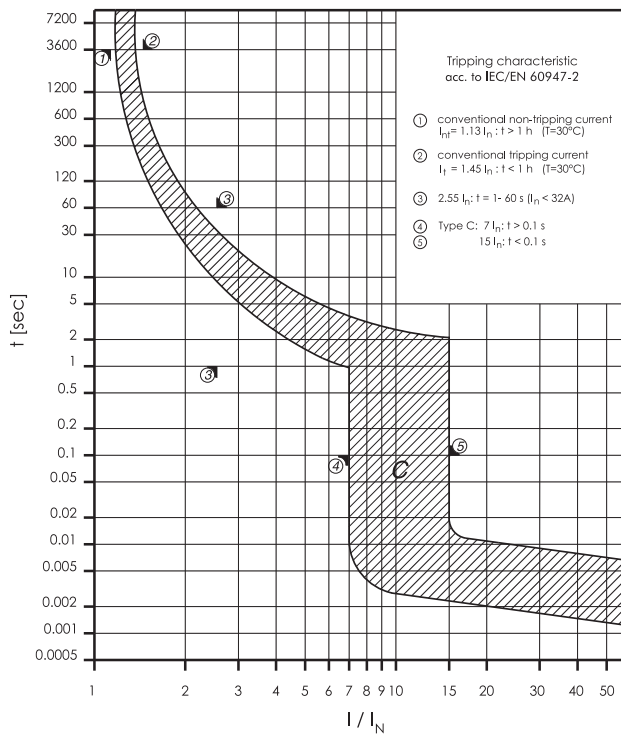

Maximum Let-Through Energy FAZ-...-DC

Type C

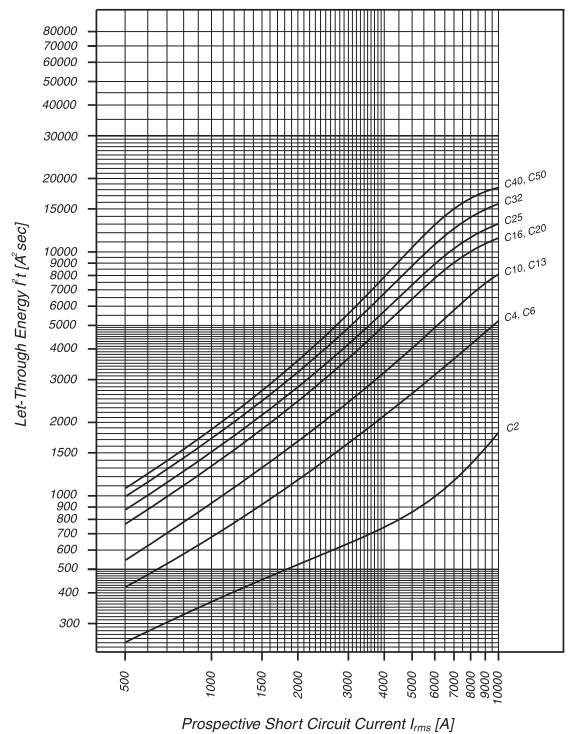

FAZ-...-NA | Characteristic B

FAZ-...-NA Miniature Circuit Breakers (MCBs)

Characteristic B

SG09011



Rated current I_n (A)	Rated voltage IEC/EN 60947-2 (V)	Breaking capacity acc. to IEC/EN 60947-2 (kA)	Rated voltage UL489 (V)	Breaking capacity acc. to UL489 (kA)	SWD	NFPA 79	Type Designation	Article No.	Units per package
----------------------------	---	---	-------------------------------	---	-----	---------	---------------------	-------------	-------------------------

1-pole

1	240/415	15	277	10	SWD	AWG 18	FAZ-B1/1-NA	132414	12/120
1,5	240/415	15	277	10	SWD	AWG 18	FAZ-B1,5/1-NA	132415	12/120
2	240/415	15	277	10	SWD	AWG 18	FAZ-B2/1-NA	132416	12/120
3	240/415	15	277	10	SWD	AWG 18	FAZ-B3/1-NA	132417	12/120
4	240/415	15	277	10	SWD	AWG 18	FAZ-B4/1-NA	132418	12/120
5	240/415	15	277	10	SWD	AWG 18	FAZ-B5/1-NA	132419	12/120
6	240/415	15	277	10	SWD	AWG 18	FAZ-B6/1-NA	132680	12/120
7	240/415	15	277	10	SWD	AWG 18	FAZ-B7/1-NA	132681	12/120
8	240/415	15	277	10	SWD	AWG 16	FAZ-B8/1-NA	132682	12/120
10	240/415	15	277	10	SWD	AWG 16	FAZ-B10/1-NA	132683	12/120
13	240/415	15	277	10	SWD		FAZ-B13/1-NA	132684	12/120
15	240/415	15	277	14	SWD		FAZ-B15/1-NA	132685	12/120
16	240/415	15	277	14	SWD		FAZ-B16/1-NA	132686	12/120
20	240/415	15	277	14	SWD		FAZ-B20/1-NA	132687	12/120
25	240/415	15	277	14			FAZ-B25/1-NA	132688	12/120
30	240/415	15	277	10			FAZ-B30/1-NA	132689	12/120
32	240/415	15	277	10			FAZ-B32/1-NA	132690	12/120
35	240/415	15	240	10			FAZ-B35/1-NA	132691	12/120
40	240/415	15	240	10			FAZ-B40/1-NA	132692	12/120

SG09111



2-pole

1	415	15	480Y/277	10	SWD	AWG 18	FAZ-B1/2-NA	132693	1/60
1,5	415	15	480Y/277	10	SWD	AWG 18	FAZ-B1,5/2-NA	132694	1/60
2	415	15	480Y/277	10	SWD	AWG 18	FAZ-B2/2-NA	132695	1/60
3	415	15	480Y/277	10	SWD	AWG 18	FAZ-B3/2-NA	132696	1/60
4	415	15	480Y/277	10	SWD	AWG 18	FAZ-B4/2-NA	132697	1/60
5	415	15	480Y/277	10	SWD	AWG 18	FAZ-B5/2-NA	132698	1/60
6	415	15	480Y/277	10	SWD	AWG 18	FAZ-B6/2-NA	132699	1/60
7	415	15	480Y/277	10	SWD	AWG 18	FAZ-B7/2-NA	132700	1/60
8	415	15	480Y/277	10	SWD	AWG 16	FAZ-B8/2-NA	132701	1/60
10	415	15	480Y/277	10	SWD	AWG 16	FAZ-B10/2-NA	132702	1/60
13	415	15	480Y/277	10	SWD		FAZ-B13/2-NA	132703	1/60
15	415	15	480Y/277	14	SWD		FAZ-B15/2-NA	132704	1/60
16	415	15	480Y/277	14	SWD		FAZ-B16/2-NA	132705	1/60
20	415	15	480Y/277	14	SWD		FAZ-B20/2-NA	132706	1/60
25	415	15	480Y/277	14			FAZ-B25/2-NA	132707	1/60
30	415	15	480Y/277	10			FAZ-B30/2-NA	132708	1/60
32	415	15	480Y/277	10			FAZ-B32/2-NA	132709	1/60
35	415	15	240	10			FAZ-B35/2-NA	132710	1/60
40	415	15	240	10			FAZ-B40/2-NA	132711	1/60

SG09211



3-pole

1	415	15	480Y/277	10	SWD	AWG 18	FAZ-B1/3-NA	132712	1/40
1,5	415	15	480Y/277	10	SWD	AWG 18	FAZ-B1,5/3-NA	132713	1/40
2	415	15	480Y/277	10	SWD	AWG 18	FAZ-B2/3-NA	132714	1/40
3	415	15	480Y/277	10	SWD	AWG 18	FAZ-B3/3-NA	132715	1/40
4	415	15	480Y/277	10	SWD	AWG 18	FAZ-B4/3-NA	132716	1/40
5	415	15	480Y/277	10	SWD	AWG 18	FAZ-B5/3-NA	132717	1/40
6	415	15	480Y/277	10	SWD	AWG 18	FAZ-B6/3-NA	132718	1/40
7	415	15	480Y/277	10	SWD	AWG 18	FAZ-B7/3-NA	132719	1/40
8	415	15	480Y/277	10	SWD	AWG 16	FAZ-B8/3-NA	132720	1/40
10	415	15	480Y/277	10	SWD	AWG 16	FAZ-B10/3-NA	132721	1/40
13	415	15	480Y/277	10	SWD		FAZ-B13/3-NA	132722	1/40
15	415	15	480Y/277	14	SWD		FAZ-B15/3-NA	132723	1/40
16	415	15	480Y/277	14	SWD		FAZ-B16/3-NA	132724	1/40
20	415	15	480Y/277	14	SWD		FAZ-B20/3-NA	132725	1/40
25	415	15	480Y/277	14			FAZ-B25/3-NA	132726	1/40
30	415	15	480Y/277	10			FAZ-B30/3-NA	132727	1/40
32	415	15	480Y/277	10			FAZ-B32/3-NA	132728	1/40
35	415	15	240	10			FAZ-B35/3-NA	132729	1/40
40	415	15	240	10			FAZ-B40/3-NA	132730	1/40

FAZ-...-NA | Characteristic C

FAZ-...-NA Miniature Circuit Breakers (MCBs)

Characteristic C

SG09011



Rated current I_n (A)	Rated voltage IEC/EN 60947-2 (V)	Breaking capacity acc. to IEC/EN 60947-2 (kA)	Rated voltage UL489 (V)	Breaking capacity acc. to UL489 (kA)	SWD	NFPA 79	Type Designation	Article No.	Units per package
----------------------------	---	---	-------------------------------	---	-----	---------	---------------------	-------------	-------------------------

1-pole

0,5	240/415	15	277	10	SWD	AWG 18	FAZ-C0,5/1-NA	102077	12/120
1	240/415	15	277	10	SWD	AWG 18	FAZ-C1/1-NA	102078	12/120
1,5	240/415	15	277	10	SWD	AWG 18	FAZ-C1,5/1-NA	102079	12/120
2	240/415	15	277	10	SWD	AWG 18	FAZ-C2/1-NA	102080	12/120
3	240/415	15	277	10	SWD	AWG 18	FAZ-C3/1-NA	102081	12/120
4	240/415	15	277	10	SWD	AWG 18	FAZ-C4/1-NA	102082	12/120
5	240/415	15	277	10	SWD	AWG 18	FAZ-C5/1-NA	102083	12/120
6	240/415	15	277	10	SWD	AWG 18	FAZ-C6/1-NA	102084	12/120
7	240/415	15	277	10	SWD	AWG 18	FAZ-C7/1-NA	102085	12/120
8	240/415	15	277	10	SWD	AWG 16	FAZ-C8/1-NA	102086	12/120
10	240/415	15	277	10	SWD	AWG 16	FAZ-C10/1-NA	102087	12/120
13	240/415	15	277	10	SWD		FAZ-C13/1-NA	102088	12/120
15	240/415	15	277	14	SWD		FAZ-C15/1-NA	102089	12/120
16	240/415	15	277	14	SWD		FAZ-C16/1-NA	102090	12/120
20	240/415	15	277	14	SWD		FAZ-C20/1-NA	102091	12/120
25	240/415	15	277	14			FAZ-C25/1-NA	102092	12/120
30	240/415	15	277	10			FAZ-C30/1-NA	102093	12/120
32	240/415	15	277	10			FAZ-C32/1-NA	102094	12/120
35	240/415	15	240	10			FAZ-C35/1-NA	102095	12/120
40	240/415	15	240	10			FAZ-C40/1-NA	102096	12/120

SG09111



2-pole

0,5	415	15	480Y/277	10	SWD	AWG 18	FAZ-C0,5/2-NA	102157	1/60
1	415	15	480Y/277	10	SWD	AWG 18	FAZ-C1/2-NA	102158	1/60
1,5	415	15	480Y/277	10	SWD	AWG 18	FAZ-C1,5/2-NA	102159	1/60
2	415	15	480Y/277	10	SWD	AWG 18	FAZ-C2/2-NA	102160	1/60
3	415	15	480Y/277	10	SWD	AWG 18	FAZ-C3/2-NA	102161	1/60
4	415	15	480Y/277	10	SWD	AWG 18	FAZ-C4/2-NA	102162	1/60
5	415	15	480Y/277	10	SWD	AWG 18	FAZ-C5/2-NA	102163	1/60
6	415	15	480Y/277	10	SWD	AWG 18	FAZ-C6/2-NA	102164	1/60
7	415	15	480Y/277	10	SWD	AWG 18	FAZ-C7/2-NA	102165	1/60
8	415	15	480Y/277	10	SWD	AWG 16	FAZ-C8/2-NA	102166	1/60
10	415	15	480Y/277	10	SWD	AWG 16	FAZ-C10/2-NA	102167	1/60
13	415	15	480Y/277	10	SWD		FAZ-C13/2-NA	102168	1/60
15	415	15	480Y/277	14	SWD		FAZ-C15/2-NA	102169	1/60
16	415	15	480Y/277	14	SWD		FAZ-C16/2-NA	102170	1/60
20	415	15	480Y/277	14	SWD		FAZ-C20/2-NA	102171	1/60
25	415	15	480Y/277	14			FAZ-C25/2-NA	102172	1/60
30	415	15	480Y/277	10			FAZ-C30/2-NA	102173	1/60
32	415	15	480Y/277	10			FAZ-C32/2-NA	102174	1/60
35	415	15	240	10			FAZ-C35/2-NA	102175	1/60
40	415	15	240	10			FAZ-C40/2-NA	102176	1/60

SG09211



3-pole

0,5	415	15	480Y/277	10	SWD	AWG 18	FAZ-C0,5/3-NA	102237	1/40
1	415	15	480Y/277	10	SWD	AWG 18	FAZ-C1/3-NA	102238	1/40
1,5	415	15	480Y/277	10	SWD	AWG 18	FAZ-C1,5/3-NA	102239	1/40
2	415	15	480Y/277	10	SWD	AWG 18	FAZ-C2/3-NA	102240	1/40
3	415	15	480Y/277	10	SWD	AWG 18	FAZ-C3/3-NA	102241	1/40
4	415	15	480Y/277	10	SWD	AWG 18	FAZ-C4/3-NA	102242	1/40
5	415	15	480Y/277	10	SWD	AWG 18	FAZ-C5/3-NA	102243	1/40
6	415	15	480Y/277	10	SWD	AWG 18	FAZ-C6/3-NA	102244	1/40
7	415	15	480Y/277	10	SWD	AWG 18	FAZ-C7/3-NA	102245	1/40
8	415	15	480Y/277	10	SWD	AWG 16	FAZ-C8/3-NA	102246	1/40
10	415	15	480Y/277	10	SWD	AWG 16	FAZ-C10/3-NA	102247	1/40
13	415	15	480Y/277	10	SWD		FAZ-C13/3-NA	102248	1/40
15	415	15	480Y/277	14	SWD		FAZ-C15/3-NA	102249	1/40
16	415	15	480Y/277	14	SWD		FAZ-C16/3-NA	102250	1/40
20	415	15	480Y/277	14	SWD		FAZ-C20/3-NA	102251	1/40
25	415	15	480Y/277	14			FAZ-C25/3-NA	102252	1/40
30	415	15	480Y/277	10			FAZ-C30/3-NA	102253	1/40
32	415	15	480Y/277	10			FAZ-C32/3-NA	102254	1/40
35	415	15	240	10			FAZ-C35/3-NA	102255	1/40
40	415	15	240	10			FAZ-C40/3-NA	102256	1/40

FAZ-...-NA | Characteristic D

FAZ-...-NA Miniature Circuit Breakers (MCBs)

Characteristic D

SG09011



Rated current I_n (A)	Rated voltage IEC/EN 60947-2 (V)	Breaking capacity acc. to IEC/EN 60947-2 (kA)	Rated voltage UL489 (V)	Breaking capacity acc. to UL489 (kA)	SWD	NFPA 79	Type Designation	Article No.	Units per package
-------------------------	----------------------------------	---	-------------------------	--------------------------------------	-----	---------	------------------	-------------	-------------------

1-pole

0,5	240/415	15	277	10	SWD	AWG 18	FAZ-D0,5/1-NA	102097	12/120
1	240/415	15	277	10	SWD	AWG 18	FAZ-D1/1-NA	102098	12/120
1,5	240/415	15	277	10	SWD	AWG 18	FAZ-D1,5/1-NA	102099	12/120
2	240/415	15	277	10	SWD	AWG 18	FAZ-D2/1-NA	102100	12/120
3	240/415	15	277	10	SWD	AWG 18	FAZ-D3/1-NA	102101	12/120
4	240/415	15	277	10	SWD	AWG 18	FAZ-D4/1-NA	102102	12/120
5	240/415	15	277	10	SWD	AWG 18	FAZ-D5/1-NA	102103	12/120
6	240/415	15	277	10	SWD	AWG 18	FAZ-D6/1-NA	102104	12/120
7	240/415	15	277	10	SWD	AWG 18	FAZ-D7/1-NA	102105	12/120
8	240/415	15	277	10	SWD	AWG 16	FAZ-D8/1-NA	102106	12/120
10	240/415	15	277	10	SWD	AWG 16	FAZ-D10/1-NA	102107	12/120
13	240/415	15	277	14	SWD		FAZ-D13/1-NA	102108	12/120
15	240/415	15	277	14	SWD		FAZ-D15/1-NA	102109	12/120
16	240/415	15	277	14	SWD		FAZ-D16/1-NA	102110	12/120
20	240/415	15	277	14	SWD		FAZ-D20/1-NA	102111	12/120
25	240/415	15	277	10			FAZ-D25/1-NA	102112	12/120
30	240/415	15	277	10			FAZ-D30/1-NA	102113	12/120
32	240/415	15	277	10			FAZ-D32/1-NA	102114	12/120
35	240/415	15	240	10			FAZ-D35/1-NA	102115	12/120
40	240/415	15	240	10			FAZ-D40/1-NA	102116	12/120

SG09111



2-pole

0,5	415	15	480Y/277	10	SWD	AWG 18	FAZ-D0,5/2-NA	102177	1/60
1	415	15	480Y/277	10	SWD	AWG 18	FAZ-D1/2-NA	102178	1/60
1,5	415	15	480Y/277	10	SWD	AWG 18	FAZ-D1,5/2-NA	102179	1/60
2	415	15	480Y/277	10	SWD	AWG 18	FAZ-D2/2-NA	102180	1/60
3	415	15	480Y/277	10	SWD	AWG 18	FAZ-D3/2-NA	102181	1/60
4	415	15	480Y/277	10	SWD	AWG 18	FAZ-D4/2-NA	102182	1/60
5	415	15	480Y/277	10	SWD	AWG 18	FAZ-D5/2-NA	102183	1/60
6	415	15	480Y/277	10	SWD	AWG 18	FAZ-D6/2-NA	102184	1/60
7	415	15	480Y/277	10	SWD	AWG 18	FAZ-D7/2-NA	102185	1/60
8	415	15	480Y/277	10	SWD	AWG 16	FAZ-D8/2-NA	102186	1/60
10	415	15	480Y/277	10	SWD	AWG 16	FAZ-D10/2-NA	102187	1/60
13	415	15	480Y/277	14	SWD		FAZ-D13/2-NA	102188	1/60
15	415	15	480Y/277	14	SWD		FAZ-D15/2-NA	102189	1/60
16	415	15	480Y/277	14	SWD		FAZ-D16/2-NA	102190	1/60
20	415	15	480Y/277	14	SWD		FAZ-D20/2-NA	102191	1/60
25	415	15	480Y/277	10			FAZ-D25/2-NA	102192	1/60
30	415	15	480Y/277	10			FAZ-D30/2-NA	102193	1/60
32	415	15	480Y/277	10			FAZ-D32/2-NA	102194	1/60
35	415	15	240	10			FAZ-D35/2-NA	102195	1/60
40	415	15	240	10			FAZ-D40/2-NA	102196	1/60

SG09211



3-pole

0,5	415	15	480Y/277	10	SWD	AWG 18	FAZ-D0,5/3-NA	102257	1/40
1	415	15	480Y/277	10	SWD	AWG 18	FAZ-D1/3-NA	102258	1/40
1,5	415	15	480Y/277	10	SWD	AWG 18	FAZ-D1,5/3-NA	102259	1/40
2	415	15	480Y/277	10	SWD	AWG 18	FAZ-D2/3-NA	102260	1/40
3	415	15	480Y/277	10	SWD	AWG 18	FAZ-D3/3-NA	102261	1/40
4	415	15	480Y/277	10	SWD	AWG 18	FAZ-D4/3-NA	102262	1/40
5	415	15	480Y/277	10	SWD	AWG 18	FAZ-D5/3-NA	102263	1/40
6	415	15	480Y/277	10	SWD	AWG 18	FAZ-D6/3-NA	102264	1/40
7	415	15	480Y/277	10	SWD	AWG 18	FAZ-D7/3-NA	102265	1/40
8	415	15	480Y/277	10	SWD	AWG 16	FAZ-D8/3-NA	102266	1/40
10	415	15	480Y/277	10	SWD	AWG 16	FAZ-D10/3-NA	102267	1/40
13	415	15	480Y/277	14	SWD		FAZ-D13/3-NA	102268	1/40
15	415	15	480Y/277	14	SWD		FAZ-D15/3-NA	102269	1/40
16	415	15	480Y/277	14	SWD		FAZ-D16/3-NA	102270	1/40
20	415	15	480Y/277	14	SWD		FAZ-D20/3-NA	102271	1/40
25	415	15	480Y/277	10			FAZ-D25/3-NA	102272	1/40
30	415	15	480Y/277	10			FAZ-D30/3-NA	102273	1/40
32	415	15	480Y/277	10			FAZ-D32/3-NA	102274	1/40
35	415	15	240	10			FAZ-D35/3-NA	102275	1/40
40	415	15	240	10			FAZ-D40/3-NA	102276	1/40

FAZ-...-NA-DC | Characteristic C

FAZ-...-NA-DC Miniature Circuit Breakers (MCBs) Characteristic C

Rated current I_n (A)	Rated voltage IEC/EN 60947-2 (V DC)	Breaking capacity acc. to IEC/EN 60947-2 (kA)	Rated voltage UL489 (V)	Breaking capacity acc. to UL489 (kA)	SWD	NFPA 79	Type Designation	Article No.	Units per package
----------------------------	--	---	-------------------------------	---	-----	---------	---------------------	-------------	-------------------------

SG09011



1-pole

2	220	10	125	10			FAZ-C2/1-NA-DC	113752	12/120
3	250	10	125	10			FAZ-C3/1-NA-DC	113753	12/120
4	250	10	125	10			FAZ-C4/1-NA-DC	113754	12/120
5	250	10	125	10			FAZ-C5/1-NA-DC	113755	12/120
6	250	10	125	10			FAZ-C6/1-NA-DC	113756	12/120
7	250	10	125	10			FAZ-C7/1-NA-DC	113757	12/120
8	250	10	125	10			FAZ-C8/1-NA-DC	113758	12/120
10	250	10	125	10			FAZ-C10/1-NA-DC	113759	12/120
13	250	10	125	10			FAZ-C13/1-NA-DC	113760	12/120
15	250	10	125	10			FAZ-C15/1-NA-DC	113761	12/120
16	250	10	125	10			FAZ-C16/1-NA-DC	113762	12/120
20	250	10	125	10			FAZ-C20/1-NA-DC	113763	12/120
25	250	10	125	10			FAZ-C25/1-NA-DC	113764	12/120
30	250	10	125	10			FAZ-C30/1-NA-DC	113765	12/120
32	250	10	125	10			FAZ-C32/1-NA-DC	113766	12/120
35	250	10	125	10			FAZ-C35/1-NA-DC	113767	12/120
40	250	10	125	10			FAZ-C40/1-NA-DC	113768	12/120

SG09111



2-pole

2	440	10	250	10			FAZ-C2/2-NA-DC	137239	1/60
3	500	10	250	10			FAZ-C3/2-NA-DC	137250	1/60
4	500	10	250	10			FAZ-C4/2-NA-DC	137251	1/60
5	500	10	250	10			FAZ-C5/2-NA-DC	137252	1/60
6	500	10	250	10			FAZ-C6/2-NA-DC	120638	1/60
7	500	10	250	10			FAZ-C7/2-NA-DC	120639	1/60
8	500	10	250	10			FAZ-C8/2-NA-DC	120640	1/60
10	500	10	250	10			FAZ-C10/2-NA-DC	120641	1/60
13	500	10	250	10			FAZ-C13/2-NA-DC	120642	1/60
15	500	10	250	10			FAZ-C15/2-NA-DC	120643	1/60
16	500	10	250	10			FAZ-C16/2-NA-DC	120644	1/60
20	500	10	250	10			FAZ-C20/2-NA-DC	120645	1/60
25	500	10	250	10			FAZ-C25/2-NA-DC	120646	1/60
30	500	10	250	10			FAZ-C30/2-NA-DC	120647	1/60
32	500	10	250	10			FAZ-C32/2-NA-DC	120648	1/60
35	500	10	250	10			FAZ-C35/2-NA-DC	120649	1/60
40	500	10	250	10			FAZ-C40/2-NA-DC	120650	1/60

FAZ-...-NA-DC | Specifications

Specifications

Technical data

		FAZ-NA-DC
Productstandard		UL 489, CSA C22.2 No 5-02
Number of poles		1, 2
Mechanical specifications		
Device width		1 pole = 0.697 inch, 2 poles = 1.394 inch
Frame size		1.772 inch
Socket size		4.134 inch
Device depth		2.362 inch
Terminals		lift terminal / ring-tongue
Terminal capacity rigid solid/stranded wire		1 Wire: AWG 18-6 (Cu only) 2 Wires: AWG 18-10 (Cu only)
Terminal screw		M5 (with slotted screw Pozidriv PZ2)
Terminal torque		#18-12 AWG: 21 lb-in #10-8 AWG: 25 lb-in #6 AWG: 36 lb-in
Snap on fixing		tristable (on DIN Rail acc. to IEC/EN 60715)
Finger proof		acc.to VBG4, ÖVE EN-6
Contact position indicator		red / green
Electrical specifications		
Rated voltage DC	U_n	125 V d.c. (1p) 250 V d.c. (2p)
Rated current	I_n	6, 7, 8, 10, 13, 15, 16, 20, 25, 30, 32, 35, 40 A
Rated impulse withstand voltage	U_{imp}	4 kV (1.2/50) μ sec
Tripping characteristic		
Conventional non-tripping current	I_{nt}	$I_{nt}=1.0 I_n$
Conventional tripping current	I_t	$I_t=1.35 I_n$
Reference temperature		40 °C
Temperature factor		0.5% /K
Instantaneous tripping current	I_{mt}	$7 I_n < I_{mt} = 15 I_n \cdot t (I_{mt}) < 0,1 \text{ sec}$
Current interrupting rating		10 kA
Number of electrical operating cycles		6000
Number of mechanical operating cycles		10000
Climatic conditions		acc. to IEC 68-2 (25..55°C / 90..95% RH)

Connection diagrams

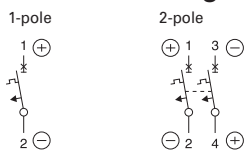

FAZ-...-NA-DC | Specifications

Dimensions (mm) FAZ-NA-DC

1-pole

2-pole

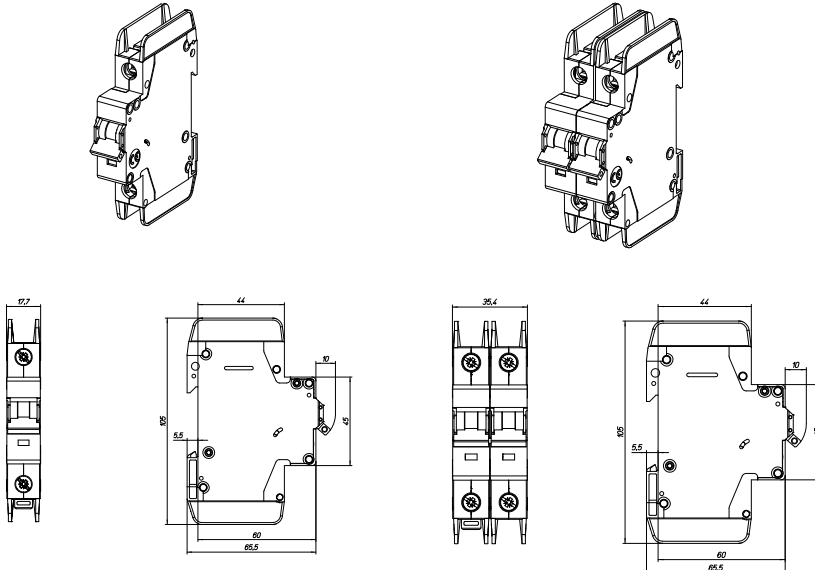

Tripping Characteristic FAZ-NA-DC

Characteristics C - UL 489

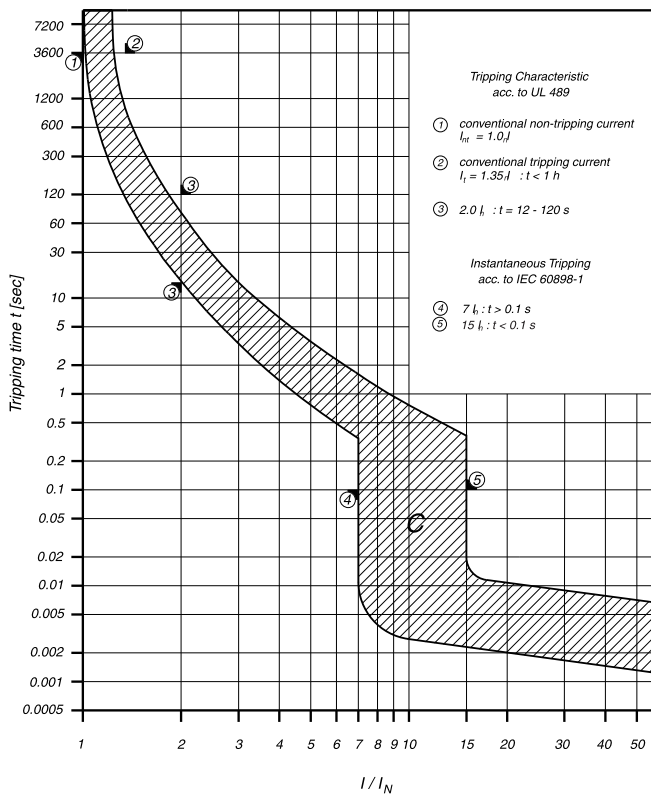

FAZ-...-RT | Characteristic B

FAZ-...-RT Miniature Circuit Breakers (MCBs)

Characteristic B

SG09011



Rated current I_n (A)	Rated voltage IEC/EN 60947-2 (V)	Breaking capacity acc. to IEC/EN 60947-2 (kA)	Rated voltage UL489 (V)	Breaking capacity acc. to UL489 (kA)	SWD	NFPA 79	Type Designation	Article No.	Units per package
----------------------------	---	---	-------------------------------	---	-----	---------	---------------------	-------------	-------------------------

1-pole

1	240/415	15	277	10	SWD	AWG 18	FAZ-B1/1-RT	132731	12/120
1,5	240/415	15	277	10	SWD	AWG 18	FAZ-B1,5/1-RT	132732	12/120
2	240/415	15	277	10	SWD	AWG 18	FAZ-B2/1-RT	132733	12/120
3	240/415	15	277	10	SWD	AWG 18	FAZ-B3/1-RT	132734	12/120
4	240/415	15	277	10	SWD	AWG 18	FAZ-B4/1-RT	132735	12/120
5	240/415	15	277	10	SWD	AWG 18	FAZ-B5/1-RT	132736	12/120
6	240/415	15	277	10	SWD	AWG 18	FAZ-B6/1-RT	132737	12/120
7	240/415	15	277	10	SWD	AWG 18	FAZ-B7/1-RT	132738	12/120
8	240/415	15	277	10	SWD	AWG 16	FAZ-B8/1-RT	132739	12/120
10	240/415	15	277	10	SWD	AWG 16	FAZ-B10/1-RT	132740	12/120
13	240/415	15	277	10	SWD		FAZ-B13/1-RT	132741	12/120
15	240/415	15	277	14	SWD		FAZ-B15/1-RT	132742	12/120
16	240/415	15	277	14	SWD		FAZ-B16/1-RT	132743	12/120
20	240/415	15	277	14	SWD		FAZ-B20/1-RT	132744	12/120
25	240/415	15	277	14			FAZ-B25/1-RT	132745	12/120
30	240/415	15	277	10			FAZ-B30/1-RT	132746	12/120
32	240/415	15	277	10			FAZ-B32/1-RT	132747	12/120
35	240/415	15	240	10			FAZ-B35/1-RT	132748	12/120
40	240/415	15	240	10			FAZ-B40/1-RT	132749	12/120

SG09111



2-pole

1	415	15	480Y/277	10	SWD	AWG 18	FAZ-B1/2-RT	132750	1/60
1,5	415	15	480Y/277	10	SWD	AWG 18	FAZ-B1,5/2-RT	132751	1/60
2	415	15	480Y/277	10	SWD	AWG 18	FAZ-B2/2-RT	132752	1/60
3	415	15	480Y/277	10	SWD	AWG 18	FAZ-B3/2-RT	132753	1/60
4	415	15	480Y/277	10	SWD	AWG 18	FAZ-B4/2-RT	132754	1/60
5	415	15	480Y/277	10	SWD	AWG 18	FAZ-B5/2-RT	132755	1/60
6	415	15	480Y/277	10	SWD	AWG 18	FAZ-B6/2-RT	132756	1/60
7	415	15	480Y/277	10	SWD	AWG 18	FAZ-B7/2-RT	132757	1/60
8	415	15	480Y/277	10	SWD	AWG 16	FAZ-B8/2-RT	132758	1/60
10	415	15	480Y/277	10	SWD	AWG 16	FAZ-B10/2-RT	132759	1/60
13	415	15	480Y/277	10	SWD		FAZ-B13/2-RT	132760	1/60
15	415	15	480Y/277	14	SWD		FAZ-B15/2-RT	132761	1/60
16	415	15	480Y/277	14	SWD		FAZ-B16/2-RT	132762	1/60
20	415	15	480Y/277	14	SWD		FAZ-B20/2-RT	132763	1/60
25	415	15	480Y/277	14			FAZ-B25/2-RT	132764	1/60
30	415	15	480Y/277	10			FAZ-B30/2-RT	132765	1/60
32	415	15	480Y/277	10			FAZ-B32/2-RT	132766	1/60
35	415	15	240	10			FAZ-B35/2-RT	132767	1/60
40	415	15	240	10			FAZ-B40/2-RT	132768	1/60

SG09211



3-pole

1	415	15	480Y/277	10	SWD	AWG 18	FAZ-B1/3-RT	132769	1/40
1,5	415	15	480Y/277	10	SWD	AWG 18	FAZ-B1,5/3-RT	132770	1/40
2	415	15	480Y/277	10	SWD	AWG 18	FAZ-B2/3-RT	132771	1/40
3	415	15	480Y/277	10	SWD	AWG 18	FAZ-B3/3-RT	132772	1/40
4	415	15	480Y/277	10	SWD	AWG 18	FAZ-B4/3-RT	132773	1/40
5	415	15	480Y/277	10	SWD	AWG 18	FAZ-B5/3-RT	132774	1/40
6	415	15	480Y/277	10	SWD	AWG 18	FAZ-B6/3-RT	132775	1/40
7	415	15	480Y/277	10	SWD	AWG 18	FAZ-B7/3-RT	132776	1/40
8	415	15	480Y/277	10	SWD	AWG 16	FAZ-B8/3-RT	132777	1/40
10	415	15	480Y/277	10	SWD	AWG 16	FAZ-B10/3-RT	132778	1/40
13	415	15	480Y/277	10	SWD		FAZ-B13/3-RT	132779	1/40
15	415	15	480Y/277	14	SWD		FAZ-B15/3-RT	132780	1/40
16	415	15	480Y/277	14	SWD		FAZ-B16/3-RT	132781	1/40
20	415	15	480Y/277	14	SWD		FAZ-B20/3-RT	132782	1/40
25	415	15	480Y/277	14			FAZ-B25/3-RT	132783	1/40
30	415	15	480Y/277	10			FAZ-B30/3-RT	132784	1/40
32	415	15	480Y/277	10			FAZ-B32/3-RT	132785	1/40
35	415	15	240	10			FAZ-B35/3-RT	132786	1/40
40	415	15	240	10			FAZ-B40/3-RT	132787	1/40

FAZ-...-RT | Characteristic C

FAZ-...-RT Miniature Circuit Breakers (MCBs)

Characteristic C

SG09011



Rated current I_n (A)	Rated voltage IEC/EN 60947-2 (V)	Breaking capacity acc. to IEC/EN 60947-2 (kA)	Rated voltage UL489 (V)	Breaking capacity acc. to UL489 (kA)	SWD	NFPA 79	Type Designation	Article No.	Units per package
----------------------------	---	---	-------------------------------	---	-----	---------	---------------------	-------------	-------------------------

1-pole

0,5	240/415	15	277	10	SWD	AWG 18	FAZ-C0,5/1-RT	102117	12/120
1	240/415	15	277	10	SWD	AWG 18	FAZ-C1/1-RT	102118	12/120
1,5	240/415	15	277	10	SWD	AWG 18	FAZ-C1,5/1-RT	102119	12/120
2	240/415	15	277	10	SWD	AWG 18	FAZ-C2/1-RT	102120	12/120
3	240/415	15	277	10	SWD	AWG 18	FAZ-C3/1-RT	102121	12/120
4	240/415	15	277	10	SWD	AWG 18	FAZ-C4/1-RT	102122	12/120
5	240/415	15	277	10	SWD	AWG 18	FAZ-C5/1-RT	102123	12/120
6	240/415	15	277	10	SWD	AWG 18	FAZ-C6/1-RT	102124	12/120
7	240/415	15	277	10	SWD	AWG 18	FAZ-C7/1-RT	102125	12/120
8	240/415	15	277	10	SWD	AWG 16	FAZ-C8/1-RT	102126	12/120
10	240/415	15	277	10	SWD	AWG 16	FAZ-C10/1-RT	102127	12/120
13	240/415	15	277	10	SWD		FAZ-C13/1-RT	102128	12/120
15	240/415	15	277	14	SWD		FAZ-C15/1-RT	102129	12/120
16	240/415	15	277	14	SWD		FAZ-C16/1-RT	102130	12/120
20	240/415	15	277	14	SWD		FAZ-C20/1-RT	102131	12/120
25	240/415	15	277	14			FAZ-C25/1-RT	102132	12/120
30	240/415	15	277	10			FAZ-C30/1-RT	102133	12/120
32	240/415	15	277	10			FAZ-C32/1-RT	102134	12/120
35	240/415	15	240	10			FAZ-C35/1-RT	102135	12/120
40	240/415	15	240	10			FAZ-C40/1-RT	102136	12/120

SG09111



2-pole

0,5	415	15	480Y/277	10	SWD	AWG 18	FAZ-C0,5/2-RT	102197	1/60
1	415	15	480Y/277	10	SWD	AWG 18	FAZ-C1/2-RT	102198	1/60
1,5	415	15	480Y/277	10	SWD	AWG 18	FAZ-C1,5/2-RT	102199	1/60
2	415	15	480Y/277	10	SWD	AWG 18	FAZ-C2/2-RT	102200	1/60
3	415	15	480Y/277	10	SWD	AWG 18	FAZ-C3/2-RT	102201	1/60
4	415	15	480Y/277	10	SWD	AWG 18	FAZ-C4/2-RT	102202	1/60
5	415	15	480Y/277	10	SWD	AWG 18	FAZ-C5/2-RT	102203	1/60
6	415	15	480Y/277	10	SWD	AWG 18	FAZ-C6/2-RT	102204	1/60
7	415	15	480Y/277	10	SWD	AWG 18	FAZ-C7/2-RT	102205	1/60
8	415	15	480Y/277	10	SWD	AWG 16	FAZ-C8/2-RT	102206	1/60
10	415	15	480Y/277	10	SWD	AWG 16	FAZ-C10/2-RT	102207	1/60
13	415	15	480Y/277	10	SWD		FAZ-C13/2-RT	102208	1/60
15	415	15	480Y/277	14	SWD		FAZ-C15/2-RT	102209	1/60
16	415	15	480Y/277	14	SWD		FAZ-C16/2-RT	102210	1/60
20	415	15	480Y/277	14	SWD		FAZ-C20/2-RT	102211	1/60
25	415	15	480Y/277	14			FAZ-C25/2-RT	102212	1/60
30	415	15	480Y/277	10			FAZ-C30/2-RT	102213	1/60
32	415	15	480Y/277	10			FAZ-C32/2-RT	102214	1/60
35	415	15	240	10			FAZ-C35/2-RT	102215	1/60
40	415	15	240	10			FAZ-C40/2-RT	102216	1/60

SG09211



3-pole

0,5	415	15	480Y/277	10	SWD	AWG 18	FAZ-C0,5/3-RT	102277	1/40
1	415	15	480Y/277	10	SWD	AWG 18	FAZ-C1/3-RT	102278	1/40
1,5	415	15	480Y/277	10	SWD	AWG 18	FAZ-C1,5/3-RT	102279	1/40
2	415	15	480Y/277	10	SWD	AWG 18	FAZ-C2/3-RT	102280	1/40
3	415	15	480Y/277	10	SWD	AWG 18	FAZ-C3/3-RT	102281	1/40
4	415	15	480Y/277	10	SWD	AWG 18	FAZ-C4/3-RT	102282	1/40
5	415	15	480Y/277	10	SWD	AWG 18	FAZ-C5/3-RT	102283	1/40
6	415	15	480Y/277	10	SWD	AWG 18	FAZ-C6/3-RT	102284	1/40
7	415	15	480Y/277	10	SWD	AWG 18	FAZ-C7/3-RT	102285	1/40
8	415	15	480Y/277	10	SWD	AWG 16	FAZ-C8/3-RT	102286	1/40
10	415	15	480Y/277	10	SWD	AWG 16	FAZ-C10/3-RT	102287	1/40
13	415	15	480Y/277	10	SWD		FAZ-C13/3-RT	102288	1/40
15	415	15	480Y/277	14	SWD		FAZ-C15/3-RT	102289	1/40
16	415	15	480Y/277	14	SWD		FAZ-C16/3-RT	102290	1/40
20	415	15	480Y/277	14	SWD		FAZ-C20/3-RT	102291	1/40
25	415	15	480Y/277	14			FAZ-C25/3-RT	102292	1/40
30	415	15	480Y/277	10			FAZ-C30/3-RT	102293	1/40
32	415	15	480Y/277	10			FAZ-C32/3-RT	102294	1/40
35	415	15	240	10			FAZ-C35/3-RT	102295	1/40
40	415	15	240	10			FAZ-C40/3-RT	102296	1/40

FAZ-...-RT | Characteristic D

FAZ-...-RT Miniature Circuit Breakers (MCBs)

Characteristic D

SG09011



Rated current I_n (A)	Rated voltage IEC/EN 60947-2 (V)	Breaking capacity acc. to IEC/EN 60947-2 (kA)	Rated voltage UL489 (V)	Breaking capacity acc. to UL489 (kA)	SWD	NFPA 79	Type Designation	Article No.	Units per package
-------------------------	----------------------------------	---	-------------------------	--------------------------------------	-----	---------	------------------	-------------	-------------------

1-pole

0,5	240/415	15	277	10	SWD	AWG 18	FAZ-D0,5/1-RT	102137	12/120
1	240/415	15	277	10	SWD	AWG 18	FAZ-D1/1-RT	102138	12/120
1,5	240/415	15	277	10	SWD	AWG 18	FAZ-D1,5/1-RT	102139	12/120
2	240/415	15	277	10	SWD	AWG 18	FAZ-D2/1-RT	102140	12/120
3	240/415	15	277	10	SWD	AWG 18	FAZ-D3/1-RT	102141	12/120
4	240/415	15	277	10	SWD	AWG 18	FAZ-D4/1-RT	102142	12/120
5	240/415	15	277	10	SWD	AWG 18	FAZ-D5/1-RT	102143	12/120
6	240/415	15	277	10	SWD	AWG 18	FAZ-D6/1-RT	102144	12/120
7	240/415	15	277	10	SWD	AWG 18	FAZ-D7/1-RT	102145	12/120
8	240/415	15	277	10	SWD	AWG 16	FAZ-D8/1-RT	102146	12/120
10	240/415	15	277	10	SWD	AWG 16	FAZ-D10/1-RT	102147	12/120
13	240/415	15	277	14	SWD		FAZ-D13/1-RT	102148	12/120
15	240/415	15	277	14	SWD		FAZ-D15/1-RT	102149	12/120
16	240/415	15	277	14	SWD		FAZ-D16/1-RT	102150	12/120
20	240/415	15	277	14	SWD		FAZ-D20/1-RT	102151	12/120
25	240/415	15	277	10			FAZ-D25/1-RT	102152	12/120
30	240/415	15	277	10			FAZ-D30/1-RT	102153	12/120
32	240/415	15	277	10			FAZ-D32/1-RT	102154	12/120
35	240/415	15	240	10			FAZ-D35/1-RT	102155	12/120
40	240/415	15	240	10			FAZ-D40/1-RT	102156	12/120

SG09111



2-pole

0,5	415	15	480Y/277	10	SWD	AWG 18	FAZ-D0,5/2-RT	102217	1/60
1	415	15	480Y/277	10	SWD	AWG 18	FAZ-D1/2-RT	102218	1/60
1,5	415	15	480Y/277	10	SWD	AWG 18	FAZ-D1,5/2-RT	102219	1/60
2	415	15	480Y/277	10	SWD	AWG 18	FAZ-D2/2-RT	102220	1/60
3	415	15	480Y/277	10	SWD	AWG 18	FAZ-D3/2-RT	102221	1/60
4	415	15	480Y/277	10	SWD	AWG 18	FAZ-D4/2-RT	102222	1/60
5	415	15	480Y/277	10	SWD	AWG 18	FAZ-D5/2-RT	102223	1/60
6	415	15	480Y/277	10	SWD	AWG 18	FAZ-D6/2-RT	102224	1/60
7	415	15	480Y/277	10	SWD	AWG 18	FAZ-D7/2-RT	102225	1/60
8	415	15	480Y/277	10	SWD	AWG 16	FAZ-D8/2-RT	102226	1/60
10	415	15	480Y/277	10	SWD	AWG 16	FAZ-D10/2-RT	102227	1/60
13	415	15	480Y/277	14	SWD		FAZ-D13/2-RT	102228	1/60
15	415	15	480Y/277	14	SWD		FAZ-D15/2-RT	102229	1/60
16	415	15	480Y/277	14	SWD		FAZ-D16/2-RT	102230	1/60
20	415	15	480Y/277	14	SWD		FAZ-D20/2-RT	102231	1/60
25	415	15	480Y/277	10			FAZ-D25/2-RT	102232	1/60
30	415	15	480Y/277	10			FAZ-D30/2-RT	102233	1/60
32	415	15	480Y/277	10			FAZ-D32/2-RT	102234	1/60
35	415	15	240	10			FAZ-D35/2-RT	102235	1/60
40	415	15	240	10			FAZ-D40/2-RT	102236	1/60

SG09211



3-pole

0,5	415	15	480Y/277	10	SWD	AWG 18	FAZ-D0,5/3-RT	102297	1/40
1	415	15	480Y/277	10	SWD	AWG 18	FAZ-D1/3-RT	102298	1/40
1,5	415	15	480Y/277	10	SWD	AWG 18	FAZ-D1,5/3-RT	102299	1/40
2	415	15	480Y/277	10	SWD	AWG 18	FAZ-D2/3-RT	102300	1/40
3	415	15	480Y/277	10	SWD	AWG 18	FAZ-D3/3-RT	102301	1/40
4	415	15	480Y/277	10	SWD	AWG 18	FAZ-D4/3-RT	102302	1/40
5	415	15	480Y/277	10	SWD	AWG 18	FAZ-D5/3-RT	102303	1/40
6	415	15	480Y/277	10	SWD	AWG 18	FAZ-D6/3-RT	102304	1/40
7	415	15	480Y/277	10	SWD	AWG 18	FAZ-D7/3-RT	102305	1/40
8	415	15	480Y/277	10	SWD	AWG 16	FAZ-D8/3-RT	102306	1/40
10	415	15	480Y/277	10	SWD	AWG 16	FAZ-D10/3-RT	102307	1/40
13	415	15	480Y/277	14	SWD		FAZ-D13/3-RT	102308	1/40
15	415	15	480Y/277	14	SWD		FAZ-D15/3-RT	102309	1/40
16	415	15	480Y/277	14	SWD		FAZ-D16/3-RT	102310	1/40
20	415	15	480Y/277	14	SWD		FAZ-D20/3-RT	102311	1/40
25	415	15	480Y/277	10			FAZ-D25/3-RT	102312	1/40
30	415	15	480Y/277	10			FAZ-D30/3-RT	102313	1/40
32	415	15	480Y/277	10			FAZ-D32/3-RT	102314	1/40
35	415	15	240	10			FAZ-D35/3-RT	102315	1/40
40	415	15	240	10			FAZ-D40/3-RT	102316	1/40

FAZ-...-NA, -RT | Specifications IEC/EN

Specifications

Technical data IEC/EN

		FAZ-...-NA, -RT
Productstandard		IEC/EN 60947-2
Number of poles		1, 2, 3
Mechanical specifications		
Device width		17.7mm (1-pole), 35.4 mm (2-poles), 53.1 mm (3-poles)
Frame size		45 mm
Socket size		105 mm
Device depth		60 mm
Terminals		lift terminal / ring-tongue
Terminal capacity rigid solid/stranded wire		1-25 mm ²
Terminal screw		M5 (with slotted screw Pozidriv PZ2)
Terminal torque		max. 2.4 Nm
Snap on fixing		tristable (on DIN Rail acc. to IEC/EN 60715)
Degree of Protection (DIN VDE 0470)		
Surface mounted		IP 20
Built-in behind panel		IP 40
Contact position indicator		red / green
Electrical specifications		
Rated voltage	U_n	240/415 V AC
Rated current	I_n	0.5, 1, 1.5, 2, 3, 4, 5, 6, 7, 8, 10, 13, 15, 16, 20, 25, 30, 32, 35, 40 A
Rated insulation voltage	U_i	440 V AC
Rated impulse withstand voltage	U_{imp}	4 kV (1.2/50)μsec
Tripping characteristic		
Conventional non-tripping current		$I_{nt}=1.05 I_n$
Conventional tripping current		$I_t=1.30 I_n$
Reference temperature		30 °C
Temperature factor		0.5% /K
Instantaneous tripping current	I_{mt}	type B: $3 I_n < I_{mt} = 5 I_n ; t (I_{mt}) < 0,1 \text{ sec}$ (IEC/EN 60898-1) type C: $5 I_n < I_{mt} = 10 I_n ; t (I_{mt}) < 0,1 \text{ sec}$ (IEC/EN 60898-1) type D: $10 I_n < I_{mt} = 20 I_n ; t (I_{mt}) < 0,1 \text{ sec}$ (IEC/EN 60898-1)
Rated short-circuit braking capacity	I_{cu}	15 kA
Service short circuit capacity	I_{cs}	7.5 kA
Selectivity class		3 (acc. to EN 60898)
Number of electrical operations		> 1500
Number of mechanical operations		> 10000
Climatic conditions		acc. to IEC 68-2 (25..55°C / 90..95% RH)

Connection diagrams

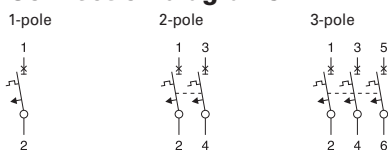

FAZ-...-NA, -RT | Specifications UL

Specifications

Technical data UL

		FAZ-...-NA, -RT
Productstandard		UL 489 CSA C22.2 No. 5-02
Number of poles		1, 2, 3
Mechanical specifications		
Device width		0.697 in. (1-pole), 1.394 in. (2-poles), 2.090 in. (3-poles)
Frame size		1.772 in.
Socket size		4.134 in.
Device depth		2.362 in.
Terminals		lift terminal / ring-tongue
Terminal capacity		1 Wire: #18-6 AWG (Cu only) 2 Wires: #18-10 AWG (Cu only)
Terminal screw		M5 (with slotted screw Pozidriv PZ2)
Terminal torque		#18-12 AWG: 21 lb-in #10-8 AWG: 25 lb-in #6 AWG: 36 lb-in
Snap on fixing		tristable (on DIN Rail acc. to IEC/EN 60715)
Contact position indicator		red / green
Electrical specifications		
Rated voltage	U_n	0.5-32 A: 480Y/277 V AC, 35-40 A: 240 V AC
Rated current	I_n	0.5, 1, 1.5, 2, 3, 4, 5, 6, 7, 8, 10, 13, 15, 16, 20, 25, 30, 32, 35, 40 A
Tripping characteristic		
Conventional non-tripping current		$I_{nt}=1.00 I_n$
Conventional tripping current		$I_t=1.35 I_n$
Reference temperature		40 °C
Temperature factor		0.5% /K
Instantaneous tripping current	I_{mt}	type C: $5 I_n < I_{mt} = 10 I_n$; $t(I_{mt}) < 0,1$ sec type D: $10 I_n < I_{mt} = 20 I_n$; $t(I_{mt}) < 0,1$ sec
Current interrupting rating		10 kA, 14 kA (types D13, B/C/D15, 16, 20, B/C25 A)
Current-Limiting at 240 V / 10 kA		1p, 2p, 3p to $I^2t = 43 \text{ kA}^2\text{s}$ and $I_{peak} = 6.2 \text{ kA}$
Current-Limiting at 480Y/277 V / 10 kA		1p, 2p, 3p to $I^2t = 60 \text{ kA}^2\text{s}$ and $I_{peak} = 6.2 \text{ kA}$
Current-Limiting at 480Y/277 V / 14 kA		1p, 2p, 3p to $I^2t = 65 \text{ kA}^2\text{s}$ and $I_{peak} = 7.5 \text{ kA}$
Selectivity class		3 (acc. to EN 60898)
Number of electrical operations		6000
Number of mechanical operations		10000
Climatic conditions		acc. to IEC 68-2 (25..55°C / 90..95% RH)

Connection diagrams

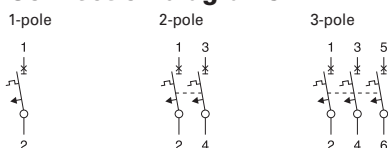

FAZ-...-NA, -RT | Specifications

Dimensions (mm) FAZ-...-NA, -RT

1-pole

2-pole

3-pole

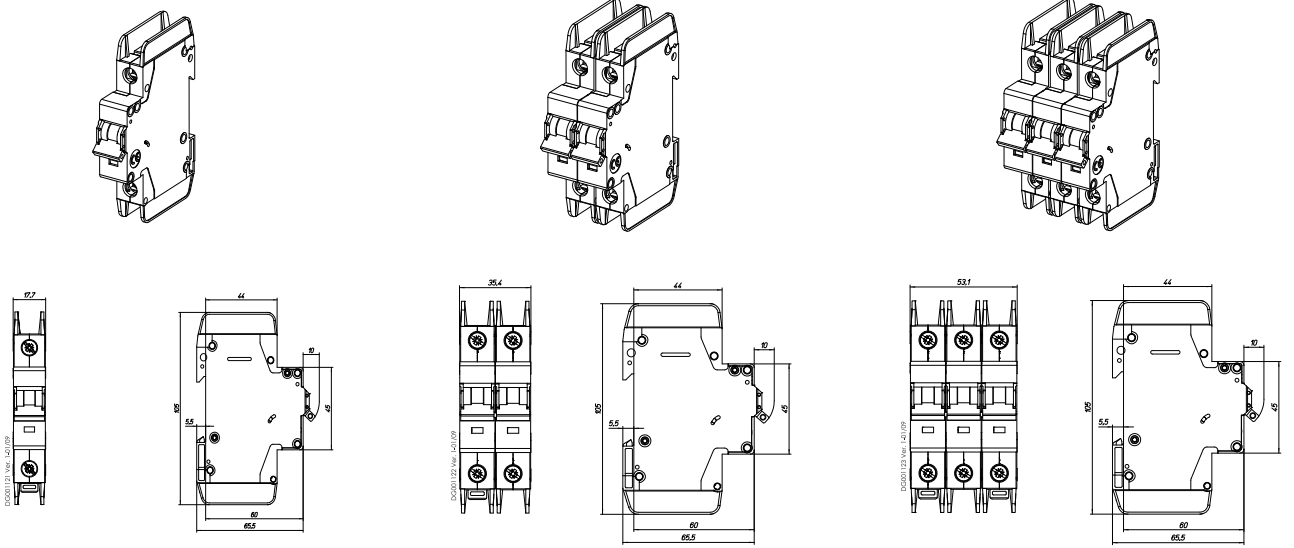

Tripping Characteristic FAZ-...-NA, -RT

Characteristics C and D - EN/IEC 60947-2

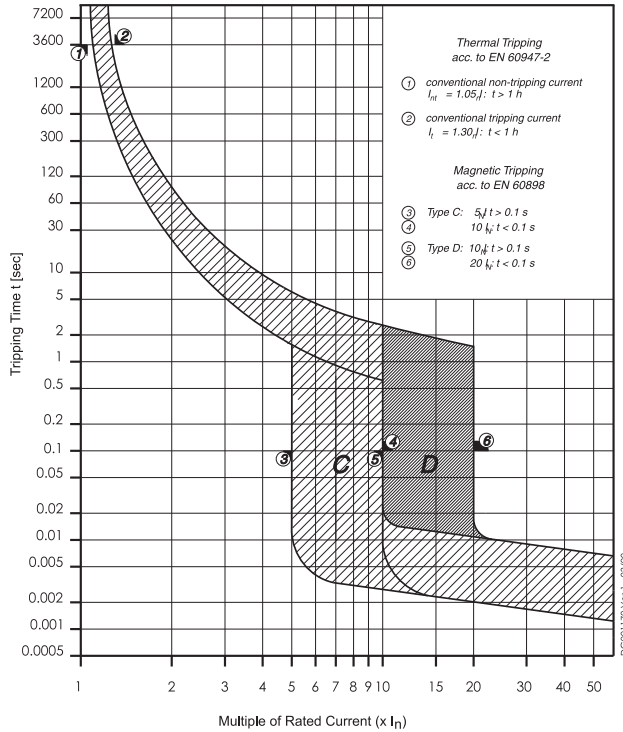

Characteristics C and D - UL 489

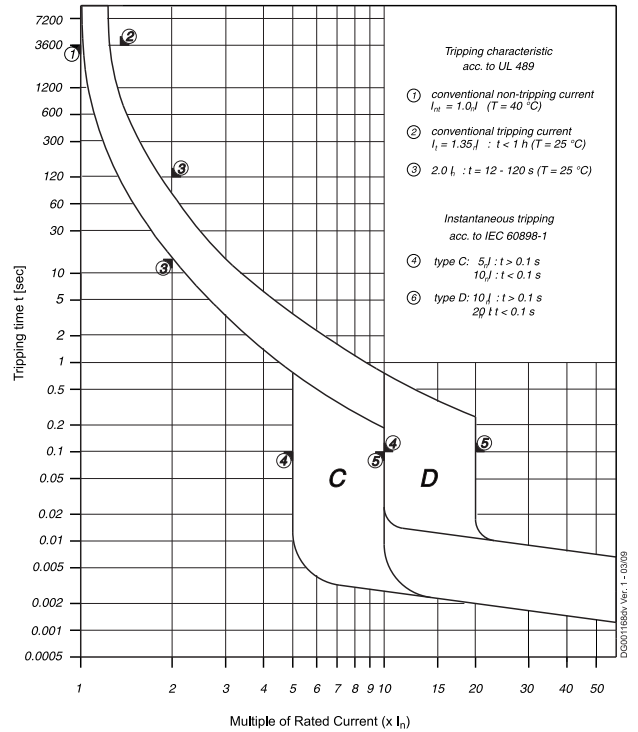

FAZ-...-NA, -RT | Specifications

Internal Resistance FAZ-...-NA, -RT

Type C

At room temperature (single pole)

In [A]	Z* [mΩ]	R [mΩ]
0.5	6400	6300
1	1100	1080
1.5	560	550
2	340	330
3	132	130
4	86	85
5	70	69
6	31	30
7	28	27
8	20	19.6
10	15.8	15.5
13	12.3	12.1
15	7.1	7.0
16	7.1	7.0
20	6.0	5.9
25	4.1	4.0
30	2.8	2.7
32	2.8	2.7
35	2.5	2.5
40	2.1	2.1

* 50Hz

Type D

At room temperature (single pole)

In [A]	Z* [mΩ]	R [mΩ]
0.5	6400	6300
1	770	755
1.5	460	450
2	250	245
3	132	130
4	86	85
5	57	56
6	31	30
7	28	27
8	18	17.6
10	13.5	13.2
13	10.5	10.3
15	5.9	5.8
16	5.9	5.8
20	4.0	3.9
25	3.4	3.3
30	2.5	2.5
32	2.5	2.5
35	2.5	2.5
40	2.0	2.0

* 50Hz

Power Loss at I_n FAZ-...-NA, -RT

Type C

In [A]	P* [W]		
	1p	2p	3p
0.5	1.6	3.2	4.7
1	1.1	2.2	3.4
1.5	1.3	2.6	3.9
2	1.4	2.8	4.3
3	1.2	2.4	3.6
4	1.4	2.9	4.3
5	1.9	3.7	5.6
6	1.2	2.3	3.5
7	1.4	2.8	4.3
8	1.4	2.8	4.2
10	1.8	3.6	5.3
13	2.4	4.7	7.1
15	1.9	3.8	5.6
16	2.1	4.3	6.4
20	2.9	5.8	8.7
25	3.1	6.2	9.3
30	3.0	6.0	9.0
32	3.4	6.8	10.2
35	3.7	7.4	11.0
40	4.0	8.1	12.1

*50Hz

Type D

In [A]	P* [W]		
	1p	2p	3p
0.5	1.6	3.2	4.8
1	0.8	1.5	2.3
1.5	1.0	2.1	3.1
2	1.0	2.1	3.1
3	1.2	2.4	3.6
4	1.4	2.9	4.3
5	1.5	2.9	4.4
6	1.2	2.3	3.5
7	1.4	2.8	4.3
8	1.2	2.4	3.7
10	1.5	3.0	4.5
13	2.0	4.1	6.1
15	1.5	3.1	4.6
16	1.7	3.5	5.2
20	1.8	3.7	5.5
25	2.6	5.1	7.7
30	2.7	5.4	8.1
32	3.1	6.2	9.3
35	3.8	7.6	11.3
40	3.9	7.8	11.6

*50Hz

FAZ-...-NA, -RT | Specifications

Maximum Let-Through Energy FAZ-...-NA, -RT

Type C (0.5 - 32 A), 277 V

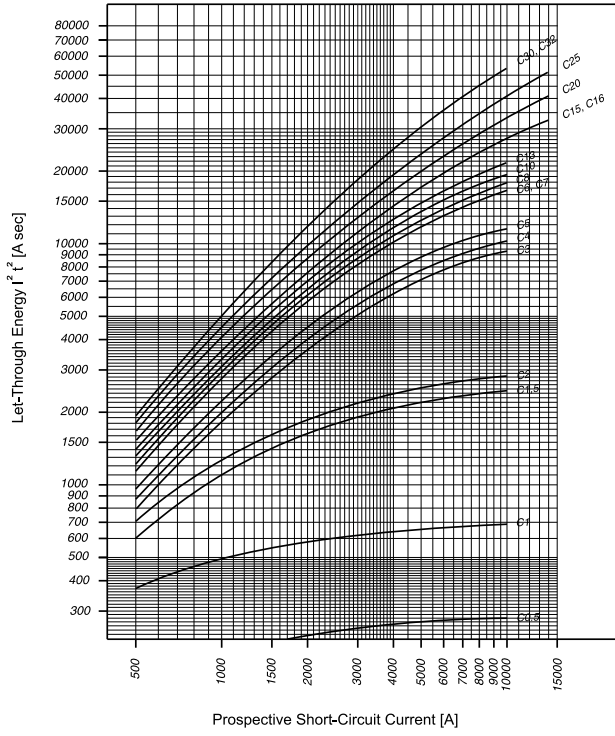

Type C (35 - 40 A), 240 V

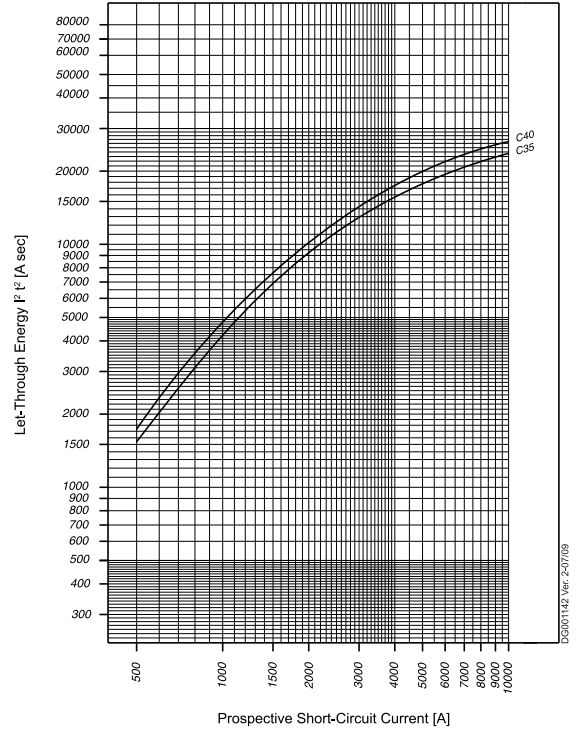

Type D (0.5 - 32 A), 277 V

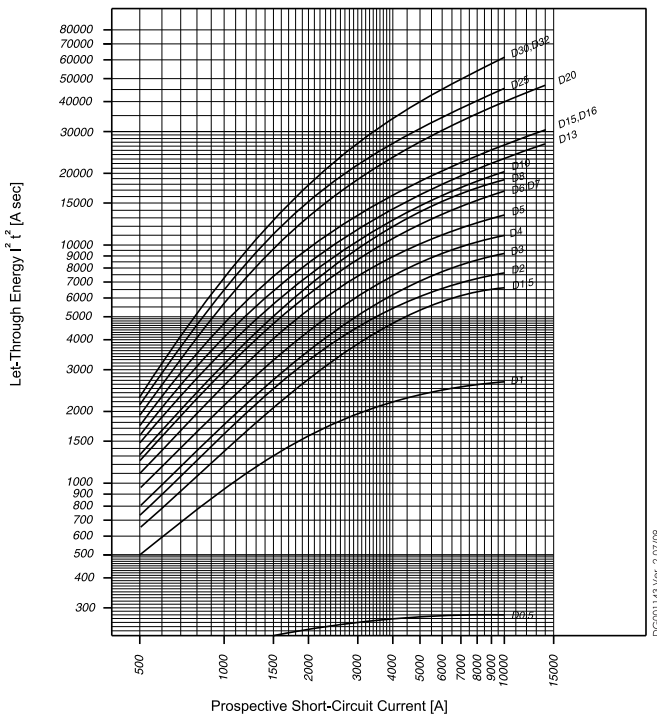

Type D (35 - 40 A), 240 V

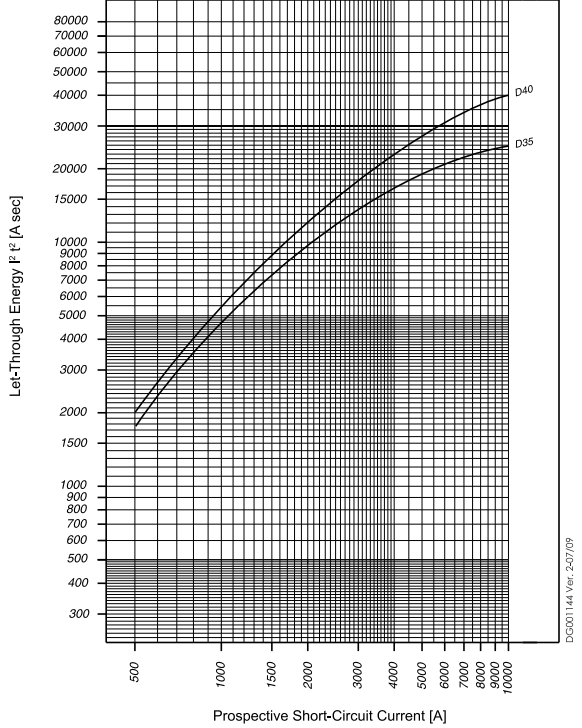

FAZ-...-NA, -RT | Specifications

Maximum Let-Through Current FAZ-...-NA, -RT

Type C (0.5 - 32 A), 277 V

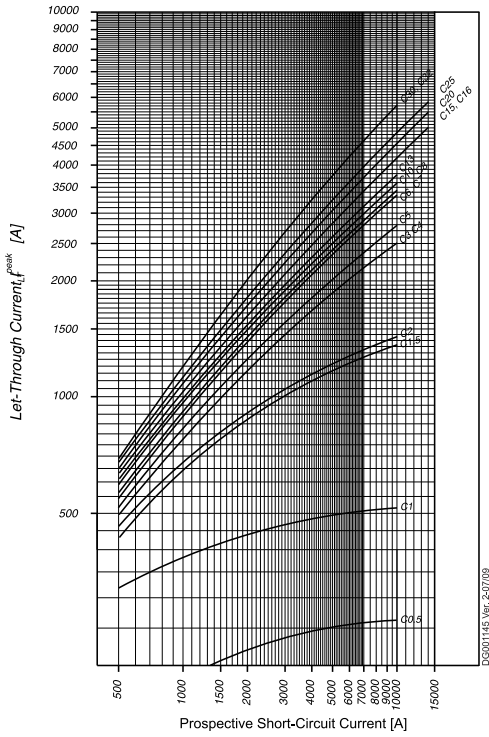

Type C (35 - 40 A), 240 V

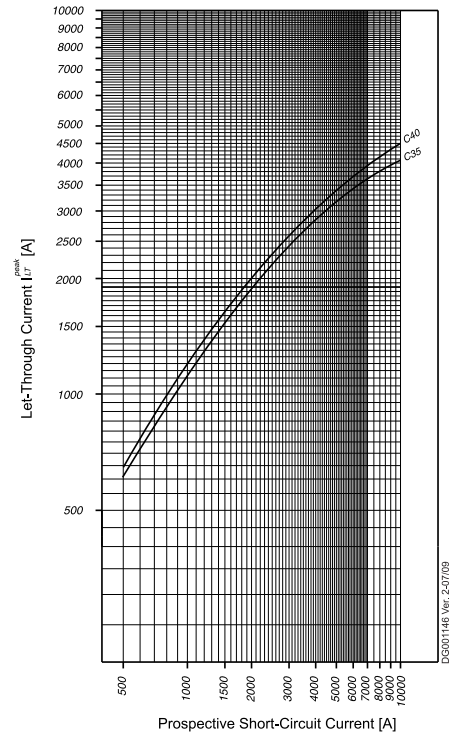

Type D (0.5 - 32 A), 277 V

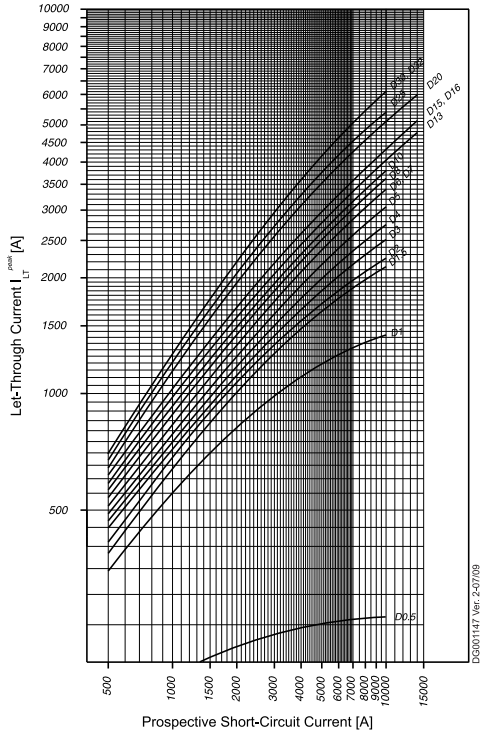

Type D (35 - 40 A), 240 V

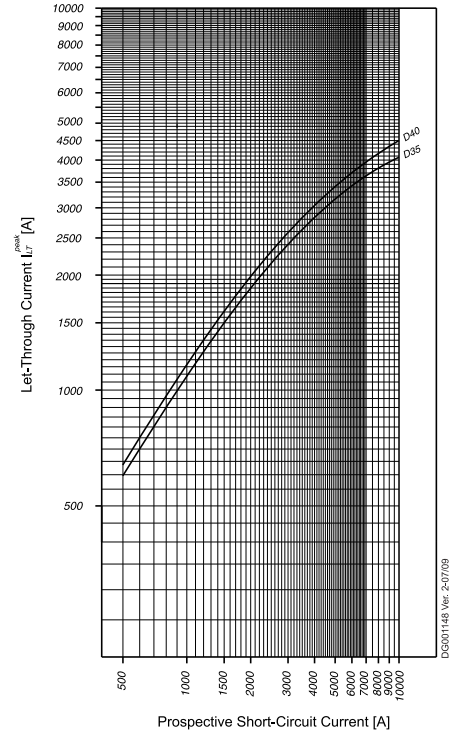

FAZ-...-NA | Busbars

Z-SV/UL-16 Busbars



ATTENTION: Maximum of 3 commoning links allowed. Any combination of same pole configuration.

ATTENTION: 3 liaisons communes autorisées au maximum. Toute combinaison de configurations de polarité identiques.

ACHTUNG: Maximal 3 Schienenblöcke. Beliebige Kombination gleichpoliger Konfigurationen.

ATTENZIONE: Sono consentiti al massimo 3 pettini di collegamento in qualsiasi combinazione della stessa configurazione di poli.

ATENCIÓN: Se permite un máximo de 3 enlaces comunes. Cualquier combinación del mismo tipo de configuración de polo



ATTENTION: Do not cut.

ATTENTION: Ne pas couper.



ACHTUNG: Nicht durchschneiden.

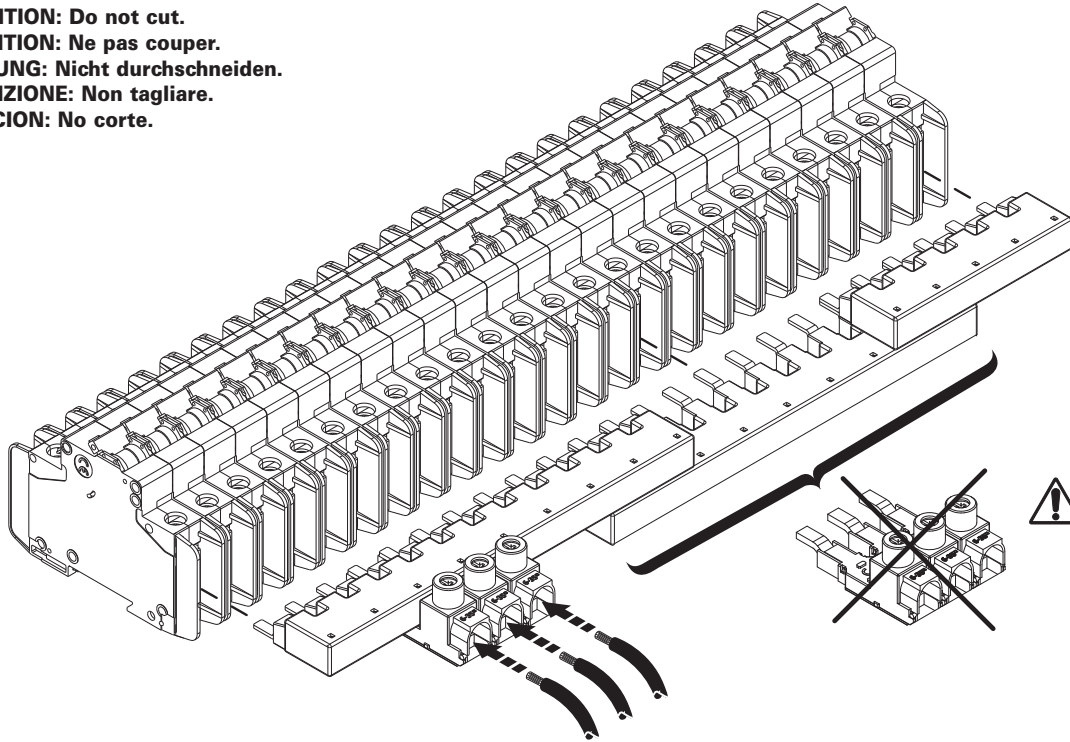

ATTENZIONE: Non tagliare.

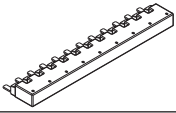
ATENCIÓN: No corte.

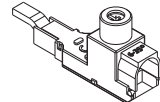

	UL489		EN/IEC 00947-2
U_e	480 V AC	96 V DC	240/415 V AC
f	50/60 Hz	-----	50/60 Hz
U_{imp}	-----		9.5 kV
I_e	80 A @ 40°C		80 A @ 30°C
Gross section	-----		16 mm ²

	UL489		EN/IEC 00947-2
U_e	480 V AC	96 V DC	240/415 V AC
f	50/60 Hz	-----	50/60 Hz
U_{imp}	-----		9.5 kV
I_e	115 A @ 40°C		160 A @ 30°C
	#1-14 AWG 60/75°C Cu	1.5-50 mm ² Cu	
	0.56 in		14 mm

	UL489		EN/IEC 00947-2
U_e	480 V AC	96 V DC	240/415 V AC
f	50/60 Hz	-----	50/60 Hz
U_{imp}	-----		9.5 kV
I_e	80 A @ 40°C		80 A @ 30°C
	#2-14 AWG 60/75°C Cu	2.5-35 mm ² Cu	
	0.56 in		14 mm

FAZ-...-NA | Busbars

Z-SV/UL-16 Busbars

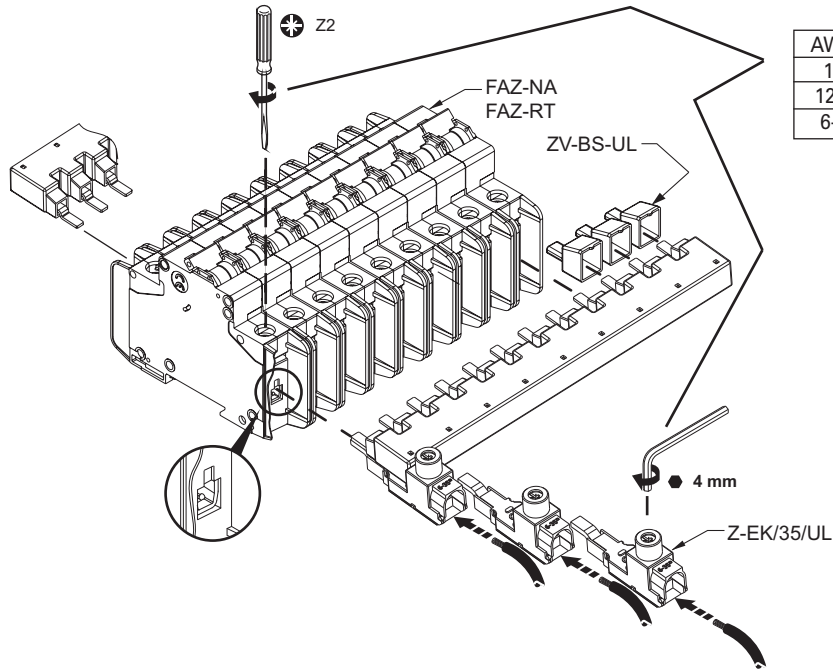

AWG	lb-in	Nm
14	21	2.3
12-8	25	2.8
6-2	36	4.0

IEC/EN 60947-2 Icc

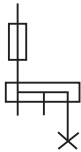
	U _e VAC	Z-SV/UL I _{cc} Amps
	240/ 415	15000



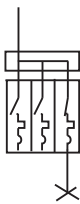

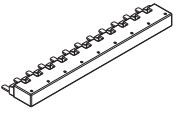
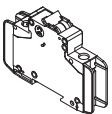
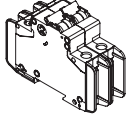
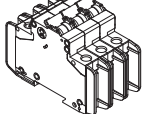
UL SCCR

	FAZ-NA FAZ-RT I _n Amps	U _e VAC	Z-SV/UL SCCR RMS Sym Amps
	0.5-32	480Y/ 277	10000
	35-40	240	10000

Article No.				
104892	Z-SV/UL-16/1P-1TE/6	6	-	-
104893	Z-SV/UL-16/1P-1TE/12	12	-	-
104894	Z-SV/UL-16/1P-1TE/18	18	-	-
104895	Z-SV/UL-16/2P-2TE/6	-	3	-
104896	Z-SV/UL-16/2P-2TE/12	-	6	-
104897	Z-SV/UL-16/2P-2TE/18	-	9	-
104898	Z-SV/UL-16/3P-3TE/6	-	-	2
104899	Z-SV/UL-16/3P-3TE/12	-	-	4
104900	Z-SV/UL-16/3P-3TE/18	-	-	6
104901	Z-EK/35/UL	-	-	-
104902	Z-EB/50/UL	-	-	-
104904	ZV-BS-UL	-	-	-

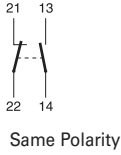
FAZ-...-NA, -RT | Accessories

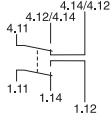
Auxiliary Contacts and Voltage Trips

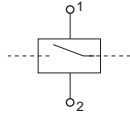
	Circuit Diagram	Description	Rated Operational Voltage	Type Designation	Article No.	Units per package
SG60711 		Auxiliary contact <ul style="list-style-type: none"> • Design according to IEC/EN 60947-5-1, IEC/EN 62019 • Field installable • The specified minimum voltages are per contact—take into account particularly in case of series connection • Self-cleaning contacts • Contact material and design particularly suitable for extra low voltage • Tripping signal contact transmits message of electric tripping, not mechanical switch-off • Test key for contact function “electrical tripping” • Will allow for > 480Y/277 Vac rating 	250 Vac	Z-IHK-NA	113895	1
SG61011 		Two-pole auxiliary contact/trip indicating contact *) <ul style="list-style-type: none"> • Design according to IEC/EN 60947-5-1, IEC/EN 62019 • Field installable • The specified minimum voltages are per contact—take into account particularly in case of series connection • Self-cleaning contacts • Contact material and design particularly suitable for extra low voltage • Tripping signal contact transmits message of electric tripping, not mechanical switch-off • Test key for contact function “electrical tripping” • The function of one of the two change-over contacts can be switched from “auxiliary switch” to “tripping signal switch” *) Voltage of FAZ-NA circuit breaker is limited to 300V with this auxiliary contact installed	250 Vac	Z-NHK	248434	1
SG13511 		Shunt Trip <ul style="list-style-type: none"> • Remote release for subsequent mounting onto FAZ-NA • Additional installation of standard auxiliary switch is possible • Position indicator red-green 	12–110 Vac 12–60 Vdc	FAZ-XAA-NA12-110VAC FAZ-XAA-NA110-415VAC	102037 102036	1 1
		Padlock Hasp (for all FAZ) <ul style="list-style-type: none"> • Prevents reactivation of the device during maintenance • Holds one padlock 		IS/SPE-1TE	101911	1

FAZ-...-NA, -RT | Accessories

Specifications

Technical Data

	Z-NHK	Z-IHK-NA
Electrical		
Contact function	2CO	1NO + 1NC
Rated voltage	230V	250V
Rated current	2A	6A
Rated thermal current I_{th}	2A	6A
Utilization category AC13		
Rated operational current I_e	3A/250 Vac	3A/250 Vac
Utilization category AC15		
Rated operational current I_e	2A/250 Vac	2A/250 Vac
Utilization category DC12		
Rated operational current I_e	0.5A/110 Vdc	0.5A/110 Vdc 0.25A/220 Vdc
Rated insulation voltage U _i	250 Vac	250 Vac
Minimum operational voltage per contact U _{min}	5 Vdc	5 Vdc
Minimum operational current I _{min}	10 mA DC	10 mA AC/DC
Rated peak withstand voltage U _{imp} (1.2/50μ)	2.5 kV	4 kV
Conditional short circuit current I _k		
with Back-Up Fuse 6A	1 kA	1 kA
Max. back-up fuse, overload and short circuit	6A gL	—
Mechanical		
Tripping indicator "electrical tripping"	Blue/white	—
Frame size	45 mm	45 mm
Device height	80 mm	80 mm
Device width	8.8 mm (0.5MU)	8.8 mm (0.5MU)
Mounting	Onto switching device	—
Degree of protection, built-in	IP40	IP40
Terminal protection	Finger and hand touch safe according to BGV A3, ÖVE-EN 6	Finger and hand touch safe according to BGV A3, ÖVE-EN 6
Terminals	Lift terminals	Lift terminals
Terminal capacity	20–14 AWG	0.5–2.5 mm ²
Terminal screws	M3 (Pozidrive Z0)	M3 (Pozidrive Z0)
Tightening torque of terminal screws	7 lb-in	max. 1.2 Nm

Two-pole auxiliary contact/trip indicating contact

Z-NHK

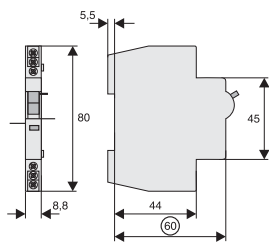

Auxiliary contact

Z-IHK-NA

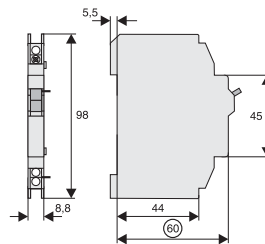

FAZ-...-NA, -RT | Accessories

Technical Data

	FAZ-XAA-NA12-110VAC	FAZ-XAA-NA110-415VAC
Electrical		
Can be mounted onto	FAZ-NA / FAZ-NA-DC / FAZ-RT	FAZ-NA / FAZ-NA-DC / FAZ-RT
Operational voltage range	12–110 Vac	110–415 Vac
	12–60 Vdc	110–230 Vdc
Frequency	50/60 Hz	50/60 Hz
Mechanical		
Frame size	45 mm	45 mm
Device height	105 mm	105 mm
Device width	17.5 mm	17.5 mm
Mounting	Quick fastening with two lock-in positions on EN 50022	
Degree of protection, built-in	IP40	IP40
Terminal protection	Finger and hand touch safe according to BGV A3, ÖVE-EN 6	Finger and hand touch safe according to BGV A3, ÖVE-EN 6
Terminals	Open mouthed/lift	Open mouthed/lift
Terminal capacity, one and two wires	18–10 AWG	18–10 AWG

Eaton is dedicated to ensuring that reliable, efficient and safe power is available when it's needed most. With unparalleled knowledge of electrical power management across industries, experts at Eaton deliver customized, integrated solutions to solve our customers' most critical challenges.

Our focus is on delivering the right solution for the application. But, decision makers demand more than just innovative products. They turn to Eaton for an unwavering commitment to personal support that makes customer success a top priority.

For more information, visit www.eaton.com/electrical.

Addresses worldwide:
www.moeller.net/address

E-Mail: InfoAustria@eaton.com
Internet: www.eaton.com

Publisher:
Eaton Industries (Austria) GmbH
Eugenia 1
A-3943 Schrems

© 2012 by Eaton
Subject to alterations
Productinformation FAT

Printed in Austria (01/12)
Graphics: SRA
DigiPics, Lithos: Jonas, Heidenreichstein
Print:
Article No.



Powering Business Worldwide

X-ON Electronics

Largest Supplier of Electrical and Electronic Components

Click to view similar products for [Circuit Breakers](#) category:

Click to view products by [Eaton](#) manufacturer:

Other Similar products are found below :

[M39019/04-249S](#) [M39019/04-313S](#) [M55629/1-001](#) [M55629/1-016](#) [M55629/1-018](#) [M55629/1-021](#) [M55629/1-033](#) [M55629/1-036](#) [M55629/1-046](#) [M55629/1-048](#) [M55629/1-058](#) [M55629/1-060](#) [M55629/1-067](#) [M55629/1-070](#) [M55629/1-079](#) [M55629/1-084](#) [M55629/1-085](#) [M55629/1-101](#) [M55629/1-108](#) [M55629/1-109](#) [M55629/11-102](#) [M55629/1-120](#) [M55629/12-045](#) [M55629/12-046](#) [M55629/1-243](#) [M55629/1-330](#) [M55629/1-331](#) [M55629/1-351](#) [M55629/1-366](#) [M55629/1-387](#) [M55629/1-388](#) [M55629/1-401](#) [M55629/1-430](#) [M55629/1-450](#) [M55629/1-453](#) [M55629/2-022](#) [M55629/2-037](#) [M55629/2-082](#) [M55629/2-099](#) [M55629/2-101](#) [M55629/2-102](#) [M55629/2-115](#) [M55629/2-116](#) [M55629/2-183](#) [M55629/21-HM-HM](#) [M55629/21-NS-NS](#) [M55629/21-SK-UK](#) [M55629/22-NR-NR-NR](#) [M55629/22-RS-RS-RS](#) [M55629/22-TM-TM-TM](#)