

SILICON EPITAXIAL PLANAR NPN TRANSISTOR

MG6330, MG6330-R

- TO-3P Plastic Package
- Complimentary PNP – MG9410
- Designed specifically for audio power amplifier applications
- High Current audio bipolar with wide Safe Operating Area

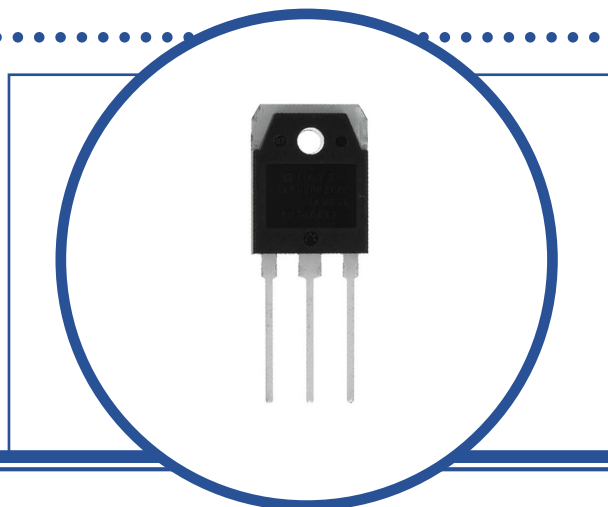

ABSOLUTE MAXIMUM RATINGS (T_A = 25°C unless otherwise stated)

		MG6330	MG6330-R
V _{CB0}	Collector – Base Voltage	230V	260V
V _{CEO}	Collector – Emitter Voltage	230V	260V
V _{EBO}	Emitter – Base Voltage		5V
I _C	Continuous Collector Current		15A
I _B	Base Current		4A
P _D	Total Power Dissipation at T _A = 25°C		200W
T _J	Maximum Junction Temperature		150°C
T _{stg}	Storage Temperature Range		-55 to +150°C

THERMAL PROPERTIES

Symbols	Parameters	Min.	Typ.	Max.	Units
R _{θJC}	Thermal Resistance, Junction To Case			0.63	°C/W

Semelab Limited reserves the right to change test conditions, parameter limits and package dimensions without notice. Information furnished by Semelab is believed to be both accurate and reliable at the time of going to press. However Semelab assumes no responsibility for any errors or omissions discovered in its use. Semelab encourages customers to verify that datasheets are current before placing orders.

SILICON EPITAXIAL PNP TRANSISTOR MG6330, MG6330-R

ELECTRICAL CHARACTERISTICS ($T_A = 25^\circ\text{C}$ unless otherwise stated)

Symbols	Parameters	Test Conditions		Min.	Typ	Max.	Units
I_{CBO}	Collector-Cut-Off Current	MG6330	$V_{CB} = 230\text{V}$			100	μA
		MG6330-R	$V_{CB} = 260\text{V}$				
I_{EBO}	Emitter-Cut-Off-Current	$V_{EB} = 5\text{V}$				100	μA
$V_{(BR)CEO}$	Collector-Base Breakdown Voltage	$I_C = 25\text{mA}$	MG6330	230			V
			MG6330-R	260			
$V_{CE(sat)}^{(1)}$	Collector-Emitter Saturation Voltage	$I_C = 5\text{A}$	$I_B = 0.5\text{A}$			2.0	V
h_{FE}	Forward-current transfer ratio	$I_C = 5\text{A}$	$V_{CE} = 4\text{V}$	70		140	

DYNAMIC CHARACTERISTICS

f_T	Transition Frequency	$I_E = -2\text{A}$	$V_{CE} = 12\text{V}$		60		MHz
C_{OB}	Output Capacitance	$V_{CB} = 10\text{V}$	$f = 1.0\text{MHz}$		250		pF

Notes

Pulse Width $\leq 300\mu\text{s}$, $\delta \leq 2\%$

SILICON EPITAXIAL PNP TRANSISTOR MG6330, MG6330-R

TYPICAL CHARACTERISTICS ($T_A = 25^\circ\text{C}$ unless otherwise stated)

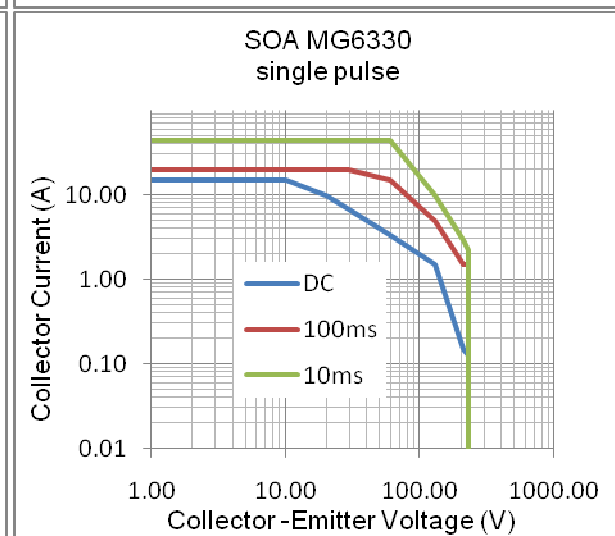
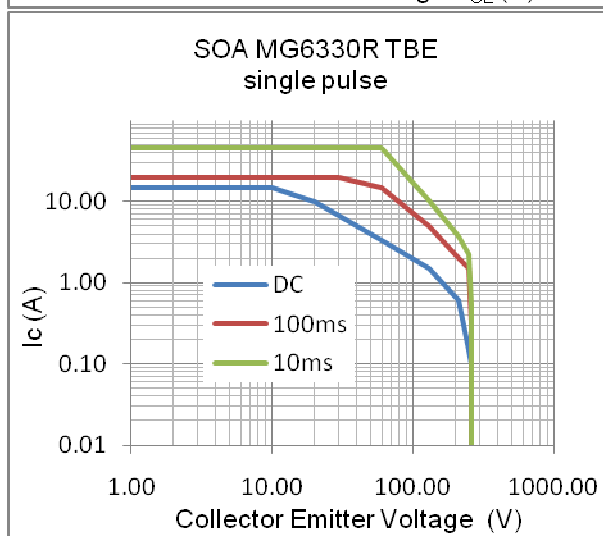
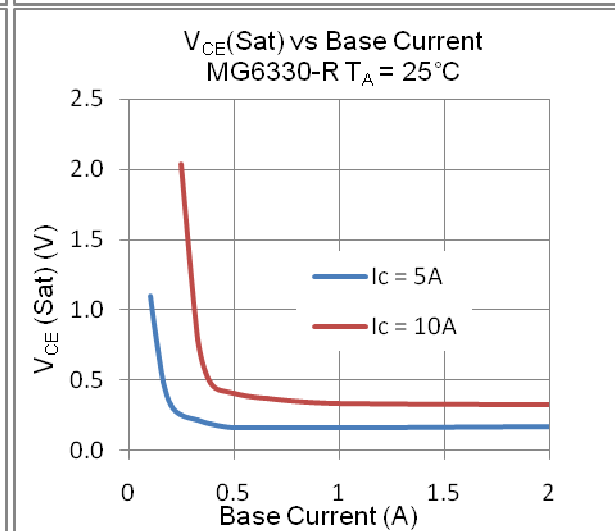
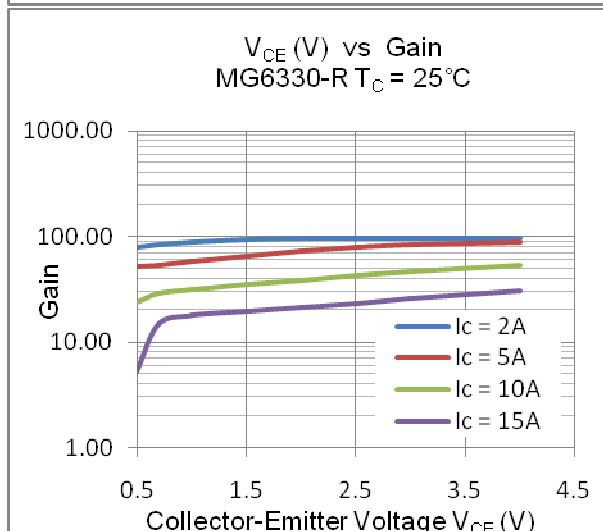
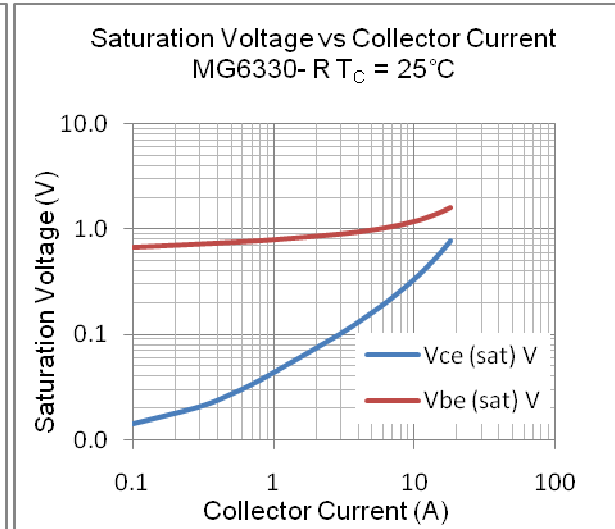
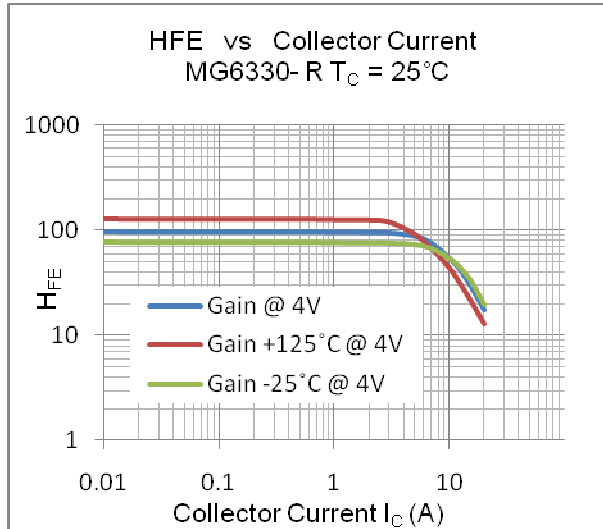

SILICON EPITAXIAL PNP TRANSISTOR MG6330, MG6330-R

TYPICAL CHARACTERISTICS CONTINUED ($T_A = 25^\circ\text{C}$ unless otherwise stated)

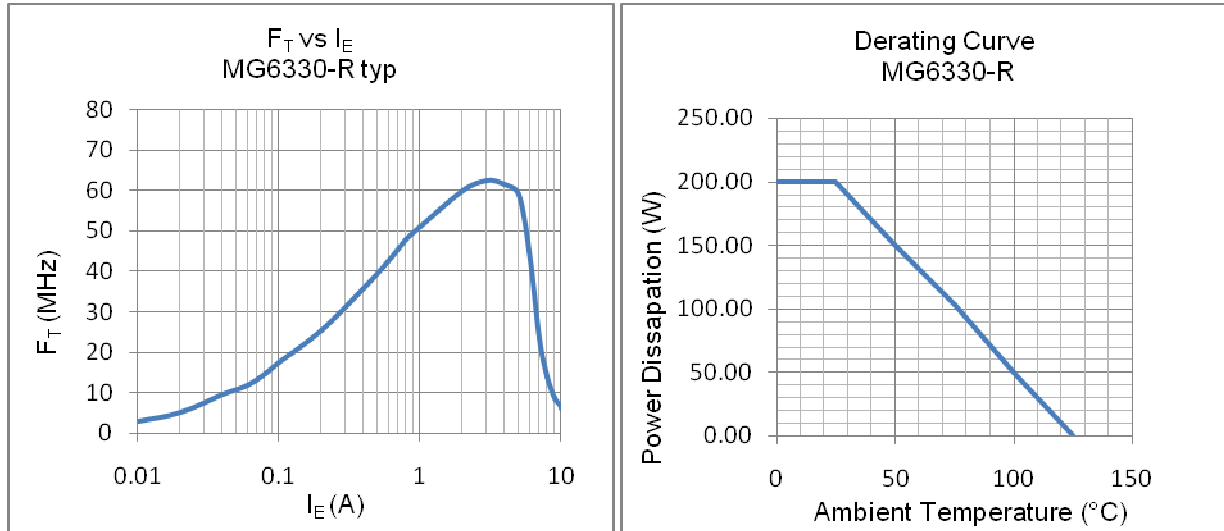

MECHANICAL DATA

Dimensions in mm (inches)

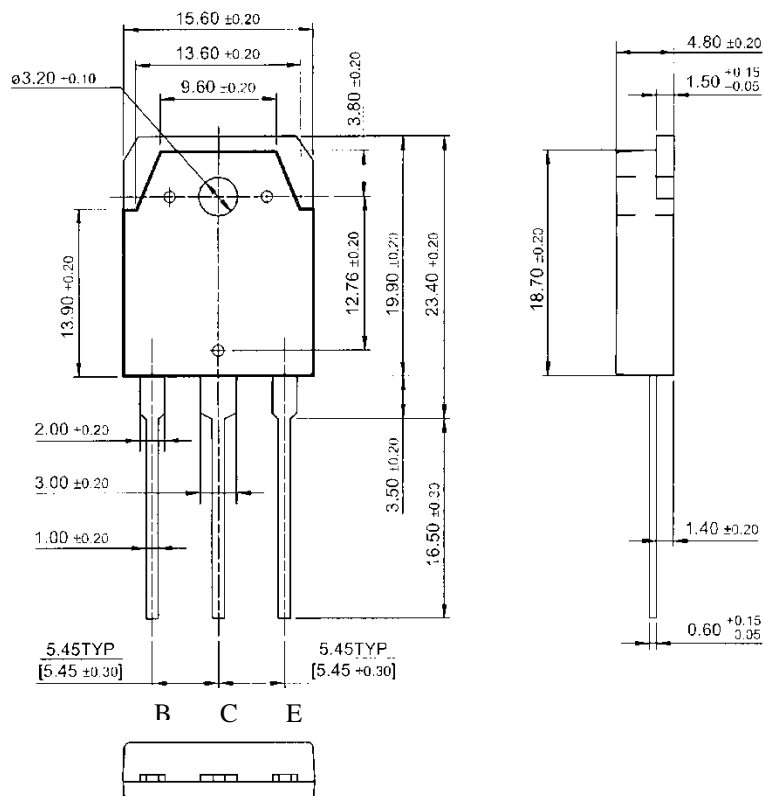

TO3P
Pin1 – Base Pin2 – Collector Pin3 - Emitter

X-ON Electronics

Largest Supplier of Electrical and Electronic Components

Click to view similar products for [tt electronics](#) manufacturer:

Other Similar products are found below :

[L083S392LF](#) [L061S391LF](#) [L091S224LF](#) [L061S220LF](#) [BCN164A562J7](#) [62PR25KLF](#) [CHP1501R00FLF](#) [BCN164AB470J7](#) [898-3-R150K](#)
[66XR10](#) [66XR200K](#) [66XR2K](#) [66XR50](#) [67WR1MEG](#) [67WR200KLFTB](#) [67ZR200](#) [68WR5K](#) [68XR2MEG](#) [72PXR10K](#) [72XR2.5K](#) [8109](#)
[82PR25K](#) [84WR10KTR](#) [PWC2512-330RJI](#) [OPB660N](#) [OPB748WZ](#) [OPB842W51Z](#) [OPB870T55](#) [OPI1266](#) [P110KV1-0Y20BR50K](#)
[P170SP1-FC15AR10K](#) [89XHR10K](#) [L083C101](#) [91XR5K](#) [SML100M12MSF](#) [PFC-W0805LF-03-2870-B](#) [2627](#) [CR200L.5](#) [RC07GF220J](#)
[RC55LF-D-196R-B-B](#) [3371R5KL.5](#) [HM00-01800](#) [HM71-10220LFTR](#) [3371R5KL.25](#) [L083C122](#) [WH25-47RJI](#) [WH5-100RJI](#) [040585XM](#)
[6679-420-0](#) [OP231](#)