

H-MOSS[®]|MAXX[™] Products



**Extra Duty Energy Saving Controls
for Harsh Environments**

Eliminate Wasted Energy In Extreme Conditions

Typical energy management controls are designed for indoor, clean, environmentally controlled areas. Hubbell created **H-MOSS®|MAXX™** to provide tough energy management controls for harsh and demanding environments where traditional products may not survive. Properly deployed controls can lead to significant savings in these environments.

Wet and Damp

H-MOSS®|MAXX™ sensors are designed for use in areas where there will be exposure to spray, wash down, moisture, and precipitation. Match the NEMA or IP rating to your application to ensure optimum performance.



Cold and Hot

H-MOSS®|MAXX™ sensors and control packs provide an expanded operating temperature range from -40°F to 149°F (-40°C to 65°C). This supports cold storage, freezer, outdoor, and unconditioned spaces found in industrial environments.



Outdoor and Unconditioned

The AHP1600WRP and IP65 fixture mount **H-MOSS®|MAXX™** sensors are specifically UL rated for outdoor use. These units provide control solutions for exterior lighting, parking garages, loading docks and public rest rooms.







High and Reactive Loads

The CU300HD **H-MOSS®|MAXX™** control unit incorporates a high performance mechanical latching relay. This enables full 20A general purpose switching to support many types of lighting, motor, and plug loads.

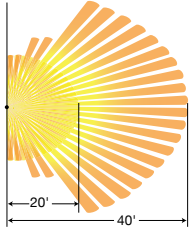

Select the Right Sensor for Your Application

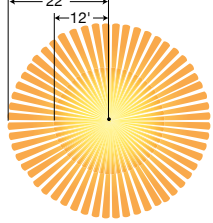
H-MOSS®|**MAXX**™ sensors come with different enclosure ratings and features to support a broad range of applications. Match the product specifications below to your requirements. Utilize units with isolated low voltage relays to signal occupancy or vacancy to HVAC and other automation systems.

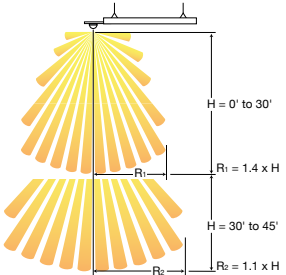
	Enclosure Rating	Coverage	Mounting Style	Voltage	Isolated Relay	Photocell
 AHP1600WRP with HAP1	NEMA 4X / IP66 & Outdoor		Wall or Pendant 160° View	24V DC (Use CU300HD Control Unit)	Yes	Yes
 AHP1500CRP with ACIPE	NEMA 4X / IP66		Ceiling Mount 360° View	24V DC (Use CU300HD Control Unit)	Yes	Yes
 HMHB21UPCW	NEMA 3R / IP65 & Outdoor		Fixture or Junction Box 360° View Optional: 180°, Aisle, End-of-Aisle Views	120-347V AC or 240V AC, 480V AC, 24V DC	No	Yes

Properly Mount and Position Sensors

H-MOSS®|**MAXX**™ sensors utilize digital passive infrared (PIR) technology to sense human body heat in motion. These sensors need to have line of site to sense occupancy. For optimum performance, they must be mounted and positioned properly. Use the mounting adaptors where applicable and utilize multiple sensors with overlapping coverage for increased sensitivity.

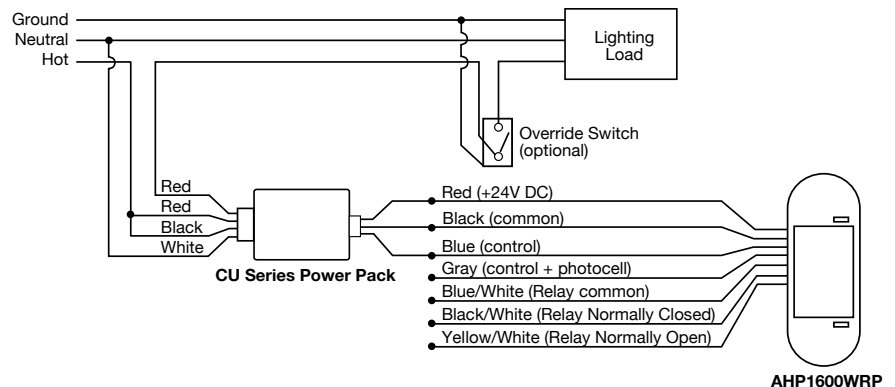

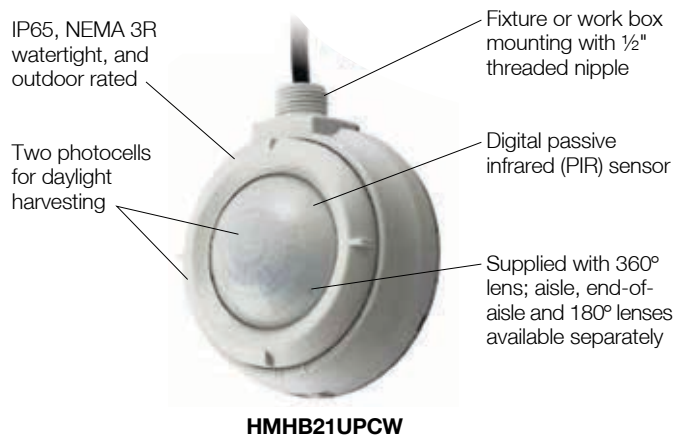
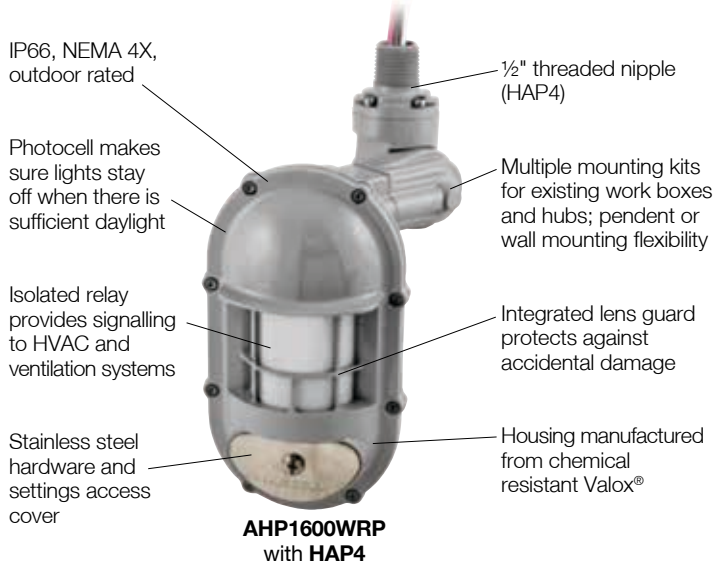

Outdoor Rated Watertight Wall Mount PIR Sensor

IP66, NEMA 4X, heavy duty wall or pendant mount sensor with -40°F to 149°F (-40°C to 65°C) operating temperature range and 160° of coverage.

Description	Voltage	Catalog Number
PIR sensor, with isolated relay and photocell	24V DC	AHP1600WRP
Adaptor plate for 1-gang FS boxes	—	HAP1
Adaptor hub and nipple for Killark NJ series boxes	—	HAP2
Adaptor plate for Killark NV series boxes	—	HAP3
1/2" NPT threaded hub, supplied with AHP1600WRP	—	HAP4



AHP1600WRP

Extreme Temperature PIR Ceiling Sensor

Upgraded ceiling sensor with -40°F to 149°F (-40°C to 65°C) operating temperature range. Use ACIPE to make NEMA 4X watertight.

Description	Voltage	Catalog Number
PIR sensor, with isolated relay and photocell	24V DC	AHP1500CRP
NEMA 4X enclosure, IP66	—	ACIPE

Note: For use with a CU series control unit: CU300HD (120/277V AC, 50/60 Hz), CU347A (347V AC, 60 Hz).



ACIPE with AHP1500CRP

Heavy Duty Control Unit

Robust latching relay provides reliable performance over many different applications, including plug loads. 20A 100-277V AC, 1HP @ 120V, 2HP @ 240/277V. Auto or Manual-On operation. Powers up to six low voltage sensors.

Description	Voltage	Catalog Number
Heavy duty control unit	120-277V AC	CU300HD



CU300HD

Watertight OPTIMYZER®

IP65, NEMA 3R, outdoor rated, -40°F to 149°F (-40°C to 65°C) operating temperature range.

Description	Voltage	Catalog Number
PIR sensor, relay with photocell	120-347V AC	HMHB21UPCW
PIR sensor, 2 relays with photocell	120-347V AC	HMHB22UPCW
PIR sensor, 1 double pole relay with photocell	208, 240V AC	HMHB23APCW
PIR sensor, 1 double pole relay with photocell	480V AC	HMHB23BPCW
PIR sensor, with photocell	24V DC	HMHB21VPCW*
180° Lens	—	HMHBL180
360° Lens (included)	—	HMHBL360
Aisle lens	—	HMHBLA
End-of-aisle lens, 180° plus aisle	—	HMHBLEA



HMHB21UPCW

Valox® is a trademark of SABIC Innovative Plastics, acquired from General Electric Company.

HUBBELL®
Wiring Device-Kellems

www.hubbell-wiring.com



X-ON Electronics

Largest Supplier of Electrical and Electronic Components

Click to view similar products for [hubbell](#) manufacturer:

Other Similar products are found below :

[CFB7TALU](#) [03301045](#) [02216024](#) [03301047](#) [5369VY](#) [5461](#) [WSS1P](#) [00322005LPK50](#) [01304055](#) [M001SG000](#) [M001SG00P](#) [M11MSP](#)
[01301013](#) [02201005](#) [02202008](#) [02203007](#) [02203064](#) [02206012](#) [02211003](#) [02211019](#) [02402005](#) [02406006](#) [02407008](#) [CS1223GY](#) [CS6360C](#)
[CS6370](#) [7310](#) [MCMA14110](#) [7485VBLK](#) [7585](#) [7716](#) [7967](#) [FF3I](#) [PF2004PA005](#) [PFOLT312](#) [PH2003PA010](#) [PH2304PB050](#) [PH6598W](#) [9308](#)
[GFP2305](#) [GFR5352IA](#) [GFR5362WTR](#) [GFR8300SNAPBKNA](#) [PM3004PA015](#) [HBL13R12D](#) [HBL16LEDR](#) [HBL18201WCN](#)
[HBL20GBA612IV](#) [HBL20IG606GY](#) [HBL23007](#)