



MIC5301

Single, 150mA μ Cap ULDO™

General Description

The MIC5301 is a high performance, single output ultra low LDO (ULDO™) regulator, offering low total output noise. The MIC5301 is capable of sourcing 150mA output current and offers high PSRR and low output noise, making it an ideal solution for RF applications.

For battery operated applications, the MIC5301 offers 2% accuracy, extremely low dropout voltage (40mV @ 150mA), and low ground current (typically 85 μ A total). The MIC5301 can also be put into a zero-off-mode current state, drawing no current when disabled.

The MIC5301 is available in the 1.6mm x 1.6mm Thin MLF® package, occupying only 2.56mm² of PCB area, a 36% reduction in board area compared to SC-70 and 2mm x 2mm MLF® packages.

The MIC5301 has an operating junction temperature range of -40°C to +125°C and is available in fixed and adjustable output voltages in lead-free (RoHS compliant) Thin MLF® and Thin SOT-23-5 packages.

Data sheets and support documentation can be found on Micrel's web site at www.micrel.com.

Features

- Ultra low dropout voltage – 40mV @ 150mA
- Input voltage range: 2.3V to 5.5V
- 150mA guaranteed output current
- Stable with ceramic output capacitors
- Ultra low output noise – 30 μ Vrms
- Low quiescent current – 85 μ A total
- High PSRR – up to 75dB@1kHz
- 35 μ s turn-on time
- High output accuracy
- \pm 2% initial accuracy
- \pm 3% over temperature
- Thermal shutdown and current limit protection
- Tiny 6-pin 1.6mm x 1.6mm Thin MLF® leadless package
- Thin SOT-23-5 package
-

Applications

- Mobile phones
- PDAs
- GPS receivers
- Portable electronics
- Digital still and video cameras
-

Typical Application

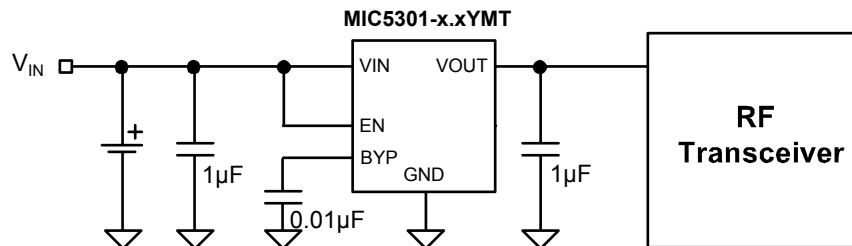

Portable Application

ULDO is a trademark of Micrel, Inc.

MLF and *MicroLeadFrame* are registered trademarks of Amkor Technology, Inc.

Micrel Inc. • 2180 Fortune Drive • San Jose, CA 95131 • USA • tel +1 (408) 944-0800 • fax + 1 (408) 474-1000 • <http://www.micrel.com>

Ordering Information

Part number	Marking Code ⁽¹⁾	Output Voltage ⁽²⁾	Temperature Range	Package
MIC5301-2.85YML ⁽⁴⁾	<u>2</u> JC	2.85V	-40°C to +125°C	6-Pin 1.6mm x 1.6mm MLF [®]
MIC5301YML ⁽⁴⁾	<u>C</u> AA	ADJ.	-40°C to +125°C	6-Pin 1.6mm x 1.6mm MLF [®]
MIC5301-1.3YMT ^(3,4)	13C	1.3V	-40°C to +125°C	6-Pin 1.6mm x 1.6mm Thin MLF [®]
MIC5301-1.5YMT ^(3,4)	15C	1.5V	-40°C to +125°C	6-Pin 1.6mm x 1.6mm Thin MLF [®]
MIC5301-1.8YMT ^(3,4)	18C	1.8V	-40°C to +125°C	6-Pin 1.6mm x 1.6mm Thin MLF [®]
MIC5301-2.1YMT ^(3,4)	21C	2.1V	-40°C to +125°C	6-Pin 1.6mm x 1.6mm Thin MLF [®]
MIC5301-2.5YMT ^(3,4)	25C	2.5V	-40°C to +125°C	6-Pin 1.6mm x 1.6mm Thin MLF [®]
MIC5301-2.6YMT ^(3,4)	26C	2.6V	-40°C to +125°C	6-Pin 1.6mm x 1.6mm Thin MLF [®]
MIC5301-2.8YMT ^(3,4)	28C	2.8V	-40°C to +125°C	6-Pin 1.6mm x 1.6mm Thin MLF [®]
MIC5301-2.85YMT ^(3,4)	2JC	2.85V	-40°C to +125°C	6-Pin 1.6mm x 1.6mm Thin MLF [®]
MIC5301-2.9YMT ^(3,4)	29C	2.9V	-40°C to +125°C	6-Pin 1.6mm x 1.6mm Thin MLF [®]
MIC5301-3.0YMT ^(3,4)	30C	3.0V	-40°C to +125°C	6-Pin 1.6mm x 1.6mm Thin MLF [®]
MIC5301-3.3YMT ^(3,4)	33C	3.3V	-40°C to +125°C	6-Pin 1.6mm x 1.6mm Thin MLF [®]
MIC5301-4.6YMT ^(3,4)	46C	4.6V	-40°C to +125°C	6-Pin 1.6mm x 1.6mm Thin MLF [®]
MIC5301YMT ^(3,4)	CAA	ADJ.	-40°C to +125°C	6-Pin 1.6mm x 1.6mm Thin MLF [®]
MIC5301-1.3YD5	<u>QC</u> 13	1.3V	-40°C to +125°C	5-Pin TSOT-23
MIC5301-1.5YD5	<u>QC</u> 15	1.5V	-40°C to +125°C	5-Pin TSOT-23
MIC5301-1.8YD5	<u>QC</u> 18	1.8V	-40°C to +125°C	5-Pin TSOT-23
MIC5301-2.1YD5	<u>QC</u> 21	2.1V	-40°C to +125°C	5-Pin TSOT-23
MIC5301-2.5YD5	<u>QC</u> 25	2.5V	-40°C to +125°C	5-Pin TSOT-23
MIC5301-2.6YD5	<u>QC</u> 26	2.6V	-40°C to +125°C	5-Pin TSOT-23
MIC5301-2.8YD5	<u>QC</u> 28	2.8V	-40°C to +125°C	5-Pin TSOT-23
MIC5301-2.85YD5	<u>QC</u> 2J	2.85V	-40°C to +125°C	5-Pin TSOT-23
MIC5301-2.9YD5	<u>QC</u> 29	2.9V	-40°C to +125°C	5-Pin TSOT-23
MIC5301-3.0YD5	<u>QC</u> 30	3.0V	-40°C to +125°C	5-Pin TSOT-23
MIC5301-3.3YD5	<u>QC</u> 33	3.3V	-40°C to +125°C	5-Pin TSOT-23
MIC5301-4.6YD5	<u>QC</u> 46	4.6V	-40°C to +125°C	5-Pin TSOT-23
MIC5301YD5	<u>Q</u> CAA	ADJ.	-40°C to +125°C	5-Pin TSOT-23

Notes:

1. Under bar / Over bar symbol may not be to scale.
2. Other Voltages available. Contact Micrel for details.
3. Thin MLF[®] Pin 1 indicator = ▲.
4. MLF[®] Thin MLF[®] are GREEN RoHS compliant packages. Lead Finish is NiPdAu. Mold compound is Halogen Free.

Pin Configuration

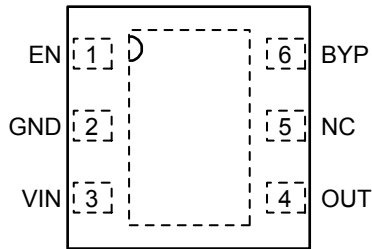

6-Pin 1.6mm x 1.6mm Thin MLF® (MT)
Fixed (Top View)

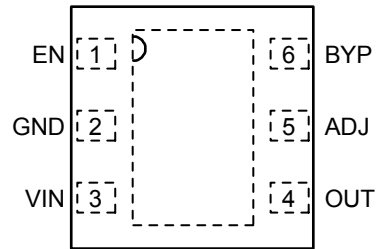

6-Pin 1.6mm x 1.6mm Thin MLF® (MT)
Adjustable (Top View)

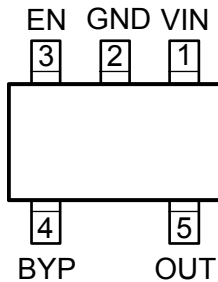

TSOT-23-5 (D5)
Fixed (Top View)

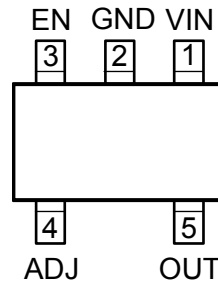

TSOT-23-5 (D5)
Adjustable (Top View)

Pin Description

Pin No. Thin MLF-6 Fixed	Pin No. Thin MLF-6 Adj.	Pin No. TSOT-23-5 Fixed	Pin No. TSOT-23-5 Adj.	Pin Name	Pin Function
1	1	3	3	EN	Enable Input. Active High. High = on, low = off. Do not leave floating.
2	2	2	2	GND	Ground
3	3	1	1	VIN	Supply Input.
4	4	5	5	OUT	Output Voltage.
5	–	–	–	NC	No connection.
–	5	–	4	ADJ	Adjust Input. Connect to external resistor voltage divider network.
6	6	4	–	BYP	Reference Bypass: Connect external 0.01μF to GND for reduced Output Noise. May be left open.
HS Pad	HS Pad	–	–	E PAD	Exposed Heatsink Pad connected to ground internally.

Absolute Maximum Ratings⁽¹⁾

Supply Voltage (V_{IN}).....	0V to +6V
Enable Input Voltage (V_{EN}).....	0V to +6V
Power Dissipation, Internally Limited ⁽³⁾	
Lead Temperature (soldering, 3sec).....	260°C
Storage Temperature (T_S).....	-65°C to +150°C

Operating Ratings⁽²⁾

Supply Voltage (V_{IN}).....	+2.3V to +5.5V
Enable Input Voltage (V_{EN}).....	0V to V_{IN}
Junction Temperature (T_J).....	-40°C to +125°C
Junction Thermal Resistance	
MLF-6 (θ_{JA}).....	100°C/W
Thin MLF-6 (θ_{JA}).....	100°C/W
TSOT-23-5 (θ_{JA}).....	235°C/W

Electrical Characteristics⁽⁴⁾

$V_{IN} = V_{OUT} + 1.0V$; $C_{OUT} = 1.0\mu F$; $I_{OUT} = 100\mu A$; $T_J = 25^\circ C$, **bold** values indicate $-40^\circ C$ to $+125^\circ C$, unless noted.

Parameter	Conditions	Min	Typ	Max	Units
Output Voltage Accuracy	Variation from nominal V_{OUT}	-2.0		+2.0	%
	Variation from nominal V_{OUT} ; $-40^\circ C$ to $+125^\circ C$	-3.0		+3.0	%
Line Regulation	$V_{IN} = V_{OUT} + 1V$ to 5.5V; $I_{OUT} = 100\mu A$		0.02	0.3 0.6	%/V %/V
Load Regulation	$I_{OUT} = 100\mu A$ to 150mA		0.15	2.0	%
Dropout Voltage ⁽⁵⁾	$I_{OUT} = 100\mu A$		0.1		mV
	$I_{OUT} = 100mA$		25	75	mV
	$I_{OUT} = 150mA$		40	100	mV
Ground Pin Current	$I_{OUT} = 0$ to 150mA		85	120	μA
Ground Pin Current in Shutdown	$V_{EN} \leq 0.2V$		0.01	2	μA
Ripple Rejection	$f = 1kHz$; $C_{OUT} = 1.0\mu F$; $C_{BYP} = 0.1\mu F$		75		dB
	$f = 20kHz$; $C_{OUT} = 1.0\mu F$; $C_{BYP} = 0.1\mu F$		50		dB
Current Limit	$V_{OUT} = 0V$	275	450	850	mA
Output Voltage Noise	$C_{OUT} = 1.0\mu F$; $C_{BYP} = 0.1\mu F$; 10Hz to 100kHz		30		μV_{RMS}
Enable Input					
Enable Input Voltage	Logic Low			0.2	V
	Logic High	1			V
Enable Input Current	$V_{IL} \leq 0.2V$		0.01	1	μA
	$V_{IH} \geq 1.0V$		0.01	1	μA
Turn-on Time					
Turn-on Time	$C_{OUT} = 1.0\mu F$; $C_{BYP} = 0.1\mu F$		35	100	μs

Notes:

- Exceeding the absolute maximum rating may damage the device.
- The device is not guaranteed to function outside its operating rating.
- The maximum allowable power dissipation of any T_A (ambient temperature) is $P_{D(max)} = (T_{J(max)} - T_A) / \theta_{JA}$. Exceeding the maximum allowable power dissipation will result in excessive die temperature, and the regulator will go into thermal shutdown.
- Specification for packaged product only.
- Dropout voltage is defined as the input-to-output differential at which the output voltage drops 2% below its nominal value measured at 1V differential.

Functional Diagram

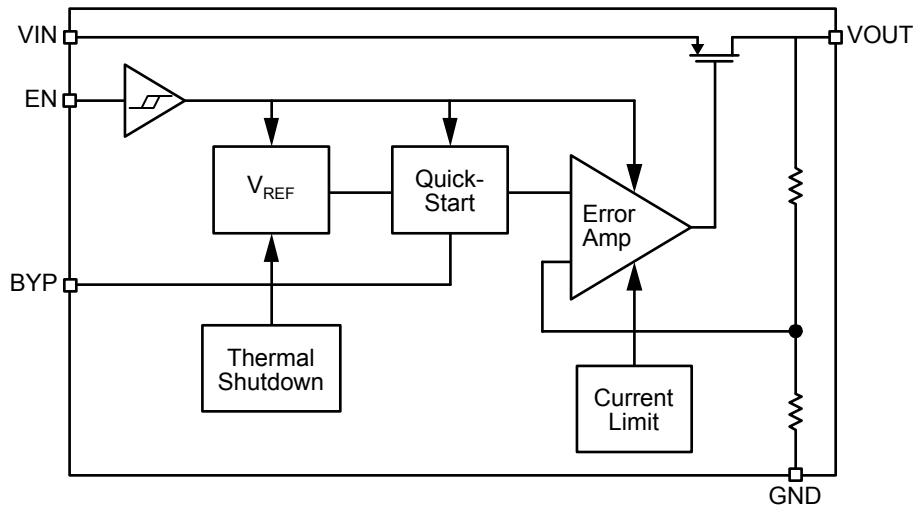

MIC5301 Block Diagram – Fixed

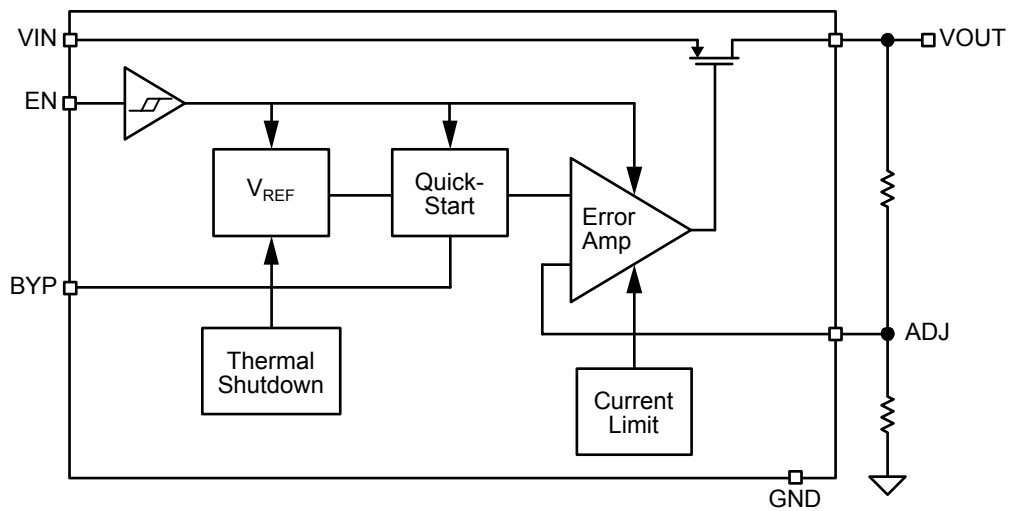

MIC5301 Block Diagram – Adjustable

Typical Characteristics

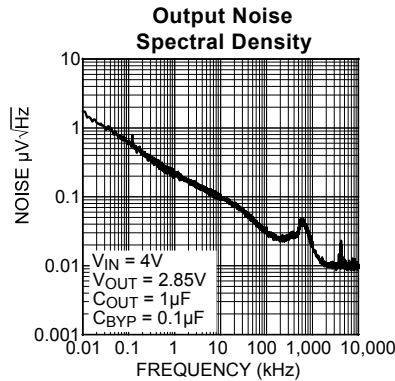
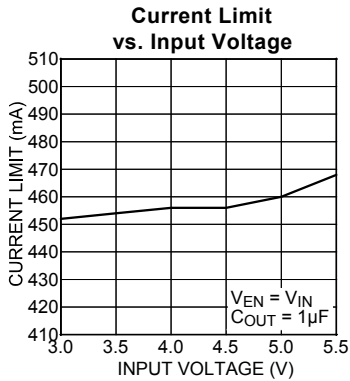
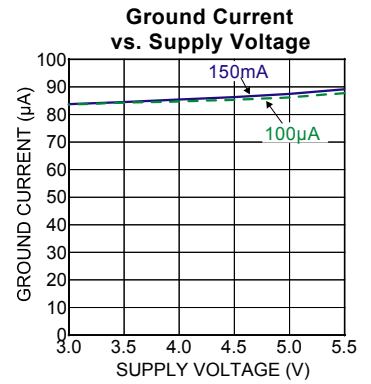
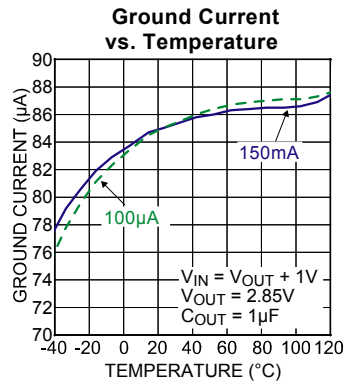
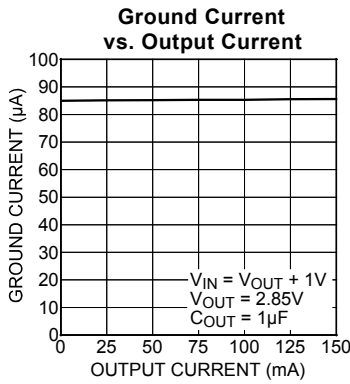
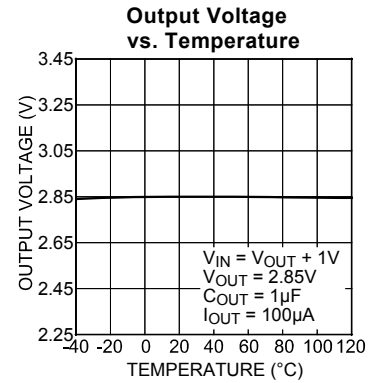
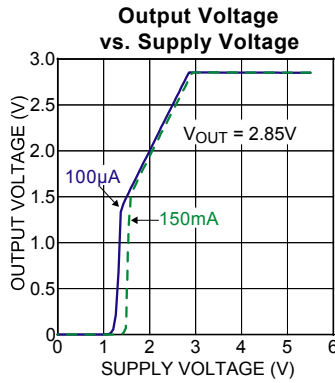
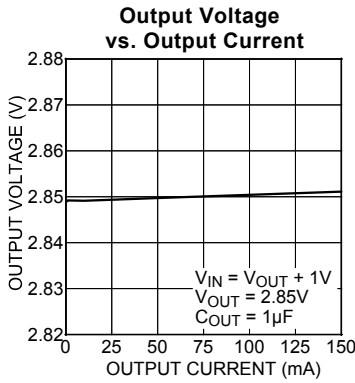
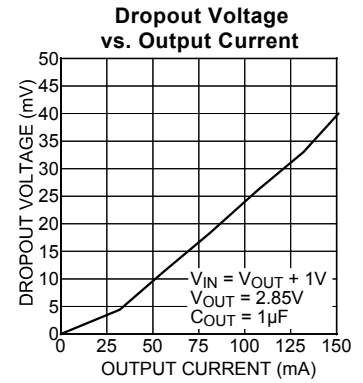
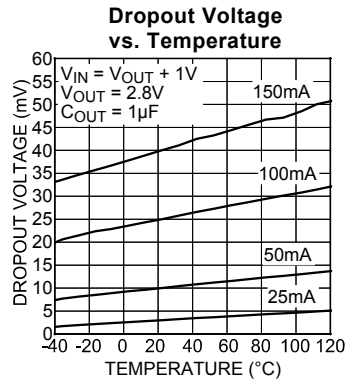
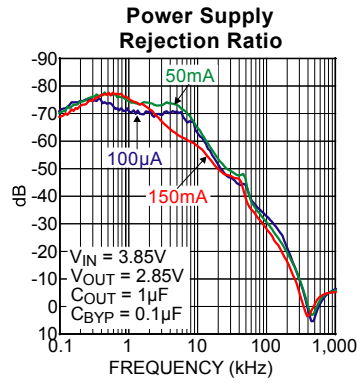

Functional Characteristics

Enable Turn-On

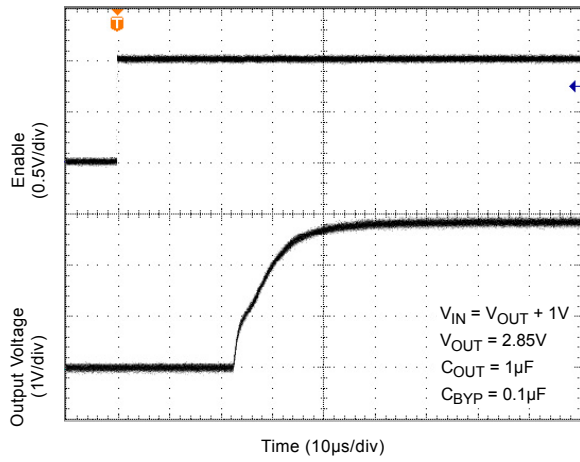

Load Transient

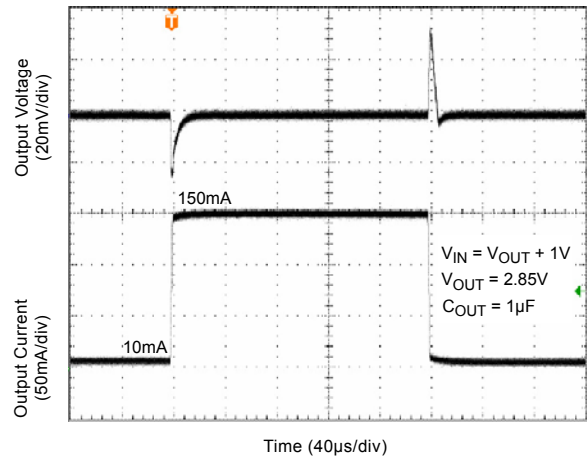

Line Transient

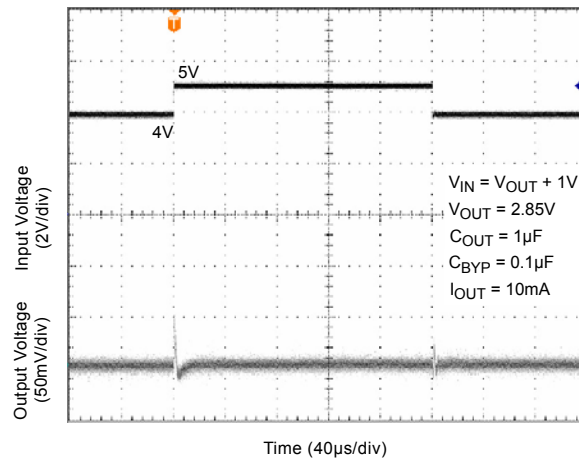

Applications Information

Enable/Shutdown

The MIC5301 comes with an active-high enable pin that allows the regulator to be disabled. Forcing the enable pin low disables the regulator and sends it into a “zero” off-mode-current state. In this state, current consumed by the regulator goes nearly to zero. Forcing the enable pin high enables the output voltage. The active-high enable pin uses CMOS technology and the enable pin cannot be left floating; a floating enable pin may cause an indeterminate state on the output.

Input Capacitor

The MIC5301 is a high-performance, high bandwidth device. Therefore, it requires a well-bypassed input supply for optimal performance. A 1 μ F capacitor is required from the input to ground to provide stability. Low-ESR ceramic capacitors provide optimal performance at a minimum of space. Additional high-frequency capacitors, such as small-valued NPO dielectric-type capacitors, help filter out high-frequency noise and are good practice in any RF-based circuit.

Output Capacitor

The MIC5301 requires an output capacitor of 1 μ F or greater to maintain stability. The design is optimized for use with low-ESR ceramic chip capacitors. High ESR capacitors may cause high frequency oscillation. The output capacitor can be increased, but performance has been optimized for a 1 μ F ceramic output capacitor and does not improve significantly with larger capacitance.

X7R/X5R dielectric-type ceramic capacitors are recommended because of their temperature performance. X7R-type capacitors change capacitance by 15% over their operating temperature range and are the most stable type of ceramic capacitors. Z5U and Y5V dielectric capacitors change value by as much as 50% and 60%, respectively, over their operating temperature ranges. To use a ceramic chip capacitor with Y5V dielectric, the value must be much higher than an X7R ceramic capacitor to ensure the same minimum capacitance over the equivalent operating temperature range.

Bypass Capacitor

A capacitor can be placed from the noise bypass pin to ground to reduce output voltage noise. The capacitor bypasses the internal reference. A 0.1 μ F capacitor is recommended for applications that require low-noise outputs. The bypass capacitor can be increased, further reducing noise and improving

PSRR. Turn-on time increases slightly with respect to bypass capacitance. A unique, quick-start circuit allows the MIC5301 to drive a large capacitor on the bypass pin without significantly slowing turn-on time. Refer to the Typical Characteristics section for performance with different bypass capacitors.

No-Load Stability

Unlike many other voltage regulators, the MIC5301 will remain stable and in regulation with no load. This is especially important in CMOS RAM keep-alive applications.

Adjustable Regulator Application

Adjustable regulators use the ratio of two resistors to multiply the reference voltage to produce the desired output voltage. The MIC5301 can be adjusted from 1.25V to 5.5V by using two external resistors (Figure 1). The resistors set the output voltage based on the following equation:

$$V_{OUT} = V_{REF} \left(1 + \frac{R1}{R2} \right)$$

$$V_{REF} = 1.25V$$

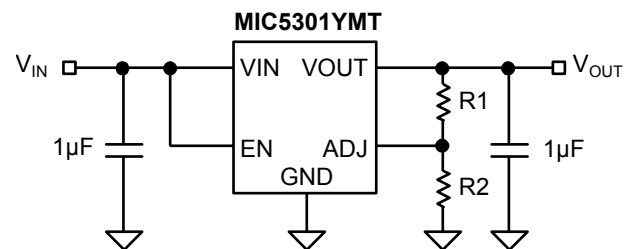

Figure 1. Adjustable Voltage Output

Thermal Considerations

The MIC5301 is designed to provide 150mA of continuous current. Maximum ambient operating temperature can be calculated based on the output current and the voltage drop across the part. Given that the input voltage is 5.0V, the output voltage is 2.8V and the output current = 150mA.

The actual power dissipation of the regulator circuit can be determined using the equation:

$$P_D = (V_{IN} - V_{OUT}) I_{OUT} + V_{IN} I_{GND}$$

Because this device is CMOS and the ground current is typically <100 μ A over the load range, the power dissipation contributed by the ground current is < 1% and can be ignored for this calculation.

$$P_D = (5V - 2.8V) \times 150mA$$

$$P_D = 0.33W$$

To determine the maximum ambient operating temperature of the package, use the junction-to-ambient thermal resistance of the device and the following basic equation:

$$P_{D(MAX)} = \left(\frac{T_{J(MAX)} - T_A}{\theta_{JA}} \right)$$

$T_{J(max)} = 125^{\circ}\text{C}$, the maximum junction temperature of the die θ_{JA} thermal resistance = 100°C/W .

The table below shows junction-to-ambient thermal resistance for the MIC5301 in the 6-pin 1.6mm x 1.6mm MLF[®] package.

Package	θ_{JA} Recommended Minimum Footprint
6-Pin 1.6x1.6 MLF [®]	100°C/W
6-Pin 1.6x1.6 Thin MLF [®]	100°C/W

Thermal Resistance

Substituting P_D for $P_{D(max)}$ and solving for the ambient operating temperature will give the maximum operating conditions for the regulator circuit. The junction-to-ambient thermal resistance for the minimum footprint is 100°C/W .

The maximum power dissipation must not be exceeded for proper operation.

For example, when operating the MIC5301-2.8YML at an input voltage of 5V and 150mA load with a minimum footprint layout, the maximum ambient operating temperature T_A can be determined as follows:

$$0.33\text{W} = (125^{\circ}\text{C} - T_A)/(100^{\circ}\text{C/W})$$

$$T_A = 92^{\circ}\text{C}$$

Therefore, a 2.8V application with 150mA of output current can accept an ambient operating temperature of 92°C in a 1.6mm x 1.6mm MLF[®] package. For a full discussion of heat sinking and thermal effects on voltage regulators, refer to the "Regulator Thermals" section of *Micrel's Designing with Low-Dropout Voltage Regulators* handbook. This information can be found on Micrel's website at:

http://www.micrel.com/_PDF/other/LDOBk_ds.pdf

Package Information

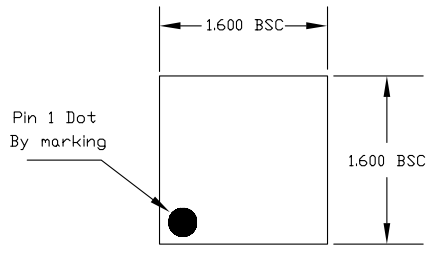

TOP VIEW

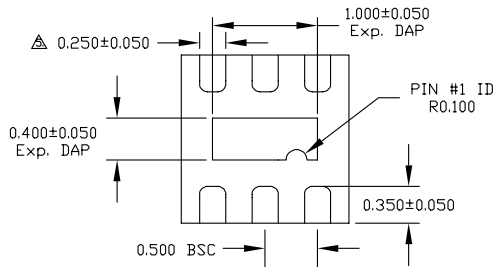

BOTTOM VIEW

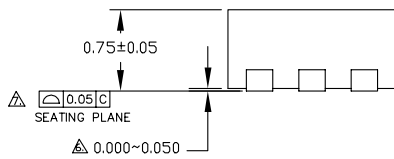

SIDE VIEW

- NOTE:
1. ALL DIMENSIONS ARE IN MILLIMETERS.
 2. MAX. PACKAGE WARPAGE IS 0.05 mm.
 3. MAXIMUM ALLOWABLE BURRS IS 0.076 mm IN ALL DIRECTIONS.
 4. PIN #1 ID ON TOP WILL BE LASER/INK MARKED.
- △ DIMENSION APPLIES TO METALIZED TERMINAL AND IS MEASURED BETWEEN 0.20 AND 0.25 mm FROM TERMINAL TIP.
 △ APPLIED ONLY FOR TERMINALS.
 △ APPLIED FOR EXPOSED PAD AND TERMINALS.

6-Pin 1.6mm x 1.6mm MLF® (ML)

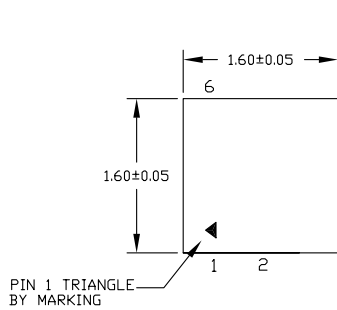

TOP VIEW

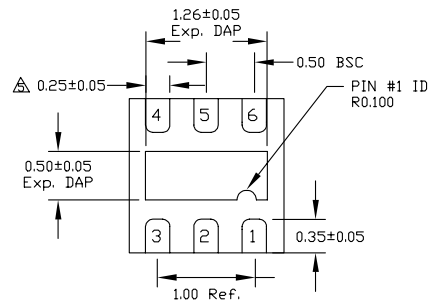

BOTTOM VIEW

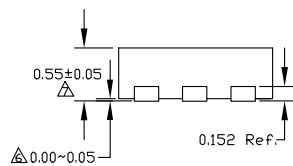

SIDE VIEW

- NOTE:
1. ALL DIMENSIONS ARE IN MILLIMETERS.
 2. MAX. PACKAGE WARPAGE IS 0.05 mm.
 3. MAXIMUM ALLOWABLE BURRS IS 0.076 mm IN ALL DIRECTIONS.
 4. PIN #1 ID ON TOP WILL BE LASER/INK MARKED.
- △ DIMENSION APPLIES TO METALIZED TERMINAL AND IS MEASURED BETWEEN 0.20 AND 0.25 mm FROM TERMINAL TIP.
 △ APPLIED ONLY FOR TERMINALS.
 △ APPLIED FOR EXPOSED PAD AND TERMINALS.

6-Pin 1.6mm x 1.6mm Thin MLF® (MT)

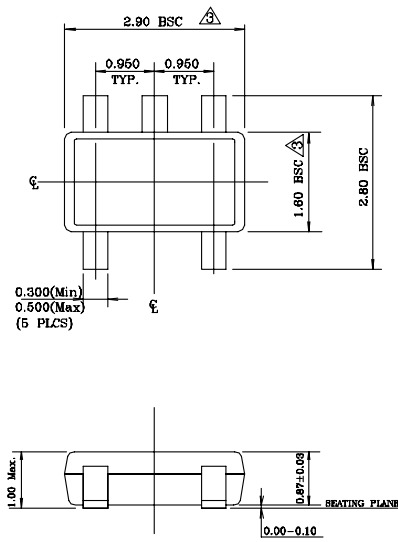

NOTE:

1. Dimensions and tolerances are as per ANSI Y14.5M, 1994.
2. Die is facing up for mold. Die is facing down for trim/form, ie. reverse trim/form.
3. Dimensions are exclusive of mold flash and gate burr.
4. The footlength measuring is based on the gauge plane method.
5. All specification comply to Jedec Spec MO193 Issue C.
6. All dimensions are in millimeters.

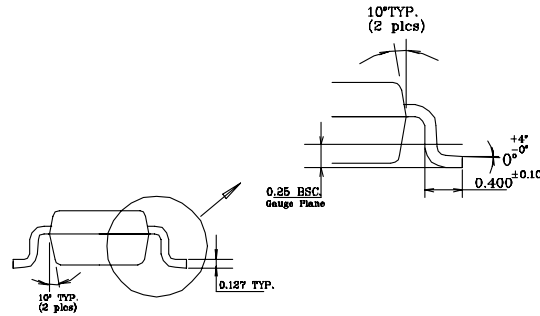

5-Pin TSOT-23 (D5)

MICREL, INC. 2180 FORTUNE DRIVE SAN JOSE, CA 95131 USA
 TEL +1 (408) 944-0800 FAX +1 (408) 474-1000 WEB <http://www.micrel.com>

The information furnished by Micrel in this data sheet is believed to be accurate and reliable. However, no responsibility is assumed by Micrel for its use. Micrel reserves the right to change circuitry and specifications at any time without notification to the customer.

Micrel Products are not designed or authorized for use as components in life support appliances, devices or systems where malfunction of a product can reasonably be expected to result in personal injury. Life support devices or systems are devices or systems that (a) are intended for surgical implant into the body or (b) support or sustain life, and whose failure to perform can be reasonably expected to result in a significant injury to the user. A Purchaser's use or sale of Micrel Products for use in life support appliances, devices or systems is a Purchaser's own risk and Purchaser agrees to fully indemnify Micrel for any damages resulting from such use or sale.

© 2006 Micrel, Inc.

X-ON Electronics

Largest Supplier of Electrical and Electronic Components

Click to view similar products for [LDO Voltage Regulators](#) category:

Click to view products by [Microchip](#) manufacturer:

Other Similar products are found below :

[M38D29FFHP#U1](#) [702103A](#) [717726C](#) [742457H](#) [MP20051DN-LF-Z](#) [R5F111PGGFB#30](#) [AP7363-SP-13](#) [NCP103AMX285TCG](#)
[NCV8664CST33T3G](#) [NCV8752AMX28TCG](#) [L9454](#) [AP7362-HA-7](#) [LX13043CLD](#) [TCR3DF185,LM\(CT](#) [TCR3DF24,LM\(CT](#)
[TCR3DF285,LM\(CT](#) [TCR3DF31,LM\(CT](#) [TCR3DF45,LM\(CT](#) [TLF4949EJ](#) [L9708](#) [L970813TR](#) [030014BB](#) [059985X](#) [EAN61387601](#)
[EAN61573601](#) [NCP121AMX173TCG](#) [NCP4687DH15T1G](#) [NCV8703MX30TCG](#) [701326R](#) [702087BB](#) [755078E](#) [TCR2EN28,LF\(S](#)
[LM1117DT-1.8/NO](#) [LT1086CM#TRPBF](#) [AZ1085S2-1.5TRE1](#) [MAX15101EWL+T](#) [NCV8170AXV250T2G](#) [SCD337BTG](#)
[TCR3DF27,LM\(CT](#) [TCR3DF19,LM\(CT](#) [TCR3DF125,LM\(CT](#) [TCR2EN18,LF\(S](#) [MAX15103EWL+T](#) [TS2937CZ-5.0 C0](#) [MAX8878EUK30-](#)
[T](#) [MAX663CPA](#) [NCV4269CPD50R2G](#) [NCV8716MT30TBG](#) [AZ1117IH-1.2TRG1](#) [MP2013GQ-P](#)