

790-026P
Crimp Terminated Panel Mount Receptacles,
Pin Contacts
How To Order



790-026P Panel Mount Receptacles
PIN CONTACTS WITH CRIMP TERMINATION



790-026P connectors are designed for rear-panel mounting and are supplied with conductive panel gaskets. These connectors feature machined aluminum shells, fluorosilicone face seals and wire grommets for environmental protection. Contacts are rear-release snap-in crimp type. Connectors are supplied with crimp contacts packaged separately. Size #23 signal pins accept up to #22 AWG wire. Size #16 contacts accept #16-18 AWG wire. Size #12 contacts accept #12-14 AWG wire. Size 12 and 16 cavities also accept coaxial contacts purchased separately. Attach optional shielding adapters (799-016) for EMI protection.

HOW TO ORDER

Sample Part Number

790-026P

L-6P6

MT

G

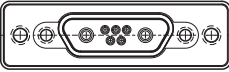
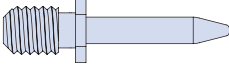
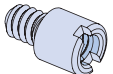
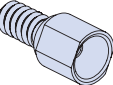
Part Number	Shell Size - Insert Arrangement	Shell Finish	Hardware Option
790-026P Rear Panel Mounted Receptacle with Pin Contacts	See Table 1 for Available Insert Arrangements To order a connector without size #16 or #12 power pins, substitute "W" instead of "P" in the insert arrangement. Example: 36P2 is supplied with 2 power pins. 36W2 is supplied less the power pins. See Section B for coaxial contacts purchased separately.	M Electroless Nickel <i>general purpose applications</i> MT Nickel-PTFE <i>1000 Hour Grey™</i> <i>maximum corrosion protection and durability</i> <i>(non-reflective grey)</i> ZNU Zinc-Nickel with Black Chromate <i>tactical applications</i> <i>(non-reflective black)</i> Additional shell finishes are listed on page C-9.	 N No Hardware  G Guide Pin  P Female Jackpost  S Female Guide Socket

SPECIFICATIONS

Current Rating	#23 5 AMPS, #16 13 A., #12 23 A.
Dielectric Withstanding Voltage	#23 500 VAC RMS, #12 and #16 1800 VAC RMS
Insulation Resistance	5000 megohms minimum
Operating Temperature	-65° C. to +150° C.
Shock	300 g.
Vibration	37 g.

MATERIALS AND FINISHES

Shell	Aluminum alloy
Contacts	Copper alloy, 50 microinches gold plated
Insulators	Liquid crystal polymer (LCP)
Retention Clips	Beryllium copper alloy
Interfacial Seal, Grommet	Flourosilicone rubber
Hardware	300 series stainless steel
Panel Gasket	Fluorosilicone, conductive

Dimensions in Inches (millimeters) are subject to change without notice.



790-026P Crimp Terminated Panel Mount Receptacles, Pin Contacts How To Order

Table 1 Contact Arrangements

Layout	Contact Quantity		Face View
	#23	#16#12	
A-5	5		
B-2P2	2		
B-9	9		
C-13	13		
D-15	15		
D-3P3	3		
D-7P2	5	2	
E-11P2	9	2	
E-19	19		
E-7P3	4	3	
F-15P2	13	2	
F-23	23		
F-5P5	5		
G-33	33		
H-10P4	6	4	
H-29P7	22	7	
H-36P2	34	2	
H-54P2	52	2	
H-5P5		5	
H-66	66		
J-17P4	13	4	
J-25P2	23	2	
J-33	33		
J-7P7	7		
K-27P4	23	4	
K-35P2	33	2	
K-43	43		
K-9P9	9		
L-6P6		6	
L-78	78		
M-102	102		

CROSS-SECTIONAL VIEW OF 790-026P

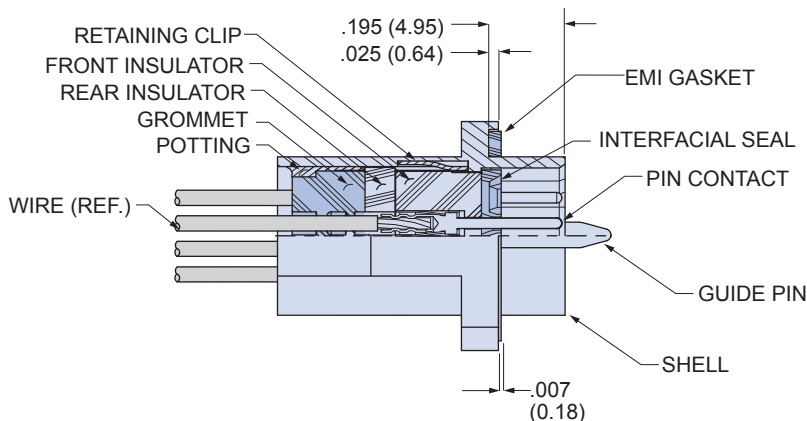
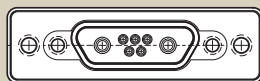

TABLE 2 HARDWARE OPTION



N

No Mating Hardware

Connector is supplied with threaded holes. Shell sizes H and L have #6-32 threads, other sizes have #4-40 threads. Thread depth is .150" (3.8).

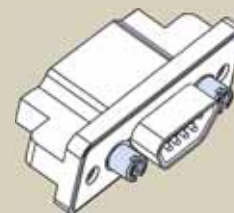

P

Jackposts

Connector is supplied with non-removable stainless steel jackposts. Shell sizes H and L have #4-40 UNC thread, other sizes have #2-56 thread. Stainless steel.

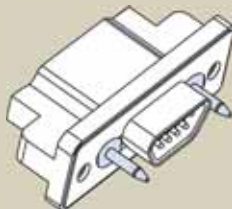

G

Guide Pins

Connector is supplied with stainless steel non-removable guide pins. Mates with type "S" guide sockets on corresponding plug connector.

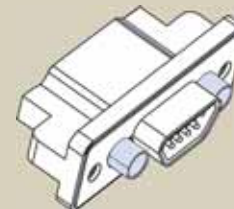

S

Guide Sockets

Connector is supplied with stainless steel non-removable bushings. Mates with type "G" guide pins on corresponding plug connector.

Dimensions in Inches (millimeters) are subject to change without notice.

790-026P
Crimp Terminated Panel Mount Receptacles,
Pin Contacts
Dimensions

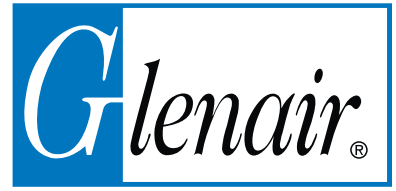

790-026P Shell Size A, B, C, D, E, F, J, K Dimensions

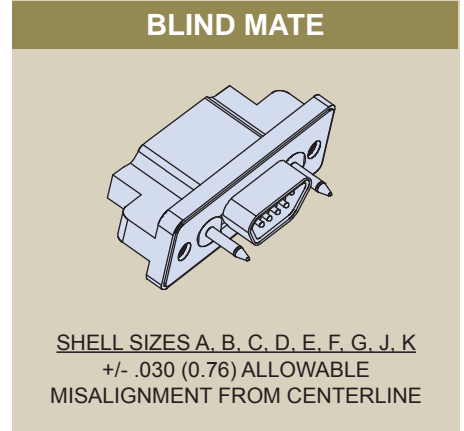
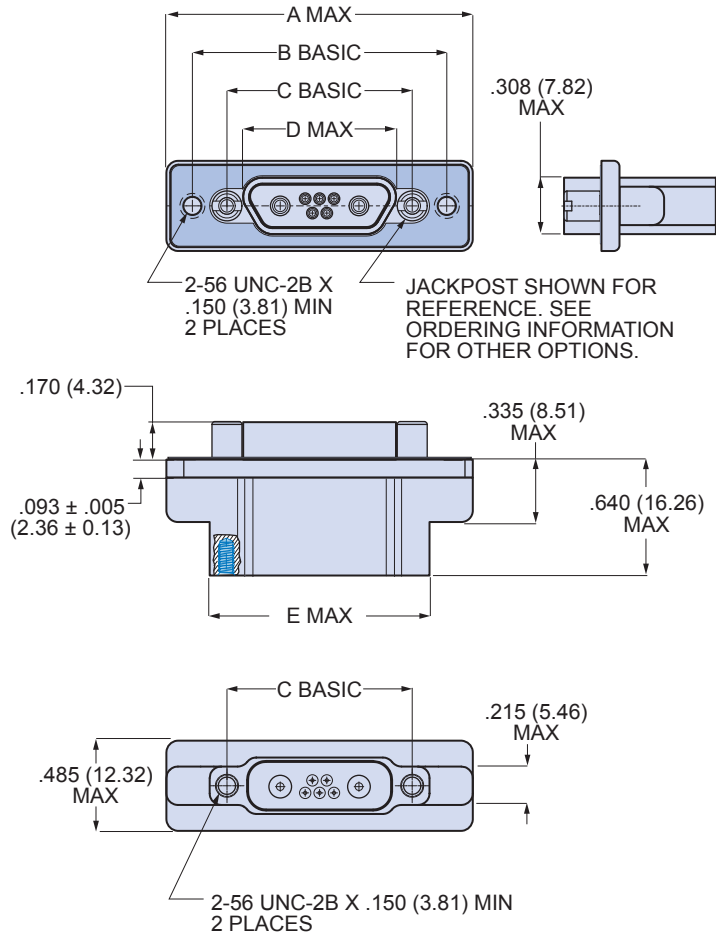

790-026P Dimensions for Size A-F, J and K										
Shell Size	A Max.		B Basic		C Basic		D Max.		E Max.	
	In.	mm.	In.	mm.	In.	mm.	In.	mm.	In.	mm.
A	1.211	30.76	.925	23.50	.565	14.35	.401	10.19	.760	19.30
B	1.361	34.57	1.075	27.31	.715	18.16	.551	14.00	.910	21.11
C	1.511	38.38	1.225	31.12	.865	21.97	.701	17.81	1.060	26.92
D	1.611	40.92	1.325	33.66	.965	24.51	.801	20.35	1.160	29.46
E	1.761	44.73	1.475	37.47	1.115	28.32	.951	24.16	1.310	33.27
F	1.911	48.54	1.625	41.28	1.265	32.13	1.101	27.96	1.460	37.08
J	2.261	57.43	1.975	50.17	1.615	41.02	1.460	37.08	1.810	45.97
K	2.661	67.59	2.375	60.33	2.015	51.18	1.860	47.24	2.210	56.13

Dimensions in Inches (millimeters) are subject to change without notice.



790-026P Crimp Terminated Panel Mount Receptacles, Pin Contacts Dimensions

790-026P Shell Size G Dimensions

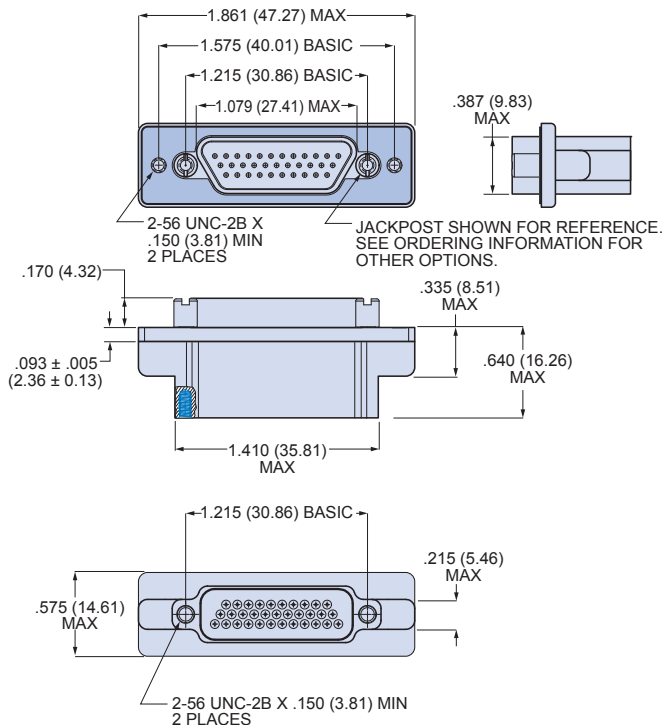

BLIND MATE

SHELL SIZES A, B, C, D, E, F, G, J, K
+/- .030 (0.76) ALLOWABLE
MISALIGNMENT FROM
CENTERLINE

790-026P Shell Size H and L Dimensions

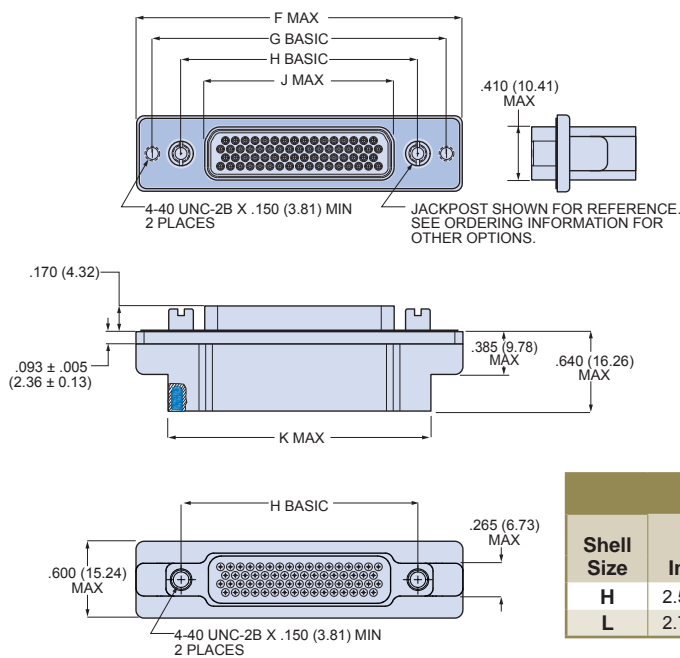

BLIND MATE

SHELL SIZES H, L
+/- .040 (1.02) ALLOWABLE
MISALIGNMENT
FROM CENTERLINE

790-026P SIZE H & L DIMENSIONS										
Shell Size	F Max.		G Basic		H Basic		J Max.		K Max.	
	In.	mm.	In.	mm.	In.	mm.	In.	mm.	In.	mm.
H	2.500	63.50	2.236	56.79	1.800	45.72	1.450	36.83	2.045	51.94
L	2.736	69.49	2.472	62.79	2.036	51.71	1.686	42.82	2.281	57.94

Dimensions in Inches (millimeters) are subject to change without notice.

790-026P
Crimp Terminated Panel Mount Receptacles,
Pin Contacts
Dimensions



790-026P Shell Size M Dimensions

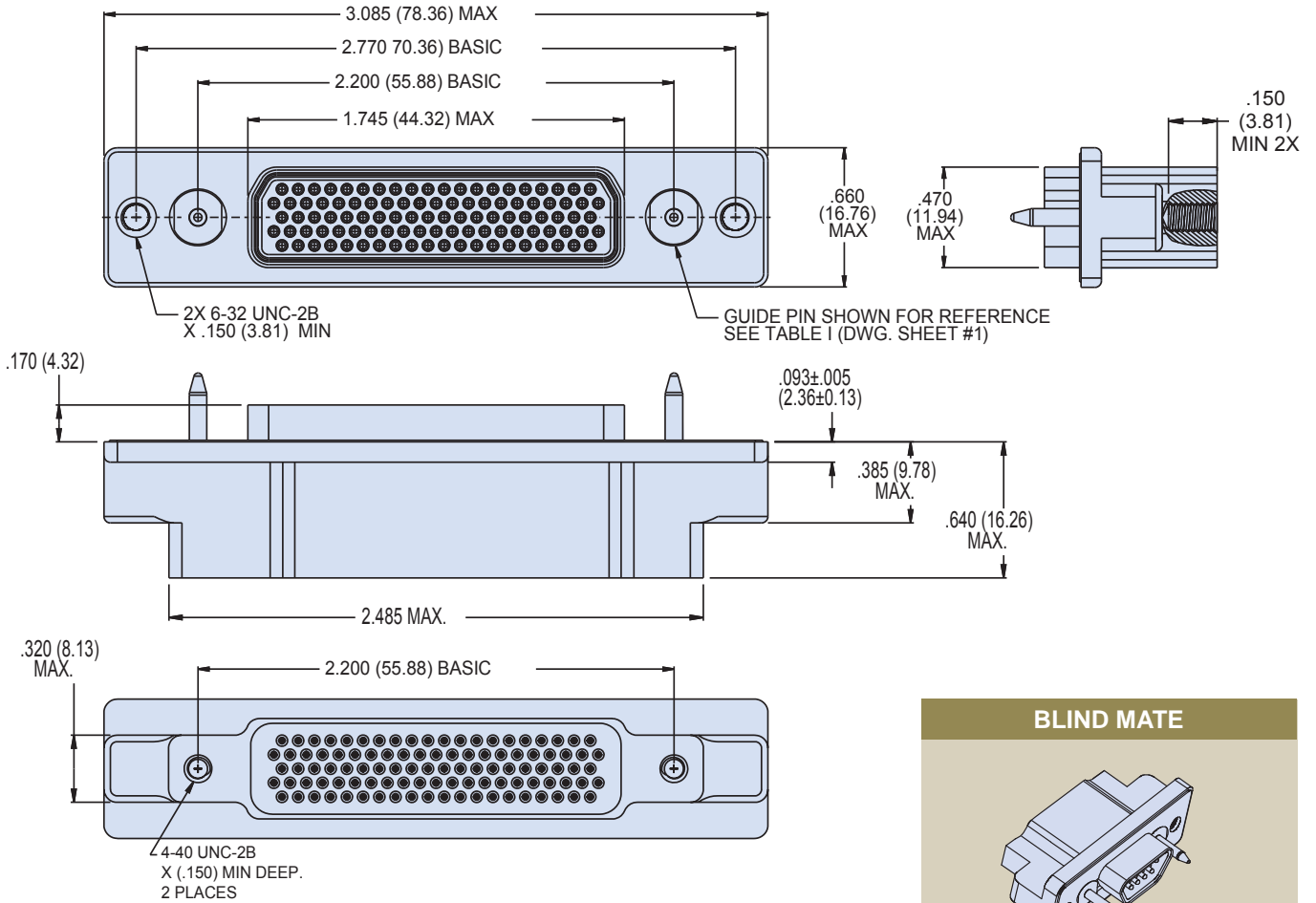

BLIND MATE

SHELL SIZE M
 +/- .050 (0.76) ALLOWABLE
 MISALIGNMENT FROM
 CENTERLINE



Dimensions in Inches (millimeters) are subject to change without notice.

X-ON Electronics

Largest Supplier of Electrical and Electronic Components

Click to view similar products for [D-Sub Micro-D Connectors](#) category:

Click to view products by [Glenair](#) manufacturer:

Other Similar products are found below :

[M243082311F](#) [M2430834F](#) [M24308/4-6F](#) [65-1920-15](#) [M83513/01-HN](#) [M83513/03-A10N](#) [M83513/03-B14C](#) [M83513/03-D09C](#) [M83513/03-D11N](#) [M83513/03-G02N](#) [M83513/03-G05N](#) [M83513/03-G08C](#) [M83513/03-G09N](#) [M83513/03-G12N](#) [M83513/03-H13N](#) [M83513/04-E15N](#) [M83513/04-G04C](#) [M83513/10-E01NP](#) [M83513/13-B01NP](#) [M83513/13-C01NN](#) [M83513/16-A01CP](#) [M83513/22-D01NP](#) [M83513/25-B01NP](#) [6R2004A30F015](#) [6R4006A28A120](#) [703006A13F060](#) [704002A03F200](#) [705001A13F120](#) [7-1532020-5](#) [748567-1-P](#) [MDB1-31SH003](#) [MDM-15PBS-L58](#) [MDM-15PCBRM7T](#) [MDM-15PH003B-A174](#) [75-068624-59S](#) [MDM-15PH034B](#) [MDM-15SH001L](#) [MDM-15SH004B](#) [MDM-21PH003K](#) [MDM-25PH003B-A174](#) [MDM-25PHW01F-A174](#) [MDM-37PH006L-A174](#) [MDM-37PH048M5-A174](#) [MDM-37SCBRP-A174](#) [MDM-51PBS-L56](#) [MDM-51PSF](#) [MDM-51SH003M7](#) [MDM-51SSM7-A174](#) [MDM-9PBSP-L58](#) [MDM-9PH003M7](#)