



#### PANEL PLUGS WITH SOCKET CONTACTS, STRAIGHT PCB TERMINATION, 790-029S



Lightweight, rugged vertical mount headers feature gold-plated PC tail contacts for thru-hole printed circuit board termination. 790-029S connectors are designed for rear-panel mounting and are supplied with conductive panel gaskets. Contacts are permanently installed and are sealed with epoxy. Shells are aluminum alloy. Threaded board mounting holes and integral standoffs simplify installation. Available in 29 different contact arrangements, these connectors feature size #23 signal contacts along with #16 and #12 power contacts for up to 23 amps current rating. Optional EMI spring improves shell-to-shell conductivity and shielding performance. Stainless steel jackposts are non-removable.

#### HOW TO ORDER

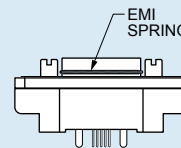
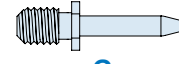
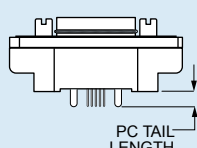
##### Sample Part Number

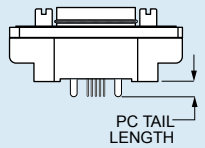
790-029S	K-43	M	E	P	B
Part Number	Shell Size - Insert Arr.	Shell Finish	EMI Spring	Hardware Option	PC Tail Length
<b>790-029S</b> Rear Panel Mounted Plug with Straight PC Tail Contacts for Termination to Backplanes or Flexible Circuits	See Table 1 for Available Insert Arrangements	<b>M</b> Electroless Nickel <i>general purpose applications</i>  <b>MT</b> Nickel-PTFE <i>1000 Hour Grey™ maximum corrosion protection and durability (non-reflective grey)</i>  <b>ZNU</b> Zinc-Nickel with Black Chromate <i>tactical applications (non-reflective black)</i>  Additional shell finishes are listed on page C-9.	<b>E</b> EMI Spring  <b>N</b> No Spring  	 <b>N</b> No Hardware   <b>G</b> Guide Pin   <b>P</b> Female Jackpost   <b>S</b> Female Guide Socket	<b>A</b> .125 Inch (3.2 mm.)  <b>B</b> .250 inch (6.4 mm.)  

#### SPECIFICATIONS

Current Rating	#23 5 AMPS, #16 13 A., #12 23 A.
Dielectric Withstanding Voltage	#23 500 VAC RMS, #12 and #16 1800 VAC RMS
Insulation Resistance	5000 megohms minimum
Operating Temperature	-65° C. to +150° C.
Shock	300 g.
Vibration	37 g.

#### MATERIALS AND FINISHES

Shell	Aluminum alloy
Contacts	Copper alloy, 50 microinches gold plated, with stainless steel hoods
Insulator	Liquid crystal polymer (LCP)
Hardware	300 series stainless steel
Panel Gasket	Fluorosilicone, conductive
Encapsulant	Epoxy

Dimensions in inches (millimeters) and are subject to change without notice.

# Series 79 Micro-Crimp

## Section F: Straight Printed Circuit Board Connectors



**Table 1 Contact Arrangements**

Layout	Contact Quantity		Face View
	#23	#16#12	
A-5	5		
B-2P2	2		
B-9	9		
C-13	13		
D-15	15		
D-3P3	3		
D-7P2	5	2	
E-11P2	9	2	
E-19	19		
E-7P3	4	3	
F-15P2	13	2	
F-23	23		
F-5P5	5		
G-33	33		
H-10P4	6	4	
H-29P7	22	7	
H-36P2	34	2	
H-54P2	52	2	
H-5P5		5	
H-66	66		
J-17P4	13	4	
J-25P2	23	2	
J-33	33		
J-7P7	7		
K-27P4	23	4	
K-35P2	33	2	
K-43	43		
K-9P9	9		
L-6P6		6	

**CROSS-SECTIONAL VIEW OF 790-029S**

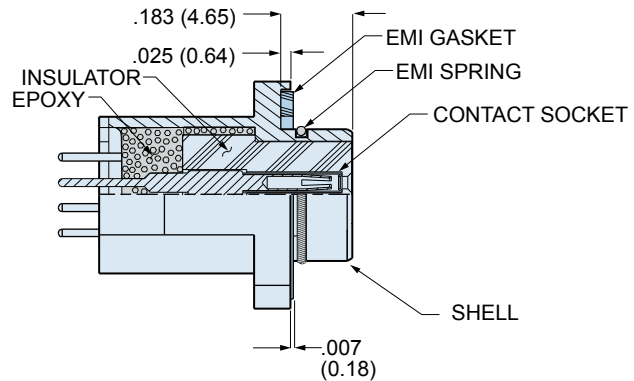

**TABLE 2 HARDWARE OPTION**

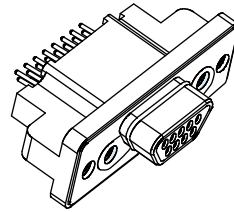

**N**

**No Mating Hardware**

Connector is supplied with threaded holes. Shell sizes H and L have #6-32 threads, other sizes have #4-40 threads. Thread depth is .150" (3.8).

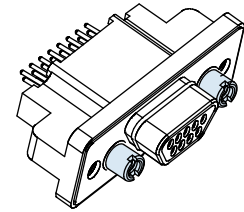

**P**

**Jackposts**

Connector is supplied with non-removable stainless steel jackposts. Shell sizes H and L have #4-40 UNC thread, other sizes have #2-56 thread.

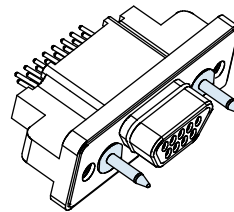

**G**

**Guide Pins**

Connector is supplied with stainless steel non-removable guide pins. Mates with type "S" guide sockets on corresponding receptacle connector.

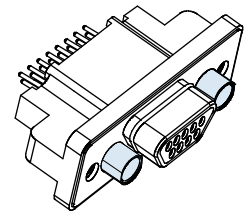

**S**

**Guide Sockets**

Connector is supplied with stainless steel non-removable bushings. Mates with type "G" guide pins on corresponding receptacle connector.

Dimensions in inches (millimeters) and are subject to change without notice.

### 790-029S SHELL SIZE A,B,C,D,E,F,J,K DIMENSIONS

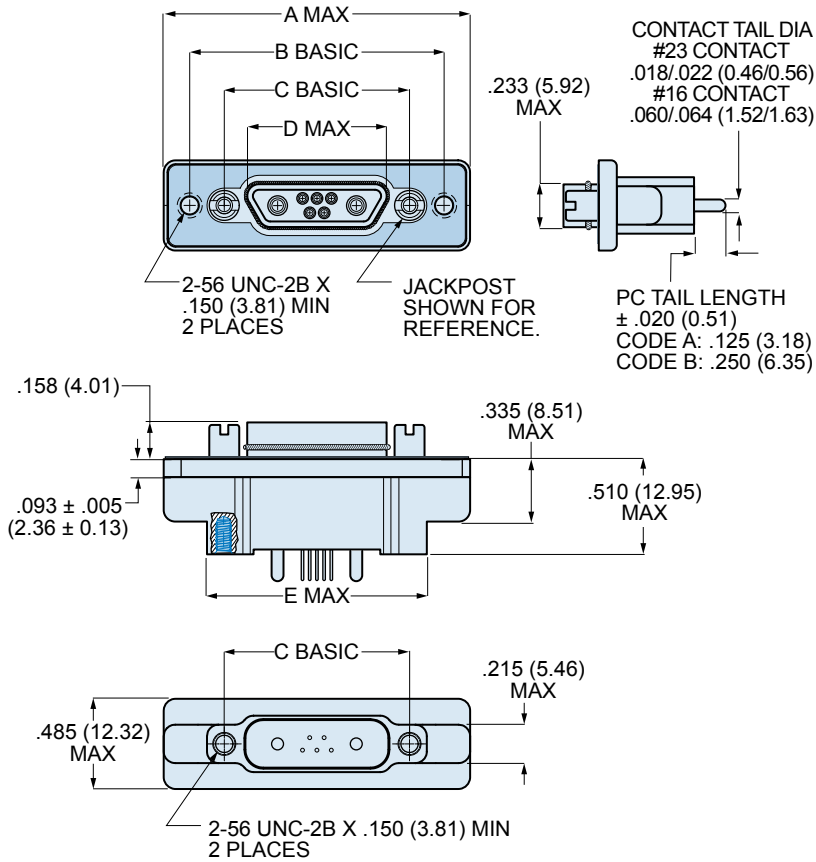

### BLIND MATE

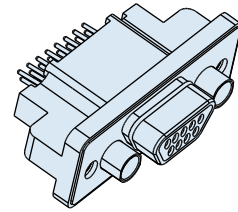

SHELL SIZES A, B, C, D, E, F, G, J, K  
 +/- .030 (0.76) ALLOWABLE  
 MISALIGNMENT FROM CENTERLINE

### 790-029S SIZE A-F, J, K DIMENSIONS

Shell Size	A Max.		B Basic		C Basic		D Max.		E Max.	
	In.	mm.	In.	mm.	In.	mm.	In.	mm.	In.	mm.
<b>A</b>	1.211	30.76	.925	23.50	.565	14.35	.335	8.51	.760	19.30
<b>B</b>	1.361	34.57	1.075	27.31	.715	18.16	.485	12.32	.910	21.11
<b>C</b>	1.511	38.38	1.225	31.12	.865	21.97	.635	16.13	1.060	26.92
<b>D</b>	1.611	40.92	1.325	33.66	.965	24.51	.735	18.67	1.160	29.46
<b>E</b>	1.761	44.73	1.475	37.47	1.115	28.32	.885	22.48	1.310	33.27
<b>F</b>	1.911	48.54	1.625	41.28	1.265	32.13	1.035	26.29	1.460	37.08
<b>J</b>	2.261	57.43	1.975	50.17	1.615	41.02	1.390	35.31	1.810	45.97
<b>K</b>	2.661	67.59	2.375	60.33	2.015	51.18	1.795	45.59	2.210	56.13

Dimensions in inches (millimeters) and are subject to change without notice.

# Series 79 Micro-Crimp Section F: Straight Printed Circuit Board Connectors



## 790-029S SHELL SIZE G DIMENSIONS

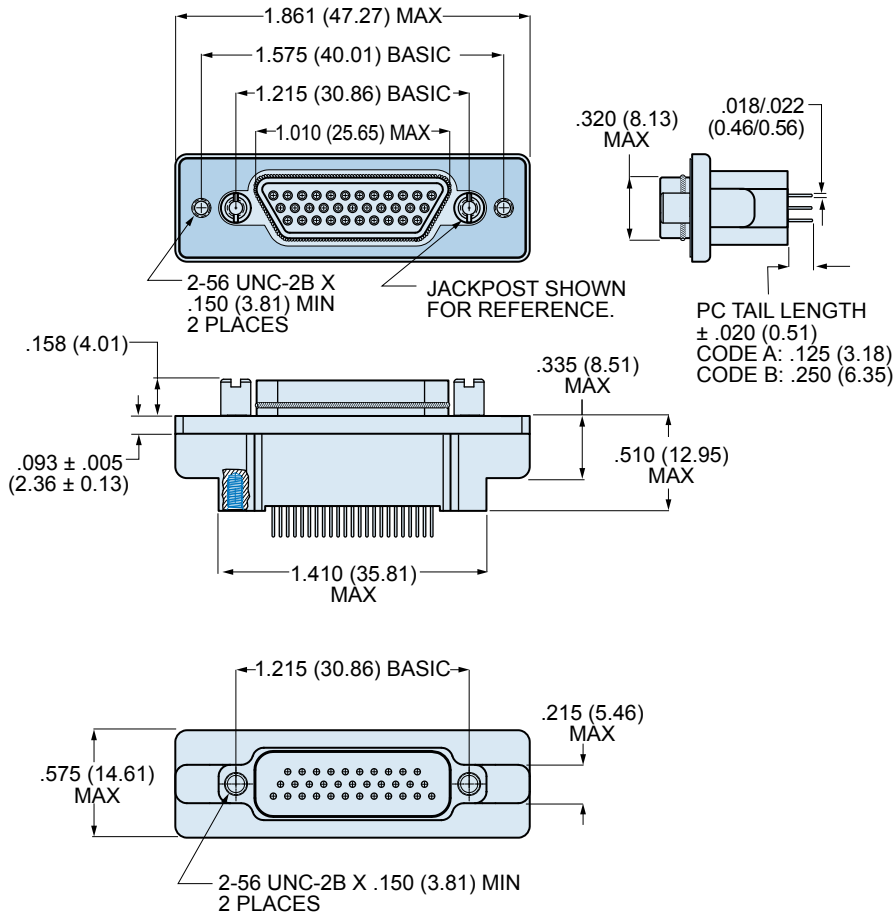

### BLIND MATE

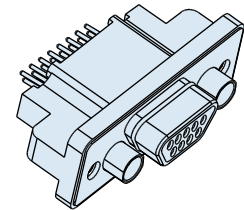

SHELL SIZES A, B, C, D, E, F, G, J, K  
+/- .030 (0.76) ALLOWABLE  
MISALIGNMENT FROM CENTERLINE

Dimensions in inches (millimeters) and are subject to change without notice.

790-029S SHELL SIZE H AND L DIMENSIONS

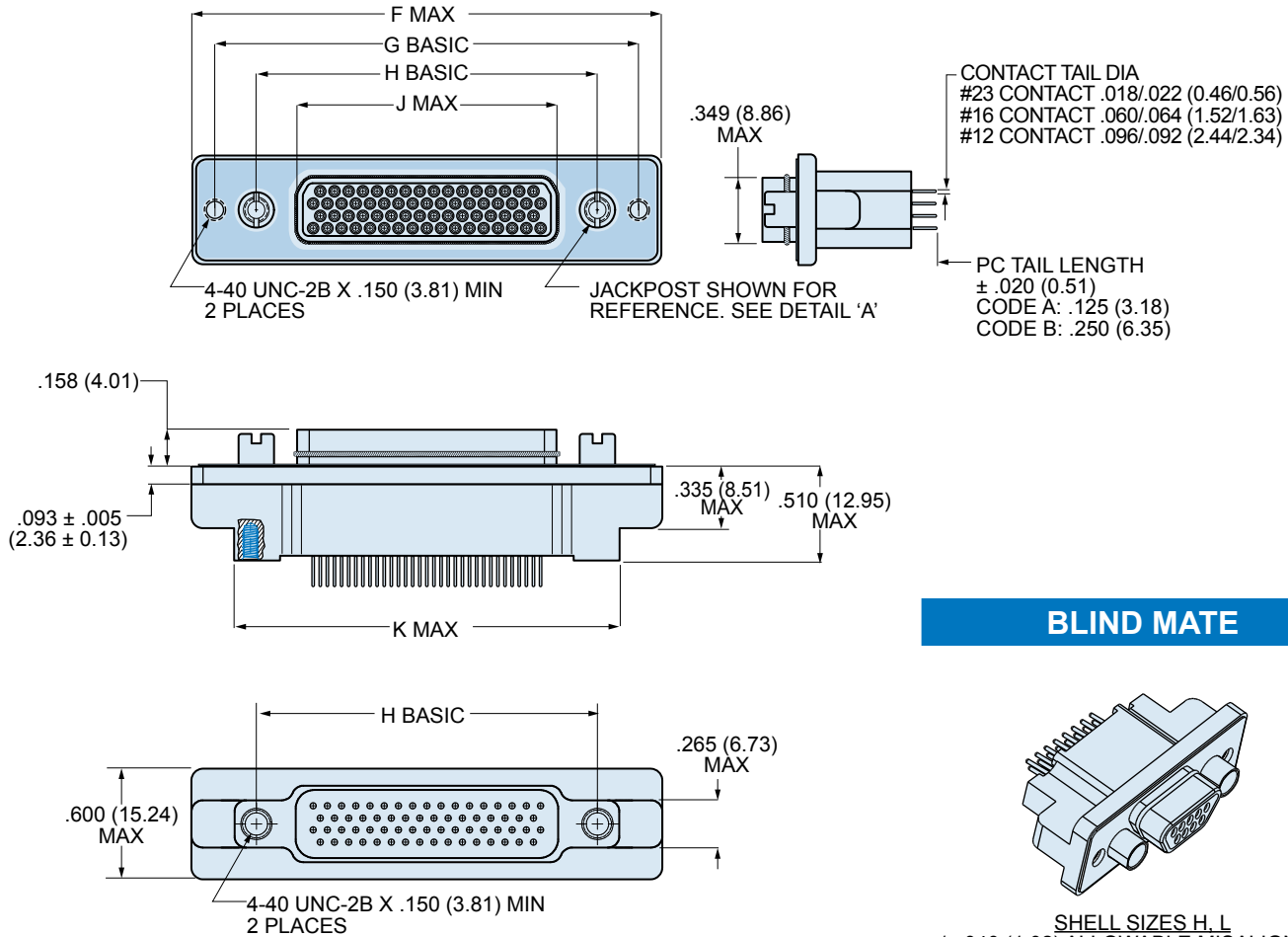

BLIND MATE

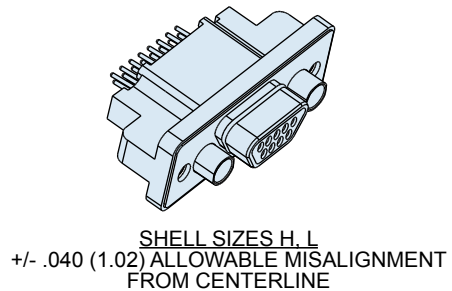

790-029S SIZE H & L DIMENSIONS

Shell Size	F Max.		G Basic		H Basic		J Max.		K Max.	
	In.	mm.	In.	mm.	In.	mm.	In.	mm.	In.	mm.
H	2.500	63.50	2.236	56.79	1.800	45.72	1.385	35.18	2.045	51.94
L	2.736	69.49	2.472	62.79	2.036	51.71	1.623	41.22	2.281	57.94

Dimensions in inches (millimeters) and are subject to change without notice.

# Series 79 Micro-Crimp Section F: Straight Printed Circuit Board Connectors



## PCB Hole Patterns for 790-029S and 790-044S Plugs

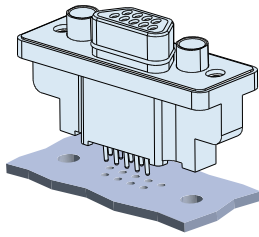

This section contains printed circuit board footprints for vertical mounted Series 79 plugs. The contact identification numbers are shown for the connector mounting side of the PC board. Contact tails are gold over nickel plated.

Contact Size	PC Tail Diameter	
	In.	Ø Diameter mm.
#23	.018-.022	0.46-0.56
#16	.060-.064	1.52-1.63
#12	.092-.096	2.34-2.44

### 790-029S AND 790-044S PRINTED CIRCUIT BOARD PATTERNS

Insert Arr.	Component Mounting Side of PCB
A-5	
B-2P2	
B-9	
C-13	

Dimensions in inches (millimeters) and are subject to change without notice.

790-029S AND 790-044S PRINTED CIRCUIT BOARD PATTERNS

Insert Arr.	Component Mounting Side of PCB
D-15	
D-3P3	
D-7P2	
E-11P2	
E-19	

Dimensions in inches (millimeters) and are subject to change without notice.

# Series 79 Micro-Crimp Section F: Straight Printed Circuit Board Connectors



## 790-029S AND 790-044S PRINTED CIRCUIT BOARD PATTERNS

Insert Arr.	Component Mounting Side of PCB
E-7P3	
F-15P2	
F-23	
F-5P5	
G-33	

Dimensions in inches (millimeters) and are subject to change without notice.



790-029S AND 790-044S PRINTED CIRCUIT BOARD PATTERNS

Insert Arr.	Component Mounting Side of PCB
H-10P4	
H-29P7	
H-36P2	
H-54P2	
H-5P5	

Dimensions in inches (millimeters) and are subject to change without notice.

# Series 79 Micro-Crimp Section F: Straight Printed Circuit Board Connectors



## 790-029S AND 790-044S PRINTED CIRCUIT BOARD PATTERNS

Insert Arr.	Component Mounting Side of PCB
H-66	
J-17P4	
J-25P2	
J-33	
J-7P7	

Dimensions in inches (millimeters) and are subject to change without notice.

790-029S AND 790-044S PRINTED CIRCUIT BOARD PATTERNS

Insert Arr.	Component Mounting Side of PCB
K-27P4	<p>Dimensions: .595 (15.11), .4325 (10.99), .2575 (6.54), 2.015 (51.18), .0375 (0.95) TYP, .075 (1.91) TYP, 1.150 (29.21), 1.500 (38.1), .0325 (0.83) TYP, .065 (1.65) TYP.</p> <p>Notes: (HOLE TO ACCEPT .022 (0.56) MAX DIA CONTACT 23x), (HOLE TO ACCEPT .064 (1.63) MAX DIA CONTACT 4x), <math>\varnothing .003</math> (M) (A) (M).</p>
K-35P2	<p>Dimensions: .2575 (6.54), .4075 (10.35), 2.015 (51.18), .075 (1.91) TYP, .0375 (0.95) TYP, 1.500 (38.1), .0325 (0.83) TYP, .065 (1.65) TYP.</p> <p>Notes: (HOLE TO ACCEPT .022 (0.56) MAX DIA CONTACT 33x), (HOLE TO ACCEPT .064 (1.63) MAX DIA CONTACT 2x), <math>\varnothing .003</math> (M) (A) (M).</p>
K-43	<p>Dimensions: .220 (5.59), 2.015 (51.18), .075 (1.91) TYP, .0375 (0.95) TYP, .065 (1.65) TYP, .0325 (0.83) TYP.</p> <p>Notes: (HOLE TO ACCEPT .022 (0.56) MAX DIA CONTACT 43x), <math>\varnothing .003</math> (M) (A) (M).</p>
K-9P9	<p>Dimensions: .3075 (7.81), .175 (4.45), 2.015 (51.18).</p> <p>Notes: (HOLE TO ACCEPT .064 (1.63) MAX DIA CONTACT 9), <math>\varnothing .003</math> (M) (A) (M).</p>
L-6P6	<p>Dimensions: .428 (10.87), .236 (5.99) 5x, 2.036 (51.71).</p> <p>Notes: (HOLE TO ACCEPT .096 (2.44) MAX DIA CONTACT 6x), <math>\varnothing .003</math> (M) (A) (M).</p>

Dimensions in inches (millimeters) and are subject to change without notice.

## X-ON Electronics

Largest Supplier of Electrical and Electronic Components

*Click to view similar products for [D-Sub Micro-D Connectors](#) category:*

*Click to view products by [Glenair](#) manufacturer:*

Other Similar products are found below :

[M243082311F](#) [M2430834F](#) [M24308/4-6F](#) [65-1920-15](#) [M83513/01-HN](#) [M83513/03-A10N](#) [M83513/03-B14C](#) [M83513/03-D09C](#) [M83513/03-D11N](#) [M83513/03-G02N](#) [M83513/03-G05N](#) [M83513/03-G08C](#) [M83513/03-G09N](#) [M83513/03-G12N](#) [M83513/03-H13N](#) [M83513/04-E15N](#) [M83513/04-G04C](#) [M83513/10-E01NP](#) [M83513/13-B01NP](#) [M83513/13-C01NN](#) [M83513/16-A01CP](#) [M83513/22-D01NP](#) [M83513/25-B01NP](#) [6R2004A30F015](#) [6R4006A28A120](#) [703006A13F060](#) [704002A03F200](#) [705001A13F120](#) [7-1532020-5](#) [748567-1-P](#) [MDB1-31SH003](#) [MDM-15PBS-L58](#) [MDM-15PCBRM7T](#) [MDM-15PH003B-A174](#) [75-068624-59S](#) [MDM-15PH034B](#) [MDM-15SH001L](#) [MDM-15SH004B](#) [MDM-21PH003K](#) [MDM-25PH003B-A174](#) [MDM-25PHW01F-A174](#) [MDM-37PH006L-A174](#) [MDM-37PH048M5-A174](#) [MDM-37SCBRP-A174](#) [MDM-51PBS-L56](#) [MDM-51PSF](#) [MDM-51SH003M7](#) [MDM-51SSM7-A174](#) [MDM-9PBSP-L58](#) [MDM-9PH003M7](#)