

ZK2.5-S PI-Spring Terminal Blocks Disconnect with blade - with test sockets

Combine high performance with compact dimensions: 630 V IEC 300 V UL. (I)Secure the current measurement:

- for currents below 50 mA, thanks to 2 built in test points DIA 2 mm 0,079 in,
- for currents up to 16 A, by using the TP4 test adapter inserted into the jumper channels.

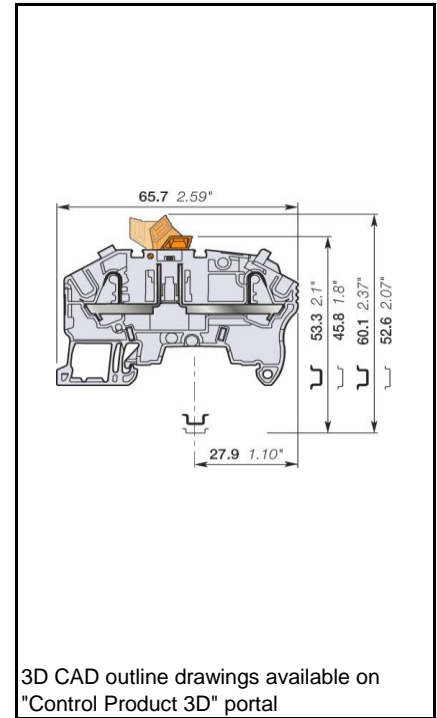
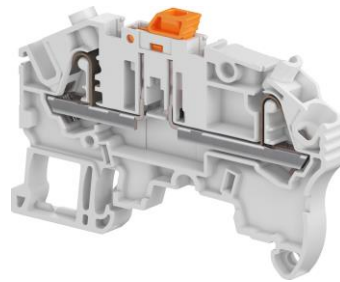

	PI-Spring Terminal Blocks	2,5 mm ²
		12 AWG
5,2 mm 0,205 in Spacing		







Ordering Details

Color	Type	Order Code	EAN Code	Pack ^(ing)	Weight (1 pce)	g
Grey	ZK2.5-S	1SNK705310R0000	3472597053108	50		8,1
Blue	ZK2.5-S-BL	1SNK705320R0000	3472597053207	50		8,1
Orange	ZK2.5-S-OR	1SNK705330R0000	3472597053306	50		8,1

Declarations and Certificates



		RoHS							
CE	CB	RoHS	US	USR	CNR				
		BV							

Declarations and Certificates

	CE	1SND225150C10*
	CB	1SND162019A02*
	RoHs	1SND230535F02*
	USR CNR	1SND162012A02*
	CSA	1SND162014A02*
	GOST R	1SND161005A11*
	BV	1SND162013A02*

General Information

The following information must be strictly adhered to in order to guarantee the terminal block electrical, mechanical and environmental performance.

Protection	IEC 60947-1	IP20		NEMA 1			
Rail	TH35-7.5, TH35-15	TH35-7.5, TH35-15					
Wire stripping length		11 mm	0,433 in				
		Screw clamp		Screw rail contact (Maximum value)		Disconnect device	
Operating tool		Flat screwdriver					
		3,5 mm	0,138 in				
Torque							

Material Specifications

Insulating material	Polyamide
CTI	600 V
Flammability	UL94 V0
	NF F 16101 I2F2
	Needle flame test: C 60615-11-5 Compliant

Connecting capacity per clamp

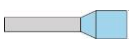
		PI Spring		
1 Rigid - Solid / Stranded conductor	Norme	IEC60947-7-1	UL1059	
	Value	0.2 ... 4 mm ²	26 ... 12 AWG	
1 Flexible conductor	Norme	IEC60947-7-1		
	Value	0.22 ... 2.5 mm ²		
1 Flexible conductor with non insulated ferrule	Norme	Manufacturer data	Manufacturer data	
	Value	0.22 ... 2.5 mm ²	26 ... 14 AWG	
1 Flexible conductor with insulated ferrule	Norme	Manufacturer data	Manufacturer data	
	Value	0.22 ... 2.5 mm ²	26 ... 14 AWG	
Gauge			2,4 mm	
		IEC 60947-1		
Ferrule maximum outer diameter or conductor insulation maximum outer diameter		∅ Max.	Manufacturer data	4,65 mm

The "Connecting capacity with ferrule" data is guaranteed with ABB crimping tool PS-3 (crimping capacity up to 10 mm²).

As part of its on-going product improvement, ABB reserves the right to modify the characteristics or the products described in this document. The information given is not contractual. For further details please contact the ABB company marketing these products in your country.

Multi Connecting capacity per clamp

2 Rigid - Solid / Stranded conductors	Norme			
	Value			
2 Flexible conductors	Norme			
	Value			
2 Flexible conductors with twin ferrule	Norme	Manufacturer data	Manufacturer data	
	Value	0.22 ... 0.5 mm ²	26 ... 20 AWG	

Don't mix **solid and flexible** conductors **in the same clamp**

Don't mix **solid or flexible** conductors of different sizes **in the same clamp**

The "Connecting capacity with ferrule" data is guaranteed with ABB crimping tool PS-3 (crimping capacity up to 10 mm²)

Cross section

Rated cross section	IEC60947-7-1	2,5 mm ²	UL1059	12 AWG
Maximum Cross section	Manufacturer data		Manufacturer data	12 AWG

Electrical characteristics

Current

Rated current		IEC60947-7-1	20 A
	Field and factory wiring Cat.2	UL 1059	20 A
	Factory wiring Cat.1	UL 1059	
		CSA-C-22.2 n°158	14 A
Maximum Exe current		IEC/EN 60079-7	
Rated short-time withstand current 1 s (I _{cw})		IEC60947-7-1	300 A
Short-time withstand current	0.5 s	Manufacturer data	
	5 s	Manufacturer data	
	10 s	Manufacturer data	
	30 s	Manufacturer data	
	1 min	Manufacturer data	
Rated short-circuit withstand current		UL 1059	396 A
Max. current (45° temperature increase) / Max. cross section (mm ²)		Manufacturer data	
Maximum short circuit current (1s)		Manufacturer data	300 A

Short Circuit Current Rating (SCCR) SA UL 1059 supplement

SCCR	UL 1059
With the following configurations:	
Suitable conductor wire range	
Maximum voltage	
Fuse class / Max. amp. Rating	J
	T
	RK1
	RK5
	G
	CC

Voltage

Rated voltage	IEC 60947-1	630 V
Rated voltage	UL 1059	300 V
Use Group	UL 1059	B, C
Rated voltage	CSA-C-22.2 n°158	300 V
Rated voltage Ex e	IEC/ EN 60079-7	
Rated impulse withstand voltage	IEC 60947-1	6000 V
Dielectric test voltage	IEC 60947-1	
Pollution degree	IEC 60947-1	3
Overvoltage category	IEC 60947-1	III

Temperature range

Ambient temperature min/max	Storage	-55 ... +110 °C	-67 ... +230 °F
	Installing	-5 ... +40 °C	-23 ... +104 °F
	Service	-55 ... +110 °C	-67 ... +230 °F

Current Derating curve for continuous service temperature

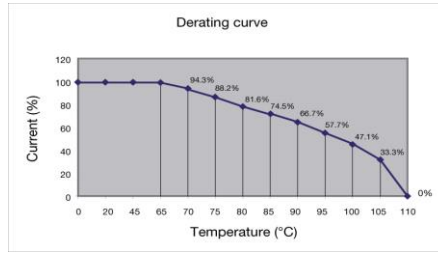

Dissipated power

Maximum dissipated power at rated current	IEC 60947-1	1,6 W
Maximum dissipated power at maximum Exe current	IEC 60079-7	

Rated power dissipation at an ambient temperature of 23 °C - IEC 60947-7-3

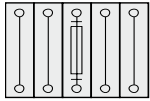
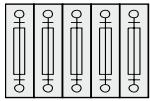
Separate arrangement / Overload and short-circuit protection	 <p>1 fuse and 4 feed-through blocks</p>	
Separate arrangement / Exclusive short-circuit protection		
Compound arrangement / Overload and short-circuit protection	 <p>5 fuse blocks</p>	
Compound arrangement / Exclusive short-circuit protection		

Environmental Characteristics Additional climatic tests

Dry heat	Conditions	IEC 60068-2 2	Compliant
		Temperature	110 °C
		Duration of test	96 h
Cyclic damp heat	Conditions	IEC 60068-2 30	Compliant
		Temperature	55 °C
		Relative humidity	95 %
		Number of cycles (1 cycle = 24h)	2
Cold	Conditions	IEC 60068-2 1	Compliant
		Temperature	-55 °C
		Duration of test	96 h
Damp heat steady state	Conditions	IEC 60068-2-78	Compliant
		Temperature	40 °C
		Relative humidity	93 %
		Duration of test	96 h

Corrosion

Salt mist	Conditions	IEC 60068-2 11	Compliant
		Duration of test	1000 h
		Concentration	5 %
SO ₂	Conditions	ISO 6988	Compliant
		Duration of test	48 h
		Concentration	0,2 dm ³
Flowing mixed gas corrosion test	Conditions	IEC 60068-2 60	Compliant
		Number of the test method	3
		Duration of test	21 j

As part of its on-going product improvement, ABB reserves the right to modify the characteristics or the products described in this document. The information given is not contractual. For further details please contact the ABB company marketing these products in your country.

Contact us

ABB France
Low Voltage Products Division
Export Department
10, rue Ampère Z.I. - B.P. 114
F-69685 Chassieu cedex / France
Tel. +33 (0)4 7222 1722
Fax +33 (0)4 7222 1935

Note

We reserve the right to make technical changes or modify the contents of this document without prior notice. With regard to purchase orders, the agreed particulars shall prevail. ABB does not accept any responsibility whatsoever for potential errors or possible lack of information in this document.

We reserve all rights in this document and in the subject matter and illustrations contained therein. Any reproduction, disclosure to third parties or utilization of its contents – in whole or in parts – is forbidden without prior written consent of ABB.

Copyright© 2011 ABB
All rights reserved

1SNK162041D0201 - PDF

X-ON Electronics

Largest Supplier of Electrical and Electronic Components

Click to view similar products for [entrelec](#) manufacturer:

Other Similar products are found below :

[023103024](#) [023000107](#) [1SNK505310R0000](#) [017322627](#) [011762822](#) [016511417](#) [016340320](#) [1SNK516020R0000](#) [023300421](#)

[1SNK510010R0000](#) [018731214](#) [011870703](#) [010500220](#) [011511607](#) [023300227](#) [016049626](#) [017666704](#) [1SNK508411R0000](#) [023300320](#)

[016548827](#) [023300001](#) [012511813](#) [017301610](#) [011546820](#) [010500127](#)