

Specification 规格:

Material 物料规格: Housing Material: High-Temp Plastic LCP (UL 94V-0), White 高温塑胶
 Actuator: LCP (UL 94V-0), Black
 Contact: Phosphor Bronze 磷青铜
 Finish (a) Contact Plating: see ordering grid
 (b) Underplating: Nickel-plated all over
 Fitting Nail: Brass, tin plated 黄铜, 镀锡

Mechanical

Durability: 20 Cycles

Electrical 电气规格:

Voltage Rating (Max.): 50V AC/DC 最大额定电压 50V AC/DC
 Current Rating (Max.): 0.4A AC/DC 最大额定电流 0.4A AC/DC
 Dielectric Strength: 500V AC for 1 minute
 between adjacent terminal, no breakdown
 Insulation Resistance: 50 MΩ Min. 250V DC
 for 1 minute between adjacent terminal
 绝缘阻抗: 50MΩ, 250V DC 于相邻端子, 1分钟
 Contact Resistance: 40 mΩ Max. 连接阻抗: 40 毫欧
 Operating Temperature: -25°C to +85°C 工作温度: -25° to +85°
 Solder Profile: Peak Temp 260°C (+0/-5°C) Maximum (5 seconds)

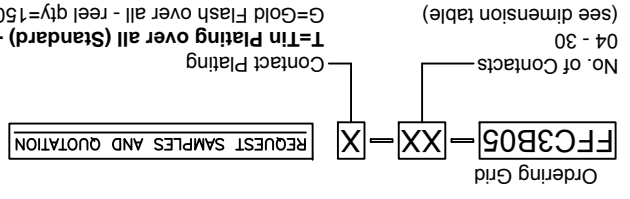

Pin No.	Dim.A	Dim.B	Dim.C	Dim.D
* 4	9.10	3.00	11.00	5.10
* 5	10.10	4.00	12.00	6.10
* 6	11.10	5.00	13.00	7.10
* 7	12.10	6.00	14.00	8.10
* 8	13.10	7.00	15.00	9.10
* 9	14.10	8.00	16.00	10.10
* 10	15.10	9.00	17.00	11.10
* 11	16.10	10.00	18.00	12.10
* 12	17.10	11.00	19.00	13.10
* 13	18.10	12.00	20.00	14.10
* 14	19.10	13.00	21.00	15.10
* 15	20.10	14.00	22.00	16.10
* 16	21.10	15.00	23.00	17.10
* 17	22.10	16.00	24.00	18.10
* 18	23.10	17.00	25.00	19.10
* 19	24.10	18.00	26.00	20.10
* 20	25.10	19.00	27.00	21.10
* 21	26.10	20.00	28.00	22.10
* 22	27.10	21.00	29.00	23.10
* 23	28.10	22.00	30.00	24.10
* 24	29.10	23.00	31.00	25.10
* 25	30.10	24.00	32.00	26.10
* 26	31.10	25.00	33.00	27.10
* 27	32.10	26.00	34.00	28.10
* 28	33.10	27.00	35.00	29.10
* 29	34.10	28.00	36.00	30.10
* 30	35.10	29.00	37.00	31.10

* = Tooled Parts

Please contact GCT for non-tooled parts

Non-tooled MOQ 10k pcs



www.globalconnectortech.com

Part Number:-	FCC3B05	Date:-	24 MAY 10
Description:-	FPC 1.0mm PITCH SIDE ENTRY, BOTTOM CONTACT, SMT, HEIGHT=2.5mm, ZIF, SLIDE TYPE		
Tolerances	(except as noted)		
Dimensions in mm	X.X ± 0.30 X.XX ± 1° X.XXX ± 0.15 X.XXX ± 0.10		
Third Angle Projection			

THIS DRAWING IS CONFIDENTIAL AND MUST NOT BE COPIED OR DISCLOSED WITHOUT WRITTEN CONSENT



Scale	NTS	Revision	A	See Note	Material	PKN	Drawn by	E & OE	Sheet No.
8	7	6	5	4	3	2	1	1/2	

By	PKN
DETAIL	DRAWING
REV	A
DATE	24/05/10

PIN NO.	DIM.A	DIM.B	DIM.C	DIM.D
4P	11	11.5		
5P	12	12.5		
6P	13	13.5		
7P	14	14.5		
8P	15	15.5		
9P	16	16.5		
10P	17	17.5		
11P	18	18.5		
12P	19	19.5		
13P	20	20.5		
14P	21	21.5		
15P	22	22.5		
16P	23	23.5		
17P	24	24.5		
18P	25	25.5		
19P	26	26.5		
20P	27	27.5		
21P	28	28.5		
22P	29	29.5		
23P	30	30.5		
24P	31	31.5		
25P	32	32.5		
26P	33	33.5		
27P	34	34.5		
28P	35	35.5		
29P	36	36.5		
30P	37	37.5		
			56	56.5
			44	44.5
			32	32.5
			24	24.5

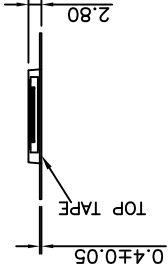
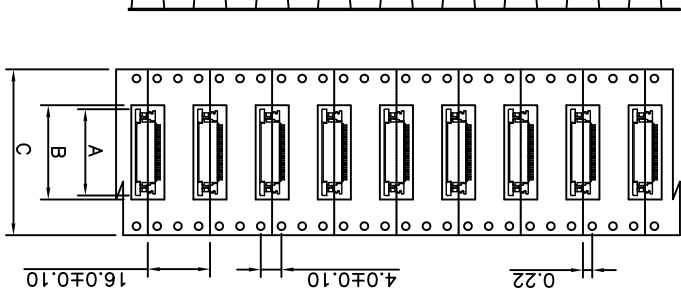
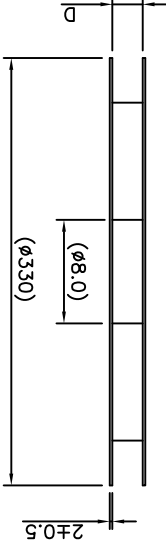
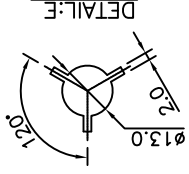
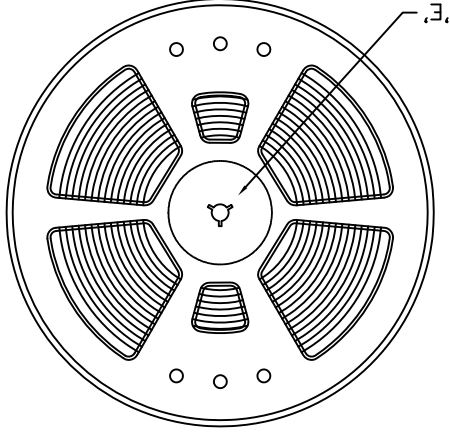

4. Peeling off force of top tape
 0.1N~0.7N(10.2gf~71.4gf)
 (Peeling direction as shown in
 following fig)

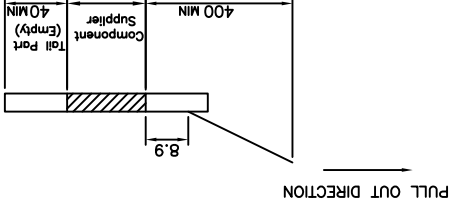

NOTES:
 1. Number of Connectors:
 1500 Pcs/Reel
 2. Material
 Carrier Tape: PET, PE, PEF
 Reel: PS
 3. Lead Tape Length:
 PULL OUT DIRECTION

Tolerances (Except as noted)	Part Number:- FFC3B05	Date:- 24 MAY 10
Dimensions in mm	Description:- FPC 1.0mm PITCH SIDE ENTRY, BOTTOM CONTACT, SMT, HEIGHT=2.5mm, ZIF, SLIDE TYPE	
X.X ± 0.30	X.X ± 2°	
X.XX ± 0.20	X.XX ± 1°	
X.XXX ± 0.10	X.XXX ± 0.5°	
Third Angle Projection	THIS DRAWING IS CONFIDENTIAL AND MUST NOT BE COPIED OR DISCLOSED WITHOUT WRITTEN CONSENT	
Scale	Revision	Material
NTS	A	See Note
7	Revision	Material
6	PKN	Drawn by
5	E & OE	Sheet No.
4	22	22

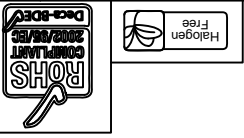

REV	A
DATE	24/05/10
DETAIL	RELEASE
By	PKN

GCT

www.globalconnectortechnology.com

X-ON Electronics

Largest Supplier of Electrical and Electronic Components

Click to view similar products for [FFC & FPC Connectors](#) category:

Click to view products by [GCT](#) manufacturer:

Other Similar products are found below :

[HFW11R-1STE1H1LF](#) [FH29B-100S-0.2SHW\(99\)](#) [FA5S008HP1](#) [FH29B-120S-0.2SHW\(99\)](#) [FH29B-80S-0.2SHW\(99\)](#) [FHS-16](#) [FPH-2022G](#)
[52610-1075](#) [52610-1275](#) [52610-1934](#) [XF3M\(1\)-1415-1B-R100](#) [501864-3091-TR225](#) [0525594033](#) [086210010340800](#) [086222026001800](#)
[52271-2869-CUT-TAPE](#) [62674-201121DLF](#) [62684-36210E9ALF](#) [52610-1675](#) [52746-1671-TR250](#) [10051922-2810EHLF](#) [6-520415-9](#)
[BD021-09A-A1-0350-0200-0550-LD](#) [SFV6R-1STE9HLF](#) [XF3M-2915-1B-R100](#) [1658549-1](#) [62674-221121ALF](#) [46214008010800](#)
[046298003000883](#) [151660622](#) [842-816-2630-035](#) [AYF530665TA](#) [AYF351525](#) [046296011930846+](#) [AYF352325A](#) [046254020000800+](#)
[FH19C-13S-0.5SH\(99\)](#) [FH39J-51S-0.3SHW\(99\)](#) [AYF355125A](#) [AYF530365TA](#) [FH29B-44S-0.2SHW\(99\)](#) [SFW5R-2STAE9LF](#) [AYF351125A](#)
[AYF350725A](#) [62684-502100AHLF](#) [FH39-61S-0.3SHW\(99\)](#) [AYF414035A](#) [10064555-172520HLF](#) [AYF212335A](#) [504754-2500](#)