

3 Handling WINSTA® MIDI, 770 Series

58

Preparation



We recommend pulling the pre-latched strain relief housing over the cable prior to termination. However, the strain relief can be mounted at a later time as well.

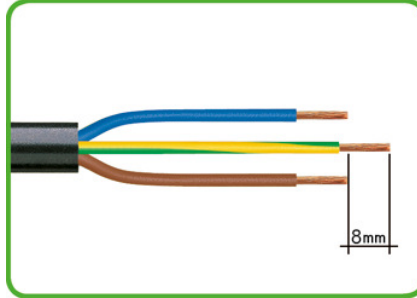

1. Strip length, outer insulation = x mm ①
2. Strip length = 9 mm
3. Extended ground conductor = 8 mm

Conductor termination with CAGE CLAMP® S

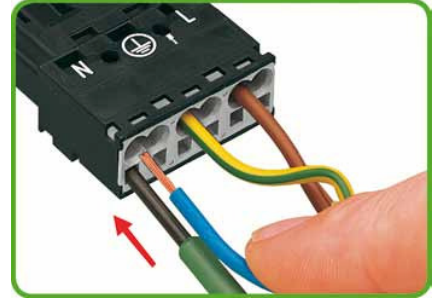

To terminate fine-stranded conductors, open clamping unit via 2.5mm screwdriver and insert stripped conductor until it hits backstop.

Conductor termination with CAGE CLAMP® S

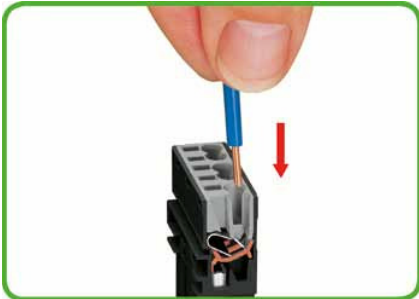

Insert stripped solid conductor until it hits backstop.

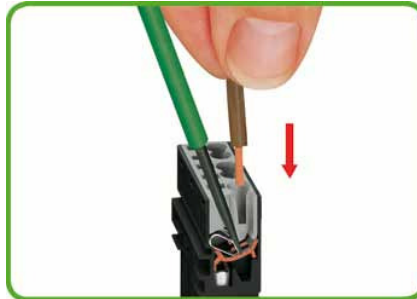

To terminate fine-stranded conductors, open clamping unit via 2.5mm screwdriver and insert stripped conductor until it hits backstop.

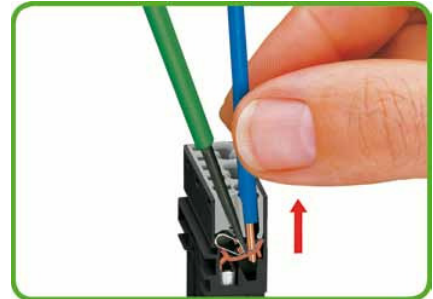

To remove the conductor, actuate the clamp via 2.5mm screwdriver and pull out the conductor.

Strain relief installation



Latch the strain relief housing on the plug/socket. Note the "TOP" inscription.



Prepare strain relief housing by snapping together upper and bottom part.



Tighten strain relief screw using a 2.5 mm screwdriver.

Variable coding



Simply break or cut off the coding pin from the socket.



Insert coding pin into plug (break first) until it engages.

Marking



Marking strain relief housing via WSB quick marking system.

① Strip length, outer insulation: 2-pole = 35mm, 3- to 5-pole = 55mm

3 WINSTA® MIDI





124

Linect® T-Connectors, T-Distribution Connectors, 5-Pole

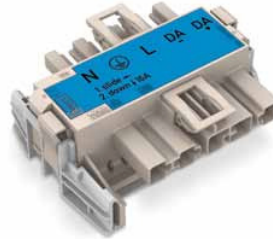

	400 V/6 kV/3 I_N 25 A (16 A) ① ② Approvals	400 V/6 kV/3 I_N 25 A ② Approvals
--	--	---



Description	Color	Item No.	Pack. Unit	Color	Item No.	Pack. Unit
Linect® T-connectors		Linect® T-connector ③, 5-pole,		T-distribution connector, 1 x plug / 2 x socket		
T-distribution connectors		socket - plug		● black	770-621	50
Intermediate couplers		White housing, white cover		○ white	770-671	50
	○ white	770-6225	25	● blue	770-617	50
		White housing, blue cover ④		● red	770-921	50
	● blue	770-7105	20	for "flying leads," with 3rd locking lever		
		White housing, dark gray cover		● black	770-622	50
	● dark gray	770-7505	20	○ white	770-672	50
				● blue	770-620	50
				● red	770-922	50
Item-Specific Accessories						
		Lockout cap, for socket, separable, 12-pole		Lockout cap, for socket, separable, 12-pole		
						
		black 770-201 100		black 770-201 100		
		white 770-221 100		white 770-221 100		
		Lockout cap, for plug, separable, 5-pole		Lockout cap, for plug, separable, 5-pole		
						
		yellow 770-360 100		yellow 770-360 100		
Info	Dimensions					

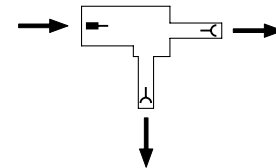
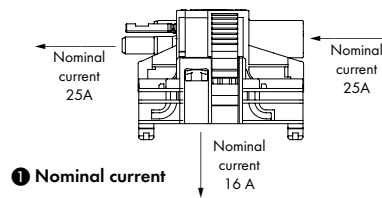

- ② For "International Certification Organizations" and "Approvals - User Guide," see pages 240 to 243.
- ③ For suitable lighting connectors, see page 61
- ④ Connectors for DALI applications
- ⑤ One locking lever for each intermediate coupler is included.

- black Coding A (N 3 L1 L2 L3)
- white Coding A (N 3 L1 L2 L3)
- blue Coding I (N ⊕ L DA- DA+)
- dark gray Coding L (N 3 L N' L')
- red Coding P (N 3 L1 L2 L3)

For coding information, see pages 224 to 226.
Fire load data available upon request.

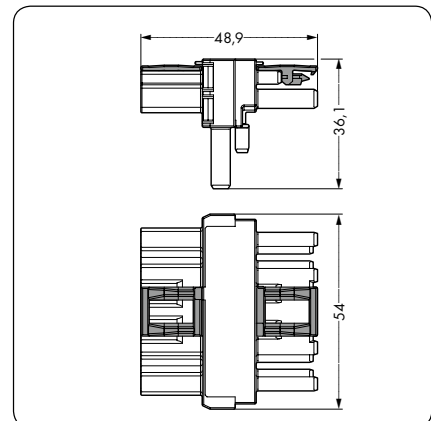
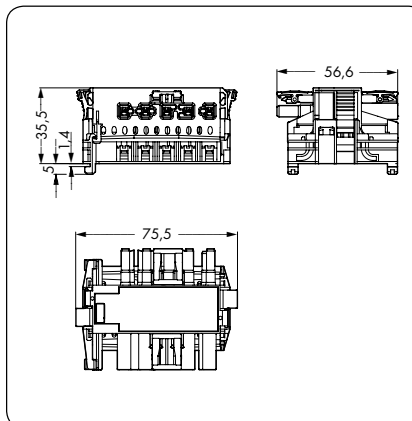

X-ON Electronics

Largest Supplier of Electrical and Electronic Components

Click to view similar products for [wago manufacturer](#):

Other Similar products are found below :

[750-460](#) [231-118/026-000](#) [231-303/026-000](#) [231-620/019-000](#) [257-403](#) [280-438](#) [280-831](#) [284-624](#) [210-111](#) [231-303/037-000](#) [231-446/001-000_NR](#) [232-216/026-000](#) [234-510](#) [264-726](#) [280-339](#) [0283-0671](#) [830-800/000-305](#) [750-512](#) [750-455](#) [51251782](#) [286-312](#) [713-1428/107-000](#) [731-138/048-000](#) [750-459](#) [750-517](#) [750-602](#) [793-3505](#) [826-172](#) [859-304](#) [280-335](#) [231-535/001-000](#) [2604-1105](#) [2604-1106](#) [2604-1504](#) [2606-1103/020-000](#) [2624-1103](#) [2626-3103/020-000](#) [821-104](#) [713-1107](#) [852-1411](#) [2106-1307](#) [2116-5307](#) [832-1205](#) [832-3604](#) [2009-110](#) [281-512/281-501](#) [286-336](#) [750-421](#) [750-838](#) [753-559](#)