

AlGaInP Visible Laser Diode

ADL-65075TL

DATE : 2005/10/18 Ver 1.0

★650nm 7mW 70 °C Reliable Operation!

★Ideal for DVD optical pick-up head

•Features

1. Low operating current
2. Higher power
3. High efficiency

•Applications

1. DVD player/ROM optical pick up
2. Combo drive optical pick up
3. Bar code scanner

•Absolute maximum ratings

Parameter	Symbol	Condition	Rating	Unit
Light output power	P_O	CW	10	mW
Reverse voltage (LD)	V_{RL}	-	2	V
Reverse voltage (PD)	V_{RD}	-	30	V
Forward current (PD)	I_{FD}	-	10	mA
Case temperature	T_C	-	-10~+70	°C
Storage temperature	T_S	-	-40~+85	°C

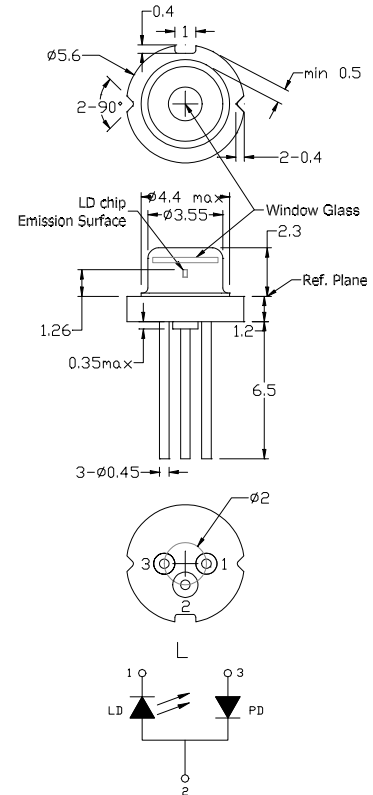

•Electrical and optical characteristics ($T_c=25^\circ\text{C}$)

Parameter	Symbol	Min.	Typ.	Max.	Unit	Conditions
Peak wavelength	λ	645	650	660	nm	$P_o=7\text{mW}$
Threshold current	I_{th}	-	20	25	mA	
Operating current	I_{op}	-	27	35	mA	$P_o=7\text{mW}$
Operating voltage	V_{op}	-	2.2	2.5	V	$P_o=7\text{mW}$
Differential efficiency	η	0.7	1.0	1.2	mW/mA	$P_o=3\text{--}5\text{mW}$
Monitor current	I_m	0.1	0.15	0.3	mA	$P_o=7\text{mW}, V_{RD}=5\text{V}$
Parallel divergence angle	$\theta_{ }$	6	9	12	deg	
Perpendicular divergence angle	θ_{\perp}	25	28	32	deg	
Parallel FFP deviation angle	$\Delta\theta_{ }$	-3	0	+3	deg	$P_o=7\text{mW}$
Perpendicular FFP deviation angle	$\Delta\theta_{\perp}$	-3	0	+3	deg	
Emission point accuracy	$\Delta x \Delta y \Delta z$	-80	0	+80	um	

• Precautions

- * Do not operate the device above maximum ratings. Doing so may cause unexpected and permanent damage to the device.
- * Take precautions to avoid electrostatic discharge and/or momentary power spikes. A change in the characteristics of the laser or premature failure may result.
- * Proper heat sinking of the device assures stability and lifetime. Always ensure that maximum operating temperatures are not exceeded.
- * Observing visible or invisible laser beams with the human eye directly, or indirectly, can cause permanent damage. Use a camera to observe the laser.
- * No laser device should be used in any application or situation where life or property is at risk in event of device failure.
- * Specifications are subject to change without notice. Ensure that you have the latest specification by contacting us prior to purchase or use of the product

* For reference only. Contents above are subject to change without notice.

AlGaInP Visible Laser Diode

ADL-65075TL

DATE : 2005/10/18 Ver 1.0

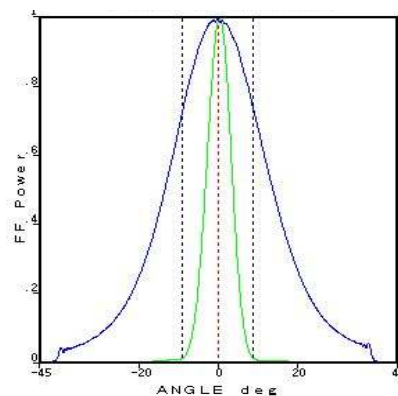
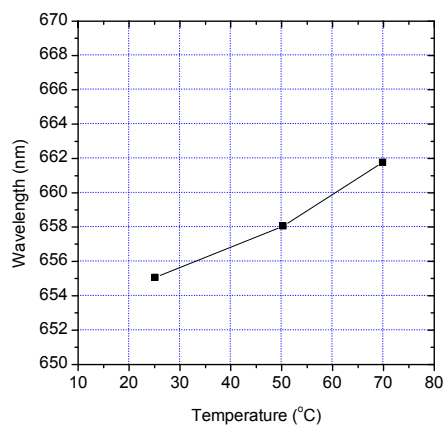
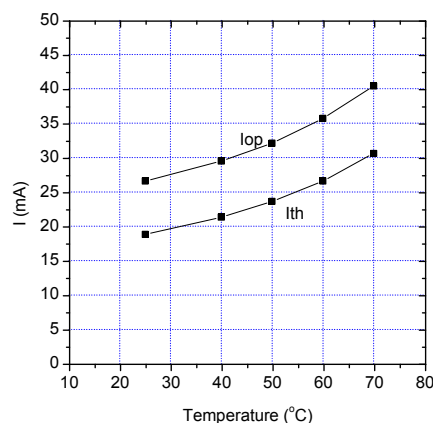
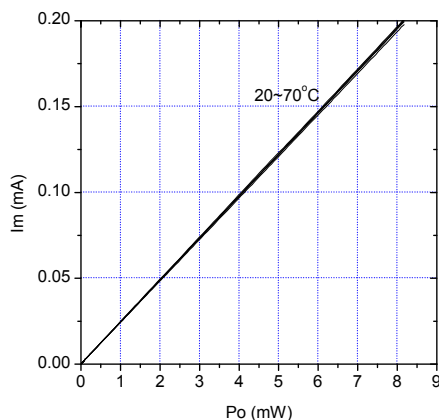
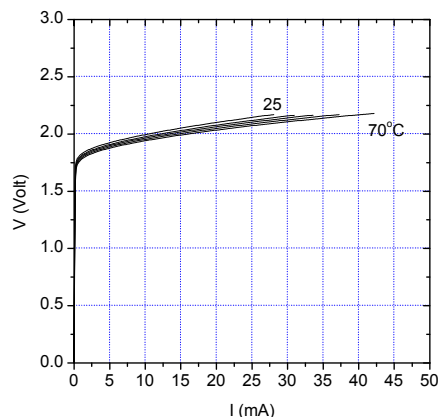
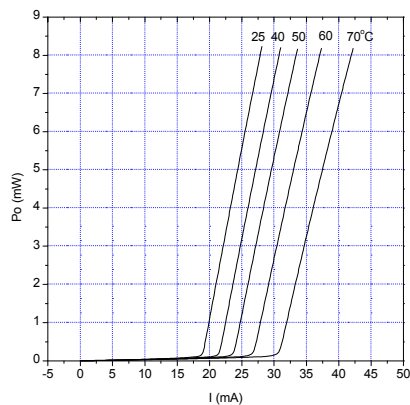

* For reference only. Contents above are subject to change without notice.

X-ON Electronics

Largest Supplier of Electrical and Electronic Components

Click to view similar products for [laser components manufacturer](#):

Other Similar products are found below :

[FP-HD-L-635-7-30-F](#) [IG22X1000S4I](#) [FP-D-520-1-C-F](#) [FP-D-650-1D-C-F](#) [FP-LR-635-1-C-F](#) [FP-MV18-ST-660-20-30-F-STD](#) [FP-D-405-16-E-F](#) [FP-D-635-17-C-F](#) [FP-D-635-3-E-F](#) [FP-D-635-7-E-F](#) [FP-D-650-25-E-F](#) [FP-D-650-3-E-F](#) [FP-D-660-40-C-F](#) [FP-D-670-1-C-F](#) [FP-D-670-5-C-F](#) [FP-D-785-50-C-F](#) [FP-D-850-1-C-F](#) [FP-D-850-5-E-F](#) [FP-L-635-5-50-C](#) [FP-L-850-3-50-C](#) [FP-L-905-5-50-C](#) [FP-MG-19](#) [FP-MS-11.5](#) [FP-D-650-1-C-F](#) [IG17X1300S4I](#) [LC-LMD-635-03-03-A](#) [LC-LMD-650-05-01-A](#) [FP-MINI-635-1-F](#) [FP-MINI-650-1-F](#) [IG22X250S4I](#) [ILM12F-DOE-520-7-259-F](#) [FP-D-635-13-E-F](#) [FP-D-635-40-C-F](#) [FP-D-905-7-E-F](#) [FP-L-405-15-50-C](#) [FP-L-635-1-50-C](#) [FP-L-650-1-50-C](#) [LC-LMP-635-287-03-A](#) [FP-D-520-5-C-F](#) [IG17X250S4I](#) [ILM12F-DOE-635-7-247-F](#) [FP-D-635-1-C-F](#) [FP-D-635-1-C-F-24V](#) [ILM12F-D-520-1-C-F](#) [FP-D-650-20-C-F-24](#) [ADL-65104TA4](#) [ILM12F-L-520-7-58-F](#) [ADL-65104TL](#) [LC-LMD-635-02-03-A](#) [FP-HD-DOE-520-7-289-F](#)