

0.5mm pitch, 2.5mm above the board, high speed transmission connector for shielded FFC

FH41 Series

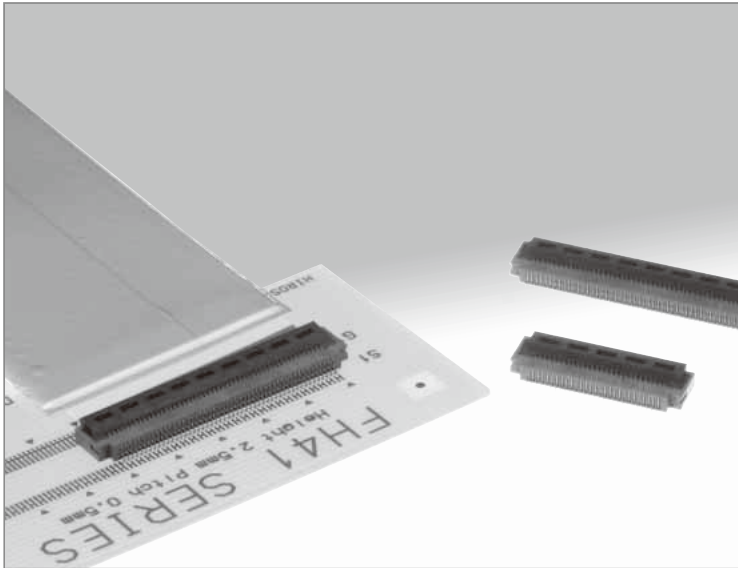

■ Features

1. Compatibility with impedance control, shield FFC

The FH41 series is equipped with a GND exclusive terminal and available for connection with impedance control, shield FFC.

2. Differential impedance $100\Omega \pm 10\%$

The FH41 series features a terminal design considering impedance control, and making high speed transmission possible.

3. Highly reliable connection, tough structure

The FH41 series follows the structure of the proven FH28 series, and achieves:

- High reliability thanks to the FFC positioning mechanism
- Reliable connection operation and no unlocking thanks to the durable structure.

4. One-finger operation of the actuator

Proven (in several other Hirose's connectors!) Flip-Lock rotating actuator assures reliable mechanical and electrical connection with FFC, confirming it with a definite tactile feel.

5. Board placement with automatic equipment

Flat upper surface and tape and reel packaging facilitate vacuum pick-up and placement. Standard reel packaging contains 2,500 connectors.

6. Halogen-free *

*As defined by IEC61249-2-21
Br-900ppm maximum, Cl-900ppm maximum,
Cl + Br combined-1,500ppm maximum

THine Electronics, Inc.
Next-generation chipset (V-by-One®HS*)
Compatible connector

* High-speed serial interface technology for image transmission



Space saving (68 pos. shown)

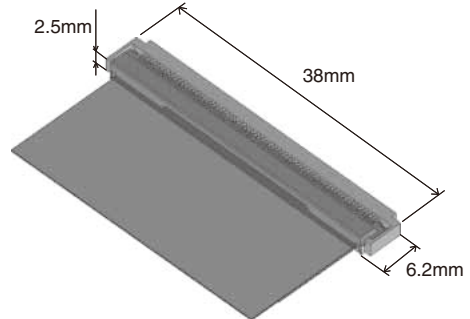

figure.1

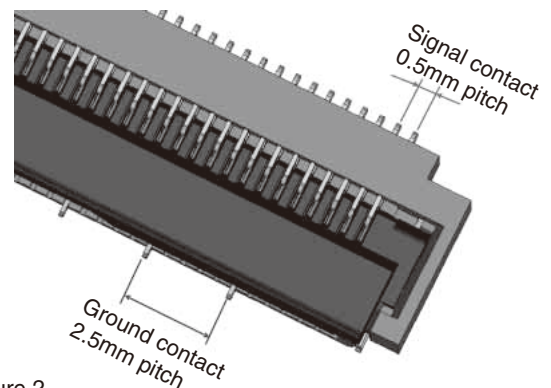

figure.2

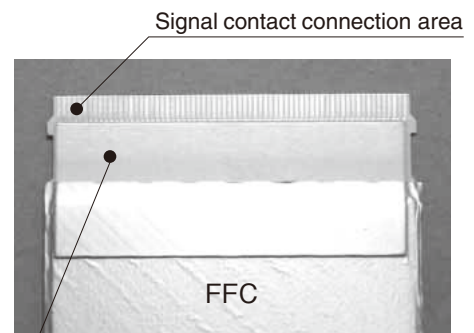

figure.3

■Specifications

Ratings	Current rating 0.5 A(Note1) Voltage rating 50 Vrms AC	Operating temperature range: -40 to +85°C (Note 2) Operating humidity range: Relative humidity 90% max. (No condensation)	Storage temperature range: -10 to +50°C (Note 3) Storage humidity range: Relative humidity 90% max. (No condensation)
---------	--	--	--

Recommended FPC Thickness	0.3 ±0.05 mm, Gold plated contact pads (GND plate:t=0.5±0.05mm,tinϕplating)
---------------------------	---

Item	Specification	Conditions
1.Insulation resistance	500 MΩ min.	100 V DC
2.Withstanding voltage	No flashover or insulation breakdown	150 Vrms AC / one minute
3.Contact resistance	100 mΩ max. * Including FFC conductor resistance	1 mA, AC max (AC: 1kHz)
4.Durability	Contact resistance: 100 mΩ max. No damage, cracks, or parts dislocation	20 cycles
5.Vibration	No electrical discontinuity of 1μs or longer Contact resistance: 100 mΩ max. No damage, cracks, or parts dislocation	Frequency: 10 to 55 Hz, single amplitude of 0.75mm, 10 cycles in each of the 3 directions
6.Shock	No electrical discontinuity of 1μs or longer Contact resistance: 100 mΩ max. No damage, cracks, or parts dislocation	Acceleration of 981m/s ² 6 ms duration, sine halfwave, 3 cycles in each of the 3 axis
7.Humidity (Steady state)	Contact resistance: 100 mΩ max. Insulation resistance: 50 MΩ min. No damage, cracks, or parts dislocation	96 hours at 40°C and humidity of 90 to 95%
8.Temperature cycle	Contact resistance: 100 mΩ max. Insulation resistance: 50 MΩ min. No damage, cracks, or parts dislocation	Temperature : -40°C → +15°C to +35°C → +85°C → +15°C to +35°C Time: 30 → 2 to 3 → 30 → 2 to 3 minutes 5 cycles
9.Resistance to soldering heat	No deformation of components affecting performance	Reflow: At the recommended temperature profile Manual soldering: 350°C ±5°C for 5 seconds

Note 1. When passing the current through all of the contacts, use 70% of the rated current.

Note 2. Includes temperature rise caused by current flow.

Note 3. The term "storage" refers to products stored for a long period prior to mounting and use.

The operating temperature and humidity range covers the non-conducting condition of installed connectors in storage, shipment or during transportation after board mounting.

Note 4. Information contained in this catalog represents general requirements for this Series.

Contact us for the drawings and specifications for a specific part number shown.

■Materials

Part	Material	Finish	Remarks
Insulator	LCP	Color:Gray	UL94V-0
		Color:Black	
Contacts	Phosphor bronze	Gold plated	—
		Pure tin reflow plated	
Metal fittings	Brass		

■Ordering information

FH 41 - 50S - 0.5 SH (05)

① ② ③ ④ ⑤ ⑥

① Series name : FH	⑤ SH : SMT horizontal mounting type
② Series No.: 41	⑥ Plating specifications :(05)...Gold plated
③ Number of positions : 28 to 68	
④ Contact pitch : 0.5mm	

■ Connector Dimensions

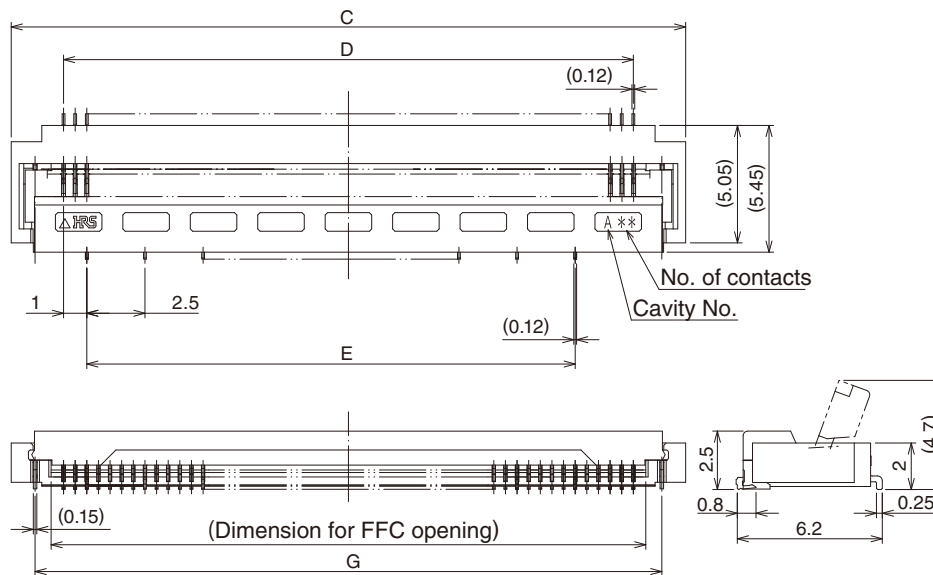

- Note 1. The coplanarity of each terminal lead within specified dimension is 0.1 mm Max.
 2. Packaged on tape and reel only. Check packaging specification.
 3. Slight variations in color of the plastic compounds do not affect form, fit or function of the connector.
 4. After reflow, the terminal plating may change color, however this does not represent a quality issue.

Unit : mm

Part Number	CL No.	Number of contacts	No. of Contacts(GND contacts)	C	D	E	F	G
FH41-28S-0.5SH(05)	580-2208-1-05	28	5	18	13.5	10	14.57	15.95
FH41-40S-0.5SH(05)	580-2205-3-05	40	8	24	19.5	17.5	20.57	21.95
FH41-50S-0.5SH(05)	580-2204-0-05	50	10	29	24.5	22.5	25.57	26.95
FH41-68S-0.5SH(05)	580-2202-5-05	68	13	38	33.5	30	34.57	35.95

Note1. Tape and reel packaging (2,500 pieces/reel).
 Order by number of reels.

Recommended PCB mounting pattern and metal mask dimensions

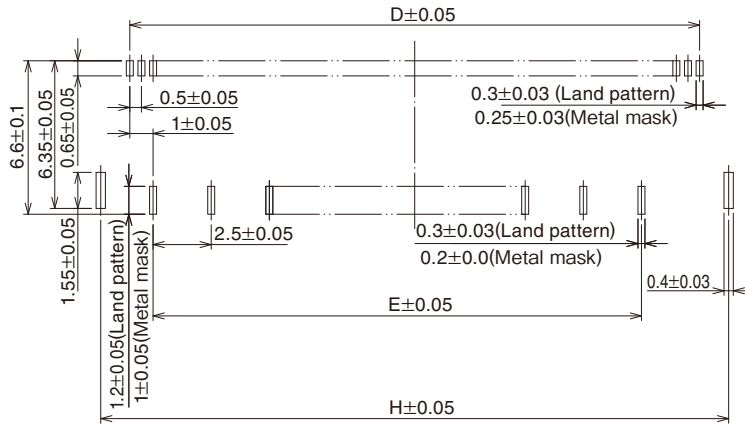

Recommended metal mask thickness $t=0.1$

Recommended FFC Dimensions

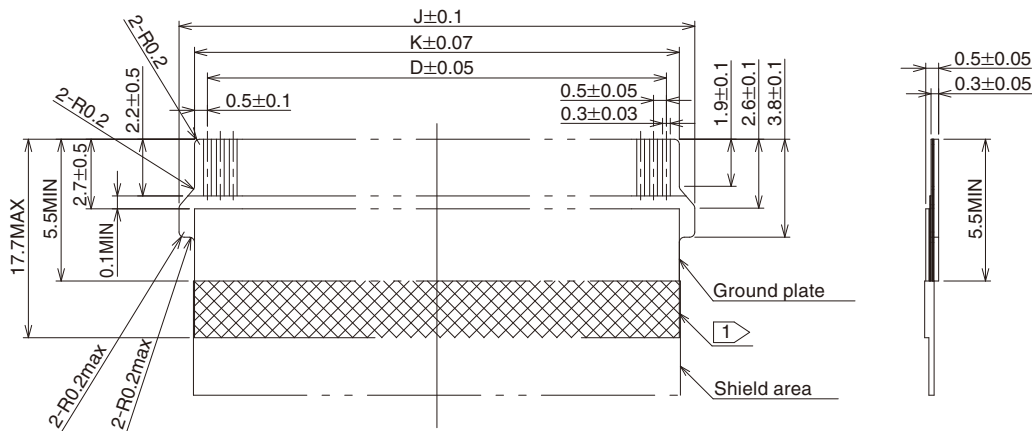

Note 1 Please overlap shield plate on ground plate.

Unit : mm

Part Number	CL No.	Number of contacts	No. of Contacts(GND contacts)	H	J	K
FH41-28S-0.5SH(05)	580-2208-1-05	28	5	16	15.7	14.5
FH41-40S-0.5SH(05)	580-2205-3-05	40	8	22	21.7	20.5
FH41-50S-0.5SH(05)	580-2204-0-05	50	10	27	26.7	25.5
FH41-68S-0.5SH(05)	580-2202-5-05	68	13	36	35.7	34.5

Note1. Tape and reel packaging (2,500 pieces/reel).
Order by number of reels.

■ Recommended FFC construction

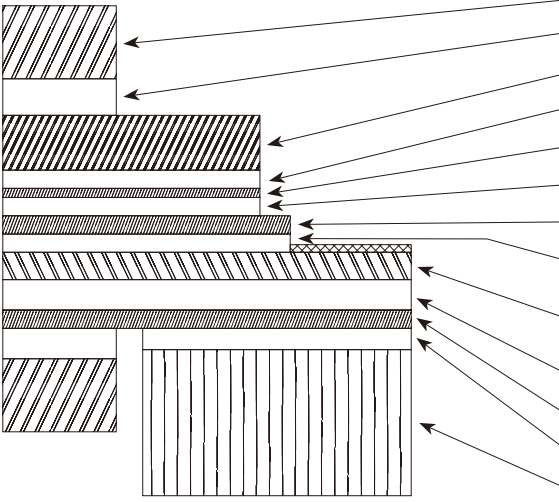

Material Name	Material	thickness(μm)	thickness(μm)
Shielding Material			
Conouctiye Adhesive	Polyester Type		
Copper Film (Tin Plated)		70	<1
Adhesive	Acrylic Type	24	<1
Base Material	Polyester Type	12	<1
Adhesive	Acrylic Type	24	<1
Insulated Layer	Polyester Type	25	
Adhesive	Polyester Type	35	
Soft Copper Film (Nickel Under Plated / Gold Plated)		35	35
Adhesive	Polyester Type	35	35
Insulated Layer	Polyester Type	25	25
Adhesive	Polyester Type	30	30
Siiffener	Polyester Type	188	188
Total		503	313

Note 1 ▷ Please overlap shield plate on ground plate.

■ Packaging Specification

● Embossed Carrier Tape Dimensions

(Tape width of 24mm max.)

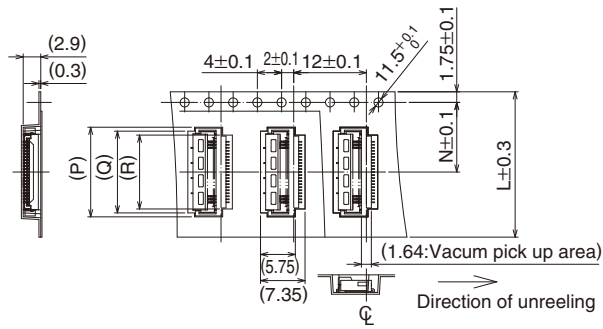

(Tape width of 32mm min.)

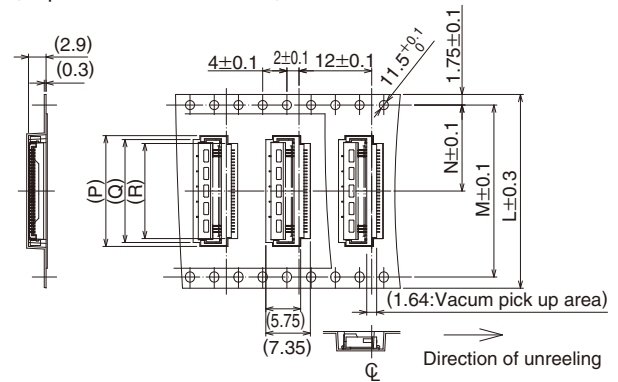

● Reel Dimensions

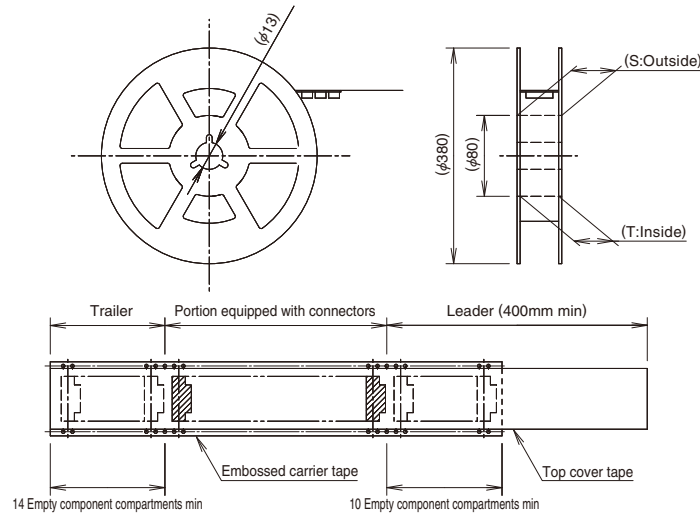

Unit : mm

Part Number	CL No.	Number of contacts	No. of Contacts(GND contacts)	L	M	N	P	Q	R	S	T
FH41-28S-0.5SH(05)	580-2208-1-05	28	5	32	28.4	14.2	18.3	17	15.7	37.4	33.4
FH41-40S-0.5SH(05)	580-2205-3-05	40	8	44	40.4	20.2	24.3	23	21.7	49.4	45.4
FH41-50S-0.5SH(05)	580-2204-0-05	50	10	44	40.4	20.2	29.3	28	26.7	49.4	45.4
FH41-68S-0.5SH(05)	580-2202-5-05	68	13	56	52.4	26.2	38.3	37	35.7	61.4	57.4

Temperature Profile

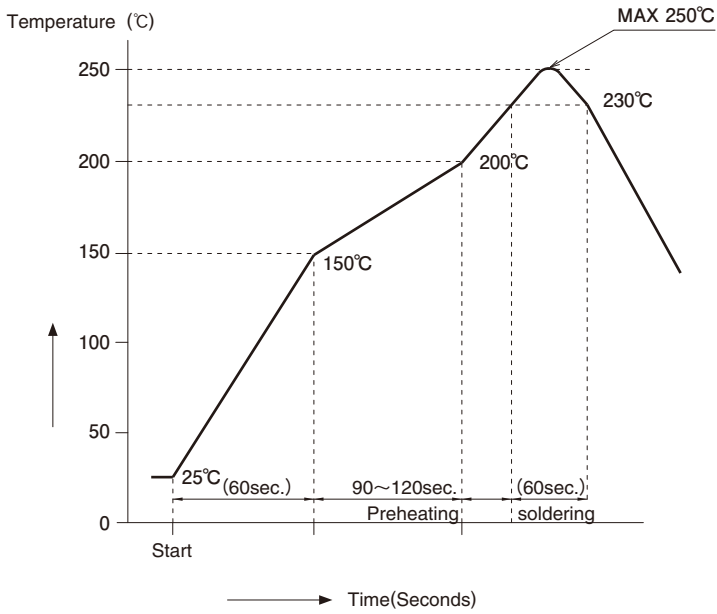

HRS test condition



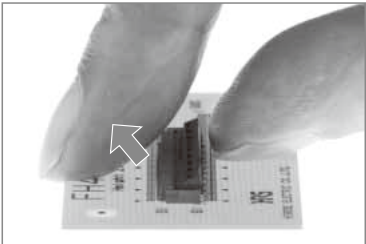
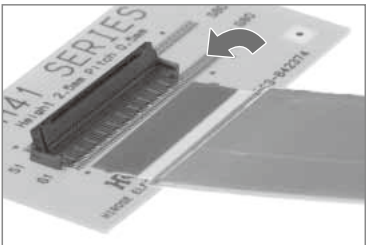
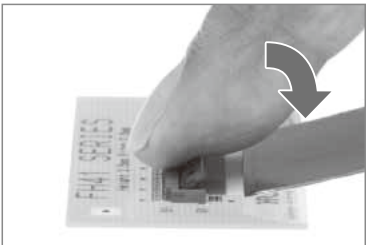
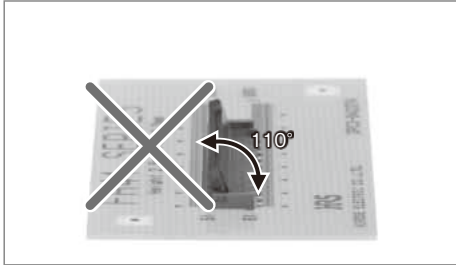
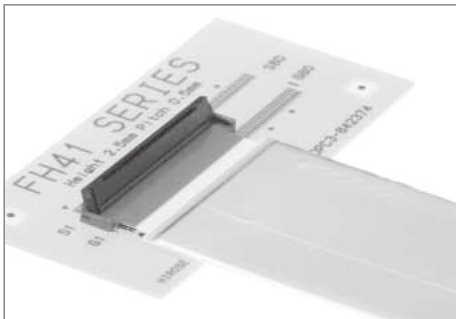
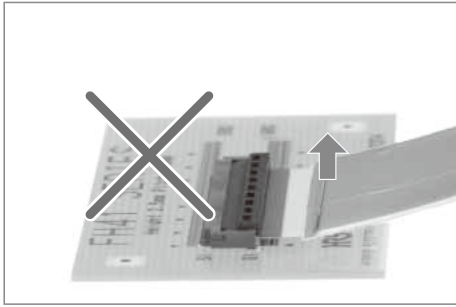
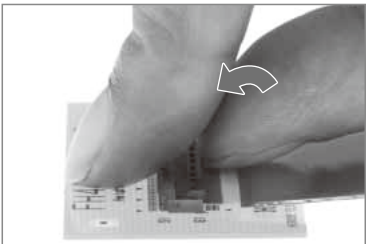

Solder method	:Reflow, IR/hot air
Environment	:Room air
Solder composition	:Paste, 96.5%Sn/3.0%Ag/0.5%Cu (Senju Metal Industry, Co., Ltd.'s Part Number:M705-221CM5-32-10.5)
Test board	:Glass epoxy 30mm×60mm×0.8mm thick
Land dimensions	:0.3mm×0.65mm, 0.3mm×1.2mm
Metal mask	:0.25×0.65, 0.2×0.1mm thick

The temperature profiles shown are based on the above conditions. In individual applications the actual temperature may vary, depending on solder paste type, volume / thickness and board size / thickness. Consult your solder paste and equipment manufacturer for specific recommendations.

■ Operation and Precautions

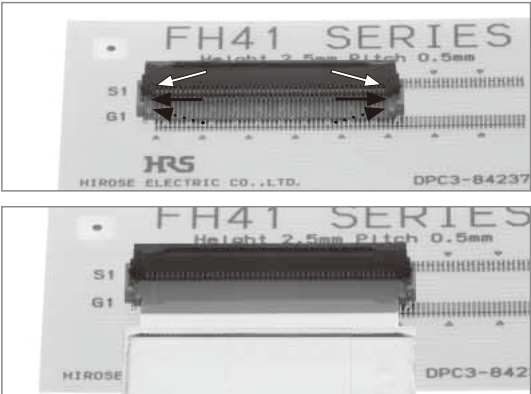
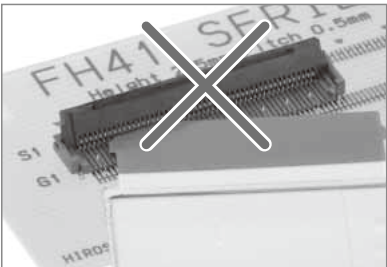
Operation	Precautions
<p>1.FFC insertion procedure. Connector installed on the board.</p> <p>① Lift up the actuator. Use thumb or index finger</p>  <p>② Fully insert the FFC in the connector parallel to mounting surface, with the exposed conductive traces facing down.</p>  <p>③ Rotate down the actuator until firmly closed. It is critical that the inserted FFC is not moved and remains fully inserted.</p> 	<p>① Do not force the actuator to open beyond its fully open position. Do not use any type of tool to open the actuator.</p>  <p>② Do not forcefully bend the FFC upward. Consult FFC manufacturer for the recommended bend radiuses.</p>  <p>③ For connectors with multiple contacts, such as 80 pos. rotate down the actuator pushing at both ends.</p> 
<p>2.FFC removal</p> <p>Fully open the actuator. Carefully withdraw the FFC exercising caution not to deform or damage it.</p> 	<p>④ Load to FFC</p> <p>Be very careful not to apply any force to the connector directly after inserting FFC. Otherwise, the connector may become unlocked or the FFC may break.</p> <p>In particular, design the FFC layout with care not to bend it sharply upward in a vertical direction near the insertion opening.</p> <p>Fix the FFC when loads are applied to it continuously.</p>

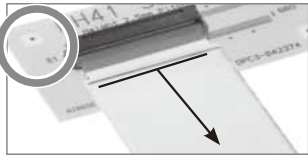
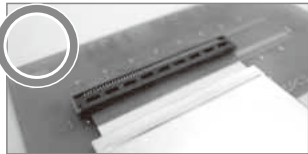
■Precautions (mating/un-mating FFC with the retention tabs)

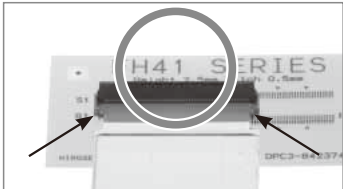
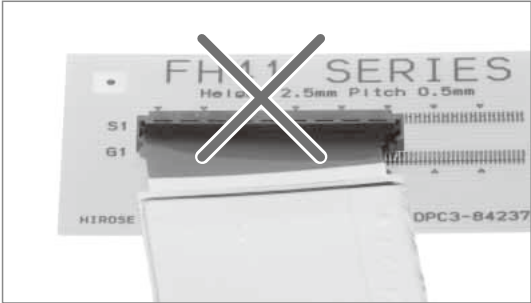
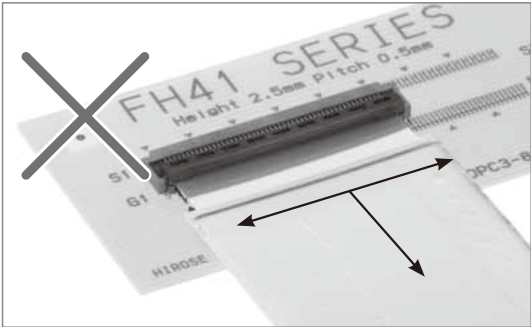
Operation	Precautions
<p>1.How to insert</p> <p>Insert the cable into the interspace between the mold walls (→) at both ends of entrance where the connector is inserted and the guide walls (⇨) at both ends of interior connector so the cable tabs are properly located.</p>  <p>2.Precautions when mating /un-mating</p> <p>① Avoid insertion in diagonal direction. Do not insert the cable in diagonal direction. A part of the connector may touches the contacts resulting in deformation of the contacts.</p>  <p>Insert the cable straight into the connector and hook the cable tabs with the guide.</p> <p>After insertion, slightly pull the cables to make sure the cable tabs are firmly secured. No removal of the cable means correct insertion.</p>  <p>① Insert the cable straight and obliquely from above.</p>  <p>② Slightly pull the cable to make sure the tabs are firmly secured.</p>  <p>③ Close the actuator.</p>	<p>② Avoid “ride on”</p> <p>Avoid insertion so the cables ride on any guide. Be sure NOT to close the actuator as the cables ride on any guide. It may cause conduction failure.</p> <p>Ride on a left guide</p>  <p>Ride on a right guide</p>  <p>Correct insertion</p>  <p>Do not close the actuator as the cables ride on.</p>  <p>In the event it is locked as the cables ride on a guide, absolutely avoid moving the cable. In this case, open the actuator and re-insert the cable as instructed in “1.How to insert”</p> <p>Do not move the cables back and forth and around as the cables ride on the guide when the actuator is closed.</p> 

NOTES :

Dotted lines for notes.

USA:

HIROSE ELECTRIC (U.S.A.), INC. Headquarters
2688 Westhills Court, Simi Valley, CA 93065-6235
Phone : 1-805-522-7958
Fax : 1-805-522-3217
<http://www.hiroseusa.com>

USA:

HIROSE ELECTRIC (U.S.A.), INC. North California Office
20400 Stevens Creek Blvd., Ste 250, Cupertino,
CA 95014
Phone : 1-408-253-9640
Fax : 1-408-253-9641
<http://www.hiroseusa.com>

USA:

HIROSE ELECTRIC (U.S.A.), INC. Detroit Office (Automotive)
37677 Professional Center Drive, Suite #100C
Livonia, MI 48154
Phone : 1-734-542-9963
Fax : 1-734-542-9964
<http://www.hiroseusa.com>

GERMANY:

HIROSE ELECTRIC EUROPE B.V. GERMAN BRANCH
Herzog-Carl-Strasse 4 D-73760 Ostfildern
(Scharnhäuser Park)
Phone : 49-711-4560-02-1
Fax : 49-711-4560-02-299
<http://www.hirose.de>

THE NETHERLANDS:

HIROSE ELECTRIC EUROPE B.V.
Hogehillweg #8 1101 CC Amsterdam Z-0
Phone : 31-20-6557460
Fax : 31-20-6557469
<http://www.hiroseeurope.com>

UK:

HIROSE ELECTRIC EUROPE B.V. UK BRANCH
First Floor, St Andrews House, Caldecotte Lake
Business Park, Milton Keynes MK7 8LE
Phone : 44-1908-369060
Fax : 44-1908-369078
<http://www.hirose.co.uk>

CHINA:

HIROSE ELECTRIC CO., LTD. BEIJING REPRESENTATIVE OFFICE
A1001, Ocean International Center, Building 56# East 4th
Ring Middle Road, Chao Yang District, Beijing, 100025
Phone : 86-10-5165-9332
Fax : 86-10-5908-1381
<http://www.hirose-china.com.cn>

CHINA:

HIROSE ELECTRIC (SHANGHAI) CO., LTD.
1501-02, Cross Tower Building, 318 Fuzhou Road,
Huang Pu District, Shanghai 200001
Phone : 86-21-6391-3355
Fax : 86-21-6335-0767
<http://www.hirose-china.com.cn>

CHINA:

HIROSE ELECTRIC CO., LTD. SHENZHEN OFFICE
Room 09-13, 19/F, Office Tower Shun Hing Square, Di Wang Commercial Centre
5002, ShenNanDong Road, ShenZhen City, Guangdong Province, 518008
Phone : 86-755-8207-0851
Fax : 86-755-8207-0873
<http://www.hirose-china.com.cn>

HONG KONG:

HIROSE ELECTRIC HONGKONG TRADING CO., LTD.
Unit 1102 A&B, Energy Plaza, 92 Granville Road,
Tsim Sha Tsui East, Kowloon
Phone : 852-2803-5338
Fax : 852-2591-6560
<http://www.hirose-hongkong.com.hk>

TAIWAN:

HIROSE ELECTRIC TAIWAN CO., LTD.
103 8F, No.87, Zhengzhou Rd., Taipei
Phone : 886-2-2555-7377
Fax : 886-2-2555-7350
<http://www.hirose-taiwan.com.tw>

SINGAPORE:

HIROSE ELECTRIC CO., LTD.
10 Anson Road #26-16 International Plaza 079903
Phone : 65-6324-6113
Fax : 65-6324-6123
<http://www.hirose-singapore.com.sg>

KOREA:

HIROSE KOREA CO., LTD.
1261-10, Jeoungwhang-Dong, Shihung-City,
Kyunggi-Do 429-450
Phone : 82-31-496-7000,7124
Fax : 82-31-496-7100
<http://www.hirose.co.kr>



HRS

HIROSE ELECTRIC CO.,LTD.

5-23,OSAKI 5-CHOME,SHINAGAWA-KU,TOKYO 141-8587,JAPAN
PHONE: 81-3-3491-5300, FAX: 81-3-3495-5230
<http://www.hirose.com>
<http://www.hirose-connectors.com>

X-ON Electronics

Largest Supplier of Electrical and Electronic Components

Click to view similar products for [FFC & FPC Connectors](#) category:

Click to view products by [Hirose](#) manufacturer:

Other Similar products are found below :

[HFW11R-1STE1H1LF](#) [FH29B-100S-0.2SHW\(99\)](#) [FA5S008HP1](#) [FH29B-120S-0.2SHW\(99\)](#) [FH29B-80S-0.2SHW\(99\)](#) [FHS-16](#) [FPH-2022G](#)
[52610-1075](#) [52610-1275](#) [52610-1934](#) [XF3M\(1\)-1415-1B-R100](#) [501864-3091-TR225](#) [0525594033](#) [086210010340800](#) [086222026001800](#)
[52271-2869-CUT-TAPE](#) [62674-201121DLF](#) [62684-36210E9ALF](#) [52610-1675](#) [52746-1671-TR250](#) [10051922-2810EHLF](#) [6-520415-9](#)
[BD021-09A-A1-0350-0200-0550-LD](#) [SFV6R-1STE9HLF](#) [XF3M-2915-1B-R100](#) [1658549-1](#) [62674-221121ALF](#) [46214008010800](#)
[046298003000883](#) [151660622](#) [842-816-2630-035](#) [AYF530665TA](#) [AYF351525](#) [046296011930846+](#) [AYF352325A](#) [046254020000800+](#)
[FH19C-13S-0.5SH\(99\)](#) [FH39J-51S-0.3SHW\(99\)](#) [AYF355125A](#) [AYF530365TA](#) [FH29B-44S-0.2SHW\(99\)](#) [SFW5R-2STAE9LF](#) [AYF351125A](#)
[AYF350725A](#) [62684-502100AHLF](#) [FH39-61S-0.3SHW\(99\)](#) [AYF414035A](#) [10064555-172520HLF](#) [AYF212335A](#) [504754-2500](#)