

# AF09 ... AF38 3-pole Contactors up to 18.5 kW / 20 hp

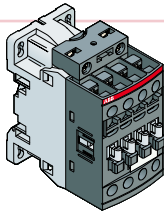

<b>Overview</b> .....	2
<b>Ordering Details</b>	
– AF09 ... AF38 3-pole Contactors .....	4
– AF.Z Additional Coils .....	5
<b>Technical Data</b> .....	6
<b>Main Accessory Fitting Details</b> .....	11
<b>Accessory Ordering Details and Technical Data</b> .....	12
<b>Terminal Marking and Positioning</b> .....	18
<b>Dimensions</b> .....	20



**AF09 ... AF16**  
3-pole contactors

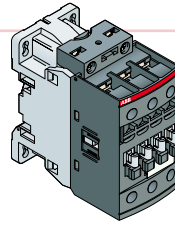

**AF26 ... AF38**  
3-pole contactors

## for Contactors

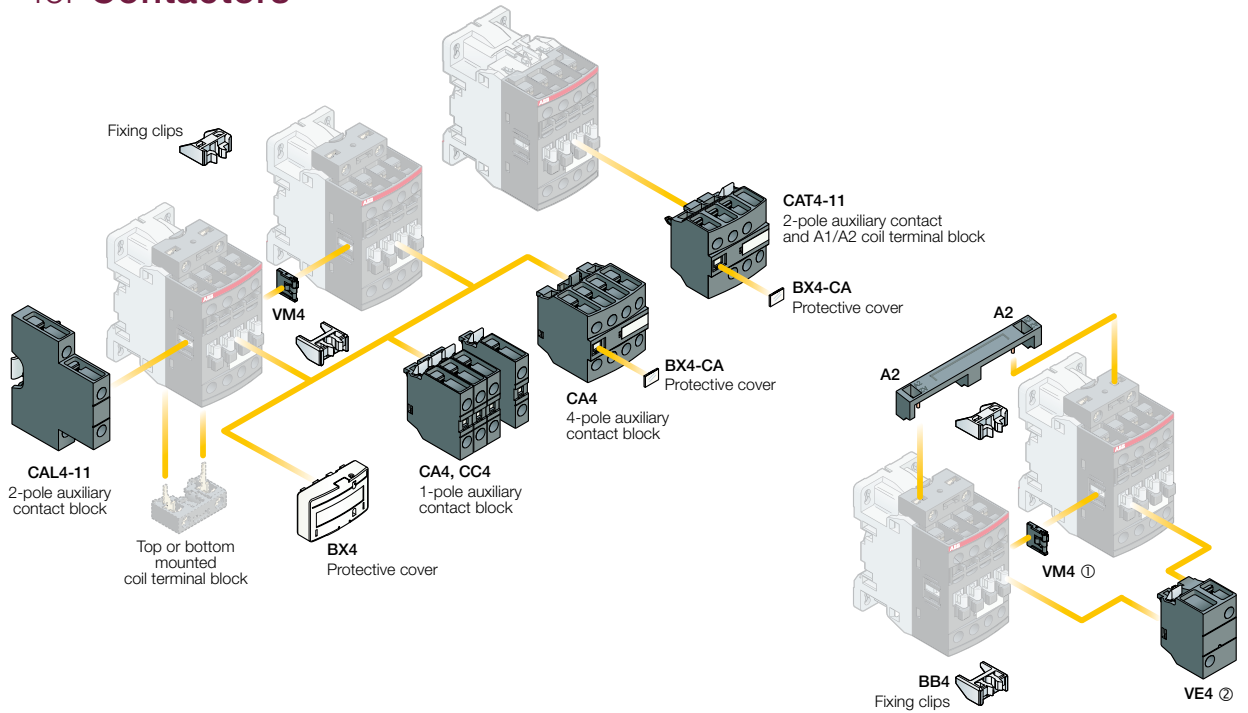

**VEM4 mechanical and electrical interlock set including:**  
 ① VM4 mechanical interlock unit including 2 fixing clips (BB4)  
 ② VE4 electrical interlock block with A2-A2 connection

## for Starting Solutions

### Direct-On-Line Starter

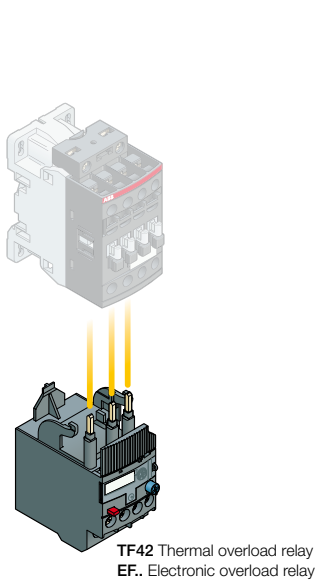

### Reversing Starter

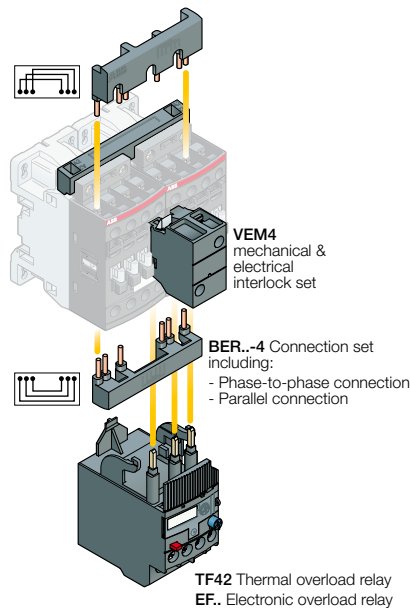

### Star-Delta Starter

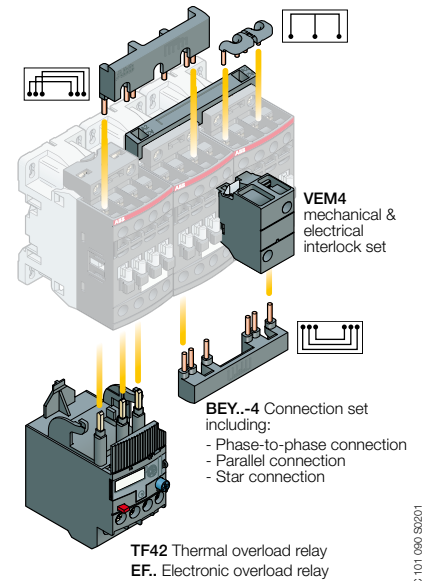

# 3-pole Contactors



AC / DC control voltage

AF09	AF12	AF16
AF09-30-10	AF12-30-10	AF16-30-10
AF09-30-01	AF12-30-01	AF16-30-01

AF26	AF30	AF38
AF26-30-00	AF30-30-00	AF38-30-00

## Switching of 3-phase Cage Motors

	IEC	AC-3	Rated power	400 V
	UL/CSA	Motor rating Nema size	Rated operational current	$\theta \leq 60^\circ\text{C}$ 400 V $\theta \leq 60^\circ\text{C}$ 415 V $\theta \leq 60^\circ\text{C}$ 690 V
Motor rating			480 V	

4 kW	5.5 kW	7.5 kW
9 A	12 A	18 A
9 A	12 A	18 A
7 A	9 A	10.5 A
5 hp	7.5 hp	10 hp
00	0	-

11 kW	15 kW	18.5 kW
26 A	32 A	38 A
26 A	32 A	38 A
17 A	21 A	24 A
15 hp	20 hp	20 hp
1	-	-

### Protection of 3-phase motors

Thermal overload relays

Electronic overload relays

TF42...

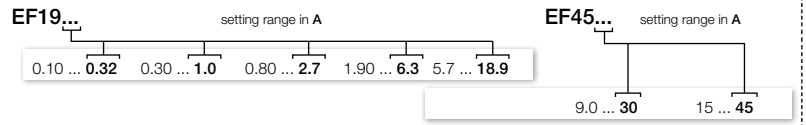

## Switching of Resistive Circuits

	IEC	AC-1	Rated operational current	$\theta \leq 40^\circ\text{C}$ 690 V $\theta \leq 60^\circ\text{C}$ 690 V $\theta \leq 70^\circ\text{C}$ 690 V
	UL/CSA	General use rating With conductor cross-sectional area	General use rating	600 V AC

25 A	28 A	30 A
25 A	28 A	30 A
22 A	24 A	26 A
4 mm <sup>2</sup>	6 mm <sup>2</sup>	6 mm <sup>2</sup>
25 A	28 A	30 A
AWG 10	AWG 10	AWG 10

45 A	50 A	50 A
40 A	42 A	42 A
32 A	37 A	37 A
10 mm <sup>2</sup>	10 mm <sup>2</sup>	10 mm <sup>2</sup>
45 A	50 A	50 A
AWG 8	AWG 8	AWG 8

## Main Accessories

Auxiliary contact blocks	Front mounting	
	Side mounting	
Interlocks	Mechanical / electrical	
	Mechanical	
Connection sets	Reversing Starters	
	Star-Delta Starters	

1-pole CA4-10 or CA4-01, CC4-10 or CC4-01	
4-pole CA4	
2-pole CAT4-11 (with coil front connection)	
2-pole CAL4-11	
<b>VEM4</b> including VM4 mechanical interlock unit and VE4 electrical interlock block with A2-A2 connection	
<b>VM4</b> including 2 fixing clips	
<b>BER16-4</b>	<b>BER38-4</b>
<b>BEY16-4</b>	<b>BEY38-4</b>

1SBC101090S201

# AF09 ... AF38 3-pole Contactors

## AC / DC Operated - with Screw Terminals



AF09-30-10



AF26-30-00

### Application

**AF09 ... AF38** contactors are used for controlling power circuits up to 690 V AC and 220 V DC. They are mainly used for controlling 3-phase motors, non-inductive or slightly inductive loads.

### Description

- **AF09 ... AF38** contactors include an electronic coil interface accepting a wide control voltage  $U_c$  min. ...  $U_c$  max. Only four coils cover control voltages between 24...500 V 50/60 Hz or 20...500 V DC
- **AF** contactors can manage large control voltage variations. One coil (e.g. 100...250 V 50/60 Hz - DC) can be used for different control voltages used worldwide without any coil change
- **AF.Z** contactors equipped with a **Z** coil type allow direct control by 24 V DC 500 mA PLC-output and obtain a reduced holding coil consumption.
- **AF.Z** contactors withstand short dips and voltage interruptions (SEMI F47-0706 compliance)
- **AF** contactors have built-in surge protection and do not require additional surge suppressors
- The built-in N.C. auxiliary contact is a mirror contact in compliance with annex F of IEC 60947-4-1.

### Ordering Details

IEC Rated power 400 V AC-3 kW	UL/CSA 3-phase motor rating 480 V hp	Control voltage $U_c$ min. ... $U_c$ max.		Auxiliary contacts fitted 	Type	Order code	Weight  Pack <sup>(ing)</sup> 1 piece kg		
		V 50/60 Hz	V DC						
4	5	24...60	20...60	1 0	AF09Z-30-10-21	1SBL 136 001 R2110	0.310		
		24...60	20...60	0 1	AF09Z-30-01-21	1SBL 136 001 R2101	0.310		
		48...130	48...130	1 0	AF09-30-10-12	1SBL 137 001 R1210	0.270		
		48...130	48...130	0 1	AF09-30-01-12	1SBL 137 001 R1201	0.270		
		100...250	100...250	1 0	AF09-30-10-13	1SBL 137 001 R1310	0.270		
		100...250	100...250	0 1	AF09-30-01-13	1SBL 137 001 R1301	0.270		
		250...500	250...500	1 0	AF09-30-10-14	1SBL 137 001 R1410	0.310		
		250...500	250...500	0 1	AF09-30-01-14	1SBL 137 001 R1401	0.310		
		5.5	7.5	24...60	20...60	1 0	AF12Z-30-10-21	1SBL 156 001 R2110	0.310
				24...60	20...60	0 1	AF12Z-30-01-21	1SBL 156 001 R2101	0.310
				48...130	48...130	1 0	AF12-30-10-12	1SBL 157 001 R1210	0.270
				48...130	48...130	0 1	AF12-30-01-12	1SBL 157 001 R1201	0.270
100...250	100...250			1 0	AF12-30-10-13	1SBL 157 001 R1310	0.270		
100...250	100...250			0 1	AF12-30-01-13	1SBL 157 001 R1301	0.270		
250...500	250...500			1 0	AF12-30-10-14	1SBL 157 001 R1410	0.310		
250...500	250...500			0 1	AF12-30-01-14	1SBL 157 001 R1401	0.310		
7.5	10			24...60	20...60	1 0	AF16Z-30-10-21	1SBL 176 001 R2110	0.310
				24...60	20...60	0 1	AF16Z-30-01-21	1SBL 176 001 R2101	0.310
				48...130	48...130	1 0	AF16-30-10-12	1SBL 177 001 R1210	0.270
				48...130	48...130	0 1	AF16-30-01-12	1SBL 177 001 R1201	0.270
		100...250	100...250	1 0	AF16-30-10-13	1SBL 177 001 R1310	0.270		
		100...250	100...250	0 1	AF16-30-01-13	1SBL 177 001 R1301	0.270		
		250...500	250...500	1 0	AF16-30-10-14	1SBL 177 001 R1410	0.310		
		250...500	250...500	0 1	AF16-30-01-14	1SBL 177 001 R1401	0.310		
		11	15	24...60	20...60	0 0	AF26Z-30-00-21	1SBL 236 001 R2100	0.350
				48...130	48...130	0 0	AF26-30-00-12	1SBL 237 001 R1200	0.310
				100...250	100...250	0 0	AF26-30-00-13	1SBL 237 001 R1300	0.310
				250...500	250...500	0 0	AF26-30-00-14	1SBL 237 001 R1400	0.350
15	20	24...60	20...60	0 0	AF30Z-30-00-21	1SBL 276 001 R2100	0.350		
		48...130	48...130	0 0	AF30-30-00-12	1SBL 277 001 R1200	0.310		
		100...250	100...250	0 0	AF30-30-00-13	1SBL 277 001 R1300	0.310		
		250...500	250...500	0 0	AF30-30-00-14	1SBL 277 001 R1400	0.350		
18.5	20	24...60	20...60	0 0	AF38Z-30-00-21	1SBL 296 001 R2100	0.350		
		48...130	48...130	0 0	AF38-30-00-12	1SBL 297 001 R1200	0.310		
		100...250	100...250	0 0	AF38-30-00-13	1SBL 297 001 R1300	0.310		
		250...500	250...500	0 0	AF38-30-00-14	1SBL 297 001 R1400	0.350		

# AF09 ... AF38 3-pole Contactors - AF..Z Additional Coils

Catalogue Page 1SBC 101 072 S0201

## AC / DC Operated - with Screw Terminals



### Application

**AF09Z ... AF38Z** contactors are used for controlling power circuits up to 690 V AC and 220 V DC. They are mainly used for controlling 3-phase motors, non-inductive or slightly inductive loads.

### Description

- **AF09Z ... AF38Z** contactors include an electronic coil interface accepting a wide control voltage  $U_c$  min. ...  $U_c$  max and managing large control voltage variations.
- **AF..Z** contactors cover control voltages comprised between 24...250 V 50/60 Hz or 12...250 V DC
- **AF..Z** contactors allow direct control by PLC-output  $\geq 24$  V DC 500 mA and obtain a reduced holding coil consumption.
- **AF..Z** contactors withstand short dips and voltage interruptions (SEMI F47-0706 compliance)
- **AF..Z** contactors have built-in surge protection and do not require additional surge suppressors
- The built-in N.C. auxiliary contact is a mirror contact in compliance with annex F of IEC 60947-4-1.

### Ordering Details

IEC Rated power 400 V AC-3 kW	UL/CSA 3-phase motor rating hp	Control voltage $U_c$ min. ... $U_c$ max.		Auxiliary contacts fitted      	Type	Order code	Weight  Pack(ing) 1 piece kg		
		V 50/60 Hz	V DC						
4	5	-	12...20	1 0	AF09Z-30-10-20	1SBL 136 001 R2010	0.310		
		-	12...20	0 1	AF09Z-30-01-20	1SBL 136 001 R2001	0.310		
		24...60	20...60	1 0	AF09Z-30-10-21	1SBL 136 001 R2110	0.310		
		24...60	20...60	0 1	AF09Z-30-01-21	1SBL 136 001 R2101	0.310		
		48...130	48...130	1 0	AF09Z-30-10-22	1SBL 136 001 R2210	0.310		
		48...130	48...130	0 1	AF09Z-30-01-22	1SBL 136 001 R2201	0.310		
		100...250	100...250	1 0	AF09Z-30-10-23	1SBL 136 001 R2310	0.310		
		100...250	100...250	0 1	AF09Z-30-01-23	1SBL 136 001 R2301	0.310		
		5.5	7.5	-	12...20	1 0	AF12Z-30-10-20	1SBL 156 001 R2010	0.310
				-	12...20	0 1	AF12Z-30-01-20	1SBL 156 001 R2001	0.310
24...60	20...60			1 0	AF12Z-30-10-21	1SBL 156 001 R2110	0.310		
24...60	20...60			0 1	AF12Z-30-01-21	1SBL 156 001 R2101	0.310		
48...130	48...130			1 0	AF12Z-30-10-22	1SBL 156 001 R2210	0.310		
48...130	48...130			0 1	AF12Z-30-01-22	1SBL 156 001 R2201	0.310		
100...250	100...250			1 0	AF12Z-30-10-23	1SBL 156 001 R2310	0.310		
100...250	100...250			0 1	AF12Z-30-01-23	1SBL 156 001 R2301	0.310		
7.5	10			-	12...20	1 0	AF16Z-30-10-20	1SBL 176 001 R2010	0.310
				-	12...20	0 1	AF16Z-30-01-20	1SBL 176 001 R2001	0.310
		24...60	20...60	1 0	AF16Z-30-10-21	1SBL 176 001 R2110	0.310		
		24...60	20...60	0 1	AF16Z-30-01-21	1SBL 176 001 R2101	0.310		
		48...130	48...130	1 0	AF16Z-30-10-22	1SBL 176 001 R2210	0.310		
		48...130	48...130	0 1	AF16Z-30-01-22	1SBL 176 001 R2201	0.310		
		100...250	100...250	1 0	AF16Z-30-10-23	1SBL 176 001 R2310	0.310		
		100...250	100...250	0 1	AF16Z-30-01-23	1SBL 176 001 R2301	0.310		
		11	15	-	12...20	0 0	AF26Z-30-00-20	1SBL 236 001 R2000	0.350
				24...60	20...60	0 0	AF26Z-30-00-21	1SBL 236 001 R2100	0.350
48...130	48...130			0 0	AF26Z-30-00-22	1SBL 236 001 R2200	0.350		
100...250	100...250			0 0	AF26Z-30-00-23	1SBL 236 001 R2300	0.350		
15	20	-	12...20	0 0	AF30Z-30-00-20	1SBL 276 001 R2000	0.350		
		24...60	20...60	0 0	AF30Z-30-00-21	1SBL 276 001 R2100	0.350		
		48...130	48...130	0 0	AF30Z-30-00-22	1SBL 276 001 R2200	0.350		
		100...250	100...250	0 0	AF30Z-30-00-23	1SBL 276 001 R2300	0.350		
18.5	20	-	12...20	0 0	AF38Z-30-00-20	1SBL 296 001 R2000	0.350		
		24...60	20...60	0 0	AF38Z-30-00-21	1SBL 296 001 R2100	0.350		
		48...130	48...130	0 0	AF38Z-30-00-22	1SBL 296 001 R2200	0.350		
		100...250	100...250	0 0	AF38Z-30-00-23	1SBL 296 001 R2300	0.350		

Note: Only AF..Z contactors with DC control voltage 12...20 V DC need to respect the connection polarities indicated close to the coil terminals: A1+ for the positive pole and A2- for the negative pole

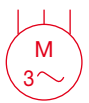

### Main Pole - Utilization Characteristics according to IEC

Contactor types	AF09	AF12	AF16	AF26	AF30	AF38	
<b>Standards</b>	IEC 60947-1 / 60947-4-1 and EN 60947-1 / 60947-4-1						
<b>Rated operational voltage <math>U_e</math> max.</b>	690 V						
<b>Rated frequency limits</b>	25 ... 400 Hz						
<b>Conventional free-air thermal current <math>I_{th}</math></b> acc. to IEC 60947-4-1, open contactors, $\theta \leq 40^\circ\text{C}$ with conductor cross-sectional area	35 A 6 mm <sup>2</sup>	35 A 6 mm <sup>2</sup>	35 A 6 mm <sup>2</sup>	50 A 10 mm <sup>2</sup>	50 A 10 mm <sup>2</sup>	50 A 10 mm <sup>2</sup>	
<b>AC-1 Utilization category</b> for air temperature close to contactor							
<b><math>I_e</math> / AC-1 rated operational current</b> $U_e$ max. $\leq 690\text{ V}$ , 50/60 Hz							
$\theta \leq 40^\circ\text{C}$	25 A	28 A	30 A	45 A	50 A	50 A	
$\theta \leq 60^\circ\text{C}$	25 A	28 A	30 A	40 A	42 A	42 A	
$\theta \leq 70^\circ\text{C}$	22 A	24 A	26 A	32 A	37 A	37 A	
with conductor cross-sectional area	4 mm <sup>2</sup>	6 mm <sup>2</sup>	6 mm <sup>2</sup>	10 mm <sup>2</sup>	10 mm <sup>2</sup>	10 mm <sup>2</sup>	
<b>AC-3 Utilization category</b> for air temperature close to contactor $\theta \leq 60^\circ\text{C}$ (for 1500 r.p.m., 50 Hz or 1800 r.p.m., 60 Hz, 3-phase motors)							
<b><math>I_e</math> / AC-3 max. rated operational current</b>							
 3-phase motors	220-230-240 V	9 A	12 A	18 A	26 A	33 A	40 A
	380-400 V	9 A	12 A	18 A	26 A	32 A	38 A
	415 V	9 A	12 A	18 A	26 A	32 A	38 A
	440 V	9 A	12 A	18 A	26 A	32 A	38 A
	500 V	9.5 A	12.5 A	15 A	23 A	28 A	33 A
	690 V	7 A	9 A	10.5 A	17 A	21 A	24 A
	<b>AC-3 rated operational power</b>						
 1500 r.p.m. 50 Hz 1800 r.p.m. 60 Hz 3-phase motors	220-230-240 V	2.2 kW	3 kW	4 kW	6.5 kW	9 kW	11 kW
	380-400 V	4 kW	5.5 kW	7.5 kW	11 kW	15 kW	18.5 kW
	415 V	4 kW	5.5 kW	9 kW	11 kW	15 kW	18.5 kW
	440 V	4 kW	5.5 kW	9 kW	15 kW	18.5 kW	22 kW
	500 V	5.5 kW	7.5 kW	9 kW	15 kW	18.5 kW	22 kW
	690 V	5.5 kW	7.5 kW	9 kW	15 kW	18.5 kW	22 kW
	<b>Rated making capacity AC-3</b>	10 x $I_e$ AC-3 acc. to IEC 60947-4-1					
<b>Rated breaking capacity AC-3</b>	8 x $I_e$ AC-3 acc. to IEC 60947-4-1						
<b>AC-8a Utilization category</b> (without thermal overload relay - $U_e$ 400 V - $\theta \leq 40^\circ\text{C}$ )							
<b><math>I_e</math> / AC-8a rated operational current</b>							
<b>AC-8a rated operational power</b>							
	12 A	16 A	22 A	30 A	40 A	50 A	
	5.5 kW	7.5 kW	11 kW	15 kW	20 kW	25 kW	
<b>Short-circuit protection for contactors</b> without thermal O/L relay - Motor protection excluded $U_e \leq 500\text{ V AC}$ - gG type fuse							
	25 A	32 A	32 A	50 A	63 A	63 A	
<b>Rated short-time withstand current <math>I_{cw}</math></b> at 40 °C ambient temperature, in free air from a cold state							
1 s	300 A	300 A	300 A	700 A	700 A	700 A	
10 s	150 A	150 A	150 A	350 A	350 A	350 A	
30 s	80 A	80 A	80 A	225 A	225 A	225 A	
1 min	60 A	60 A	60 A	150 A	150 A	150 A	
15 min	35 A	35 A	35 A	50 A	50 A	50 A	
<b>Maximum breaking capacity</b> $\cos \varphi = 0.45$							
at 440 V	250 A	250 A	250 A	500 A	500 A	500 A	
at 690 V	106 A	106 A	106 A	200 A	200 A	200 A	
<b>Heat dissipation per pole</b>							
$I_e$ / AC-1	0.8 W	1 W	1.2 W	1.8 W	2.4 W	2.4 W	
$I_e$ / AC-3	0.1 W	0.2 W	0.35 W	0.6 W	0.9 W	1.3 W	
<b>Max. electrical switching frequency</b>							
AC-1	600 cycles/h						
AC-3	1200 cycles/h						
AC-2, AC-4	300 cycles/h			150 cycles/h			

# AF09 ... AF38 3-pole Contactors

## Technical Data

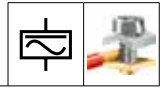

### Built-in Auxiliary Contacts according to IEC

Contactor types	AF09	AF12	AF16	AF26	AF30	AF38
Rated operational voltage $U_e$ max.	690 V					
Conventional free air thermal current $I_{th} - \theta \leq 40$ °C	16 A					
Rated frequency limits	25 ... 400 Hz					
Rated operational current $I_e$ / AC-15						
acc. to IEC 60947-5-1	24-127 V 50/60 Hz	6 A				
	220-240 V 50/60 Hz	4 A				
	400-440 V 50/60 Hz	3 A				
	500 V 50/60 Hz	2 A				
	690 V 50/60 Hz	2 A				
Making capacity AC-15	10 x $I_e$ AC-15 acc. to IEC 60947-5-1					
Breaking capacity AC-15	10 x $I_e$ AC-15 acc. to IEC 60947-5-1					
Rated operational current $I_e$ / DC-13						
acc. to IEC 60947-5-1	24 V DC	6 A / 144 W				
	48 V DC	2.8 A / 134 W				
	72 V DC	1 A / 72 W				
	110 V DC	0.55 A / 60 W				
	125 V DC	0.55 A / 69 W				
	220 V DC	0.27 A / 60 W				
	250 V DC	0.27 A / 68 W				
	400 V DC	0.15 A / 60 W				
	500 V DC	0.13 A / 65 W				
	600 V DC	0.1 A / 60 W				
Short-circuit protection gG type fuse	10 A					
Rated short-time withstand current $I_{cw}$	for 1.0 s	100 A				
	for 0.1 s	140 A				
Minimum switching capacity	12 V / 3 mA					
with failure rate acc. to IEC 60947-5-4	$10^{-7}$					
Non-overlapping time between N.O. and N.C. contacts	$\geq 2$ ms					
Heat dissipation per pole at 6 A	0.1 W					
Max. electrical switching frequency	AC-15	1200 cycles/h				
	DC-13	900 cycles/h				

# AF09 ... AF38 3-pole Contactors

Catalogue Page 1SBC 101 108 S0201

## Technical Data

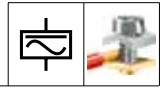

### Main Pole - Utilization Characteristics according to UL / NEMA / CSA

Contactor types		AF09	AF12	AF16	AF26	AF30	AF38
Standards		UL 508, CSA C22.2 N°14					
Rated operational voltage U <sub>e</sub> max.		600 V					
NEMA size		00	0	-	1	-	-
NEMA continuous amp rating	thermal current	9 A	18 A		27 A		
NEMA maximum H.P. ratings 1-phase, 60 Hz	115 V AC	1/3 hp	1 hp		2 hp		
	230 V AC	1 hp	2 hp		3 hp		
NEMA maximum H.P. ratings 3-phase, 60 Hz	200 V AC	1-1/2 hp	3 hp		7-1/2 hp		
	230 V AC	1-1/2 hp	3 hp		7-1/2 hp		
	460 V AC	2 hp	5 hp		10 hp		
	575 V AC	2 hp	5 hp		10 hp		
<b>UL General use rating</b>							
600 V AC		25 A	28 A	30 A	45 A	50 A	50 A
With conductor cross-sectional area		AWG 10	AWG 10	AWG 10	AWG 8	AWG 8	AWG 8
80 V DC - 1-pole		25 A	28 A	30 A	45 A	50 A	50 A
With conductor cross-sectional area		AWG 10	AWG 10	AWG 10	AWG 8	AWG 8	AWG 8
<b>UL maximum 1-phase motor rating</b>							
Amp-rating	120 V AC	13.8 A	16 A	20 A	24 A	24 A	24 A
	240 V AC	10 A	12 A	17 A	17 A	28 A	28 A
Motor power	120 V AC	3/4 hp	1 hp	1-1/2 hp	2 hp	2 hp	2 hp
	240 V AC	1-1/2 hp	2 hp	3 hp	3 hp	5 hp	5 hp
<b>UL maximum 3-phase motor rating</b>							
Amp-rating	200-208 V AC	7.8 A	11 A	17.5 A	25.3 A	32.2 A	32.2 A
	220-240 V AC	6.8 A	9.6 A	15.2 A	22 A	28 A	28 A
	440-480 V AC	7.6 A	11 A	14 A	21 A	27 A	27 A
	550-600 V AC	9 A	11 A	17 A	22 A	(1)	(1)
	Motor power	200-208 V AC	2 hp	3 hp	5 hp	7.5 hp	10 hp
(for 1500 r.p.m., 50 Hz or 1800 r.p.m., 60 Hz 3-phase motors)	220-240 V AC	2 hp	3 hp	5 hp	7.5 hp	10 hp	10 hp
440-480 V AC	5 hp	7.5 hp	10 hp	15 hp	20 hp	20 hp	
550-600 V AC	7.5 hp	10 hp	15 hp	20 hp	(1)	(1)	
<b>Short-circuit protection</b>							
for contactors without thermal O/L relay - Motor protection excluded							
Fuse rating		60 A	60 A	60 A	150 A	150 A	150 A
Fuse type, 600 V		NTD					
<b>Max. electrical switching frequency</b>							
for general use		600 cycles/h					
for motor use		1200 cycles/h					
<b>Mechanical durability</b>							
Number of operating cycles		10 millions operating cycles					
Max. switching frequency		3600 cycles/h					

(1) On request

### Built-in Auxiliary Contacts according to UL / CSA

Contactor types		AF09	AF12	AF16	AF26	AF30	AF38
Max. rated operational voltage U <sub>e</sub> max.		600 V AC, 600 V DC					
Pilot duty		A600, Q600					
AC thermal rated current		10 A					
AC maximum volt-ampere making		7200 VA					
AC maximum volt-ampere breaking		720 VA					
DC thermal rated current		2.5 A					
DC maximum volt-ampere making-breaking		69 VA					



# AF09 ... AF38 3-pole Contactors

## Technical Data



### General Technical Data

Contactors types	AF09	AF12	AF16	AF26	AF30	AF38
<b>Rated insulation voltage <math>U_i</math></b> acc. to IEC 60947-4-1	690 V					
acc. to UL / CSA	600 V					
<b>Rated impulse withstand voltage <math>U_{imp}</math></b>	6 kV					
<b>Electromagnetic compatibility</b>	Devices complying with IEC 60947-1 / EN 60947-1 - Environment A					
<b>Ambient air temperature</b> close to contactor	-					
Operation fitted with thermal overload relay	-					
without thermal overload relay	-40 ... +70 °C					
Storage	-60 ... +80 °C					
<b>Climatic withstand</b>	Category B according to IEC 60947-1 Annex Q					
<b>Operating altitude</b>	≤ 3000 m					
<b>Mechanical durability</b>						
Number of operating cycles	10 millions operating cycles					
Max. switching frequency	3600 cycles/h					
<b>Shock withstand</b> acc. IEC 60068-2-27 and EN 60068-2-27						
Mounting position 1						
	<b>Shock direction</b>	1/2 sinusoidal shock for 11 ms: no change in contact position				
	A	30 g				
	B1	25 g Closed position / 5 g Open position				
	B2	15 g				
	C1	25 g				
	C2	25 g				
<b>Vibration withstand</b> acc. to IEC 60068-2-6	5 ... 300 Hz 4 g Closed position / 2 g Open position					

### Magnet System Characteristics

Contactors types	AF09	AF12	AF16	AF26	AF30	AF38
<b>Coil operating limits</b> acc. to IEC 60947-4-1						
<b>AC supply</b>	at $\theta \leq 60$ °C $0.85 \times U_c \text{ min} \dots 1.1 \times U_c \text{ max}$ at $\theta \leq 70$ °C $0.85 \times U_c \text{ min} \dots U_c \text{ max}$					
<b>DC supply</b>	at $\theta \leq 60$ °C $0.85 \times U_c \text{ min} \dots 1.1 \times U_c \text{ max}$ at $\theta \leq 70$ °C (AF) $0.85 \times U_c \text{ min} \dots U_c \text{ max}$ - (AF..Z) $0.85 \times U_c \text{ min} \dots 1.1 \times U_c \text{ max}$					
<b>AC control voltage</b> Rated control circuit voltage $U_c$ 50/60 Hz	24 ... 500 V AC					
Coil consumption	<b>Average pull-in value</b> (AF) 50 VA - (AF..Z) 16 VA <b>Average holding value</b> (AF) 2.2 VA / 2 W - (AF..Z) 1.7 VA / 1.5 W					
<b>DC control voltage</b> Rated control circuit voltage $U_c$	12 ... 500 V DC					
Coil consumption	<b>Average pull-in value</b> (AF) 50 W - (AF..Z) 12 ... 16 W <b>Average holding value</b> (AF) 2 W - (AF..Z) 1.7 W					
<b>PLC-Output control</b>	(AF..Z) ≥ 500 mA 24 V DC					
<b>Drop-out voltage in % of <math>U_c</math> min.</b>	≤ 60 % $U_c$ min					
<b>Voltage sag immunity</b> according to SEMI F47-0706	(AF..Z) conditions of use on request					
<b>Dips withstand</b> (level 0% according to IEC 61000-4-11) -20 °C ≤ $\theta$ ≤ +60 °C	(AF..Z) 22 ms average for $U_c = 24 \dots 250$ V 50/60Hz					
<b>Operating time</b>						
between coil energization and:	<b>N.O. contact closing</b>	40 ... 95 ms				
	<b>N.C. contact opening</b>	38 ... 90 ms				
between coil de-energization and:	<b>N.O. contact opening</b>	11 ... 95 ms				
	<b>N.C. contact closing</b>	13 ... 98 ms				







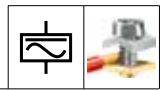







### Mounting Characteristics

Contactors types	AF09	AF12	AF16	AF26	AF30	AF38
<b>Mounting positions</b>						
<b>Mounting distances</b>	Max. N.C. built-in and add-on N.C. auxiliary contacts: see accessory fitting details for a 3-pole contactor AF09 ... AF38					
<b>Fixing</b>	The contactors can be assembled side by side.					
on rail according to IEC 60715, EN 60715	35 x 7.5 mm or 35 x 15 mm					
by screws (not supplied)	2 x M4 screws placed diagonally					

## Technical Data



### Connecting Characteristics

Contactor types	AF09	AF12	AF16	AF26	AF30	AF38
<b>Main terminals</b>						
	Screw terminals with cable clamp					
<b>Connecting capacity (min. ... max.)</b>						
<b>Main conductors (poles)</b>						
 Rigid solid ( $\leq 4 \text{ mm}^2$ )	1 x 1 ... 6 mm <sup>2</sup>		2.5 ... 10 mm <sup>2</sup>			
 Rigid stranded ( $\geq 6 \text{ mm}^2$ )	2 x 1 ... 6 mm <sup>2</sup>		2.5 ... 10 mm <sup>2</sup>			
 Flexible with non insulated ferrule	1 x 0.75 ... 6 mm <sup>2</sup>		1.5 ... 10 mm <sup>2</sup>			
 Flexible with insulated ferrule	2 x 0.75 ... 6 mm <sup>2</sup>		1.5 ... 10 mm <sup>2</sup>			
 Flexible with non insulated ferrule	1 x 0.75 ... 4 mm <sup>2</sup>		1.5 ... 10 mm <sup>2</sup>			
 Flexible with insulated ferrule	2 x 0.75 ... 2.5 mm <sup>2</sup>		1.5 ... 4 mm <sup>2</sup>			
 Bars or lugs	L < 9.6 mm		12.5 mm			
Capacity according to UL/CSA	1 or 2 x AWG 16 ... 10		AWG 14 ... 8			
Stripping length	10 mm		14 mm			
<b>Auxiliary conductors</b> (built-in auxiliary terminals + coil terminals)						
 Rigid solid	1 x 1 ... 2.5 mm <sup>2</sup>					
 Rigid stranded	2 x 1 ... 2.5 mm <sup>2</sup>					
 Flexible with non insulated ferrule	1 x 0.75 ... 2.5 mm <sup>2</sup>					
 Flexible with insulated ferrule	2 x 0.75 ... 2.5 mm <sup>2</sup>					
 Flexible with non insulated ferrule	1 x 0.75 ... 2.5 mm <sup>2</sup>					
 Flexible with insulated ferrule	2 x 0.75 ... 1.5 mm <sup>2</sup>					
 Bars or lugs	L < 8 mm					
Capacity according to UL/CSA	1 or 2 x AWG 18 ... 14					
Stripping length	10 mm					
<b>Degree of protection</b> acc. to IEC 60947-1 / EN 60947-1 and IEC 60529 / EN 60529						
Main terminals	IP20					
Coil terminals	IP20					
Built-in auxiliary terminals	IP20					
<b>Screw terminals</b>	(delivered in open position, screws of unused terminals must be tightened)					
Main terminals	M3.5		M4			
Coil terminals	M3.5					
Built-in auxiliary terminals	M3.5					
<b>Screwdriver type</b>	Flat Ø5.5 / Pozidriv 2					
<b>Tightening torque</b>						
Main pole terminals	1.5 Nm / 13 lb.in		2.5 Nm / 22 lb.in			
Coil terminals	1.2 Nm / 11 lb.in					
Built-in auxiliary terminals	1.2 Nm / 11 lb.in					

# AF09 ... AF38 3-pole Contactors

## Main Accessories



### Accessory fitting details for a 3-pole contactor AF09 ... AF38

Many configurations of accessories are possible depending on whether these are front-mounted or side-mounted.

Contactor types	Main poles	Built-in auxiliary contacts	Front-mounted accessories				Electrical and mechanical interlock set (between 2 contactors)	Side-mounted accessories	
			Auxiliary contact blocks			Auxiliary contact blocks		Left side	Right side
			1-pole CA4	2-pole CAT4-11	4-pole CA4	VEM4	2-pole CAL4-11		
			Max. N.C. built-in and add-on N.C. auxiliary contacts: 4 N.C. max. on positions 1, 2, 3, 4 and 3 N.C. max. on positions 1 ±30°, 5						
AF09 ... AF16	3	0 0 1	4 max.	or 1	or 1	-	+ 1	-	
			2 max.	-	-	-	+ 1	+ 1	
			3 max.	-	-	+ 1	+ 1	or 1	
AF09 ... AF16	3	0 1 0	4 max.	or 1	or 1	-	+ 1	-	
AF26 ... AF38	3	0 0 0	2 max.	or 1	-	-	+ 1	+ 1	
			3 max.	-	-	+ 1	+ 1	or 1	

### Mounting positions



### Protection against overloads with thermal or electronic overload relays

The addition of an overload relay on the contactor does not prevent fitting of many other accessories as shown below.

Contactor types	Overload relays - direct mounting - no kit required
AF09 ... AF38	TF42 thermal overload relay
AF09 ... AF38	EF19 electronic overload relay
AF26 ... AF38	EF45 electronic overload relay

### Contactors and main accessories (other accessories available)

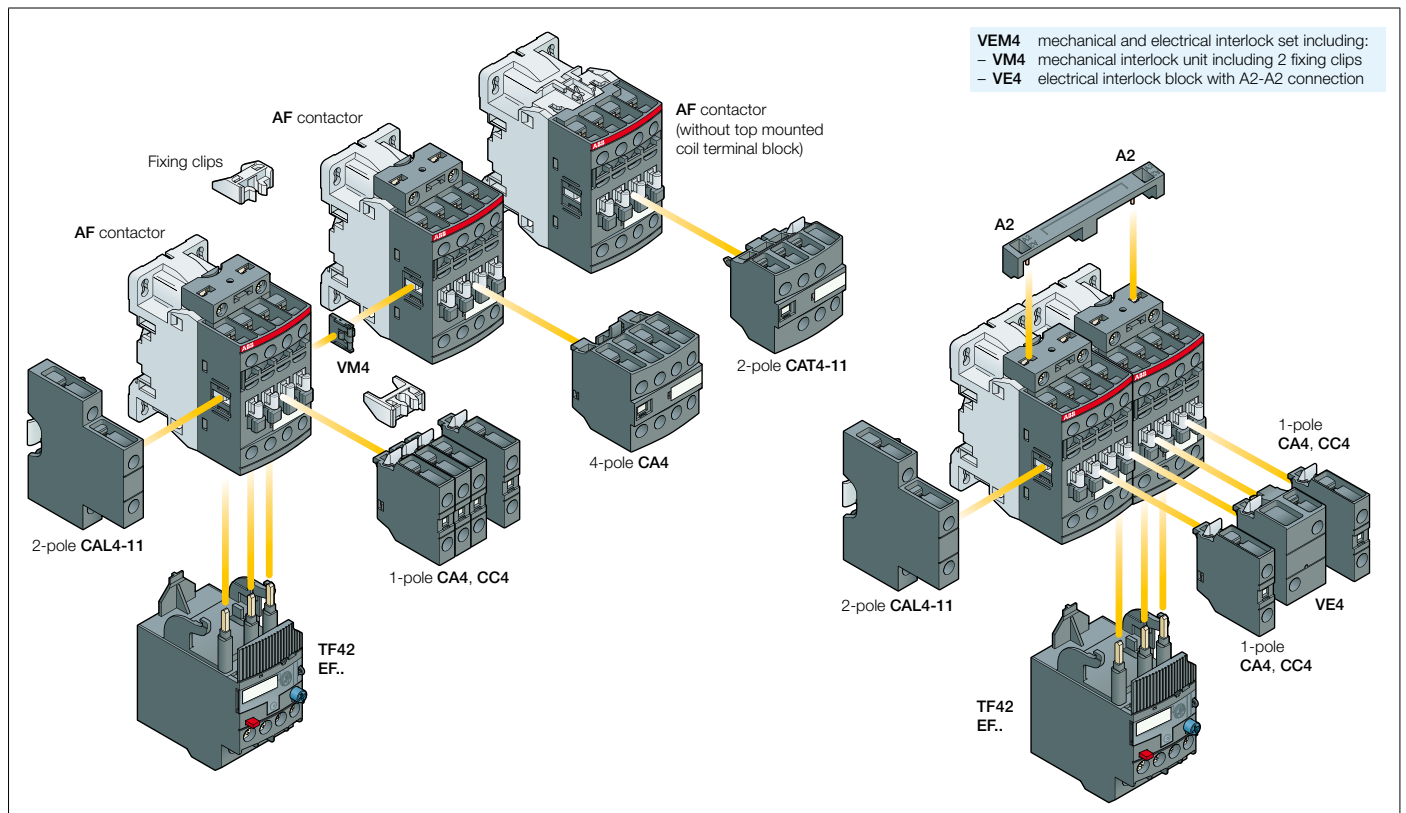

## Accessories for AF09 ... AF38 3-pole Contactors



CA4-10



CA4-22M



CAL4-11



CAT4-11E

### Application

The auxiliary contact blocks are used for the operation of auxiliary circuits and control circuits.

### Description

Types of auxiliary contact blocks for standard industrial environments:

- **CA4** 1 or 4-pole block, front-mounted, instantaneous with N.O., N.C. contacts
- **CC4** 1-pole block, front-mounted, with N.O. leading contact or N.C. lagging contact
- **CAT4** 2-pole block, front-mounted, instantaneous N.O. + N.C. contacts with A1 / A2 coil terminal connection on front face
- **CAL4** 2-pole block instantaneous N.O. + N.C. contacts clipped onto the right and/or left side of the contactors.

Select the type of 2 or 4-pole auxiliary contact blocks CAT4 or CA4-..E, CA 4-..M or CA 4-..U, according to the contactor type for compliance with the standard requirements (see terminal and marking positioning).

The auxiliary contact blocks are equipped with screw type connecting terminals delivered open, protected against accidental direct contact and bear the corresponding function marking.

Fitting Details - For each contactor refer to "Accessory Fitting Details" table.

### Ordering Details

For contactors	Auxiliary contacts	Type	Order code	Pack <sup>(ing)</sup> pieces	Weight kg (1 pce)

#### Front-mounted instantaneous auxiliary contact blocks

AF09 ... AF38	1 0 - -	CA4-10	1SBN 010 110 R1010	1	0.014
	1 0 - -	CA4-10-T	1SBN 010 110 T1010	10	0.014
	0 1 - -	CA4-01	1SBN 010 110 R1001	1	0.014
	0 1 - -	CA4-01-T	1SBN 010 110 T1001	10	0.014
AF09 ... AF16...30-10	2 2 - -	CA4-22M	1SBN 010 140 R1122	1	0.055
	3 1 - -	CA4-31M	1SBN 010 140 R1131	1	0.055
	1 3 - -	CA4-13M	1SBN 010 140 R1113	1	0.055
	0 4 - -	CA4-04M	1SBN 010 140 R1104	1	0.055
AF26 ... AF38...30-00	2 2 - -	CA4-22E	1SBN 010 140 R1022	1	0.055
	3 1 - -	CA4-31E	1SBN 010 140 R1031	1	0.055
	4 0 - -	CA4-40E	1SBN 010 140 R1040	1	0.055
	0 4 - -	CA4-04E	1SBN 010 140 R1004	1	0.055
AF09 ... AF16...30-01	2 2 - -	CA4-22U	1SBN 010 140 R1322	1	0.055
	3 1 - -	CA4-31U	1SBN 010 140 R1331	1	0.055
	4 0 - -	CA4-40U	1SBN 010 140 R1340	1	0.055

#### Front-mounted auxiliary contact blocks with N.O. leading contact and N.C. lagging contact

AF09 ... AF38	- - 1 0	CC4-10	1SBN 010 111 R1010	1	0.014
	- - 0 1	CC4-01	1SBN 010 111 R1001	1	0.014

#### Side-mounted instantaneous auxiliary contact blocks

AF09 ... AF38	1 1 - -	CAL4-11	1SBN 010 120 R1011	1	0.040
	1 1 - -	CAL4-11-T	1SBN 010 120 T1011	10	0.040

#### Front-mounted instantaneous auxiliary contact and A1/A2 coil terminal blocks

AF09 ... AF16...30-10	1 1 - -	CAT4-11M	1SBN 010 151 R1111	1	0.040
AF26 ... AF38...30-00	1 1 - -	CAT4-11E	1SBN 010 151 R1011	1	0.040
AF09 ... AF16...30-01	1 1 - -	CAT4-11U	1SBN 010 151 R1311	1	0.040

Note: CAT4 not fittable on AF.Z contactors with DC control voltage 12...20 V DC.



### Technical Data

Types	1-pole CA4, 1-pole CC4, 4-pole CA4, 2-pole CAT4, 2-pole CAL4
-------	--

### Contact Utilization Characteristics according to IEC

Standards	IEC 60947-5-1 and EN 60947-5-1	
Rated insulation voltage $U_i$ acc. to IEC 60947-5-1	690 V	
Rated impulse withstand voltage $U_{imp}$	6 kV	
Rated operational voltage $U_o$ max.	24 ... 690 V	
Conventional thermal current $I_{th}$ - $\theta \leq 40$ °C	16 A	
Rated frequency limits	25 ... 400 Hz	
Rated operational current $I_o$ / AC-15 acc. to IEC 60947-5-1	24-127 V 50/60 Hz	6 A
	220-240 V 50/60 Hz	4 A
	400-440 V 50/60 Hz	3 A
	500 V 50/60 Hz	2 A
	690 V 50/60 Hz	2 A
Making capacity acc. to IEC 60947-5-1	10 x $I_o$ AC-15 acc. to IEC 60947-5-1	
Breaking capacity acc. to IEC 60947-5-1	10 x $I_o$ AC-15 acc. to IEC 60947-5-1	
Rated operational current $I_o$ / DC-13 acc. to IEC 60947-5-1	24 V DC	6 A / 144 W
	48 V DC	2.8 A / 134 W
	72 V DC	1 A / 72 W
	110 V DC	0.55 A / 60 W
	125 V DC	0.55 A / 69 W
	220 V DC	0.27 A / 60 W
	250 V DC	0.27 A / 68 W
	400 V DC	0.15 A / 60 W
	500 V DC	0.13 A / 65 W
600 V DC	0.1 A / 60 W	
Short-circuit protection gG type fuse	10 A	
Rated short-time withstand current $I_{cw}$ $\theta = 40$ °C	for 1.0 s	100 A
	for 0.1 s	140 A
Minimum switching capacity with failure rate acc. to IEC 60947-5-4	12 V / 3 mA $10^{-7}$	
Heat dissipation per pole at 6 A	0.1 W	
Mechanical durability	Number of operating cycles	10 millions operating cycles
	Max. switching frequency	3600 cycles/h
Max. electrical switching frequency	for AC-15	1200 cycles/h
	for DC-13	900 cycles/h

### Contact Utilization Characteristics according to UL / CSA

Standards	UL 508, CSA C22.2 N°14
Rated insulation voltage $U_i$	600 V
Max. rated voltage	600 V AC, 600 V DC
Pilot duty	A600, Q600
AC thermal rated current	10 A
AC maximum volt-ampere making	7200 VA
AC maximum volt-ampere breaking	720 VA
DC thermal rated current	2.5 A
DC maximum volt-ampere making-breaking	69 VA

### Connecting Characteristics

Screw terminals	(delivered in open position, screws of unused terminals must be tightened)	
All terminals	M3.5	
Connecting capacity (min. ... max.)		
Rigid solid	1 x	1 ... 2.5 mm <sup>2</sup>
Flexible with non insulated ferrule	2 x	1 ... 2.5 mm <sup>2</sup>
Flexible with insulated ferrule	1 x	0.75 ... 2.5 mm <sup>2</sup>
Flexible with insulated ferrule	2 x	0.75 ... 2.5 mm <sup>2</sup>
Flexible with insulated ferrule	1 x	0.75 ... 2.5 mm <sup>2</sup>
Flexible with insulated ferrule	2 x	0.75 ... 1.5 mm <sup>2</sup>
Bars or lugs	L <	8 mm
Capacity acc. to UL/CSA	1 or 2 x	AWG 18 ... 14
Stripping length	10 mm	
Degree of protection acc. to IEC 60947-1 / EN 60947-1 and IEC 60529 / EN 60529	IP20	
Screwdriver type	Flat Ø5.5 / Pozidriv 2	
Tightening torque	1.2 Nm / 11 lb.in	



BEA16-4

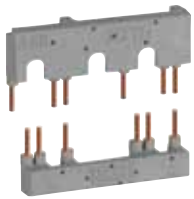
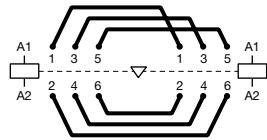

BER16-4

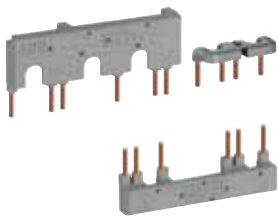
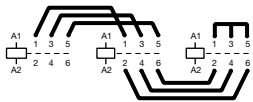

BEY16-4

### Connecting links with manual motor starters

#### Description

The **BEA..-4** connecting links are used to connect AF09 ... AF38 contactors with the MS116 or MS132 manual motor starters.

The **BEA..-4** insulated 3-pole connecting links ensure the electrical and mechanical connection between the contactor and the associated manual motor starter.

#### Ordering Details

For contactors	Type	Order code	Pack <sup>(ing)</sup> pieces	Weight kg (1 pce)
AF09 ... AF16 with MS116 and MS132	<b>BEA16-4</b>	<b>1SBN 081 306 T1000</b>	10	0.025
AF26 ... AF38 with MS132-12 ... MS132-32	<b>BEA38-4</b>	<b>1SBN 082 306 T2000</b>	10	0.030

### Connection sets for reversing contactors

#### Description

**BER16-4** and **BER38-4** connection sets between the main poles of two 3-pole contactors mounted side by side. The connection sets are made up of 1 upstream and 1 downstream connections: insulated, solid copper bars.

#### Ordering Details

For contactors	Type	Order code	Pack <sup>(ing)</sup> pieces	Weight kg (1 pce)
AF09 ... AF16	<b>BER16-4</b>	<b>1SBN 081 311 R1000</b>	1	0.045
AF26 ... AF38	<b>BER38-4</b>	<b>1SBN 082 311 R1000</b>	1	0.100

### Connection sets for Star-Delta starting

#### Description

**BEY16-4** and **BEY38-4** connection sets between the main poles of the Line, Delta and Star contactors of a Star-Delta starter.

The connection sets are made up of:

- Line contactor / Delta contactor: upstream phase-to-phase connection
- Delta contactor / Star contactor: downstream connection in parallel
- Star contactor: Star point upstream.

#### Ordering Details

For Line, Delta and Star contactors	Interlock unit between Delta & Star contactors	Type	Order code	Pack <sup>(ing)</sup> pieces	Weight kg (1 pce)
AF09 ... AF16	With or without	<b>BEY16-4</b>	<b>1SBN 081 313 R2000</b>	1	0.050
AF26 ... AF38	VM4 or VEM4	<b>BEY38-4</b>	<b>1SBN 082 713 R2000</b>	1	0.110

Accessories for AF09 ... AF38 3-pole Contactors



VM4

**Mechanical interlock unit**

**Description**

**VM4** mechanical interlock unit for the interlocking of two AF contactors. When mounted between two contactors without additional width, the VM4 mechanical interlock unit prevents one of the contactors from closing as long as the other contactor is closed. The mechanical interlock unit includes 2 fixing clips (BB4).

**Ordering Details**

For contactors	Type	Order code	Pack <sup>(ing)</sup> pieces	Weight kg (1 pce)
AF09 ... AF38	<b>VM4</b>	<b>1SBN 030 105 T1000</b>	10	0.005

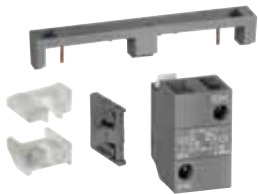

VEM4

**Mechanical and electrical interlock set**

**Description**

**VEM4** mechanical and electrical interlock set for the interlocking of two AF contactors. **VEM4** set includes a mechanical interlock unit VM4 with 2 fixing clips (BB4) and a VE4 electrical interlock block with A2-A2 connection. Fixing the electrical interlock block to the contactor front face connects the 2 built-in N.C. interlocking contacts with the two coils. VE4 block must be used with A2-A2 connection to respect the electrical connection diagram.

**Ordering Details**

For contactors	Auxiliary contacts	Type	Order code	Pack <sup>(ing)</sup> pieces	Weight kg (1 pce)
AF09 .. AF16 AF26 .. AF38	1 1	<b>VEM4</b>	<b>1SBN 030 111 R1000</b>	1	0.035

Note: VEM4 not fittable on AF..Z contactors with DC control voltage 12...20 V DC.

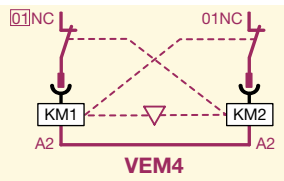

**Fixing clips**

**Ordering Details**

For contactors	Type	Order code	Pack <sup>(ing)</sup> pieces	Weight kg (1 pce)
AF09 ... AF38	<b>BB4</b>	<b>1SBN 110 120 W1000</b>	50	0.002



BB4

## Accessories for AF09 ... AF38 3-pole Contactors



## Technical Data

<b>Interlock types</b>	<b>VM4</b>
<b>Mechanical durability</b>	
Number of operating cycles	5 millions operating cycles
Max. switching frequency	1800 cycles/h

<b>Interlock types</b>	<b>VEM4</b>
------------------------	-------------







## Contact Utilization Characteristics according to IEC

<b>Standards</b>	IEC 60947-5-1 and EN 60947-5-1
<b>Rated insulation voltage <math>U_i</math> acc. to IEC 60947-5-1</b>	690 V
<b>Rated impulse withstand voltage <math>U_{imp}</math></b>	6 kV
<b>Rated control circuit voltage <math>U_c</math></b>	
AC 50/60 Hz control voltage	24 ... 500 V AC
DC control voltage	20 ... 500 V DC
<b>Conventional thermal current <math>I_{th} - \theta \leq 40 \text{ °C}</math></b>	16 A
<b>Mechanical and electrical durability</b>	
Number of operating cycles	5 millions operating cycles
Max. mechanical switching frequency	1800 cycles/h
Max. electrical switching frequency	1200 cycles/h

## Contact Utilization Characteristics according to UL / CSA

<b>Standards</b>	UL 508, CSA C22.2 N°14
<b>Max. rated voltage</b>	500 V AC, 500 V DC

## Connecting Characteristics

<b>Screw terminals</b>	
All terminals	M3.5
<b>Connecting capacity (min. ... max.)</b>	
 Rigid Solid	1 x ; 1 ... 2.5 mm <sup>2</sup>
 Rigid Solid	2 x ; 1 ... 2.5 mm <sup>2</sup>
 Flexible with non insulated ferrule	1 x ; 0.75 ... 2.5 mm <sup>2</sup>
 Flexible with non insulated ferrule	2 x ; 0.75 ... 2.5 mm <sup>2</sup>
 Flexible with insulated ferrule	1 x ; 0.75 ... 2.5 mm <sup>2</sup>
 Flexible with insulated ferrule	2 x ; 0.75 ... 1.5 mm <sup>2</sup>
 Bars or lugs	L < ; 8 mm
Capacity according to UL/CSA	1 or 2 x ; AWG 18 ... 14
Stripping length	10 mm
<b>Degree of protection</b>	
acc. to IEC 60947-1 / EN 60947-1 and IEC 60529 / EN 60529	IP20
<b>Screwdriver type</b>	Flat Ø5.5 / Pozidriv 2
<b>Tightening torque</b>	1.2 Nm / 11 lb.in



Accessories for AF09 ... AF38 3-pole Contactors



LDC4

**Additional coil terminal block**

**Description**

Additional coil terminal block for a bottom access to the coil terminals of contactors or contactor relays.

**Ordering Details**

For contactors	Type	Order code	Pack <sup>(ing)</sup> pieces	Weight kg (1 pce)
AF09 ... AF38	LDC4	1SBN 070 156 T1000	10	0.010



BX4



BX4-CA

**Protective covers**

**Description**

Sealable and transparent protective covers BX4 and non-removable BX4-CA to protect the devices against accidental contact.

**Ordering Details**

For contactors	Type	Order code	Pack <sup>(ing)</sup> pieces	Weight kg (1 pce)
All 1-stack contactors	BX4	1SBN 110 108 T1000	10	0.006
For 4-pole CA4 and 2-pole CAT4 auxiliary contact blocks	BX4-CA	1SBN 110 109 W1000	50	0.001

**Function markers**

**Description**

Box of 16 blank cards (16 markers by card) printable on HTP500 thermal transfer printer and AMS 500 marking table to identify your contactors, overload relays or manual motor starters.

Marker dimensions: 7 x 20 mm (.276" x .787")



BA4

**Ordering Details**

For contactors	Type	Order code	Pack <sup>(ing)</sup> pieces	Weight kg (1 pce)
Marker card	BA4	1SNA 235 156 R2700	16	0.011
AMS 500 support plate for 8 BA4	SPRC 1	1SNA 360 010 R1500	1	0.220
HTP500 support plate	HTP500-BA4	1SNA 235 712 R2400	1	0.290

# AF09 ... AF38 3-pole Contactors

## Terminal Marking and Positioning



### Standard devices without addition of auxiliary contacts

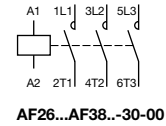
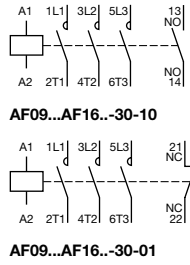
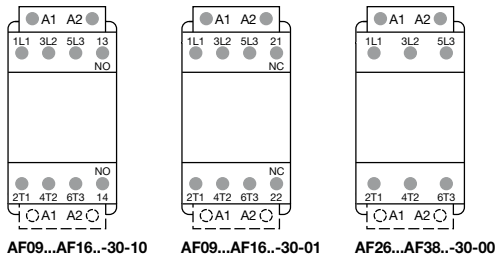

### Other possible contact combinations with auxiliary contacts added by the user

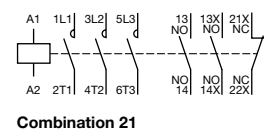
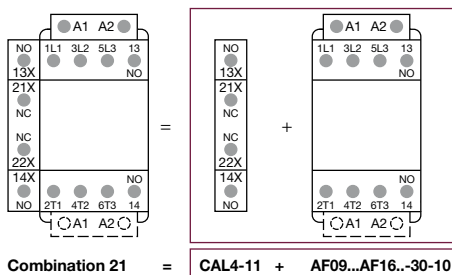
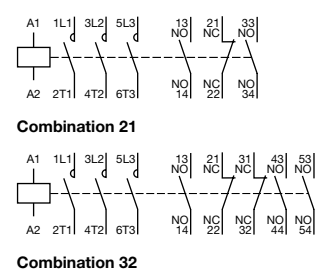
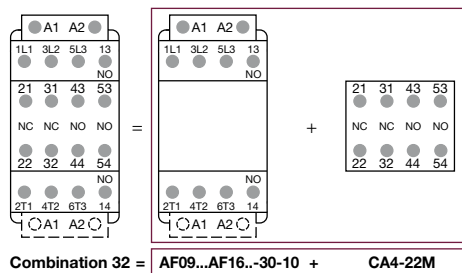
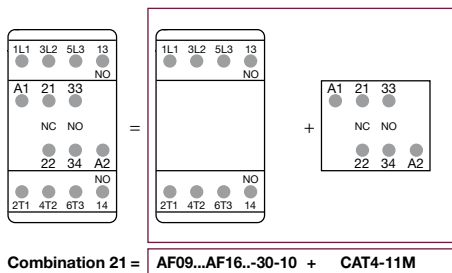
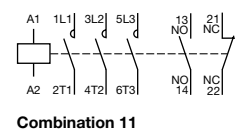
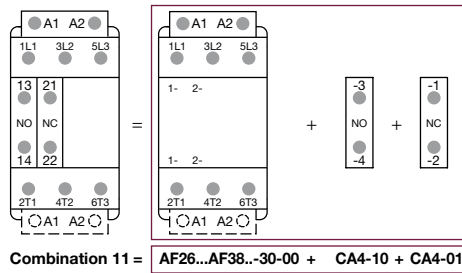
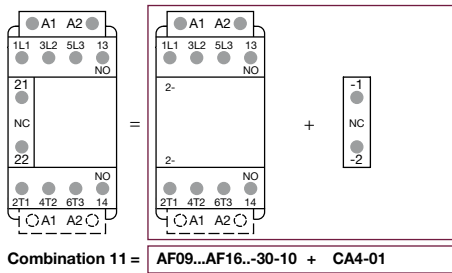

Note: Only AF.Z contactor with DC control voltage 12...20 V DC need to respect the connection polarities indicated close to the coil terminals: A1+ for the positive pole and A2- for the negative pole

# Add-on Auxiliary Contacts

## Terminal Marking and Positioning



### 1-pole auxiliary contacts

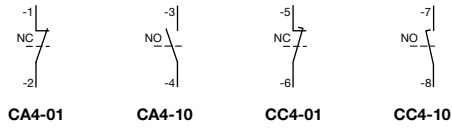

### 2-pole auxiliary contacts

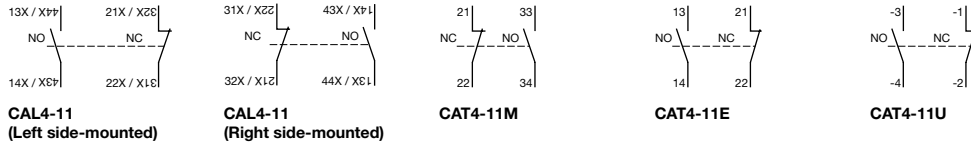

### 4-pole auxiliary contacts

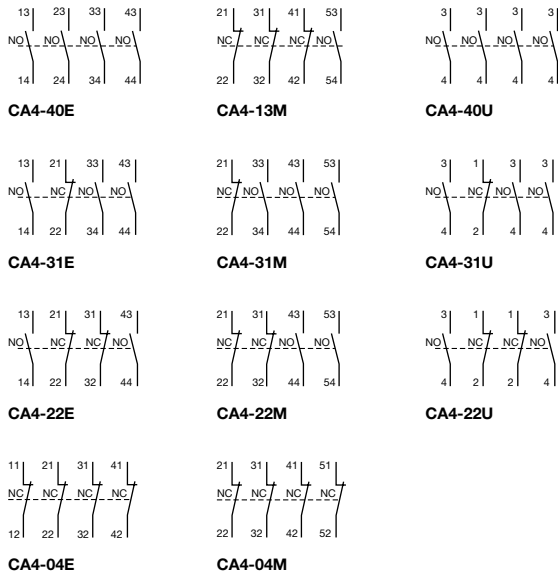

# AF09 ... AF16 3-pole Contactors

## AC / DC Operated - with Screw Terminals



### Dimensions mm, inches

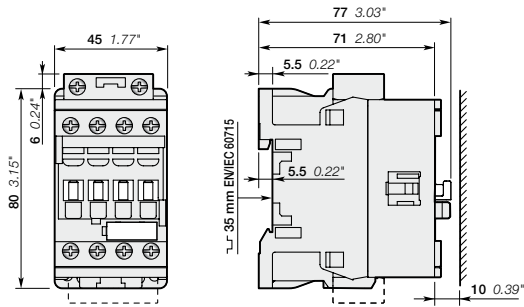

AF09, AF12, AF16

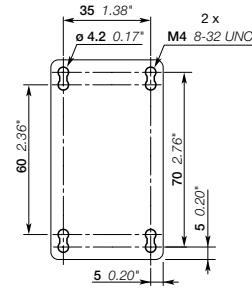

AF09, AF12, AF16

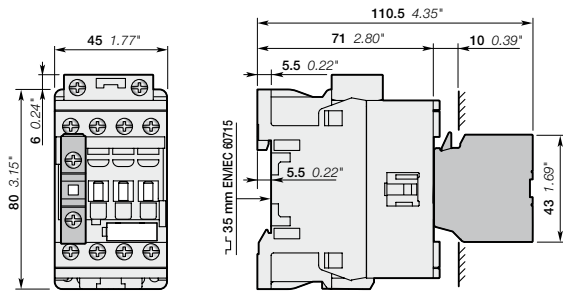

AF09, AF12, AF16  
+ CA4, CC4 1-pole auxiliary contact block

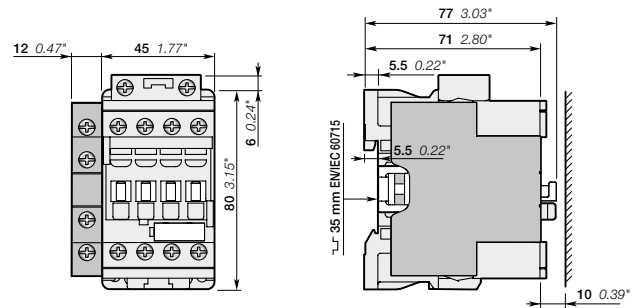

AF09, AF12, AF16  
+ CAL4-11 2-pole auxiliary contact block

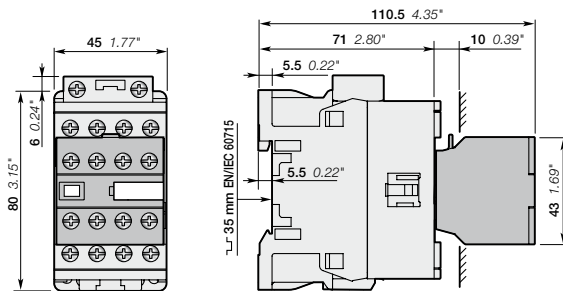

AF09, AF12, AF16  
+ CA4 4-pole auxiliary contact block

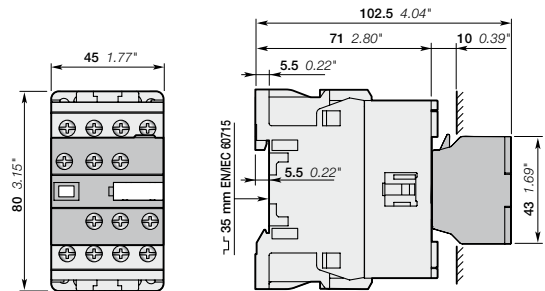

AF09, AF12, AF16  
+ CAT4 2-pole auxiliary contact and coil terminal block

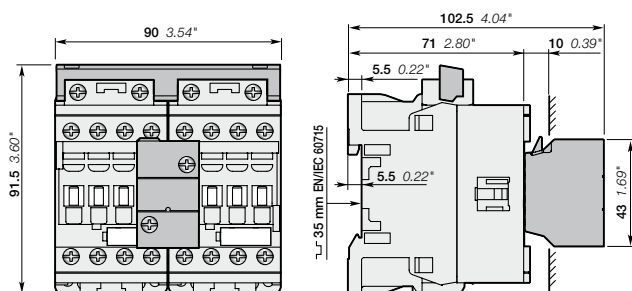

AF09, AF12, AF16  
+ VEM4 mechanical and electrical interlock set

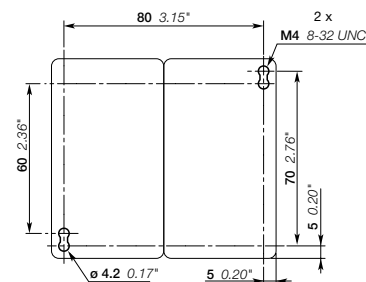

AF09, AF12, AF16  
+ VEM4 mechanical and electrical interlock set

Note: contactor lateral distance to grounded component 2 mm 0.08" min.

# AF26 ... AF38 3-pole Contactors

## AC / DC Operated - with Screw Terminals



Dimensions mm, inches

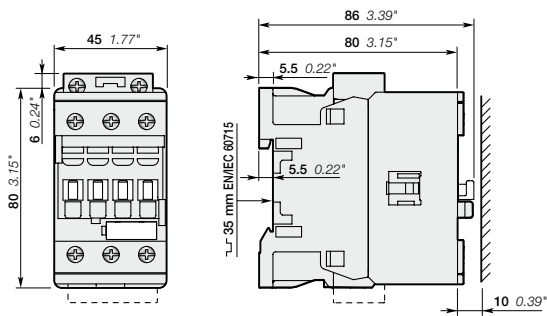

AF26, AF30, AF38

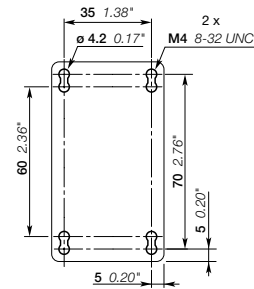

AF26, AF30, AF38

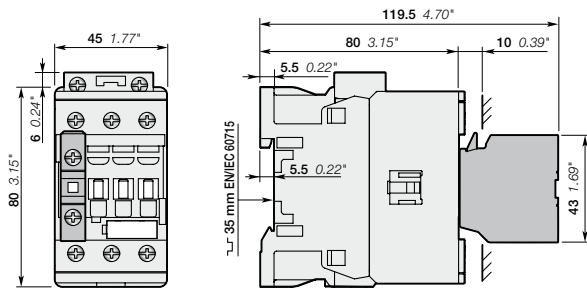

AF26, AF30, AF38  
+ CA4, CC4 1-pole auxiliary contact block

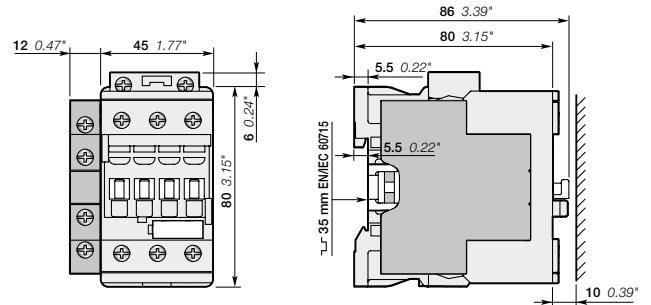

AF26, AF30, AF38  
+ CAL4-11 2-pole auxiliary contact block

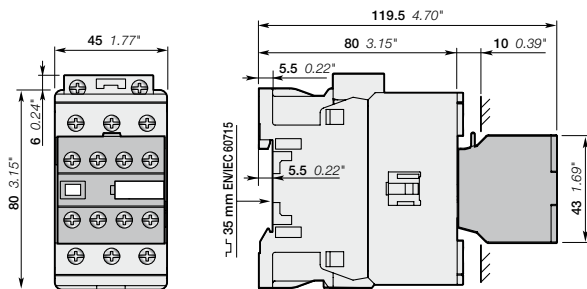

AF26, AF30, AF38  
+ CA4 4-pole auxiliary contact block

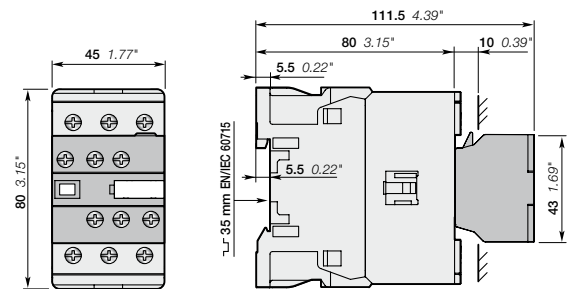

AF26, AF30, AF38  
+ CAT4 2-pole auxiliary contact and coil terminal block

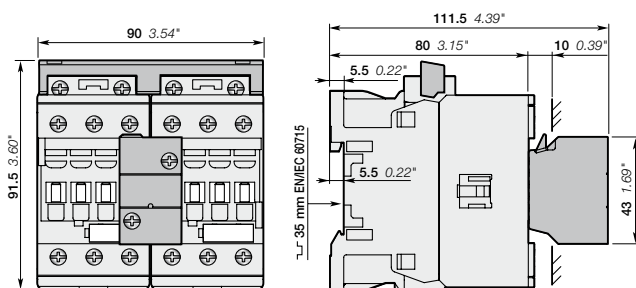

AF26, AF30, AF38  
+ VEM4 mechanical and electrical interlock set

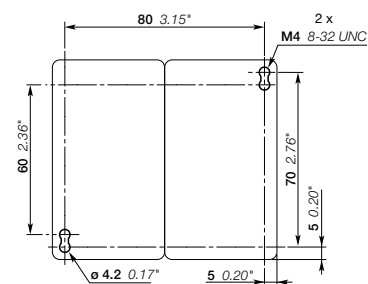

AF26, AF30, AF38  
+ VEM4 mechanical and electrical interlock set

Note: contactor lateral distance to grounded component 2 mm 0.08" min.

## X-ON Electronics

Largest Supplier of Electrical and Electronic Components

*Click to view similar products for [abb manufacturer](#):*

Other Similar products are found below :

[TV10-516R](#) [017667013](#) [RF727](#) [2CMA100178R1000](#) [5SDD 92Z0401](#) [ESV14-BS](#) [EZS-21-250](#) [F204AC-40/0.03](#) [F362-25/0.03](#)

[GJL1211001R0011](#) [GJL1211201R8000](#) [GJL1211501R8000](#) [GJL1213001R0017](#) [GJL1213001R0101](#) [GJL1311001R0101](#) [GJL1311001R8010](#)

[GJL1311201R0001](#) [GJL1313001R0011](#) [GJL1313001R0101](#) [GJL1317201R0001](#) [AF09-30-01-11](#) [AF460-30-11-68](#) [1455](#) [EF45-30](#) [ERG297](#)

[HSC2-20](#) [1SAM201904R1001](#) [1SAM350000R1003](#) [1SAZ721201R1009](#) [1SAZ721201R1014](#) [1SAZ721201R1025](#) [1SFA611101R1002](#)

[1SFA611130R1103](#) [1SFA611131R1101](#) [1SFA611143R1101](#) [1SFA611202R1108](#) [1SFA611203R1108](#) [1SFA611215R1001](#)

[1SFA611216R1108](#) [1SFA611285R1002](#) [1SFA611702R6006](#) [1SFA616162R1025](#) [1SFA619100R3015](#) [1SVR730020R0200](#) [IPC4111](#)

[OS30FACC12](#) [OS60GJ03](#) [OVR1N160277PS](#) [OXC1L48](#) [254](#)