



Features

- Two channel quadrature output
- Bushing or servo mount
- Square wave signal
- Small size
- Resolution to 256 PPR
- CMOS and TTL compatible
- Long life
- Ball bearing option for high operating speed up to 3000 rpm
- RoHS compliant*

EN - Rotary Optical Encoder

Electrical Characteristics

| | |
|--|--|
| Output | 2-bit quadrature code, Channel A leads Channel B by 90° (electrical) with clockwise rotation |
| Resolution | 25 to 256 cycles per revolution |
| Insulation Resistance (500 VDC) | 1,000 megohms |
| Electrical Travel | Continuous |
| Supply Voltage | 5.0 VDC ±0.25 VDC |
| Supply Current | 26 mA maximum |
| Output Voltage | |
| Low Output | 0.8 V maximum |
| High Output | 4 V minimum |
| Output Current | |
| Low Output | 25 mA minimum |
| Rise/Fall Time | 200 ns (typical) |
| Shaft RPM (Ball Bearing) | 3,000 rpm maximum |
| Power Consumption | 136 mW maximum |
| Pulse Width (Electrical Degrees, Each Channel) | 180° ±45° typ. |
| Pulse Width (Index Channel) | 360° ±90° |
| Phase (Electrical Degrees, Channel A to Channel B) | 90° ±45° typ. |

Environmental Characteristics

| | |
|---|---------------------------------------|
| Operating Temperature Range | -40 °C to +75 °C (-40 °F to +167 °F) |
| Storage Temperature Range | -40 °C to +85 °C (-40 °F to +185 °F) |
| Humidity | MIL-STD-202, Method 103B, Condition B |
| Vibration | 5 G |
| Shock | 50 G |
| Rotational Life | |
| A & C Bushings (300 rpm maximum)** | 10,000,000 revolutions |
| W, S & T Bushings (3,000 rpm maximum)** | 200,000,000 revolutions |
| IP Rating | IP 40 |

Mechanical Characteristics

| | |
|---|--|
| Mechanical Angle | 360° Continuous |
| Torque (Starting and Running) | |
| A & C Bushings (Spring Loaded for Optimum Feel) | 1 N-cm (1.5 oz-in.) maximum |
| W, S & T Bushings (Ball Bearing Shaft Support) | 0.07 N-cm (0.1 oz-in.) maximum |
| Mounting Torque | 1.7 to 2.0 N-m (15 to 18 lb.-in.) maximum |
| Shaft End Play | 0.30 mm (0.012") T.I.R. maximum |
| Shaft Radial Play | 0.12 mm (0.005") T.I.R. maximum |
| Weight | 11 gms. (0.4 oz.) |
| Terminals | Axial or radial pc pins or ribbon cable |
| Soldering Condition | |
| Manual Soldering | 96.5Sn/3.0Ag/0.5Cu solid wire or no-clean rosin cored wire 370 °C (700 °F) max. for 3 seconds |
| Wave Soldering | 96.5Sn/3.0Ag/0.5Cu solder with no-clean flux 260 °C (500 °F) max. for 5 seconds |
| Wash processes | Not recommended |
| Marking | Manufacturer's trademark, name, part number, and date code. |
| Hardware | One lockwasher and one mounting nut supplied with each encoder, except on servo mount versions. |

**For resolutions ≤ 128 quadrature cycles per shaft revolution.

Quadrature Output Table

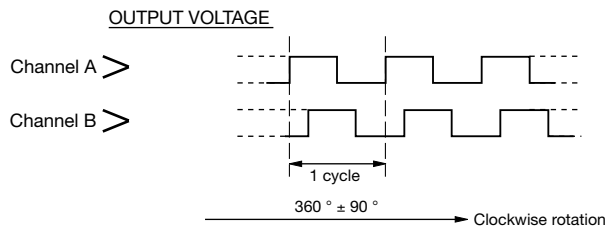

STANDARD RESOLUTIONS AVAILABLE

| | |
|--|-----|
| (Full quadrature output cycles per shaft revolution) | |
| 25* | 125 |
| 50* | 128 |
| 64 | 200 |
| 100 | 256 |

For Non-Standard Resolutions—Consult Factory

* Channel B leads Channel A

*RoHS Directive 2002/95/EC Jan. 27, 2003 including annex and RoHS Recast 2011/65/EU June 8, 2011.

Specifications are subject to change without notice.

The device characteristics and parameters in this data sheet can and do vary in different applications and actual device performance may vary over time.

Users should verify actual device performance in their specific applications.

EN - Rotary Optical Encoder

Dimensional Drawings

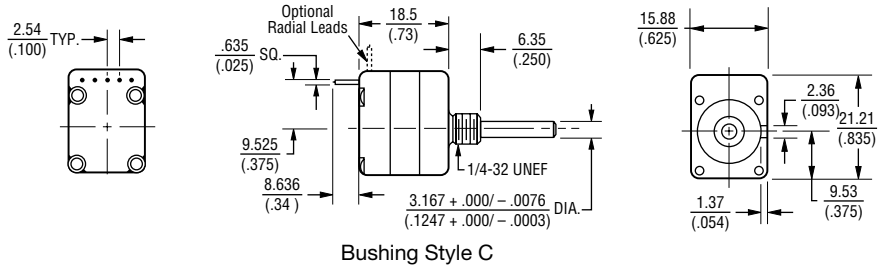

Consult factory for options not shown, including:

- Wire lead or cable options
- Connectors
- Non-standard resolutions
- Special shaft/bushing sizes and features
- Special performance characteristics
- PCB mounting bracket

Bushing Style C

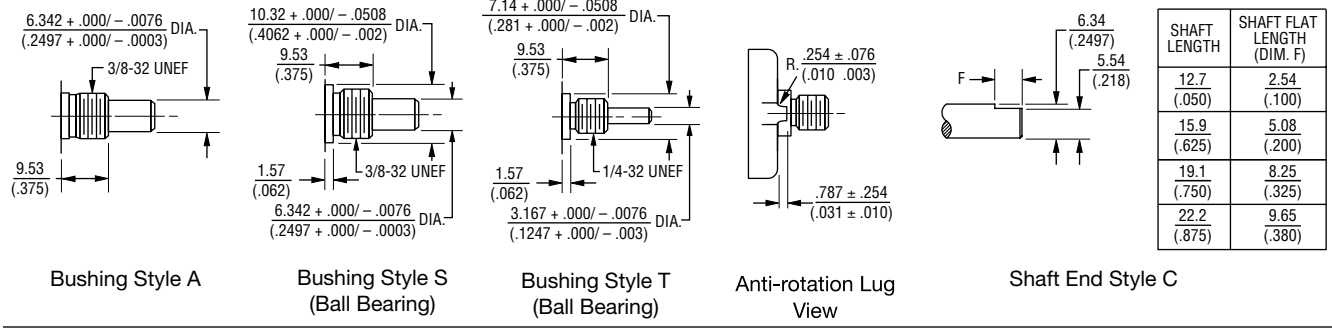

TERMINATION DIAGRAM

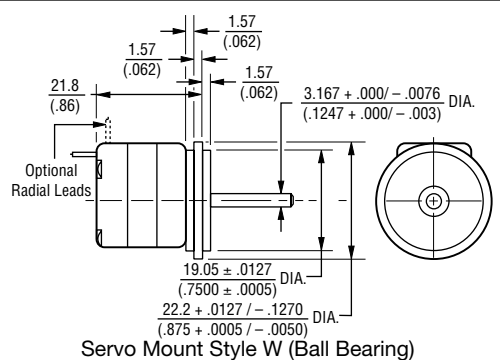
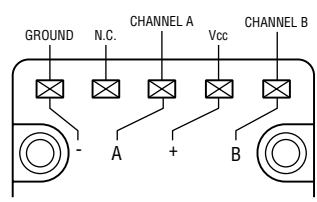

Servo Mount Style W (Ball Bearing)

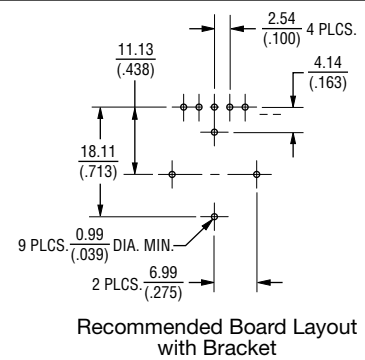

Recommended Board Layout with Bracket

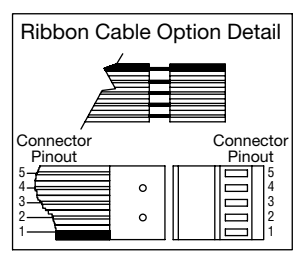
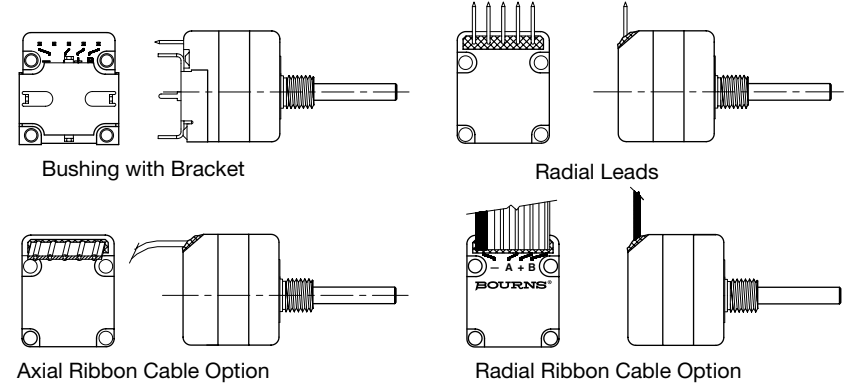

DIMENSIONS: $\frac{\text{MM}}{\text{(INCHES)}}$

Specifications are subject to change without notice. The device characteristics and parameters in this data sheet can and do vary in different applications and actual device performance may vary over time. Users should verify actual device performance in their specific applications.

GENERAL INFORMATION

The Bourns® EN model is a self-contained rotary optical encoder. It produces a 2-bit quadrature signal which is suitable for digital systems where both magnitude and direction of adjustment must be provided. The EN encoder is ideal for use as a digital panel control or as a position sensing device in applications where long life, reliability, high resolution and precise linearity are critical.

The EN series encoder converts rotary input into electrical signals which can be used by microprocessors without A/D conversion.

Bourns encoder output signals are square wave digital pulses which do not require debounce circuitry. Both features make it possible to significantly reduce the memory overhead, wiring and wiring interconnects required by other types of control devices.

EN optical encoders offer a useful rotational life of from 10 million to 200 million shaft revolutions, making them ideal for extended service applications. The Bourns encoder is also compact and well suited for situations where the available space is limited.

EN - Rotary Optical Encoder

BOURNS®

How To Order

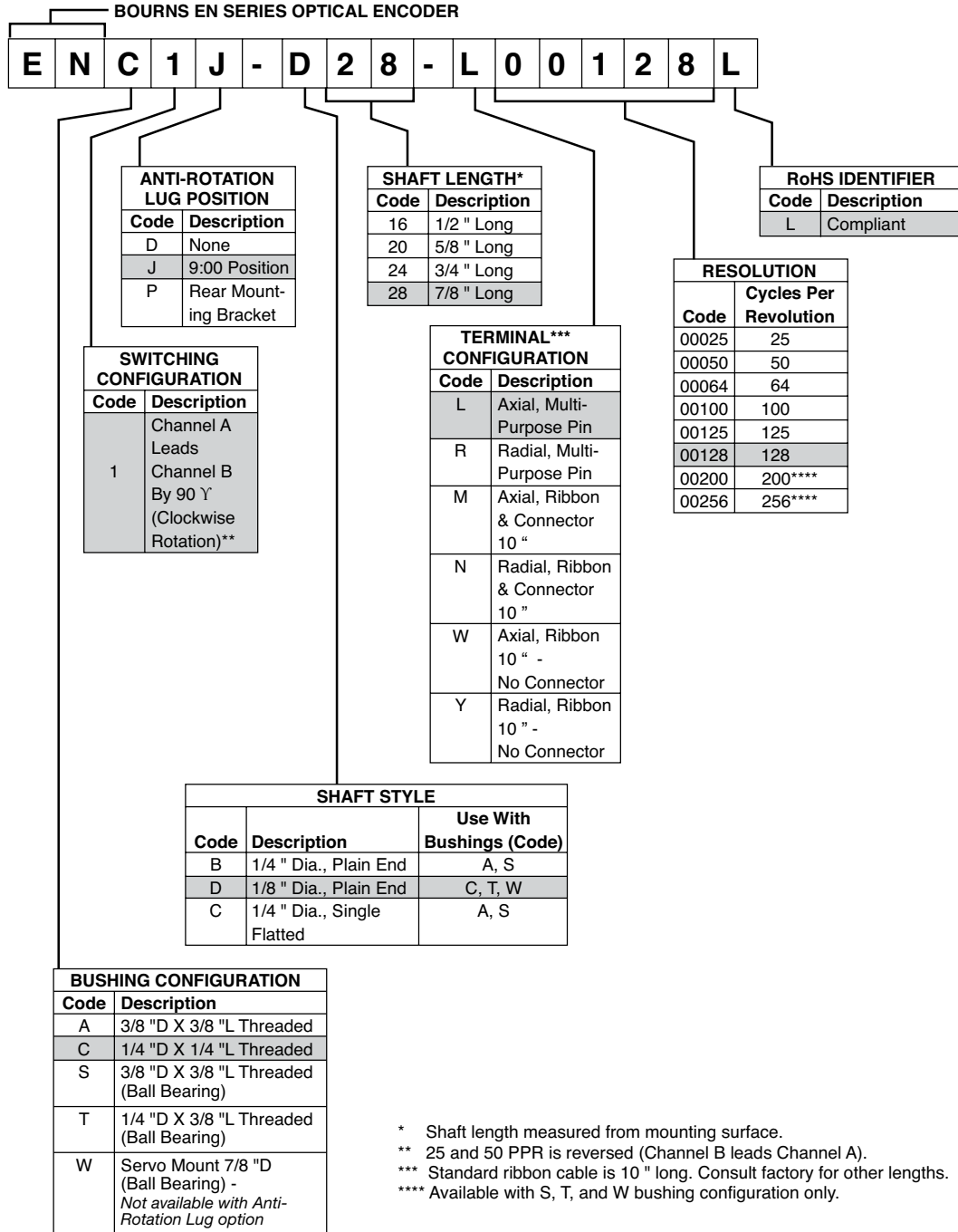

* Shaft length measured from mounting surface.

** 25 and 50 PPR is reversed (Channel B leads Channel A).

*** Standard ribbon cable is 10 " long. Consult factory for other lengths.

**** Available with S, T, and W bushing configuration only.

REV. 01/17

Specifications are subject to change without notice.

The device characteristics and parameters in this data sheet can and do vary in different applications and actual device performance may vary over time. Users should verify actual device performance in their specific applications.

X-ON Electronics

Largest Supplier of Electrical and Electronic Components

Click to view similar products for [Encoders](#) category:

Click to view products by [Bourns](#) manufacturer:

Other Similar products are found below :

[6-1393048-5](#) [62AG22-H5-P](#) [62B22-LP-030C](#) [62D22-02-P](#) [62R22-01-040S](#) [63K25](#) [63K32](#) [63KS100](#) [63KS64](#) [63R100](#) [63R50-020](#) [63RS256-060](#) [700-09-36](#) [E6C2-CWZ6C-10 500P/R 5M](#) [E6C3-CWZ5GH 1000P/R 2M](#) [25LB22-G-Z](#) [T101-5C2-111-M1](#) [T101-5C3-111-M1](#) [T101-5C4-111-M1](#) [25LB45-Q-Z](#) [HEDS-8905](#) [385001M0439](#) [385001M0216](#) [DPL12SV2424A25K3](#) [E69-1](#) [E69-DF15](#) [E69-FBA-02](#) [E69-FCA](#) [E6B2-CWZ1X 2000P/R 0.5M](#) [E6B2-CWZ3E 600P/R 0.5M](#) [E6C3-CWZ3EH 800P/R 2M](#) [ENA1D-472-L00050L](#) [61S64-2](#) [62B11-LP-100S](#) [62B11-LPP-P](#) [62C1111-02-020C](#) [62N11-P](#) [62S22-H9-120S](#) [62S30-L0-200C](#) [62V15-02-080S](#) [62V22-02-030C](#) [632911-128](#) [63K64](#) [63KS100-040](#) [63R64-050](#) [63RS256](#) [63RS64](#) [700-16-16](#) [3-1393048-1](#) [63KS128](#)