

Film Capacitors

Metallized Polypropylene Film Capacitors (MKP)

Series/Type: B32651 ... B32658

Date: March 2017

© EPCOS AG 2017. Reproduction, publication and dissemination of this publication, enclosures hereto and the information contained therein without EPCOS' prior express consent is prohibited.

EPCOS AG is a TDK Group Company.

High pulse (wound)**Typical applications**

- Electronic ballasts
- Switch-mode power supplies
- IGBT
- Snubbing

Climatic

- Max. operating temperature: 110 °C
- Climatic category (IEC 60068-1): 55/100/56

Construction

- Dielectric: polypropylene (PP)(MKP)
- Wound capacitor technology with internal series connection
- Plastic case (UL 94 V-0)
- Epoxy resin sealing (UL 94 V-0)

Features

- High pulse strength
- High contact reliability
- RoHS-compatible
- Very low inductance
- Halogen-free capacitors available on request

Terminals

- Parallel wire leads, lead-free tinned
- Special lead lengths available on request

Marking

Manufacturer's logo,
lot number ($\square \leq 27.5$ mm), series number (e.g. 651),
rated capacitance (coded), cap. tolerance (code letter),
rated DC voltage (AC voltage for 1600 V DC/700 V AC
and 2000 V DC/1000 V AC),
date of manufacture (coded)

Delivery mode

Bulk (untaped)

Taped (Ammo pack or reel)

For notes on taping, refer to chapter "Taping and packing".



Dimensional drawings

Number of wires	Lead spacing e ± 0.4	Lead diameter d_1 ± 0.05	Type	Drawing
2-pin	10	0.6	B32651	A1
2-pin	15	0.8	B32652	A1
2-pin	22.5	0.8	B32653	A1
2-pin	27.5	0.8	B32654	A1
2-pin	37.5	1.0	B32656A/J	A1
2-pin	37.5	1.0	B32656T	A2
4-pin	37.5	1.2	B32656G	B1
4-pin	52.5	1.2	B32658G	B1

(Dimensions in mm)

Dimensional drawings 2-pin versions

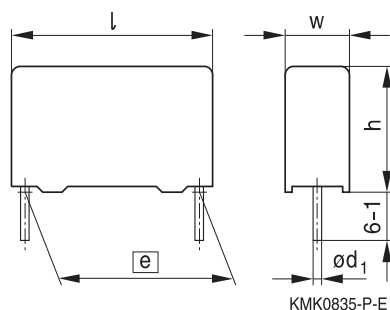
Drawing A1



	B32651	B32652	B32653	B32654	B32656A/J
Lead spacing e ± 0.4 :	10	15	22.5	27.5	37.5
Lead diameter d_1 :	0.6	0.8	0.8	0.8	1.0

(Dimensions in mm)



B32651 ... B32658

High pulse (wound)

Drawing A2 (low profile)

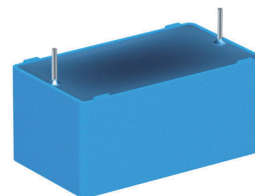

Lead spacing $e \pm 0.4$:	37.5
Lead diameter d_1 :	1.0

(Dimensions in mm)

Dimensional drawings 4-pin versions

Drawing B1

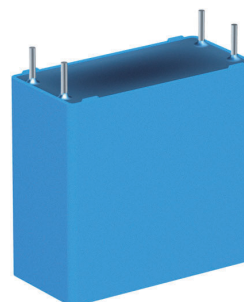

	B32656G	B32658G
Lead spacing $e \pm 0.4$:	37.5	52.5
Lead diameter d_1 :	1.2	1.2

(Dimensions in mm)

B32651 ... B32658

High pulse (wound)



Overview of available types

Lead spacing	10 mm
Type	B32651
Page	12
V_R (V DC)	1250
V_{RMS} (V AC)	450
C_R (nF)	
2.2	
3.3	
4.7	
6.8	



B32651 ... B32658

High pulse (wound)

Overview of available types

Lead spacing	15 mm							
Type	B32652							
Page	13							
V_R (V DC)	250	400	630	1000	1250	1600	1600	2000
V_{RMS} (V AC)	160	200	250	250	500	500	700	700
C_R (nF)								
1.0								
1.5								
2.2								
3.3								
4.7								
5.6								
6.8								
10								
12								
15								
22								
33								
47								
56								
68								
100								
120								
150								
220								
330								
390								
470								
560								
680								
820								
1000								

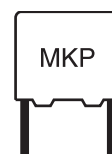

Overview of available types

Lead spacing	22.5 mm							
Type	B32653							
Page	16							
V_R (V DC)	250	400	630	1000	1250	1600	2000	2000
V_{RMS} (V AC)	160	200	250	250	500	500	700	1000
C_R (nF)								
2.2								
3.3								
4.7								
6.8								
10								
12								
15								
22								
33								
47								
56								
68								
82								
100								
120								
150								
220								
330								
470								
560								
680								
1000								
1200								
1500								
2200								
3300								



B32651 ... B32658

High pulse (wound)

Overview of available types

Lead spacing	27.5 mm						
Type	B32654						
Page	19						
V_R (V DC)	250	400	630	1000	1250	1600	2000
V_{RMS} (V AC)	160	200	250	250	500	500	700
C_R (nF)							
22							
33							
47							
68							
82							
100							
150							
220							
330							
470							
560							
680							
820							
1000							
1200							
1500							
2200							
2700							
3300							
4700							
5600							
6800							
8200							



Overview of available types

Lead spacing	37.5 mm			
Type	B32656			
Page	21			
V_R (V DC)	250	400	630	750
V_{RMS} (V AC)	160	200	250	350
C_R (nF)				
470				
560				
680				
820				
1000				
1200				
1500				
1800				
2000				
2200				
2500				
2700				
3000				
3300				
3500				
4000				
4700				
5600				
6800				
7000				
7500				
8000				
10000				
12000				
14000				
15000				
17000				
20000				
24000				



B32651 ... B32658

High pulse (wound)

Overview of available types

Lead spacing	37.5 mm				
Type	B32656				
Page	24				
V_R (V DC)	850	1000	1250	1600	2000
V_{RMS} (V AC)	450	500	500	600	700
C_R (nF)					
68					
100					
120					
150					
220					
270					
330					
390					
470					
560					
680					
820					
900					
1000					
1200					
1500					
1800					
2200					
2500					
2700					
3000					
3300					
3800					



Overview of available types

Lead spacing	52.5 mm								
Type	B32658								
Page	28								
V_R (V DC)	250	400	630	750	850	1000	1250	1600	2000
V_{RMS} (V AC)	160	200	250	350	450	500	500	600	700
C_R (nF)									
680									
820									
1000									
1200									
1500									
2000									
2200									
2700									
3300									
4500									
4700									
5600									
6000									
6800									
9000									
12000									
15000									
20000									
26000									
30000									
40000									



B32651

High pulse (wound)

Ordering codes and packing units (lead spacing 10 mm)

V_R	V_{RMS} $f \leq 1$ kHz	C_R	Max. dimensions $w \times h \times l$	Ordering code (composition see below)	Straight terminals, Ammo pack pcs./MOQ	Straight terminals, Reel pcs./MOQ	Straight terminals, Untaped pcs./MOQ
V DC ¹⁾	V AC	nF	mm				
1250	450	2.2	4.0 × 9.0 × 13.0	B32651A7222+***	4000	6800	4000
		3.3	5.0 × 11.0 × 13.0	B32651A7332+***	3320	5200	4000
		4.7	5.0 × 11.0 × 13.0	B32651A7472+***	3320	5200	4000
		6.8	6.0 × 12.0 × 13.0	B32651A7682+***	2720	4400	4000

MOQ = Minimum Order Quantity, consisting of 4 packing units.
Further E series and intermediate capacitance values on request.

Composition of ordering code

+ = Capacitance tolerance code:

K = ±10%

J = ±5%

*** = Packaging code:

289 = Straight terminals, Ammo pack

189 = Straight terminals, Reel

000 = Straight terminals, Untaped (standard lead length 6 –1 mm)

1) For pulse loads (pulse width ≤ 1000 μs), a peak voltage of 1400 V_p can be permitted.

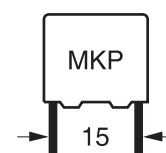
Ordering codes and packing units (lead spacing 15 mm)

V_R	V_{RMS} $f \leq 1$ kHz	C_R	Max. dimensions $w \times h \times l$	Ordering code (composition see below)	Straight terminals, Ammo pack pcs./MOQ	Straight terminals, Reel pcs./ MOQ	Straight terminals, Untaped pcs./ MOQ
V DC	V AC	nF	mm				
250	160	150	5.0 × 10.5 × 18.0	B32652A3154+***	4680	5200	4000
		220	6.0 × 11.0 × 18.0	B32652A3224+***	3840	4400	4000
		330	7.0 × 12.5 × 18.0	B32652A3334+***	3320	3600	1000
		470	8.5 × 14.5 × 18.0	B32652A3474+***	2720	2800	2000
		680	9.0 × 17.5 × 18.0	B32652A3684+***	2560	2800	2000
		820	11.0 × 18.5 × 18.0	B32652A3824+***	–	2200	1200
		1000	11.0 × 18.5 × 18.0	B32652A3105+***	–	2200	1200
400	200	68	5.0 × 10.5 × 18.0	B32652A4683+***	4680	5200	4000
		100	5.0 × 10.5 × 18.0	B32652A4104+***	4680	5200	4000
		150	6.0 × 11.0 × 18.0	B32652A4154+***	3840	4400	4000
		220	7.0 × 12.5 × 18.0	B32652A4224+***	3320	3600	4000
		330	8.5 × 14.5 × 18.0	B32652A4334+***	2720	2800	2000
		470	9.0 × 17.5 × 18.0	B32652A4474+***	2560	2800	2000
		560	11.0 × 18.5 × 18.0	B32652A4564+***	–	2200	1200
		680	11.0 × 18.5 × 18.0	B32652A4684+***	–	2200	1200
630	250	33	5.0 × 10.5 × 18.0	B32652A6333+***	4680	5200	4000
		47	5.0 × 10.5 × 18.0	B32652A6473+***	4680	2800	4000
		68	6.0 × 11.0 × 18.0	B32652A6683+***	3840	4400	4000
		100	7.0 × 12.5 × 18.0	B32652A6104+***	3320	3600	4000
		150	8.5 × 14.5 × 18.0	B32652A6154+***	2720	2800	2000
		220	9.0 × 17.5 × 18.0	B32652A6224+***	2560	2800	2000
		330	11.0 × 18.5 × 18.0	B32652A6334+***	–	2200	1200
		390	11.0 × 18.5 × 18.0	B32652A6394+***	–	2200	1200

MOQ = Minimum Order Quantity, consisting of 4 packing units.
Further E series and intermediate capacitance values on request.

Composition of ordering code

+ = Capacitance tolerance code:

K = ±10%

J = ±5%

*** = Packaging code:

289 = Straight terminals, Ammo pack

189 = Straight terminals, Reel

000 = Straight terminals, Untaped (standard lead length 6 – 1 mm)

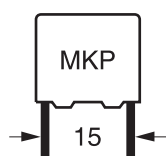
B32652
High pulse (wound)
Ordering codes and packing units (lead spacing 15 mm)

V_R	V_{RMS} $f \leq 1$ kHz	C_R	Max. dimensions $w \times h \times l$	Ordering code (composition see below)	Straight terminals, Ammo pack pcs./MOQ	Straight terminals, Reel pcs./ MOQ	Straight terminals, Untaped pcs./ MOQ
V DC	V AC	nF	mm				
1000	250	10	5.0 × 10.5 × 18.0	B32652A0103+***	4680	5200	4000
		15	5.0 × 10.5 × 18.0	B32652A0153+***	4680	5200	4000
		22	5.0 × 10.5 × 18.0	B32652A0223+***	4680	5200	4000
		33	6.0 × 11.0 × 18.0	B32652A0333+***	3840	4400	4000
		47	7.0 × 12.5 × 18.0	B32652A0473+***	3320	3600	4000
		68	8.5 × 14.5 × 18.0	B32652A0683+***	2720	2800	2000
		100	9.0 × 17.5 × 18.0	B32652A0104+***	2560	2800	2000
		120	11.0 × 18.5 × 18.0	B32652A0124+***	—	2200	1200
		150	11.0 × 18.5 × 18.0	B32652A0154+***	—	2200	1200
1250	500	6.8	5.0 × 10.5 × 18.0	B32652A7682+***	4680	5200	4000
		10	6.0 × 11.0 × 18.0	B32652A7103+***	3840	4400	4000
		15	7.0 × 12.5 × 18.0	B32652A7153+***	3320	3600	4000
		22	8.5 × 14.5 × 18.0	B32652A7223+***	2720	2800	2000
		33	9.0 × 17.5 × 18.0	B32652A7333+***	2560	2800	2000
		47	11.0 × 18.5 × 18.0	B32652A7473+***	—	2200	1200
		56	11.0 × 18.5 × 18.0	B32652A7563+***	—	2200	1200
1600	500	3.3	5.0 × 10.5 × 18.0	B32652A1332+***	4680	5200	4000
		4.7	6.0 × 11.0 × 18.0	B32652A1472+***	3840	4400	4000
		6.8	7.0 × 12.5 × 18.0	B32652A1682+***	3320	3600	4000
		10	8.5 × 14.5 × 18.0	B32652A1103+***	2720	2800	2000
		15	9.0 × 17.5 × 18.0	B32652A1153+***	2560	2800	2000
		22	11.0 × 18.5 × 18.0	B32652A1223+***	—	2200	1200
1600	700	2.2	5.0 × 10.5 × 18.0	B32652J1222+***	4680	5200	4000
		3.3	6.0 × 11.0 × 18.0	B32652J1332+***	3840	4400	4000
		4.7	7.0 × 12.5 × 18.0	B32652J1472+***	3320	3600	4000
		6.8	8.5 × 14.5 × 18.0	B32652J1682+***	2720	2800	2000
		10	9.0 × 17.5 × 18.0	B32652J1103+***	2560	2800	2000
		12	9.0 × 17.5 × 18.0	B32652J1123+***	2560	2800	2000
		15	11.0 × 18.5 × 18.0	B32652J1153+***	—	2200	1200

MOQ = Minimum Order Quantity, consisting of 4 packing units.
Further E series and intermediate capacitance values on request.

Composition of ordering code

+ = Capacitance tolerance code:

K = ±10%

J = ±5%

*** = Packaging code:

289 = Straight terminals, Ammo pack

189 = Straight terminals, Reel

000 = Straight terminals, Untaped (standard lead length 6 – 1 mm)

B32652

High pulse (wound)



Ordering codes and packing units (lead spacing 15 mm)

V_R	V_{RMS} $f \leq 1$ kHz	C_R	Max. dimensions $w \times h \times l$	Ordering code (composition see below)	Straight terminals, Ammo pack pcs./MOQ	Straight terminals, Reel pcs./ MOQ	Straight terminals, Untaped pcs./ MOQ
V DC	V AC	nF	mm				
2000	700	1.0	5.0 × 10.5 × 18.0	B32652A2102+***	4680	5200	4000
		1.5	6.0 × 11.0 × 18.0	B32652A2152+***	3840	4400	4000
		2.2	7.0 × 12.5 × 18.0	B32652A2222+***	3320	3600	4000
		3.3	8.5 × 14.5 × 18.0	B32652A2332+***	2720	2800	2000
		4.7	9.0 × 17.5 × 18.0	B32652A2472+***	2560	2800	2000
		5.6	9.0 × 17.5 × 18.0	B32652A2562+***	–	2200	1000
		6.8	11.0 × 18.5 × 18.0	B32652A2682+***	–	2200	1200

MOQ = Minimum Order Quantity, consisting of 4 packing units.
Further E series and intermediate capacitance values on request.

Composition of ordering code

+ = Capacitance tolerance code:

K = ±10%

J = ±5%

*** = Packaging code:

289 = Straight terminals, Ammo pack

189 = Straight terminals, Reel

000 = Straight terminals, Untaped (standard lead length 6 – 1 mm)

B32653
High pulse (wound)
Ordering codes and packing units (lead spacing 22.5 mm)

V_R	V_{RMS} $f \leq 1$ kHz	C_R	Max. dimensions $w \times h \times l$	Ordering code (composition see below)	Straight terminals, Ammo pack pcs./MOQ	Straight terminals, Reel pcs./ MOQ	Straight terminals, Untaped pcs./ MOQ
V DC	V AC	nF	mm				
250	160	220	6.0 × 15.0 × 26.5	B32653A3224+***	2720	2800	2880
		330	6.0 × 15.0 × 26.5	B32653A3334+***	2720	2800	2880
		470	7.0 × 16.0 × 26.5	B32653A3474+***	2320	2400	2520
		680	8.5 × 16.5 × 26.5	B32653A3684+***	1920	2000	2040
		1000	10.5 × 16.5 × 26.5	B32653A3105+***	1560	1600	2160
		1200	10.5 × 18.5 × 26.5	B32653A3125+***	1560	1600	2160
		1500	11.0 × 20.5 × 26.5	B32653A3155+***	1480	1400	2040
		2200	14.5 × 29.5 × 26.5	B32653A3225+000	—	—	1040
		3300	14.5 × 29.5 × 26.5	B32653A3335+000	—	—	1040
400	200	150	6.0 × 15.0 × 26.5	B32653A4154+***	2720	2800	2880
		220	6.0 × 15.0 × 26.5	B32653A4224+***	2720	2800	2880
		330	7.0 × 16.0 × 26.5	B32653A4334+***	2320	2400	2520
		470	8.5 × 16.5 × 26.5	B32653A4474+***	1920	2000	2040
		680	10.5 × 16.5 × 26.5	B32653A4684+***	1560	1600	2160
		1000	11.0 × 20.5 × 26.5	B32653A4105+***	1480	1400	2040
		1200	12.0 × 22.0 × 26.5	B32653A4125+000	—	—	1800
		1500	14.5 × 29.5 × 26.5	B32653A4155+000	—	—	1040
		2200	14.5 × 29.5 × 26.5	B32653A4225+000	—	—	1040
630	250	100	6.0 × 15.0 × 26.5	B32653A6104+***	2720	2800	2880
		150	6.0 × 15.0 × 26.5	B32653A6154+***	2720	2800	2880
		220	8.5 × 16.5 × 26.5	B32653A6224+***	1920	2000	2040
		330	10.5 × 16.5 × 26.5	B32653A6334+***	1560	1600	2160
		470	11.0 × 20.5 × 26.5	B32653A6474+***	1480	1400	2040
		560	11.0 × 20.5 × 26.5	B32653A6564+***	1480	1400	2040
		680	14.5 × 29.5 × 26.5	B32653A6684+000	—	—	1040
		1000	14.5 × 29.5 × 26.5	B32653A6105+000	—	—	1040
		1200	14.5 × 29.5 × 26.5	B32653A6125+000	—	—	1040

MOQ = Minimum Order Quantity, consisting of 4 packing units.
Further E series and intermediate capacitance values on request.

Composition of ordering code

+ = Capacitance tolerance code:

K = ±10%

J = ±5%

*** = Packaging code:

289 = Straight terminals, Ammo pack

189 = Straight terminals, Reel

000 = Straight terminals, Untaped (standard lead length 6 – 1 mm)

Ordering codes and packing units (lead spacing 22.5 mm)

V_R	V_{RMS} $f \leq 1$ kHz	C_R	Max. dimensions $w \times h \times l$	Ordering code (composition see below)	Straight terminals, Ammo pack pcs./MOQ	Straight terminals, Reel pcs./ MOQ	Straight terminals, Untaped pcs./ MOQ
V DC	V AC	nF	mm				
1000	250	33	6.0 × 15.0 × 26.5	B32653A0333+***	2720	2800	2880
		47	6.0 × 15.0 × 26.5	B32653A0473+***	2720	2800	2880
		68	6.0 × 15.0 × 26.5	B32653A0683+***	2720	2800	2880
		100	8.5 × 16.5 × 26.5	B32653A0104+***	1920	2000	2040
		150	10.5 × 16.5 × 26.5	B32653A0154+***	1560	1600	2160
		220	11.0 × 20.5 × 26.5	B32653A0224+***	1480	1400	2040
		330	14.5 × 29.5 × 26.5	B32653A0334+000	—	—	2160
		470	14.5 × 29.5 × 26.5	B32653A0474+000	—	—	2160
		560	14.5 × 29.5 × 26.5	B32653A0564+000	—	—	2160
1250	500	22	6.0 × 15.0 × 26.5	B32653A7223+***	2720	2800	2880
		33	6.0 × 15.0 × 26.5	B32653A7333+***	2720	2800	2880
		47	8.5 × 16.5 × 26.5	B32653A7473+***	1920	2000	2040
		68	10.5 × 16.5 × 26.5	B32653A7683+***	1560	1600	2160
		100	11.0 × 20.5 × 26.5	B32653A7104+***	1480	1400	2040
		120	12.0 × 22.0 × 26.5	B32653A7124+000	—	—	1800
		150	14.5 × 29.5 × 26.5	B32653A7154+000	—	—	1040
				220	14.5 × 29.5 × 26.5	B32653A7224+000	—
1600	500	6.8	6.0 × 15.0 × 26.5	B32653A1682+***	2720	2800	2880
		10	6.0 × 15.0 × 26.5	B32653A1103+***	2720	2800	2880
		15	7.0 × 16.0 × 26.5	B32653A1153+***	2320	2400	2520
		22	8.5 × 16.5 × 26.5	B32653A1223+***	1920	2000	2040
		33	10.5 × 16.5 × 26.5	B32653A1333+***	1560	1600	2160
		47	11.0 × 20.5 × 26.5	B32653A1473+***	1480	1400	2040
		56	12.0 × 22.0 × 26.5	B32653A1563+000	—	—	1800
		68	14.5 × 29.5 × 26.5	B32653A1683+000	—	—	1040
		82	14.5 × 29.5 × 26.5	B32653A1823+000	—	—	1040
				100	14.5 × 29.5 × 26.5	B32653A1104+000	—

MOQ = Minimum Order Quantity, consisting of 4 packing units.
Further E series and intermediate capacitance values on request.

Composition of ordering code

+ = Capacitance tolerance code:

K = ±10%

J = ±5%

*** = Packaging code:

289 = Straight terminals, Ammo pack

189 = Straight terminals, Reel

000 = Straight terminals, Untaped (standard lead length 6 – 1 mm)

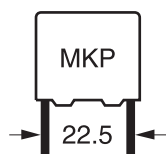
B32653
High pulse (wound)
Ordering codes and packing units (lead spacing 22.5 mm)

V_R	V_{RMS} $f \leq 1$ kHz	C_R	Max. dimensions $w \times h \times l$	Ordering code (composition see below)	Straight terminals, Ammo pack pcs./MOQ	Straight terminals, Reel pcs./ MOQ	Straight terminals, Untaped pcs./ MOQ
V DC	V AC	nF	mm				
2000	700	3.3	6.0 × 15.0 × 26.5	B32653A2332+***	2720	2800	2880
		4.7	6.0 × 15.0 × 26.5	B32653A2472+***	2720	2800	2880
		6.8	8.5 × 16.5 × 26.5	B32653A2682+***	1920	2000	2040
		10	10.5 × 16.5 × 26.5	B32653A2103+***	1560	1600	2160
		15	11.0 × 20.5 × 26.5	B32653A2153+***	1480	1400	2040
		22	14.5 × 29.5 × 26.5	B32653A2223+000	–	–	2160
		33	14.5 × 29.5 × 26.5	B32653A2333+000	–	–	2160
2000	1000	2.2	6.0 × 15.0 × 26.5	B32653A8222+***	2720	2800	2880
		3.3	6.0 × 15.0 × 26.5	B32653A8332+***	2720	2800	2880
		4.7	8.5 × 16.5 × 26.5	B32653A8472+***	1920	2000	2040
		6.8	10.5 × 16.5 × 26.5	B32653A8682+***	1560	1600	2160
		10	10.5 × 20.5 × 26.5	B32653A8103+***	1560	1600	2160
		12	12.0 × 22.0 × 26.5	B32653A8123+000	–	–	1800
		15	14.5 × 29.5 × 26.5	B32653A8153+000	–	–	2160
		22	14.5 × 29.5 × 26.5	B32653A8223+000	–	–	2160

MOQ = Minimum Order Quantity, consisting of 4 packing units.

Further E series and intermediate capacitance values on request.

Composition of ordering code

+ = Capacitance tolerance code:

K = ±10%

J = ±5%

*** = Packaging code:

289 = Straight terminals, Ammo pack

189 = Straight terminals, Reel

000 = Straight terminals, Untaped (standard lead length 6 – 1 mm)

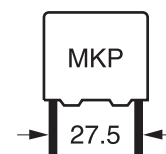
Ordering codes and packing units (lead spacing 27.5 mm)

V_R	V_{RMS} $f \leq 1 \text{ kHz}$	C_R	Max. dimensions $w \times h \times l$	Ordering code (composition see below)	Straight terminals, Ammo pack pcs./MOQ	Straight terminals, Reel pcs./MOQ	Straight terminals, Untaped pcs./MOQ
V DC	V AC	nF	mm				
250	160	1500	11.0 × 21.0 × 31.5	B32654A3155+***	—	1400	1280
		2200	12.5 × 21.5 × 31.5	B32654A3225+***	—	1200	1120
		3300	15.0 × 24.5 × 31.5	B32654A3335+000	—	—	960
		4700	18.0 × 27.5 × 31.5	B32654A3475+000	—	—	800
		5600	19.0 × 30.0 × 31.5	B32654A3565+000	—	—	720
		6800	22.0 × 36.5 × 31.5	B32654A3685+000	—	—	640
		8200	22.0 × 36.5 × 31.5	B32654A3825+000	—	—	640
400	200	1000	11.0 × 21.0 × 31.5	B32654A4105+***	—	1400	1280
		1500	12.5 × 21.5 × 31.5	B32654A4155+***	—	1200	1120
		2200	14.0 × 24.5 × 31.5	B32654A4225+***	—	1000	1040
		3300	19.0 × 30.0 × 31.5	B32654A4335+000	—	—	720
		4700	22.0 × 36.5 × 31.5	B32654A4475+000	—	—	640
		5600	22.0 × 36.5 × 31.5	B32654A4565+000	—	—	640
630	250	680	11.0 × 21.0 × 31.5	B32654A6684+***	—	1400	1280
		1000	13.5 × 23.0 × 31.5	B32654A6105+***	—	1000	1040
		1500	18.0 × 27.5 × 31.5	B32654A6155+000	—	—	800
		2200	18.0 × 33.0 × 31.5	B32654A6225+000	—	—	800
		2700	22.0 × 36.5 × 31.5	B32654A6275+000	—	—	640
		3300	22.0 × 36.5 × 31.5	B32654A6335K000	—	—	640
1000	250	220	11.0 × 21.0 × 31.5	B32654A0224+***	—	1400	1280
		330	11.0 × 21.0 × 31.5	B32654A0334+***	—	1400	1280
		470	14.0 × 24.5 × 31.5	B32654A0474+***	—	1000	1040
		680	18.0 × 27.5 × 31.5	B32654A0684+000	—	—	800
		820	19.0 × 30.0 × 31.5	B32654A0824+000	—	—	720
		1000	21.0 × 31.0 × 31.5	B32654A0105+000	—	—	720
		1200	22.0 × 36.5 × 31.5	B32654A0125+000	—	—	640
		1500	22.0 × 36.5 × 31.5	B32654A0155K000	—	—	640

MOQ = Minimum Order Quantity, consisting of 4 packing units.
Further E series and intermediate capacitance values on request.

Composition of ordering code

+ = Capacitance tolerance code:

K = ±10%

J = ±5%

*** = Packaging code:

189 = Straight terminals, Reel

000 = Straight terminals, Untaped (standard lead length 6 – 1 mm)

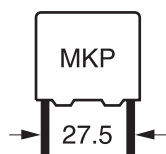

B32654

High pulse (wound)

Ordering codes and packing units (lead spacing 27.5 mm)

V_R	V_{RMS} $f \leq 1$ kHz	C_R	Max. dimensions $w \times h \times l$	Ordering code (composition see below)	Straight terminals, Ammo pack pcs./MOQ	Straight terminals, Reel pcs./MOQ	Straight terminals, Untaped pcs./MOQ
V DC	V AC	nF	mm				
1250	500	100	11.0 × 21.0 × 31.5	B32654A7104+***	—	1400	1280
		150	11.0 × 21.0 × 31.5	B32654A7154+***	—	1400	1280
		220	14.0 × 24.5 × 31.5	B32654A7224+***	—	1000	1040
		330	18.0 × 27.5 × 31.5	B32654A7334+000	—	—	800
		470	21.0 × 31.0 × 31.5	B32654A7474+000	—	—	720
		560	22.0 × 36.5 × 31.5	B32654A7564+000	—	—	640
1600	500	680	22.0 × 36.5 × 31.5	B32654A7684+000	—	—	640
		47	11.0 × 21.0 × 31.5	B32654A1473+***	—	1400	1280
		68	11.0 × 21.0 × 31.5	B32654A1683+***	—	1400	1280
		100	14.0 × 24.5 × 31.5	B32654A1104+***	—	1000	1040
		150	18.0 × 27.5 × 31.5	B32654A1154+000	—	—	800
		220	21.0 × 31.0 × 31.5	B32654A1224+000	—	—	784
2000	700	22	11.0 × 21.0 × 31.5	B32654A2223+***	—	1400	1280
		33	13.5 × 23.0 × 31.5	B32654A2333+***	—	1000	1040
		47	18.0 × 27.5 × 31.5	B32654A2473+000	—	—	800
		68	19.0 × 30.0 × 31.5	B32654A2683+000	—	—	720
		82	22.0 × 36.5 × 31.5	B32654A2823+000	—	—	640
		100	22.0 × 36.5 × 31.5	B32654A2104+000	—	—	640

MOQ = Minimum Order Quantity, consisting of 4 packing units.
Further E series and intermediate capacitance values on request.

Composition of ordering code

+ = Capacitance tolerance code:

K = ±10%

J = ±5%

*** = Packaging code:

189 = Straight terminals, Reel

000 = Straight terminals, Untaped (standard lead length 6 – 1 mm)

Ordering codes and packing units (lead spacing 37.5 mm)

V_R	V_{RMS} $f \leq 1$ kHz	C_R	Max. dimensions $w \times h \times l$	P_1	Ordering code (composition see below)	Straight terminals, Untaped pcs./MOQ
V DC	V AC	nF	mm	mm		
250	160	2700	12.0 × 22.0 × 42.0	—	B32656A3275+000	1620
		3000	12.0 × 22.0 × 42.0	—	B32656A3305+000	1620
		3300	14.0 × 25.0 × 42.0	—	B32656A3335+000	1380
		4000	14.0 × 25.0 × 42.0	—	B32656A3405+000	1380
		4000	24.0 × 15.0 × 42.0	—	B32656T3405+000	1040
		4700	16.0 × 28.5 × 42.0	—	B32656A3475+000	800
		5600	16.0 × 28.5 × 42.0	—	B32656A3565+000	800
		5600	24.0 × 19.0 × 42.0	—	B32656T3565+000	780
		6800	18.0 × 32.5 × 42.0	—	B32656A3685+000	720
		8000	18.0 × 32.5 × 42.0	—	B32656A3805+000	720
		10000	20.0 × 39.5 × 42.0	10.2	B32656G3106+000	640
		10000	20.0 × 39.5 × 42.0	—	B32656A3106+000	640
		12000	20.0 × 39.5 × 42.0	10.2	B32656G3126K000	640
		12000	20.0 × 39.5 × 42.0	—	B32656A3126K000	640
		15000	28.0 × 37.0 × 42.0	10.2	B32656G3156K000	440
		15000	28.0 × 37.0 × 42.0	—	B32656A3156K000	440
		17000	28.0 × 42.5 × 42.0	10.2	B32656G3176+000	440
		17000	28.0 × 42.5 × 42.0	—	B32656A3176+000	440
		20000	30.0 × 45.0 × 42.0	20.3	B32656G3206+000	400
		20000	30.0 × 45.0 × 42.0	—	B32656A3206+000	400
24000	33.0 × 48.0 × 42.0	20.3	B32656G3246+000	180		
24000	33.0 × 48.0 × 42.0	—	B32656A3246+000	180		

MOQ = Minimum Order Quantity, consisting of 4 packing units.

Further E series and intermediate capacitance values on request.

Composition of ordering code

+ = Capacitance tolerance code:

K = ±10%

J = ±5%

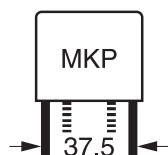
B32656
High pulse (wound)
Ordering codes and packing units (lead spacing 37.5 mm)

V_R	V_{RMS} $f \leq 1$ kHz	C_R	Max. dimensions $w \times h \times l$	P_1	Ordering code (composition see below)	Straight terminals, Untaped pcs./MOQ
V DC	V AC	nF	mm	mm		
400	200	2000	12.0 × 22.0 × 42.0	—	B32656A4205+000	1620
		2700	14.0 × 25.0 × 42.0	—	B32656A4275+000	1380
		2700	24.0 × 15.0 × 42.0	—	B32656T4275+000	1040
		3500	24.0 × 19.0 × 42.0	—	B32656T4355+000	780
		4000	16.0 × 28.5 × 42.0	—	B32656A4405+000	800
		5600	18.0 × 32.5 × 42.0	—	B32656A4565+000	720
		7500	20.0 × 39.5 × 42.0	10.2	B32656G4755+000	640
		7500	20.0 × 39.5 × 42.0	—	B32656A4755+000	640
		10000	28.0 × 37.0 × 42.0	10.2	B32656G4106+000	440
		10000	28.0 × 37.0 × 42.0	—	B32656A4106+000	440
		12000	28.0 × 42.5 × 42.0	10.2	B32656G4126+000	440
		12000	28.0 × 42.5 × 42.0	—	B32656A4126+000	440
		14000	30.0 × 45.0 × 42.0	20.3	B32656G4146+000	400
		14000	30.0 × 45.0 × 42.0	—	B32656A4146+000	400
		17000	33.0 × 48.0 × 42.0	20.3	B32656G4176+000	180
		17000	33.0 × 48.0 × 42.0	—	B32656A4176+000	180
630	250	1000	12.0 × 22.0 × 42.0	—	B32656A6105+000	1620
		1500	14.0 × 25.0 × 42.0	—	B32656A6155+000	1380
		1500	24.0 × 15.0 × 42.0	—	B32656T6155+000	1040
		2200	16.0 × 28.5 × 42.0	—	B32656A6225+000	800
		2200	24.0 × 19.0 × 42.0	—	B32656T6225+000	780
		3000	18.0 × 32.5 × 42.0	—	B32656A6305+000	720
		4000	20.0 × 39.5 × 42.0	10.2	B32656G6405+000	640
		4000	20.0 × 39.5 × 42.0	—	B32656A6405+000	640
		5600	28.0 × 37.0 × 42.0	10.2	B32656G6565+000	440
		5600	28.0 × 37.0 × 42.0	—	B32656A6565+000	440
		7000	28.0 × 42.5 × 42.0	10.2	B32656G6705K000	440
		7000	28.0 × 42.5 × 42.0	—	B32656A6705K000	440
		8000	30.0 × 45.0 × 42.0	20.3	B32656G6805+000	400
		8000	30.0 × 45.0 × 42.0	—	B32656A6805+000	400
		10000	33.0 × 48.0 × 42.0	20.3	B32656G6106K000	180
		10000	33.0 × 48.0 × 42.0	—	B32656A6106K000	180

MOQ = Minimum Order Quantity, consisting of 4 packing units.
Further E series and intermediate capacitance values on request.

Composition of ordering code

+ = Capacitance tolerance code:

K = ±10%

J = ±5%

Ordering codes and packing units (lead spacing 37.5 mm)

V_R	V_{RMS} $f \leq 1$ kHz	C_R	Max. dimensions $w \times h \times l$ mm	P_1 mm	Ordering code (composition see below)	Straight terminals, Untaped pcs./MOQ
V DC	V AC	nF				
750	350	470	12.0 × 22.0 × 42.0	—	B32656A5474+000	1620
		560	12.0 × 22.0 × 42.0	—	B32656A5564+000	1620
		680	12.0 × 22.0 × 42.0	—	B32656A5684+000	1620
		820	14.0 × 25.0 × 42.0	—	B32656A5824+000	1380
		1000	16.0 × 28.5 × 42.0	—	B32656A5105+000	800
		1000	24.0 × 15.0 × 42.0	—	B32656T5105K000	1040
		1200	16.0 × 28.5 × 42.0	—	B32656A5125+000	800
		1200	24.0 × 19.0 × 42.0	—	B32656T5125+000	780
		1500	18.0 × 32.5 × 42.0	—	B32656A5155+000	720
		1800	18.0 × 32.5 × 42.0	—	B32656A5185+000	720
		2200	20.0 × 39.5 × 42.0	10.2	B32656G5225+000	640
		2200	20.0 × 39.5 × 42.0	—	B32656A5225+000	640
		2500	20.0 × 39.5 × 42.0	10.2	B32656G5255+000	640
		2500	20.0 × 39.5 × 42.0	—	B32656A5255+000	640
		2700	28.0 × 37.0 × 42.0	10.2	B32656G5275+000	440
		2700	28.0 × 37.0 × 42.0	—	B32656A5275+000	440
		3300	28.0 × 37.0 × 42.0	10.2	B32656G5335+000	440
		3300	28.0 × 37.0 × 42.0	—	B32656A5335+000	440
		4000	28.0 × 42.5 × 42.0	10.2	B32656G5405+000	440
		4000	28.0 × 42.5 × 42.0	—	B32656A5405+000	440
		4700	30.0 × 45.0 × 42.0	20.3	B32656G5475+000	400
		4700	30.0 × 45.0 × 42.0	—	B32656A5475+000	400
		5600	33.0 × 48.0 × 42.0	20.3	B32656G5565+000	180
5600	33.0 × 48.0 × 42.0	—	B32656A5565+000	180		

MOQ = Minimum Order Quantity, consisting of 4 packing units.
Further E series and intermediate capacitance values on request.

Composition of ordering code

+ = Capacitance tolerance code:

K = ±10%

J = ±5%

B32656
High pulse (wound)
Ordering codes and packing units (lead spacing 37.5 mm)

V_R	V_{RMS} $f \leq 1$ kHz	C_R	Max. dimensions $w \times h \times l$ mm	P_1 mm	Ordering code (composition see below)	Straight terminals, Untaped pcs./MOQ
V DC	V AC	nF				
850	450	220	12.0 × 22.0 × 42.0	—	B32656A8224+000	1620
		330	12.0 × 22.0 × 42.0	—	B32656A8334+000	1620
		470	12.0 × 22.0 × 42.0	—	B32656A8474+000	1620
		680	16.0 × 28.5 × 42.0	—	B32656A8684+000	800
		680	24.0 × 15.0 × 42.0	—	B32656T8684+000	1040
		820	24.0 × 19.0 × 42.0	—	B32656T8824+000	780
		1000	18.0 × 32.5 × 42.0	—	B32656A8105+000	720
		1200	18.0 × 32.5 × 42.0	—	B32656A8125+000	720
		1500	20.0 × 39.5 × 42.0	10.2	B32656G8155+000	640
		1500	20.0 × 39.5 × 42.0	—	B32656A8155+000	640
		1800	20.0 × 39.5 × 42.0	10.2	B32656G8185+000	640
		1800	20.0 × 39.5 × 42.0	—	B32656A8185+000	640
		2200	28.0 × 37.0 × 42.0	10.2	B32656G8225+000	440
		2200	28.0 × 37.0 × 42.0	—	B32656A8225+000	440
		2500	28.0 × 42.5 × 42.0	10.2	B32656G8255+000	440
		2500	28.0 × 42.5 × 42.0	—	B32656A8255+000	440
		2700	30.0 × 45.0 × 42.0	20.3	B32656G8275+000	400
		2700	30.0 × 45.0 × 42.0	—	B32656A8275+000	400
		3000	30.0 × 45.0 × 42.0	20.3	B32656G8305+000	400
		3000	30.0 × 45.0 × 42.0	—	B32656A8305+000	400
3300	33.0 × 48.0 × 42.0	20.3	B32656G8335+000	180		
3300	33.0 × 48.0 × 42.0	—	B32656A8335+000	180		
3800	33.0 × 48.0 × 42.0	20.3	B32656G8385+000	180		
3800	33.0 × 48.0 × 42.0	—	B32656A8385+000	180		

MOQ = Minimum Order Quantity, consisting of 4 packing units.
Further E series and intermediate capacitance values on request.

Composition of ordering code

+ = Capacitance tolerance code:

K = ±10%

J = ±5%

Ordering codes and packing units (lead spacing 37.5 mm)

V_R	V_{RMS} $f \leq 1$ kHz	C_R	Max. dimensions $w \times h \times l$ mm	P_1 mm	Ordering code (composition see below)	Straight terminals, Untaped pcs./MOQ
V DC	V AC	nF				
1000	500	330	12.0 × 22.0 × 42.0	—	B32656A0334+000	1620
		470	14.0 × 25.0 × 42.0	—	B32656A0474+000	1380
		470	24.0 × 15.0 × 42.0	—	B32656T0474+000	1040
		680	16.0 × 28.5 × 42.0	—	B32656A0684+000	800
		680	24.0 × 19.0 × 42.0	—	B32656T0684+000	780
		1000	20.0 × 39.5 × 42.0	10.2	B32656G0105+000	640
		1000	20.0 × 39.5 × 42.0	—	B32656A0105+000	640
		1200	28.0 × 37.0 × 42.0	10.2	B32656G0125+000	440
		1200	28.0 × 37.0 × 42.0	—	B32656A0125+000	440
		1500	28.0 × 37.0 × 42.0	10.2	B32656G0155+000	440
		1500	28.0 × 37.0 × 42.0	—	B32656A0155+000	440
		2200	30.0 × 45.0 × 42.0	20.3	B32656G0225+000	400
		2200	30.0 × 45.0 × 42.0	—	B32656A0225+000	400
		2700	30.0 × 45.0 × 42.0	20.3	B32656G0275M000	400
		2700	30.0 × 45.0 × 42.0	—	B32656A0275M000	400
		2700	33.0 × 48.0 × 42.0	20.3	B32656G0275+000	180
2700	33.0 × 48.0 × 42.0	—	B32656A0275+000	180		

MOQ = Minimum Order Quantity, consisting of 4 packing units.
Further E series and intermediate capacitance values on request.

Composition of ordering code

+ = Capacitance tolerance code:

K = ±10%

J = ±5%

B32656
High pulse (wound)
Ordering codes and packing units (lead spacing 37.5 mm)

V_R	V_{RMS} $f \leq 1$ kHz	C_R	Max. dimensions $w \times h \times l$	P_1	Ordering code (composition see below)	Straight terminals, Untaped pcs./MOQ
V DC	V AC	nF	mm	mm		
1250	500	150	12.0 × 22.0 × 42.0	—	B32656A7154+000	1620
		220	14.0 × 25.0 × 42.0	—	B32656A7224+000	1380
		270	24.0 × 15.0 × 42.0	—	B32656T7274+000	1040
		330	16.0 × 28.5 × 42.0	—	B32656A7334+000	800
		390	24.0 × 19.0 × 42.0	—	B32656T7394+000	780
		470	18.0 × 32.5 × 42.0	—	B32656A7474+000	720
		680	20.0 × 39.5 × 42.0	10.2	B32656G7684+000	640
		680	20.0 × 39.5 × 42.0	—	B32656A7684+000	640
		820	28.0 × 37.0 × 42.0	10.2	B32656G7824+000	440
		820	28.0 × 37.0 × 42.0	—	B32656A7824+000	440
		1000	28.0 × 37.0 × 42.0	10.2	B32656G7105+000	440
		1000	28.0 × 37.0 × 42.0	—	B32656A7105+000	440
		1200	28.0 × 42.5 × 42.0	10.2	B32656G7125+000	440
		1200	28.0 × 42.5 × 42.0	—	B32656A7125+000	440
		1500	30.0 × 45.0 × 42.0	20.3	B32656G7155+000	400
		1500	30.0 × 45.0 × 42.0	—	B32656A7155+000	400
		1800	33.0 × 48.0 × 42.0	20.3	B32656G7185K000	180
1800	33.0 × 48.0 × 42.0	—	B32656A7185K000	180		

MOQ = Minimum Order Quantity, consisting of 4 packing units.

Further E series and intermediate capacitance values on request.

Composition of ordering code

+ = Capacitance tolerance code:

K = ±10%

J = ±5%

Ordering codes and packing units (lead spacing 37.5 mm)

V_R	V_{RMS} $f \leq 1$ kHz	C_R	Max. dimensions $w \times h \times l$ mm	P_1 mm	Ordering code (composition see below)	Straight terminals, Untaped pcs./MOQ
V DC	V AC	nF				
1600	600	100	12.0 × 22.0 × 42.0	—	B32656J1104+000	1620
		150	14.0 × 25.0 × 42.0	—	B32656J1154+000	1380
		150	24.0 × 15.0 × 42.0	—	B32656T1154+000	1040
		220	16.0 × 28.5 × 42.0	—	B32656J1224+000	800
		220	24.0 × 19.0 × 42.0	—	B32656T1224+000	780
		330	20.0 × 39.5 × 42.0	10.2	B32656G1334+000	640
		330	20.0 × 39.5 × 42.0	—	B32656J1334+000	640
		470	28.0 × 37.0 × 42.0	10.2	B32656G1474+000	440
		470	28.0 × 37.0 × 42.0	—	B32656J1474+000	440
		560	28.0 × 37.0 × 42.0	10.2	B32656G1564+000	440
		560	28.0 × 37.0 × 42.0	—	B32656J1564+000	440
		680	28.0 × 42.5 × 42.0	10.2	B32656G1684+000	440
		680	28.0 × 42.5 × 42.0	—	B32656J1684+000	440
		820	30.0 × 45.0 × 42.0	20.3	B32656G1824+000	400
		820	30.0 × 45.0 × 42.0	—	B32656J1824+000	400
		900	33.0 × 48.0 × 42.0	20.3	B32656G1905+000	180
900	33.0 × 48.0 × 42.0	—	B32656J1905+000	180		
2000	700	68	12.0 × 22.0 × 42.0	—	B32656J2683+000	1620
		100	14.0 × 25.0 × 42.0	—	B32656J2104+000	1380
		100	24.0 × 15.0 × 42.0	—	B32656T2104+000	1040
		120	24.0 × 19.0 × 42.0	—	B32656T2124+000	780
		150	18.0 × 32.5 × 42.0	—	B32656J2154+000	720
		220	20.0 × 39.5 × 42.0	10.2	B32656G2224+000	640
		220	20.0 × 39.5 × 42.0	—	B32656J2224+000	640
		330	28.0 × 37.0 × 42.0	10.2	B32656G2334+000	440
		330	28.0 × 37.0 × 42.0	—	B32656J2334+000	440
		470	30.0 × 45.0 × 42.0	20.3	B32656G2474+000	400
		470	30.0 × 45.0 × 42.0	—	B32656J2474+000	400
		560	33.0 × 48.0 × 42.0	20.3	B32656G2564+000	180
		560	33.0 × 48.0 × 42.0	—	B32656J2564+000	180

MOQ = Minimum Order Quantity, consisting of 4 packing units.
Further E series and intermediate capacitance values on request.

Composition of ordering code

+ = Capacitance tolerance code:

K = ±10%

J = ±5%

B32658
High pulse (wound)
Ordering codes and packing units (lead spacing 52.5 mm)

V_R	V_{RMS} $f \leq 1$ kHz	C_R	Max. dimensions $w \times h \times l$ mm	P_1 mm	Ordering code (composition see below)	Straight terminals, Untaped pcs./MOQ
V DC	V AC	nF				
250	160	30000	30.0 × 45.0 × 57.5	20.3	B32658G3306+000	280
		40000	35.0 × 50.0 × 57.5	20.3	B32658G3406K000	108
400	200	20000	30.0 × 45.0 × 57.5	20.3	B32658G4206+000	280
		26000	35.0 × 50.0 × 57.5	20.3	B32658G4266+000	108
630	250	12000	30.0 × 45.0 × 57.5	20.3	B32658G6126K000	280
		15000	35.0 × 50.0 × 57.5	20.3	B32658G6156+000	108
750	350	6800	30.0 × 45.0 × 57.5	20.3	B32658G5685+000	280
		9000	35.0 × 50.0 × 57.5	20.3	B32658G5905+000	108
850	450	4700	30.0 × 45.0 × 57.5	20.3	B32658G8475+000	280
		5600	35.0 × 50.0 × 57.5	20.3	B32658G8565+000	108
		6000	35.0 × 50.0 × 57.5	20.3	B32658G8605+000	108
1000	500	3300	30.0 × 45.0 × 57.5	20.3	B32658G0335+000	280
		4500	35.0 × 50.0 × 57.5	20.3	B32658G0455+000	108
1250	500	2000	30.0 × 45.0 × 57.5	20.3	B32658G7205+000	280
		2200	35.0 × 50.0 × 57.5	20.3	B32658G7225+000	108
		2700	35.0 × 50.0 × 57.5	20.3	B32658G7275+000	108
1600	600	1000	30.0 × 45.0 × 57.5	20.3	B32658G1105+000	280
		1200	30.0 × 45.0 × 57.5	20.3	B32658G1125K000	280
		1500	35.0 × 50.0 × 57.5	20.3	B32658G1155+000	108
2000	700	680	30.0 × 45.0 × 57.5	20.3	B32658G2684+000	280
		820	35.0 × 50.0 × 57.5	20.3	B32658G2824+000	108
		1000	35.0 × 50.0 × 57.5	20.3	B32658G2105K000	108

MOQ = Minimum Order Quantity, consisting of 4 packing units.
Further E series and intermediate capacitance values on request.

Composition of ordering code

+ = Capacitance tolerance code:

K = ±10%

J = ±5%

Technical data

Operating temperature range	Max. operating temperature $T_{op,max}$		+110 °C		
	Upper category temperature T_{max}		+100 °C		
	Lower category temperature T_{min}		-55 °C		
	Rated temperature T_R		+85 °C		
Dissipation factor $\tan \delta$ (in 10^{-3}) at 20 °C (upper limit values)	at	≤ 27 nF	27 nF < $C_R \leq 0.1$ μ F	0.1 μ F < $C_R \leq 1$ μ F	$C_R > 1$ μ F
	1 kHz	0.8	0.8	0.8	0.8
	10 kHz	1.0	1.0	1.0	—
	100 kHz	2.0	3.0	—	—
Insulation resistance R_{ins} or time constant $\tau = C_R \cdot R_{ins}$ at 20 °C, rel. humidity $\leq 65\%$ (minimum as-delivered values)	$C_R \leq 0.33$ μ F		$C_R > 0.33$ μ F		
	100 G Ω		30000 s		
DC test voltage	$1.6 \cdot V_R$, 2 s				
Capacitance tolerance codes	J = $\pm 5\%$ K = $\pm 10\%$ M = $\pm 20\%$				
Category voltage V_C (continuous operation with V_{DC} or V_{AC} at $f \leq 1$ kHz)	T_{op} (°C)	DC voltage derating		AC voltage derating	
	$T_{op} \leq 85$	$V_C = V_R$		$V_{C,RMS} = V_{RMS}$	
	$85 < T_{op} \leq 100$	$V_C = V_R \cdot (165 - T_{op})/80$		$V_{C,RMS} = V_{RMS} \cdot (165 - T_{op})/80$	
Operating voltage V_{op} for short operating periods (V_{DC} or V_{AC} at $f \leq 1$ kHz)	T_{op} (°C)	DC voltage (max. hours)		AC voltage (max. hours)	
	$T_{op} \leq 85$	$V_{op} = 1.25 \cdot V_C$ (2000 h)		$V_{op} = 1.0 \cdot V_{C,RMS}$ (2000 h)	
	$85 < T_{op} \leq 100$	$V_{op} = 1.25 \cdot V_C$ (1000 h)		$V_{op} = 1.0 \cdot V_{C,RMS}$ (1000 h)	
Damp heat test	56 days/40 °C/93% relative humidity				
Limit values after damp heat test	Capacitance change $ \Delta C/C $		$\leq 3\%$		
	Dissipation factor change $\Delta \tan \delta$		$\leq 0.5 \cdot 10^{-3}$ (at 1 kHz)		
			$\leq 1.0 \cdot 10^{-3}$ (at 10 kHz)		
	Insulation resistance R_{ins} or time constant $\tau = C_R \cdot R_{ins}$		$\geq 50\%$ of minimum as-delivered values		
Reliability: Failure rate λ Service life t_{SL}	1 fit ($\leq 1 \cdot 10^{-9}/h$) at $0.5 \cdot V_R$, 40 °C 200 000 h at $1.0 \cdot V_R$, 85 °C For conversion to other operating conditions and temperatures, refer to chapter "Quality, 2 Reliability".				
Failure criteria: Total failure	Short circuit or open circuit				
Failure due to variation of parameters	Capacitance change $ \Delta C/C $		$> 10\%$		
	Dissipation factor $\tan \delta$		$> 4 \cdot$ upper limit value		
	Insulation resistance R_{ins}		< 1500 M Ω ($C_R \leq 0.33$ μ F)		
	or time constant $\tau = C_R \cdot R_{ins}$		< 500 s ($C_R > 0.33$ μ F)		



B32651 ... B32658

High pulse (wound)

Pulse handling capability

"dV/dt" represents the maximum permissible voltage change per unit of time for non-sinusoidal voltages, expressed in V/μs.

"k₀" represents the maximum permissible pulse characteristic of the waveform applied to the capacitor, expressed in V²/μs.

Note:

The values of dV/dt and k₀ provided below must not be exceeded in order to avoid damaging the capacitor.

dV/dt values

Lead spacing		10 mm	15 mm	22.5 mm	27.5 mm	37.5 mm	52.5 mm
V _R V DC	V _{RMS} V AC	dV/dt in V/μs					
250	160	—	200	120	50	36	24
400	200	—	300	180	100	55	36
630	250	—	400	300	150	80	50
750	350	—	—	—	—	250	160
850	450	—	—	—	—	340	220
1000	250	—	975	600	300	—	—
	500	—	—	—	—	400	265
1250	450	4000	—	—	—	—	—
	500	—	1850	1150	600	500	350
1600	500	—	4500	2400	1000	—	—
	600	—	—	—	—	600	400
	700	—	5200	—	—	—	—
2000	700	—	8000	7000	2300	700	475
	1000	—	—	7500	—	—	—

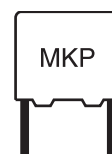

k₀ values

Lead spacing		10 mm	15 mm	22.5 mm	27.5 mm	37.5 mm	52.5 mm
V _R V DC	V _{RMS} V AC	k ₀ in V ² /μs					
250	160	—	100 000	60 000	25 000	18 000	12 000
400	200	—	250 000	200 000	110 000	44 000	28 800
630	250	—	500 000	350 000	250 000	100 800	63 000
750	350	—	—	—	—	375 000	240 000
850	450	—	—	—	—	578 000	374 000
1000	250	—	3 000 000	1 500 000	1 000 000	—	—
	500	—	—	—	—	800 000	530 000
1250	450	25 000 000	—	—	—	—	—
	500	—	9 000 000	3 750 000	2 000 000	1 250 000	875 000
1600	500	—	20 000 000	10 000 000	4 000 000	—	—
	600	—	—	—	—	1 920 000	1 280 000
	700	—	28 000 000	—	—	—	—
2000	700	—	60 000 000	40 000 000	15 000 000	2 800 000	1 900 000
	1000	—	—	50 000 000	—	—	—

Impedance Z versus frequency f
(typical values)

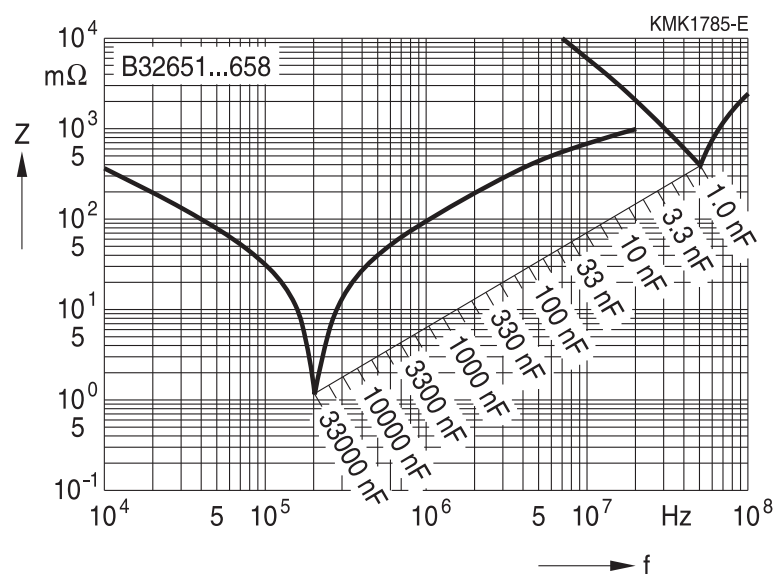



B32651

High pulse (wound)

Permissible AC voltage V_{RMS} versus frequency f (for sinusoidal waveforms, $T_A \leq 90\text{ °C}$)

For $T_A > 90\text{ °C}$, please refer to "General technical information", section 3.2.3.

Lead spacing 10 mm

1250 V DC/450 V AC

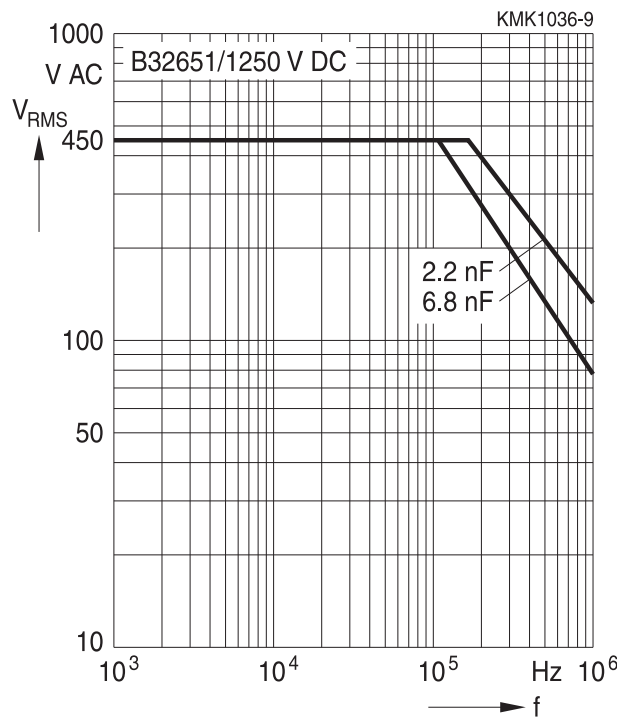

B32652

High pulse (wound)

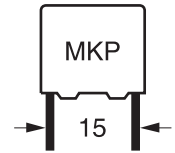

Permissible AC voltage V_{RMS} versus frequency f (for sinusoidal waveforms, $T_A \leq 90^\circ C$)

For $T_A > 90^\circ C$, please refer to "General technical information", section 3.2.3.

Lead spacing 15 mm

250 V DC/160 V AC

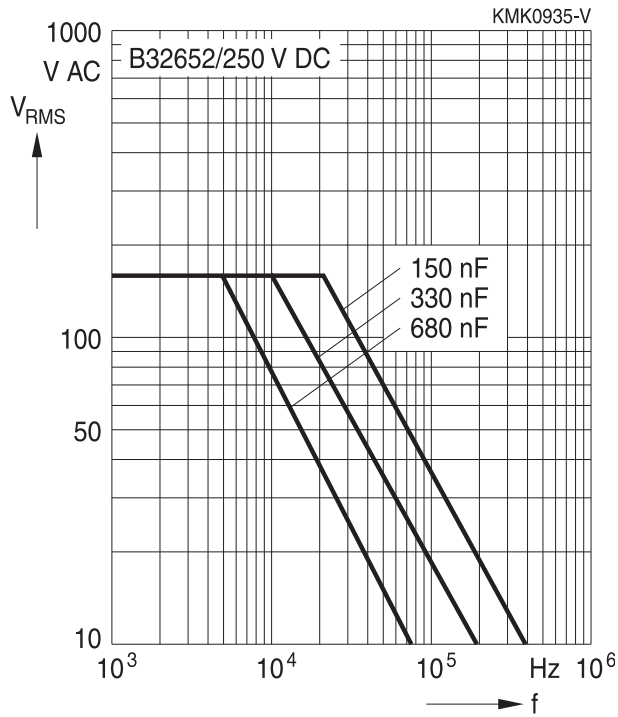

400 V DC/200 V AC

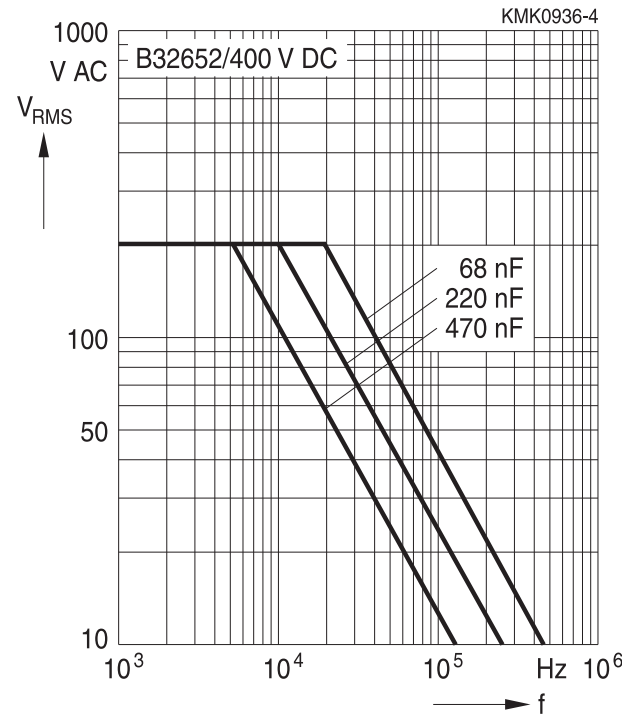

630 V DC/250 V AC

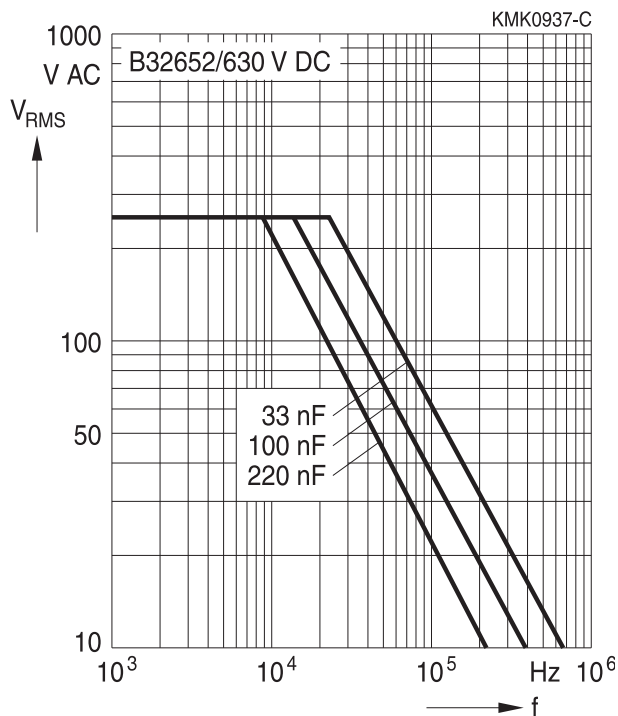

1000 V DC/250 V AC

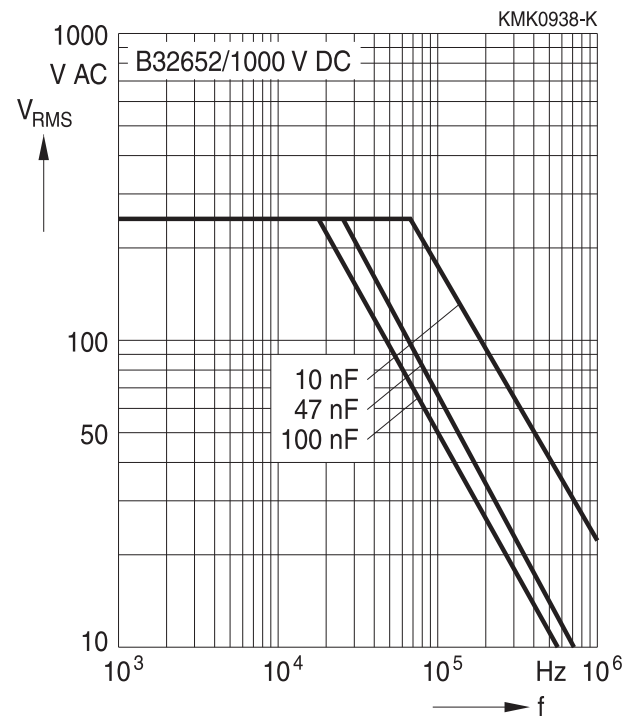



B32652

High pulse (wound)

Permissible AC voltage V_{RMS} versus frequency f (for sinusoidal waveforms, $T_A \leq 90^\circ C$)

For $T_A > 90^\circ C$, please refer to "General technical information", section 3.2.3.

Lead spacing 15 mm

1250 V DC/500 V AC

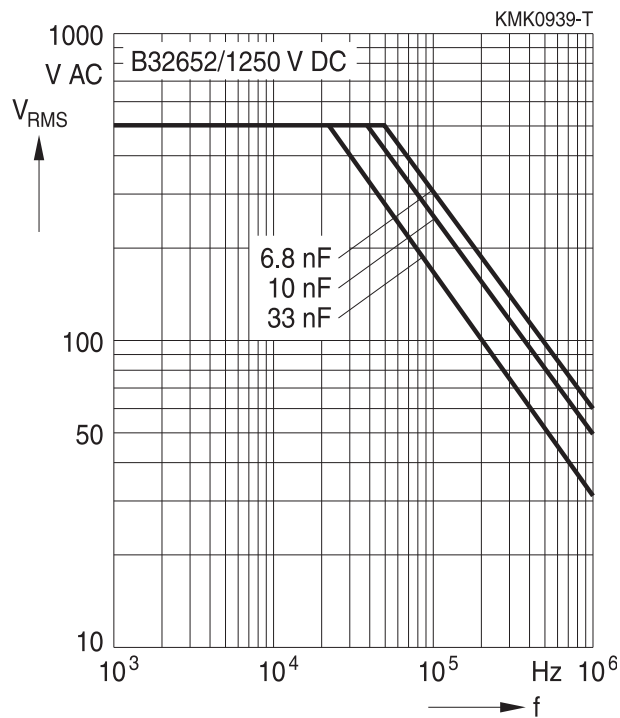

1600 V DC/500 V AC

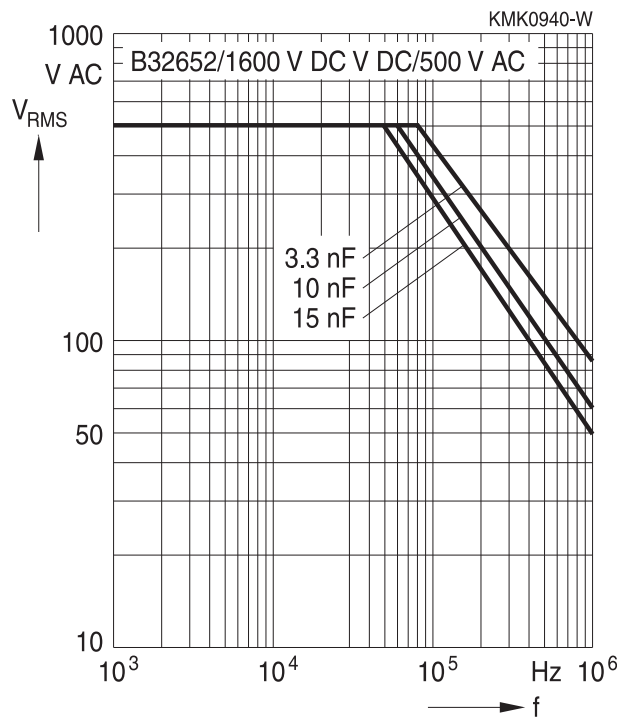

1600 V DC/700 V AC

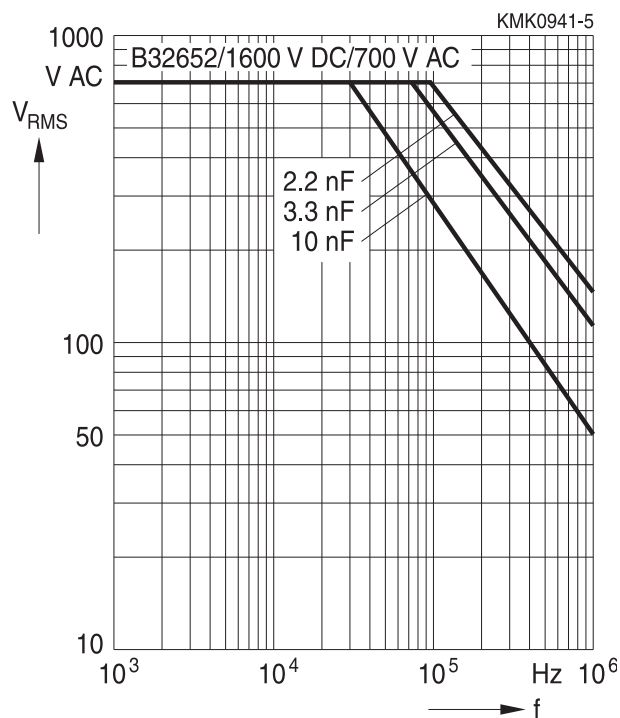

2000 V DC/700 V AC

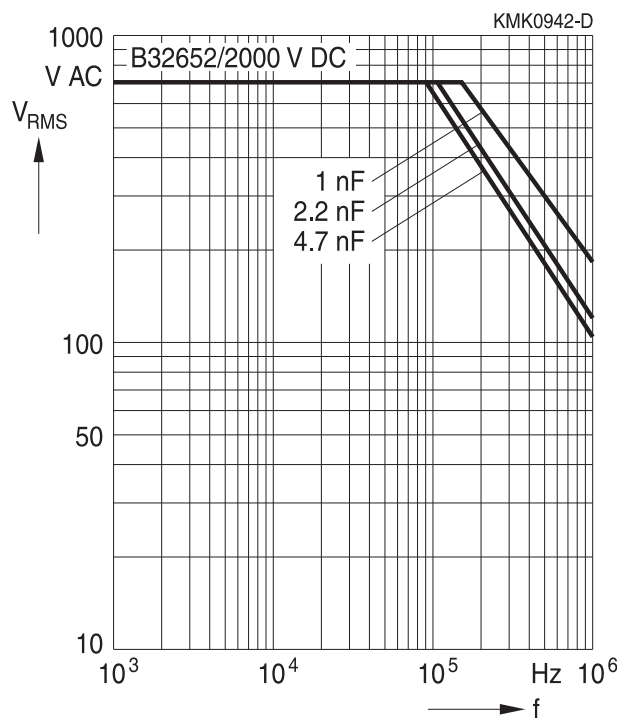



Permissible AC voltage V_{RMS} versus frequency f (for sinusoidal waveforms, $T_A \leq 90^\circ C$)

For $T_A > 90^\circ C$, please refer to "General technical information", section 3.2.3.

Lead spacing 22.5 mm

250 V DC/160 V AC

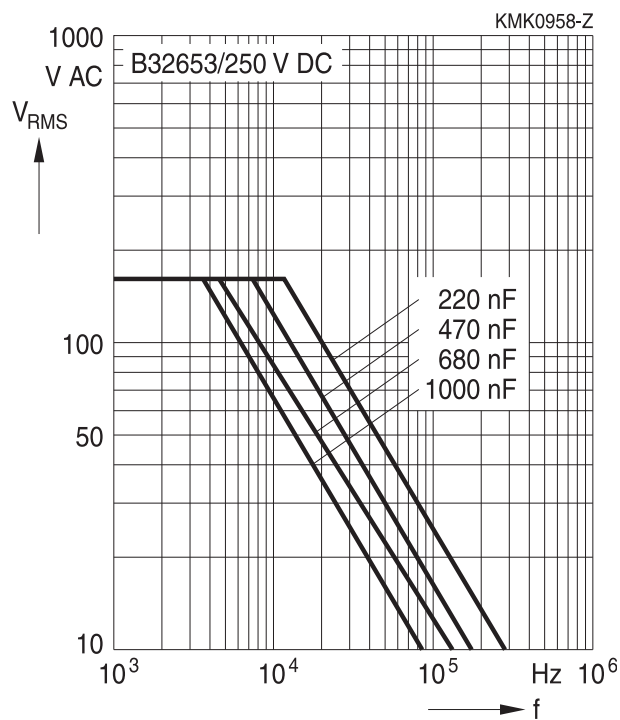

400 V DC/200 V AC

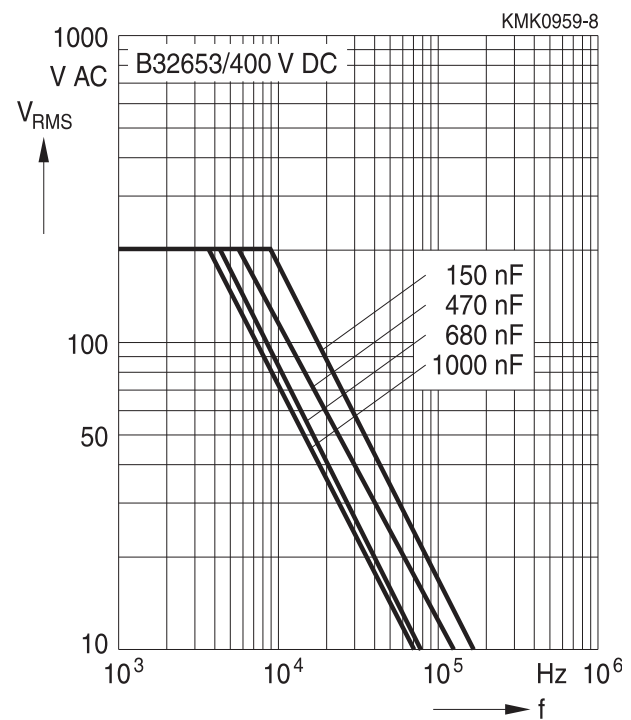

630 V DC/250 V AC

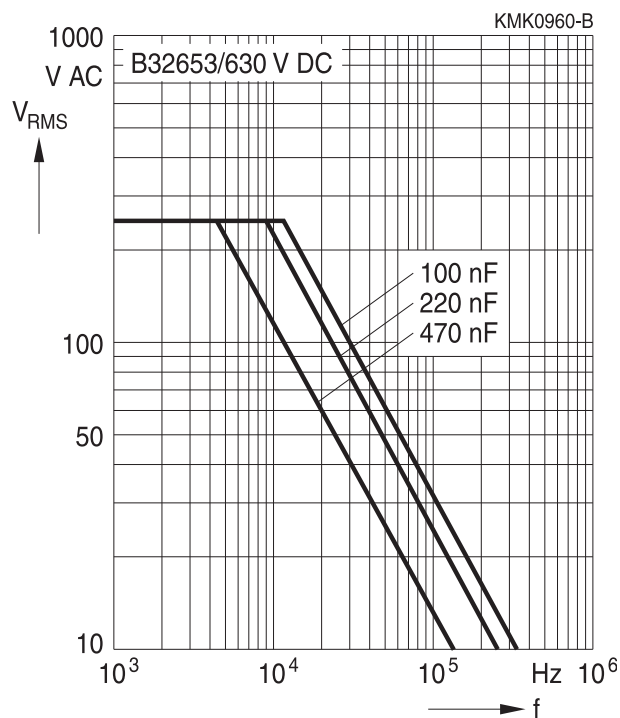

1000 V DC/250 V AC

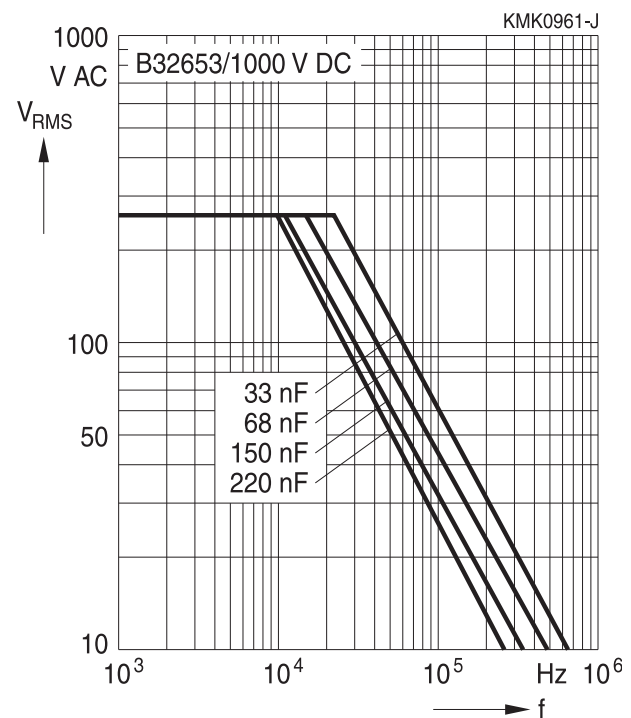

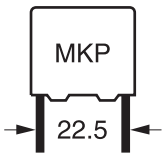

B32653

High pulse (wound)

Permissible AC voltage V_{RMS} versus frequency f (for sinusoidal waveforms, $T_A \leq 90^\circ C$)

For $T_A > 90^\circ C$, please refer to "General technical information", section 3.2.3.

Lead spacing 22.5 mm

1250 V DC/500 V AC

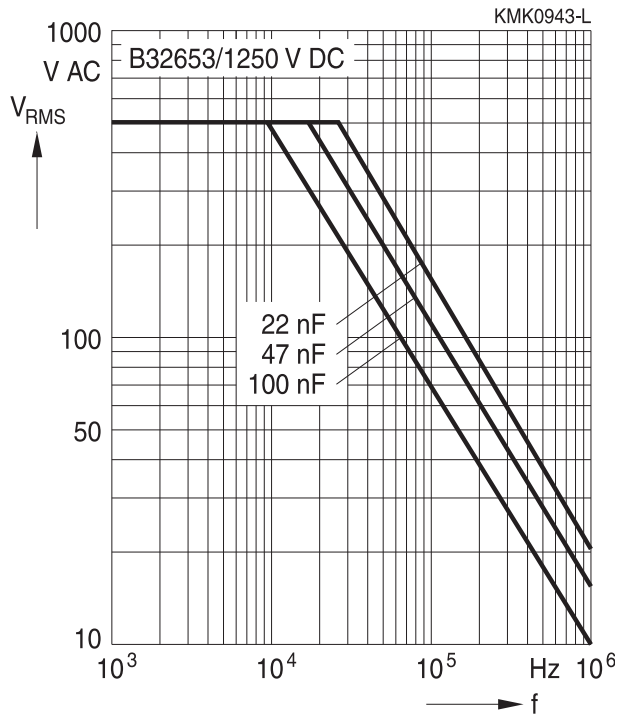

1600 V DC/500 V AC

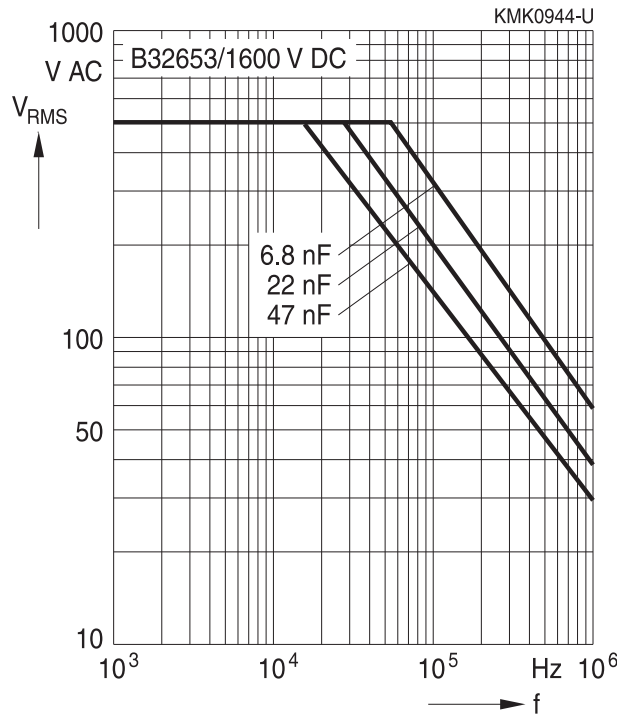

2000 V DC/700 V AC

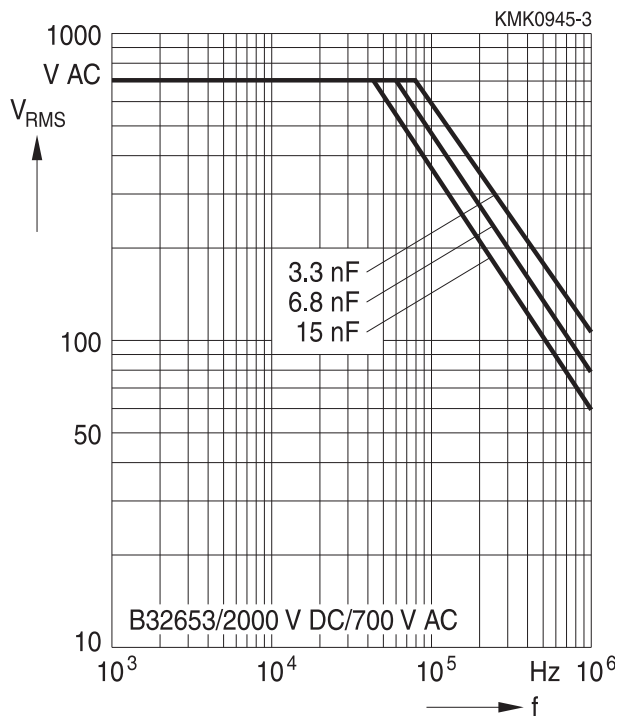

2000 V DC/1000 V AC

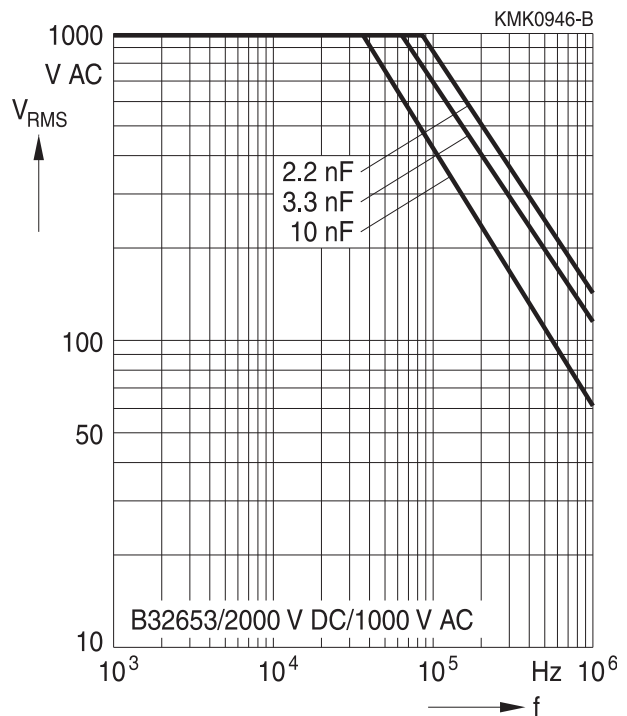

B32654

High pulse (wound)

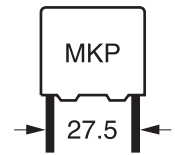

Permissible AC voltage V_{RMS} versus frequency f (for sinusoidal waveforms, $T_A \leq 90^\circ C$)

For $T_A > 90^\circ C$, please refer to "General technical information", section 3.2.3.

Lead spacing 27.5 mm

250 V DC/160 V AC

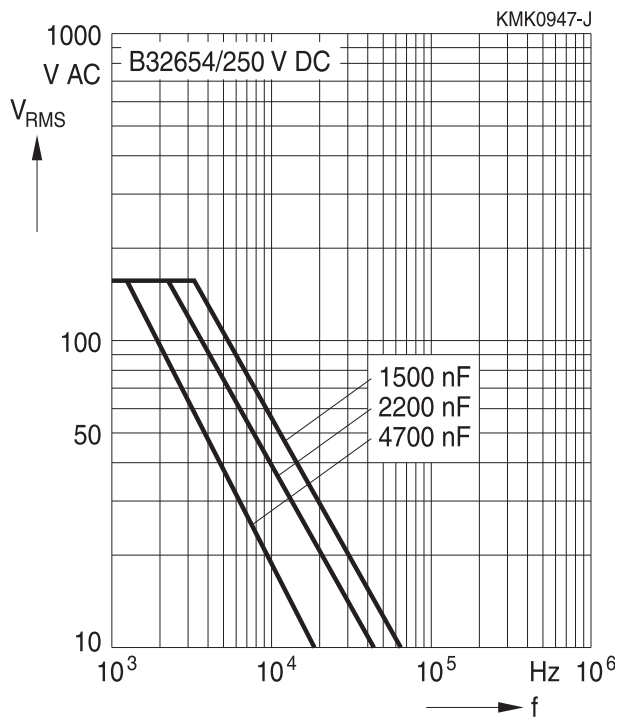

400 V DC/200 V AC

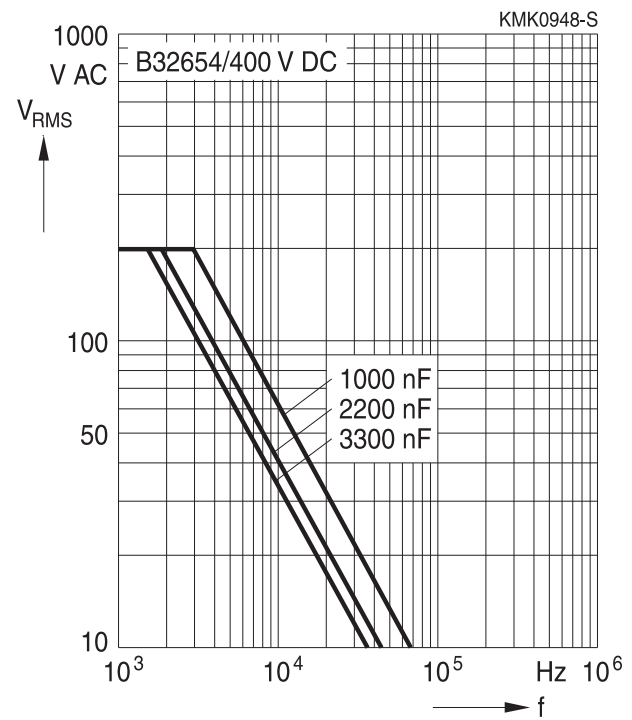

630 V DC/250 V AC

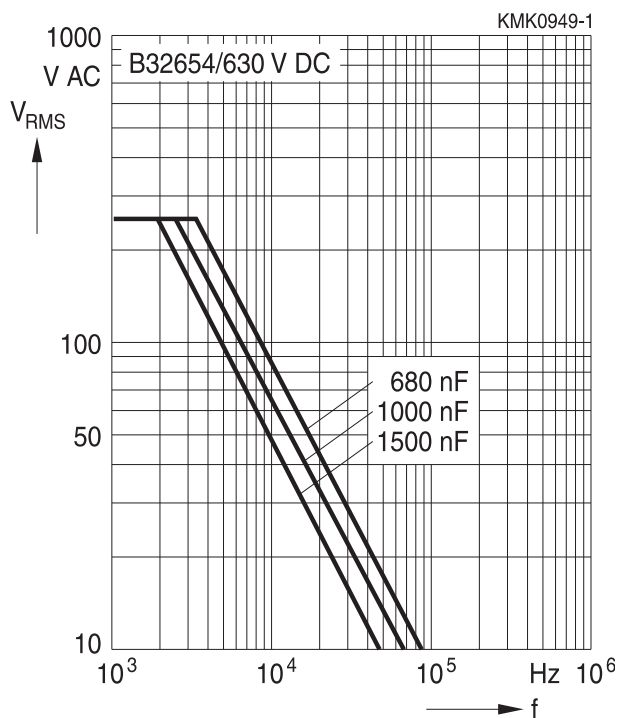

1000 V DC/250 V AC

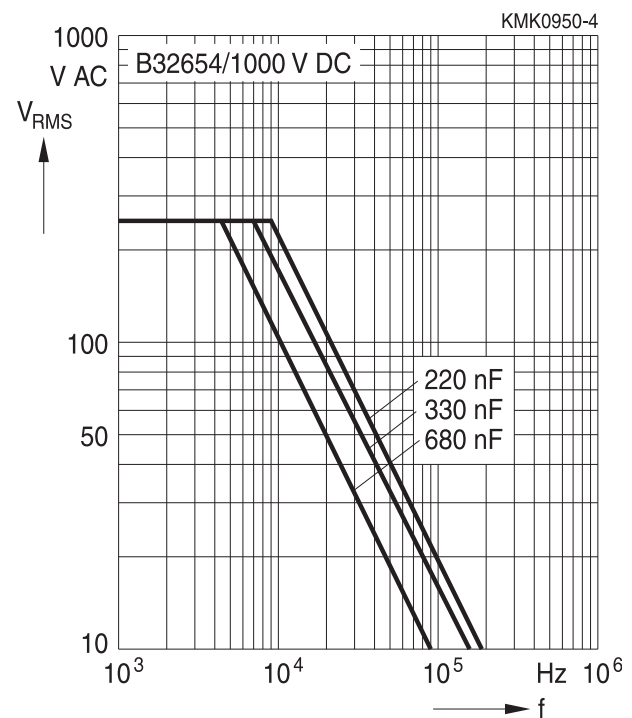



B32654

High pulse (wound)

Permissible AC voltage V_{RMS} versus frequency f (for sinusoidal waveforms, $T_A \leq 90^\circ C$)

For $T_A > 90^\circ C$, please refer to "General technical information", section 3.2.3.

Lead spacing 27.5 mm

1250 V DC/500 V AC

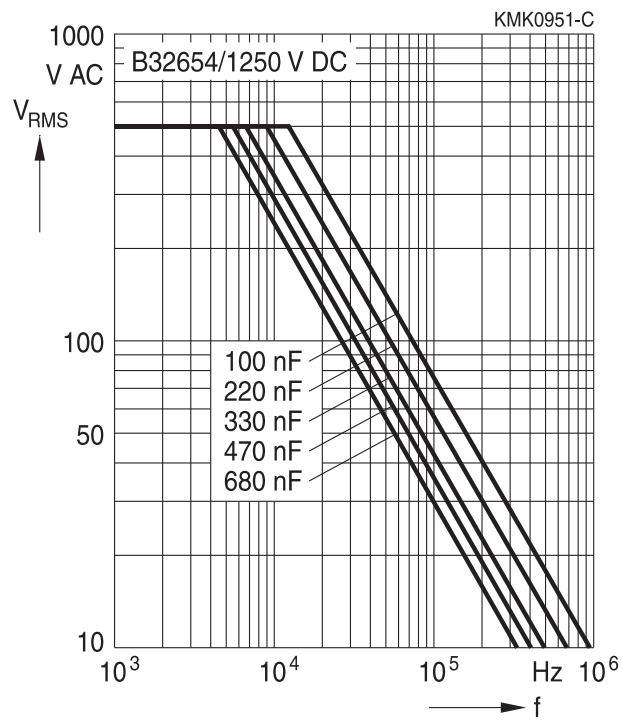

1600 V DC/500 V AC

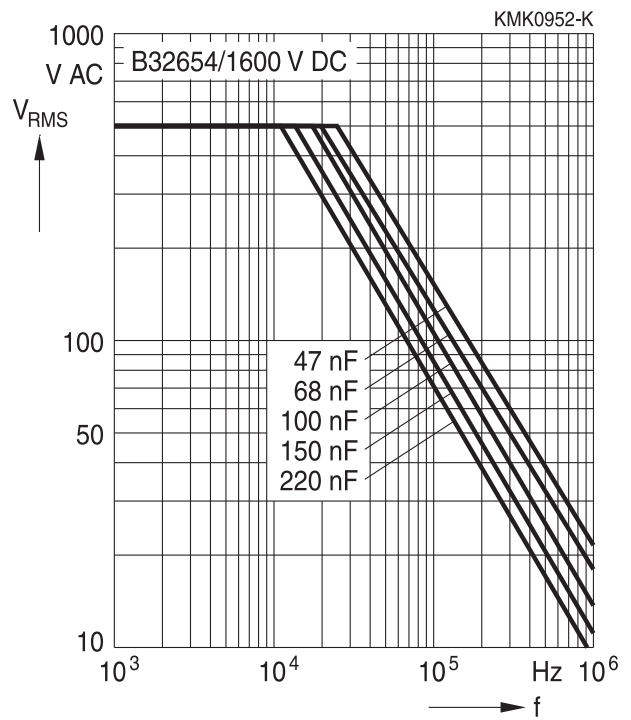

2000 V DC/700 V AC

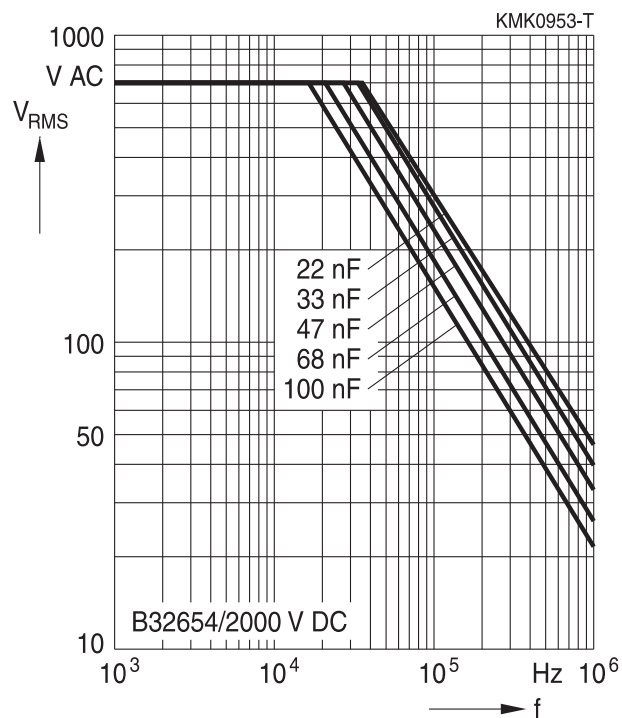

B32656

High pulse (wound)

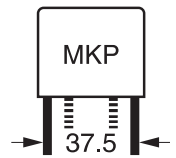

Permissible AC voltage V_{RMS} versus frequency f (for sinusoidal waveforms, $T_A \leq 90^\circ C$)

For $T_A > 90^\circ C$, please refer to "General technical information", section 3.2.3.

Lead spacing 37.5 mm

250 V DC/160 V AC, B32656A3

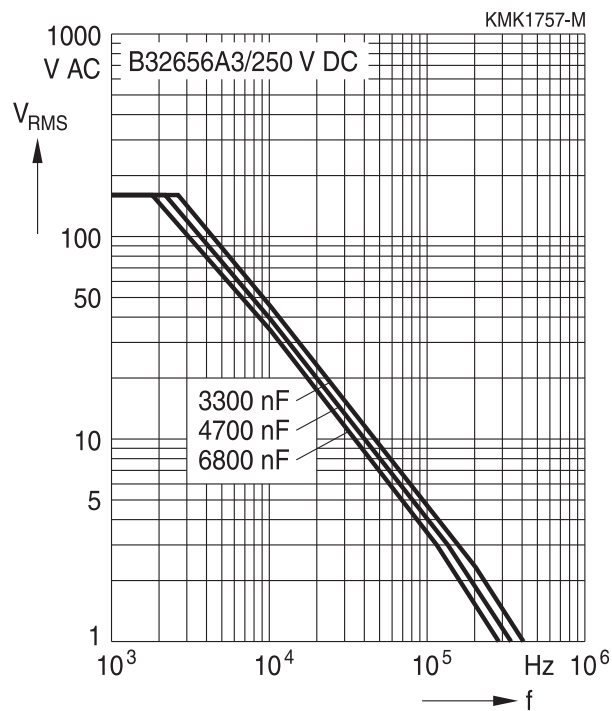

250 V DC/160 V AC, B32656G3

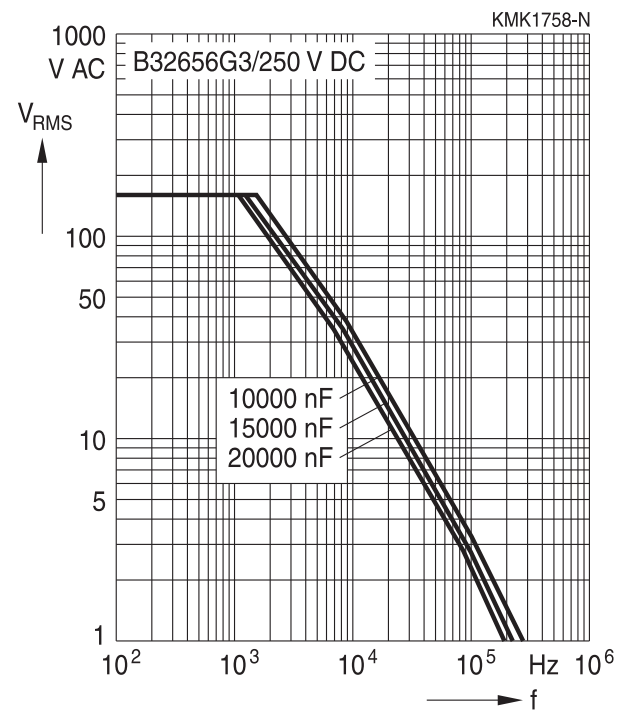

250 V DC/160 V AC, B32656T3

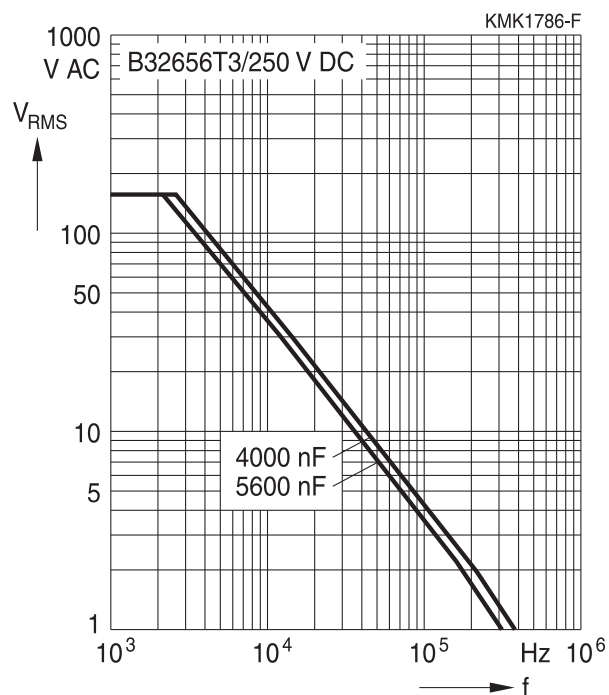



B32656

High pulse (wound)

Permissible AC voltage V_{RMS} versus frequency f (for sinusoidal waveforms, $T_A \leq 90^\circ C$)

For $T_A > 90^\circ C$, please refer to "General technical information", section 3.2.3.

Lead spacing 37.5 mm

400 V DC/200 V AC, B32656A4

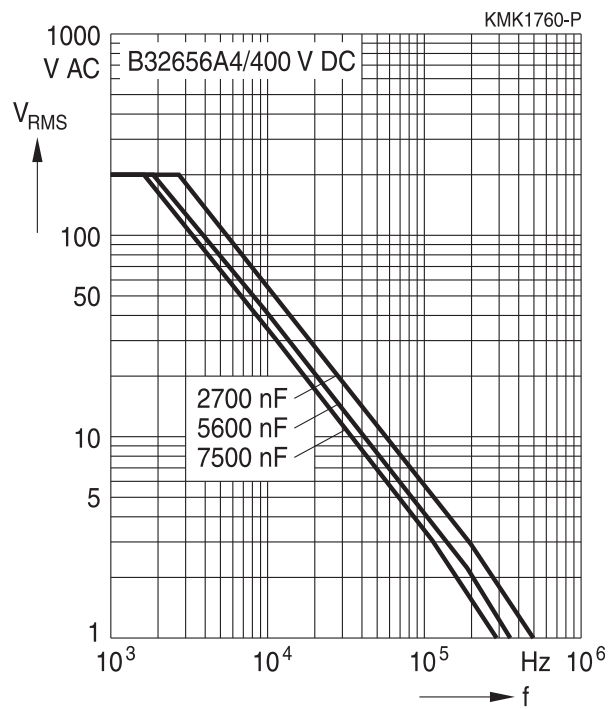

400 V DC/200 V AC, B32656G4

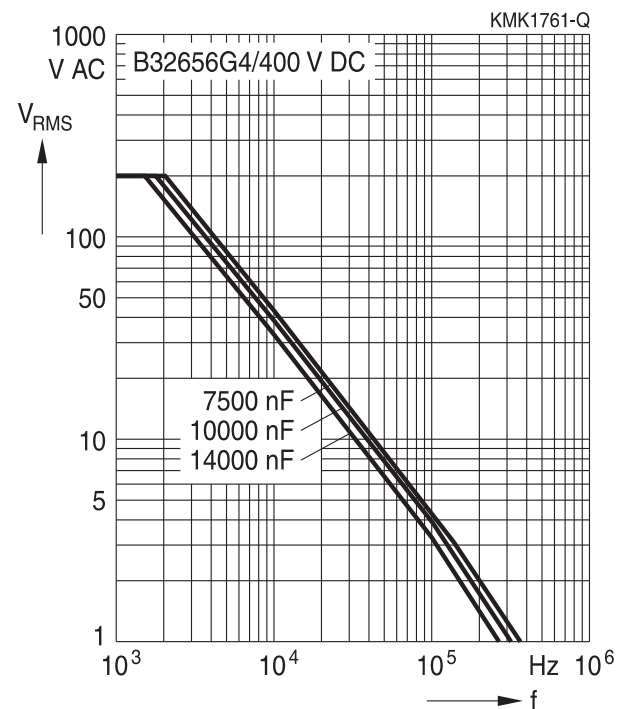

400 V DC/200 V AC, B32656T4

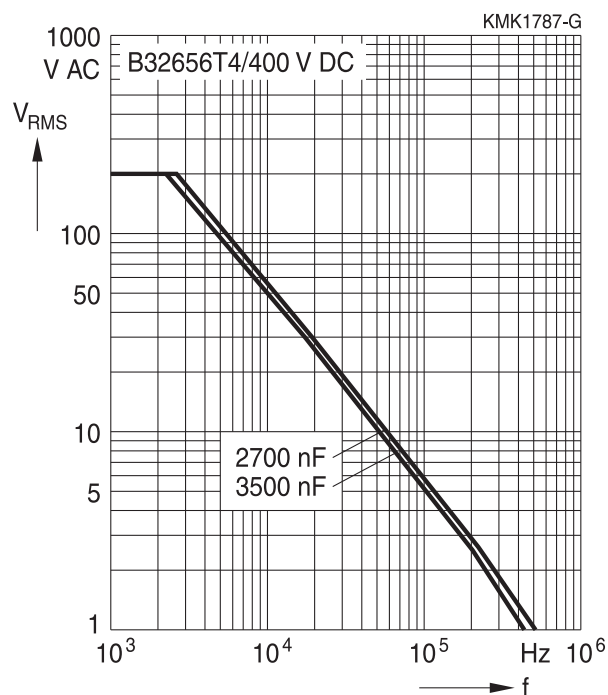

B32656

High pulse (wound)



Permissible AC voltage V_{RMS} versus frequency f (for sinusoidal waveforms, $T_A \leq 90^\circ C$)

For $T_A > 90^\circ C$, please refer to "General technical information", section 3.2.3.

Lead spacing 37.5 mm

630 V DC/250 V AC, B32656A6

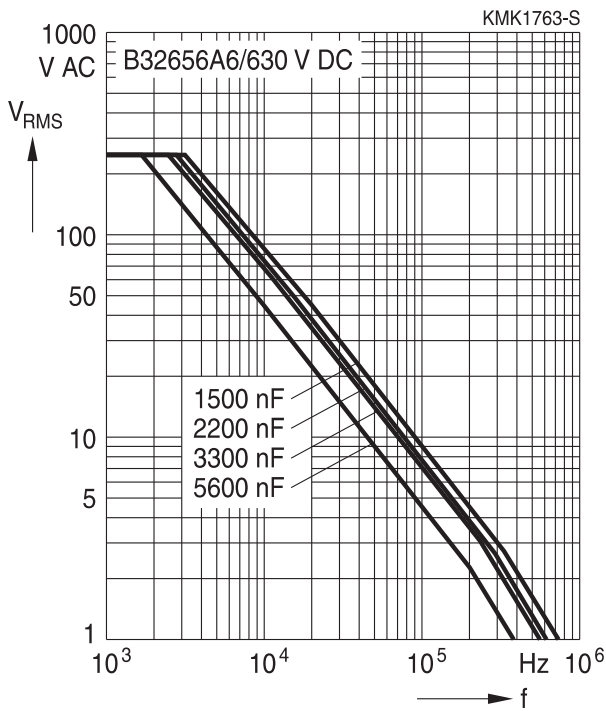

630 V DC/250 V AC, B32656G6

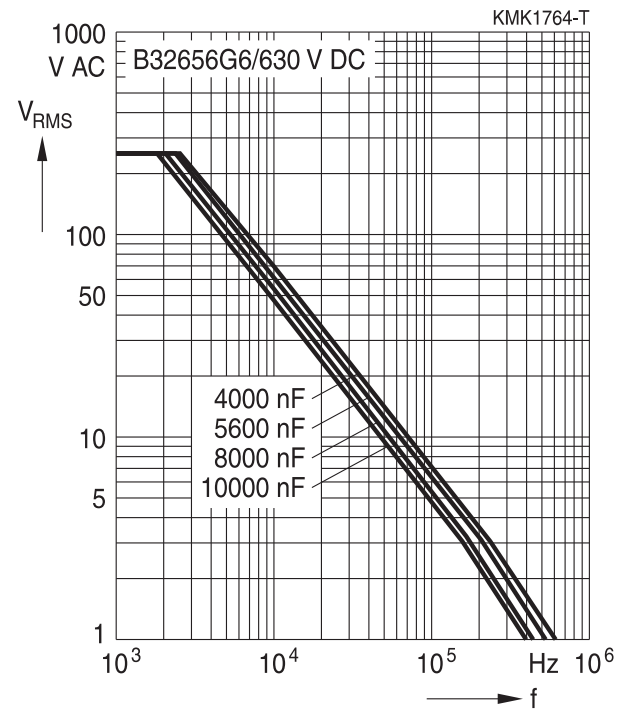

630 V DC/250 V AC, B32656T6

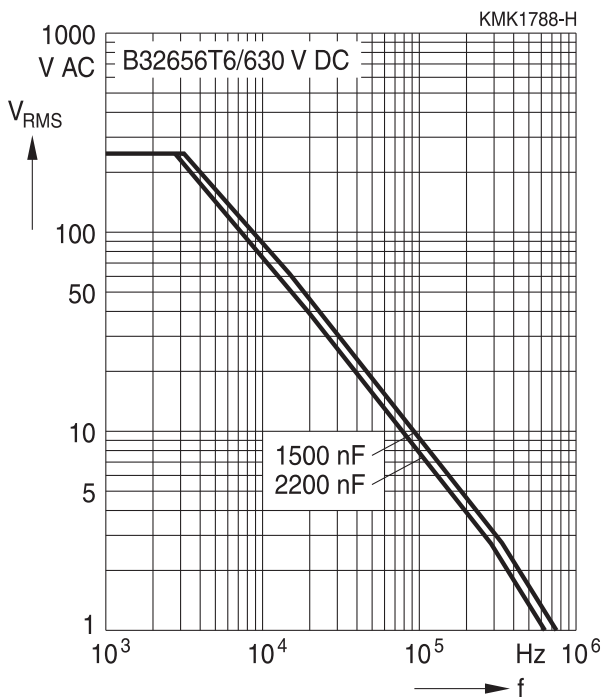

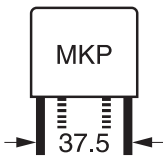

B32656

High pulse (wound)

Permissible AC voltage V_{RMS} versus frequency f (for sinusoidal waveforms, $T_A \leq 90^\circ C$)

For $T_A > 90^\circ C$, please refer to "General technical information", section 3.2.3.

Lead spacing 37.5 mm

750 V DC/350 V AC, B32656A5

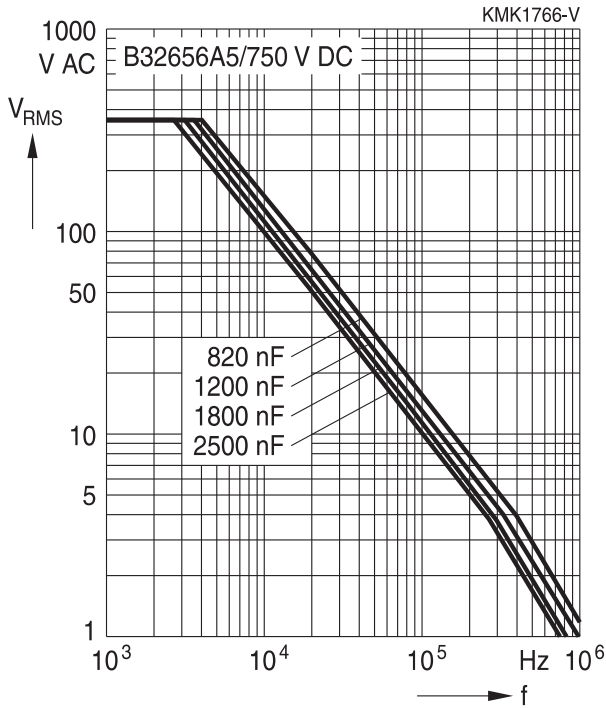

750 V DC/350 V AC, B32656G5

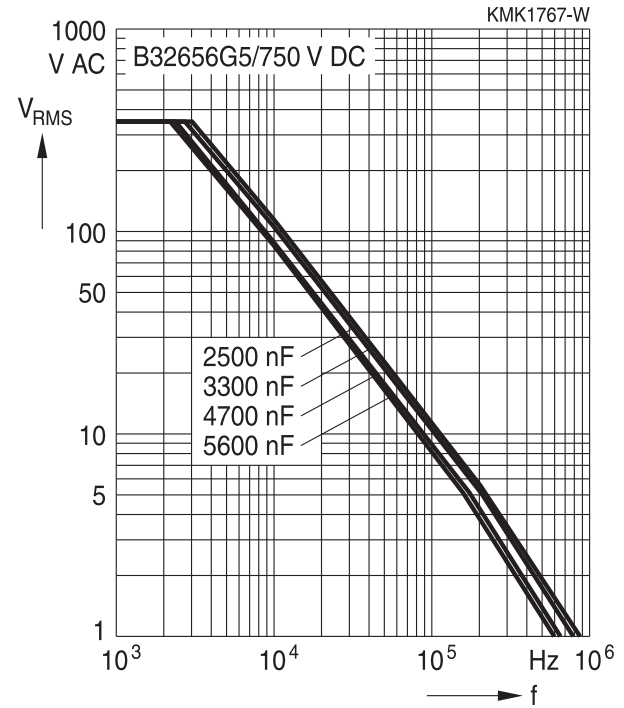

750 V DC/350 V AC, B32656T5

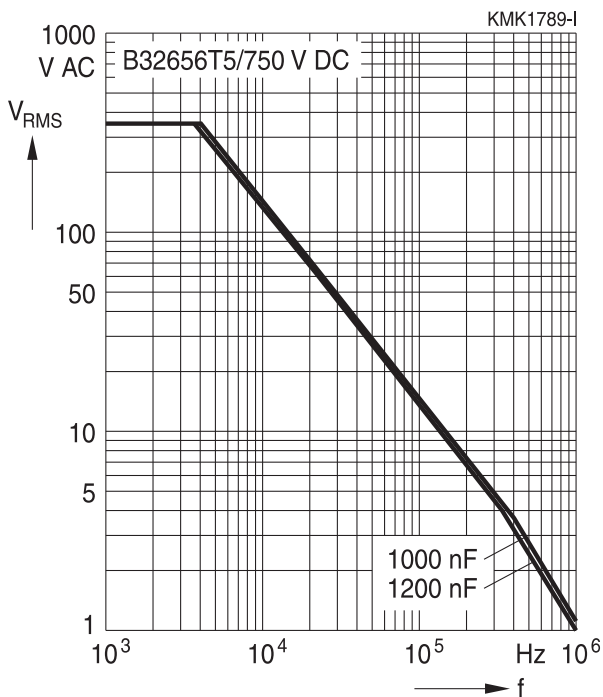

B32656

High pulse (wound)



Permissible AC voltage V_{RMS} versus frequency f (for sinusoidal waveforms, $T_A \leq 90^\circ C$)

For $T_A > 90^\circ C$, please refer to "General technical information", section 3.2.3.

Lead spacing 37.5 mm

850 V DC/450 V AC, B32656A8

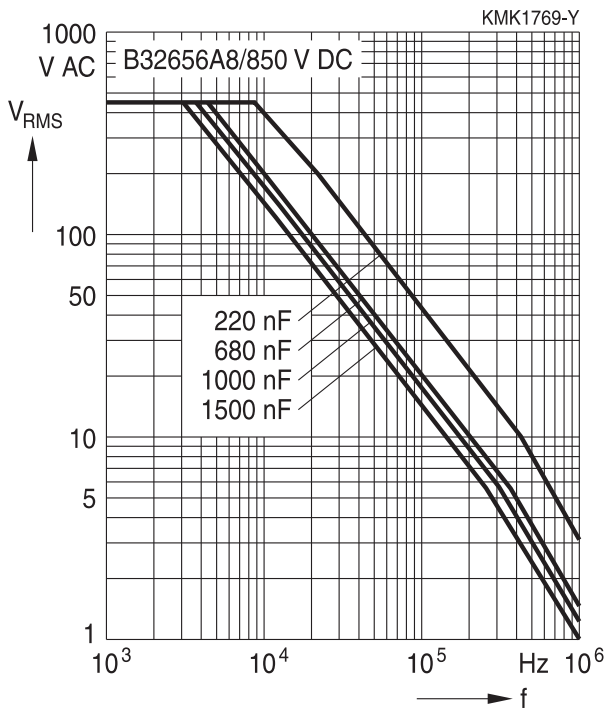

850 V DC/450 V AC, B32656G8

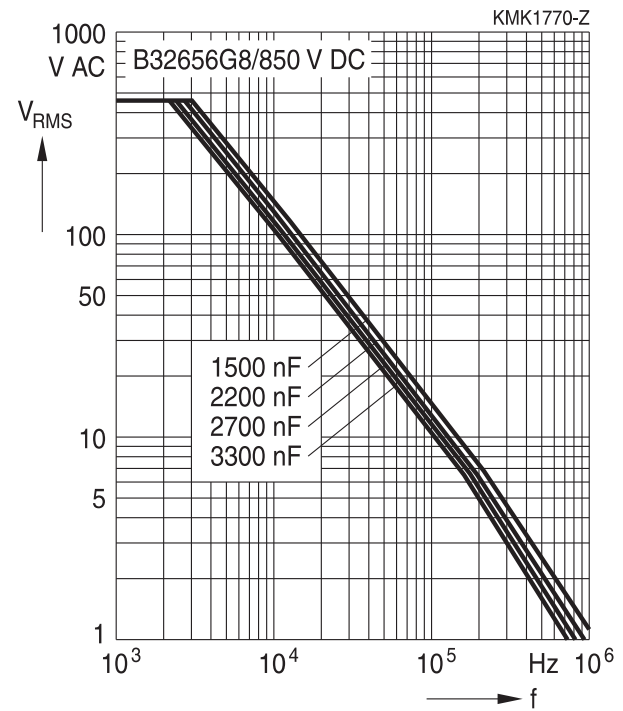

850 V DC/450 V AC, B32656T8

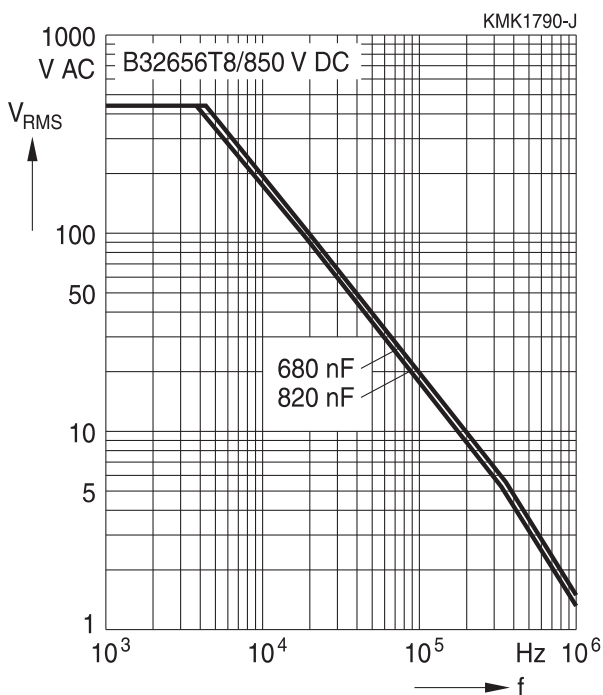



B32656

High pulse (wound)

Permissible AC voltage V_{RMS} versus frequency f (for sinusoidal waveforms, $T_A \leq 90^\circ\text{C}$)

For $T_A > 90^\circ\text{C}$, please refer to "General technical information", section 3.2.3.

Lead spacing 37.5 mm

1000 V DC/500 V AC, B32656A0

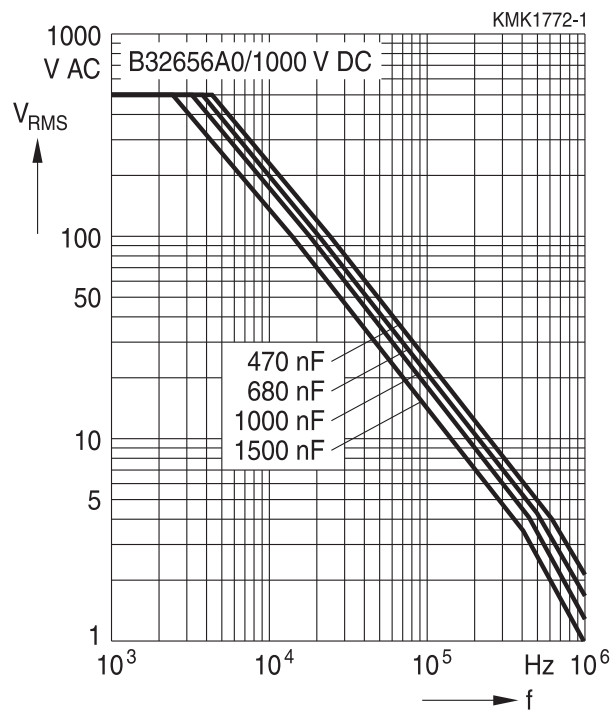

1000 V DC/500 V AC, B32656G0

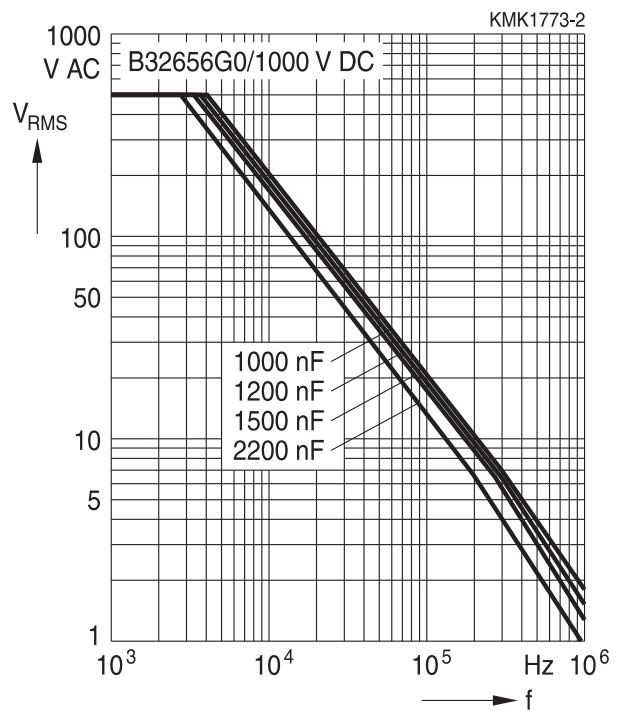

1000 V DC/500 V AC, B32656T0

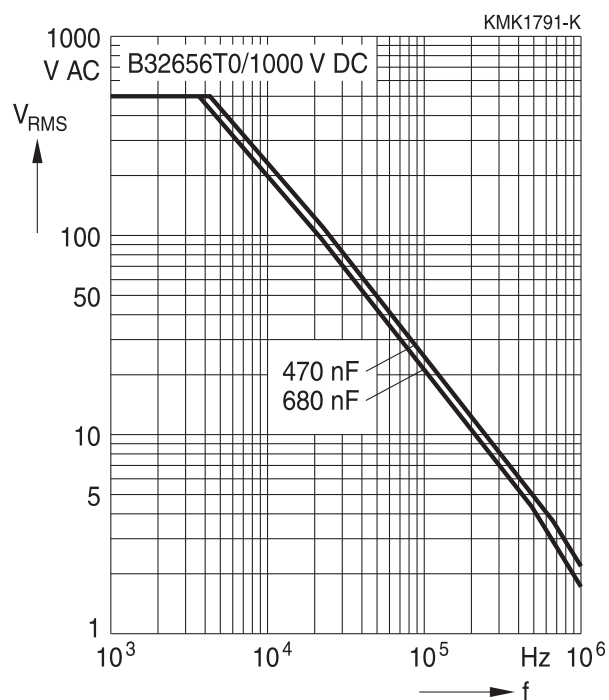

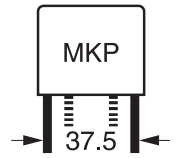

Permissible AC voltage V_{RMS} versus frequency f (for sinusoidal waveforms, $T_A \leq 90\text{ }^\circ\text{C}$)

For $T_A > 90\text{ }^\circ\text{C}$, please refer to "General technical information", section 3.2.3.

Lead spacing 37.5 mm

1250 V DC/500 V AC, B32656A7

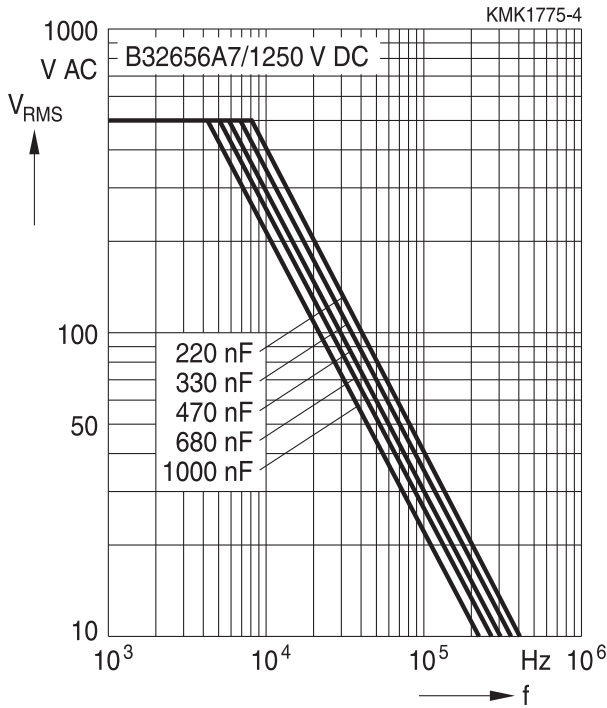

1250 V DC/500 V AC, B32656G7

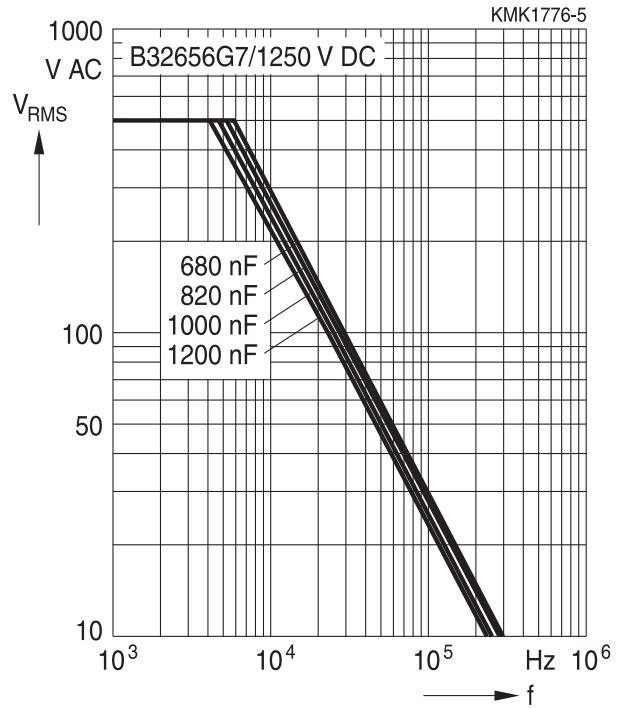

1250 V DC/500 V AC, B32656T7

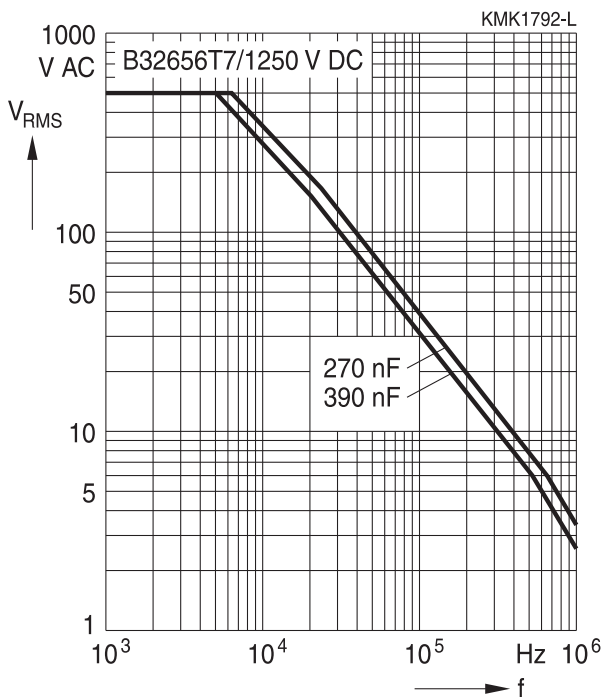

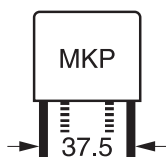

B32656

High pulse (wound)

Permissible AC voltage V_{RMS} versus frequency f (for sinusoidal waveforms, $T_A \leq 90^\circ C$)

For $T_A > 90^\circ C$, please refer to "General technical information", section 3.2.3.

Lead spacing 37.5 mm

1600 V DC/600 V AC, B32656J1

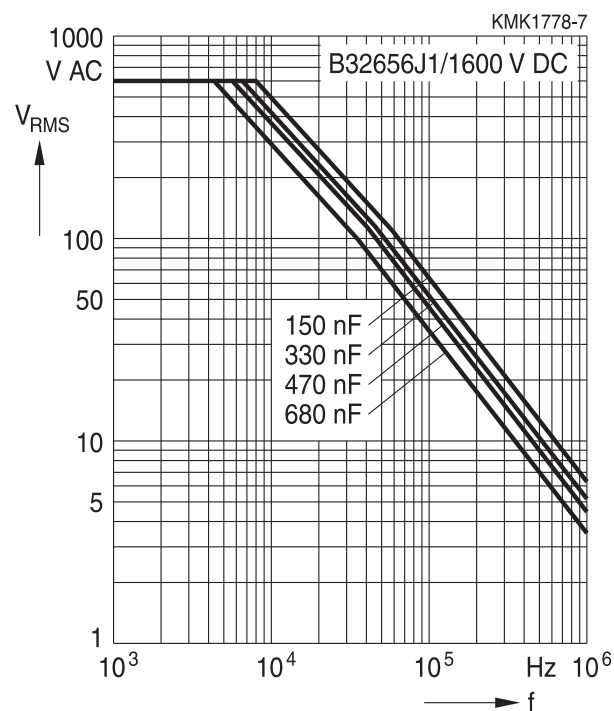

1600 V DC/600 V AC, B32656G1

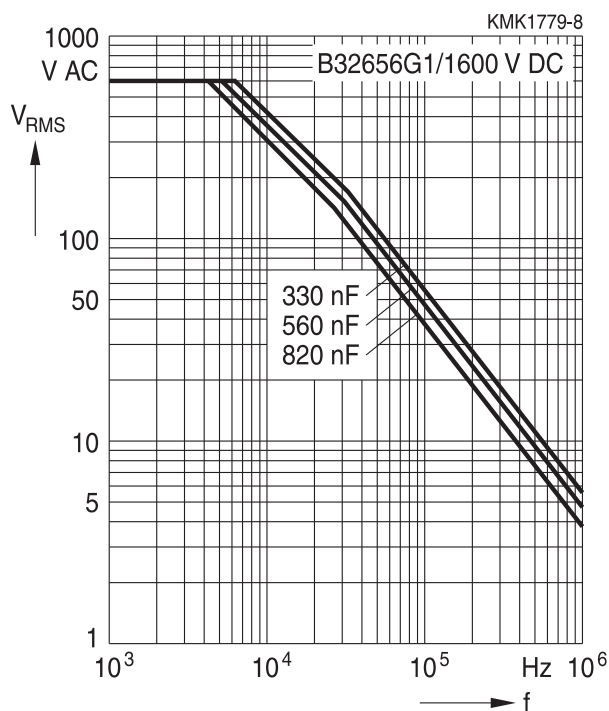

1600 V DC/600 V AC, B32656T1

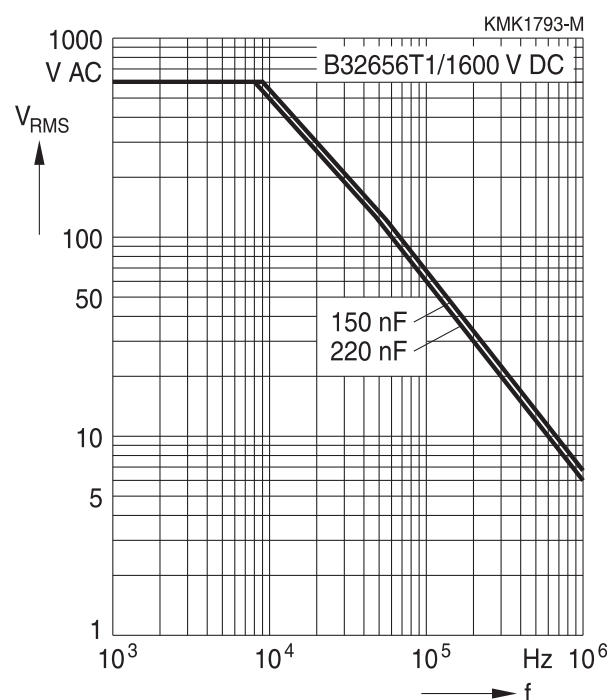

B32656

High pulse (wound)



Permissible AC voltage V_{RMS} versus frequency f (for sinusoidal waveforms, $T_A \leq 90^\circ\text{C}$)

For $T_A > 90^\circ\text{C}$, please refer to "General technical information", section 3.2.3.

Lead spacing 37.5 mm

2000 V DC/700 V AC, B32656J2

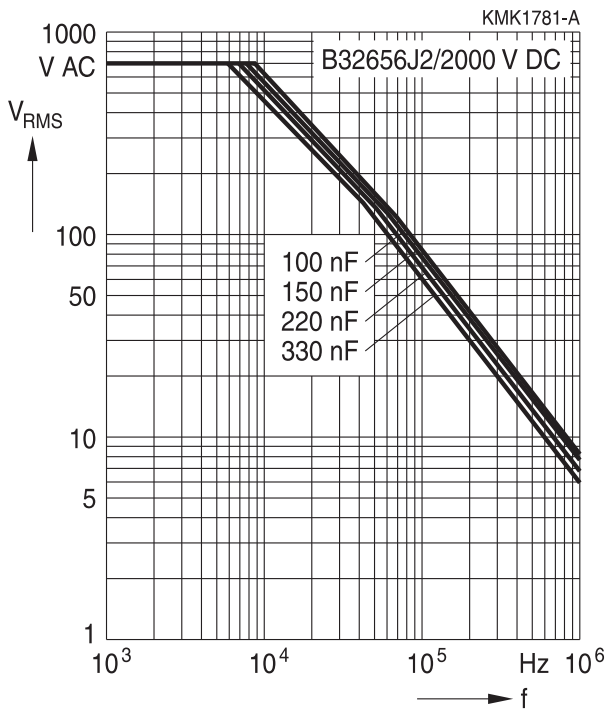

2000 V DC/700 V AC, B32656G2

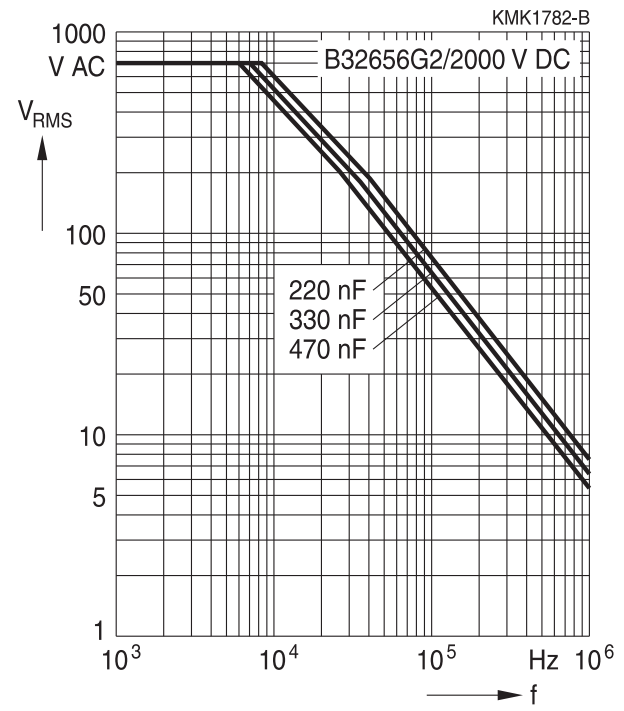

2000 V DC/700 V AC, B32656T2

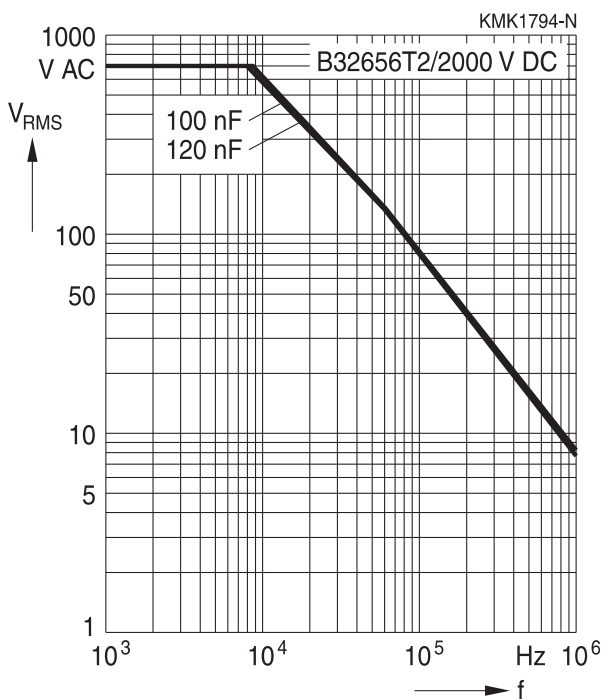

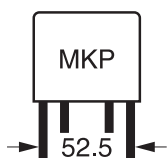

B32658

High pulse (wound)

Permissible AC voltage V_{RMS} versus frequency f (for sinusoidal waveforms, $T_A \leq 90^\circ\text{C}$)

For $T_A > 90^\circ\text{C}$, please refer to "General technical information", section 3.2.3.

Lead spacing 52.5 mm

250 V DC/160 V AC, B32658G3

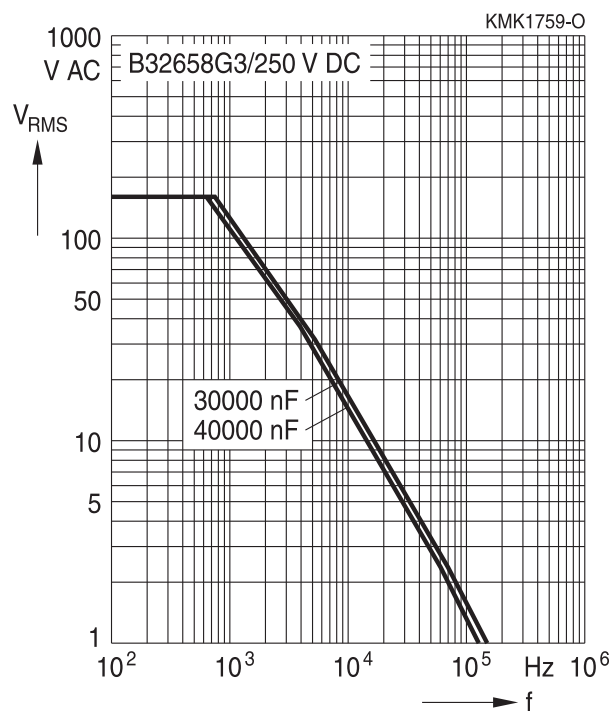

400 V DC/200 V AC, B32658G4

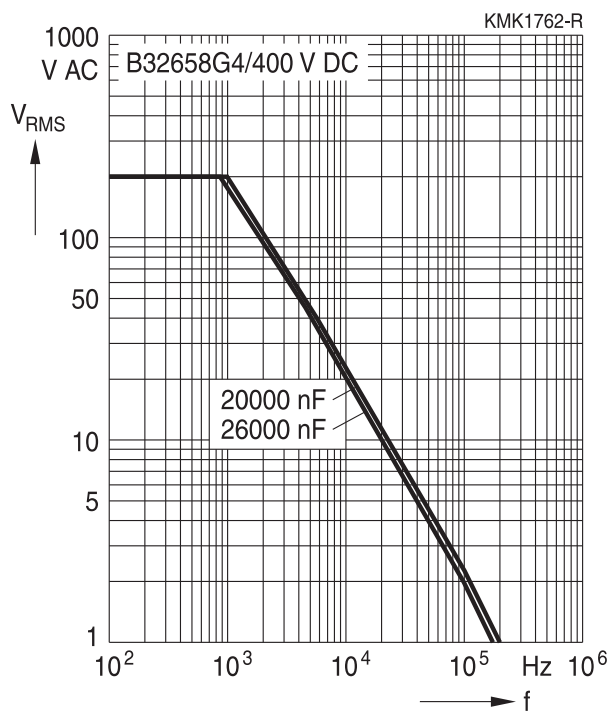

630 V DC/250 V AC, B32658G6

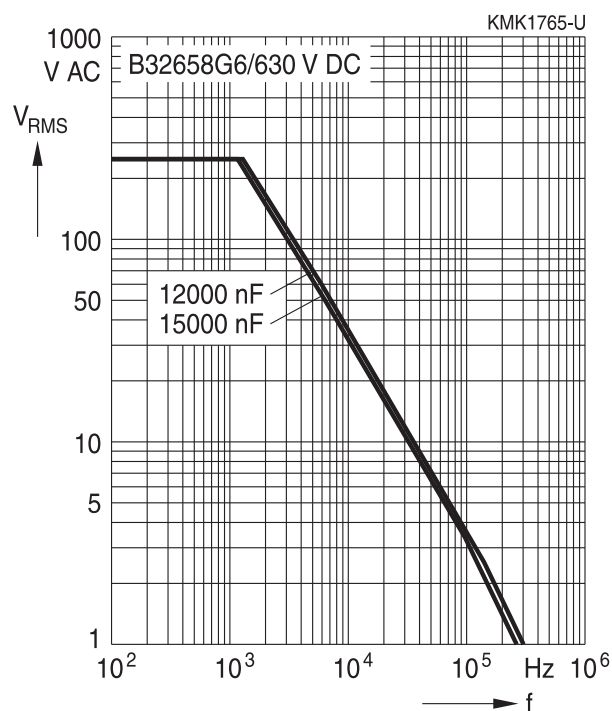

750 V DC/350 V AC, B32658G5

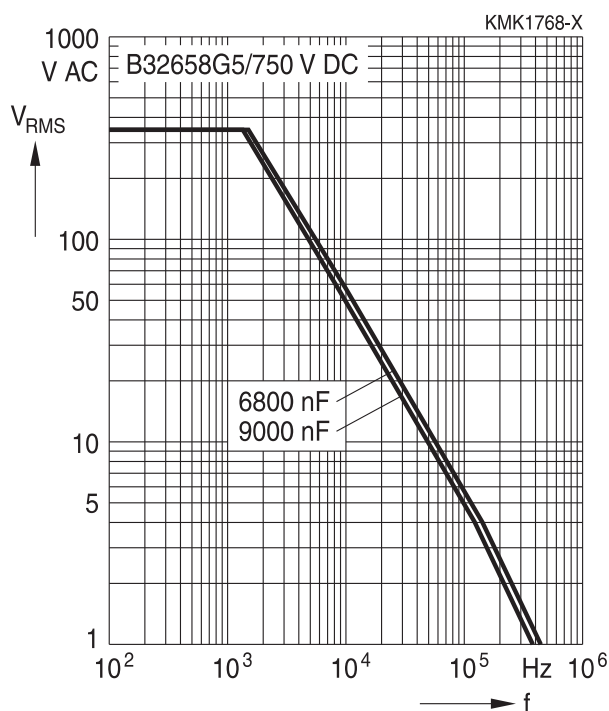

B32658

High pulse (wound)



Permissible AC voltage V_{RMS} versus frequency f (for sinusoidal waveforms, $T_A \leq 90^\circ C$)

For $T_A > 90^\circ C$, please refer to "General technical information", section 3.2.3.

Lead spacing 52.5 mm

850 V DC/450 V AC, B32658G8

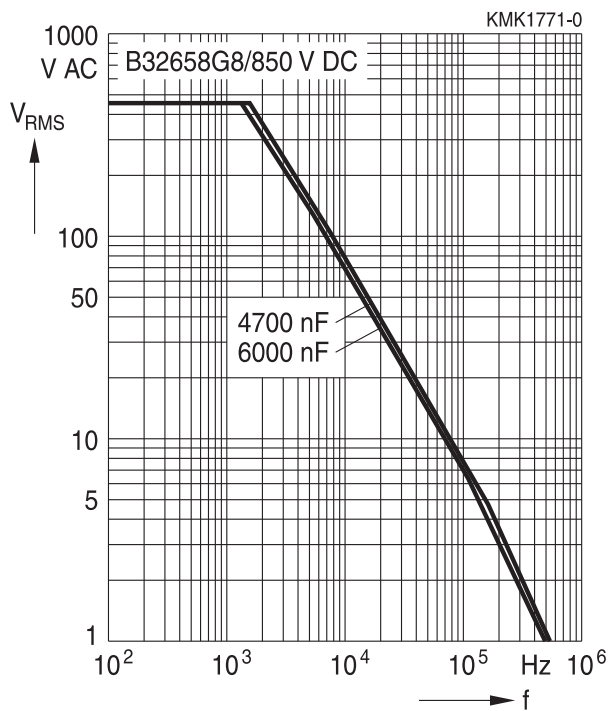

1000 V DC/500 V AC, B32658G0

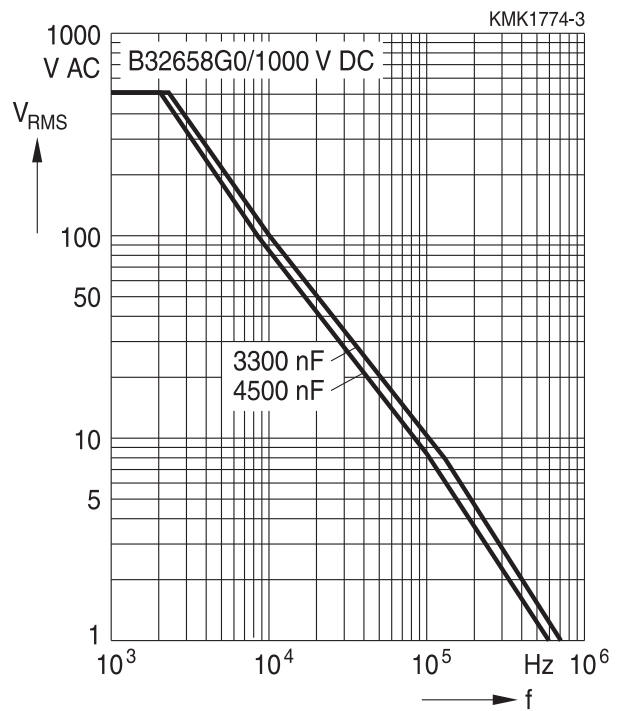

1250 V DC/500 V AC, B32658G7

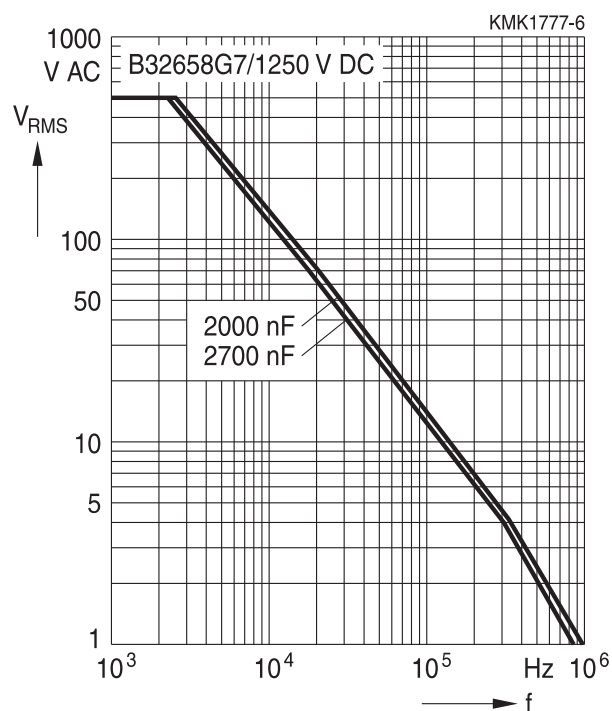

1600 V DC/600 V AC, B32658G1

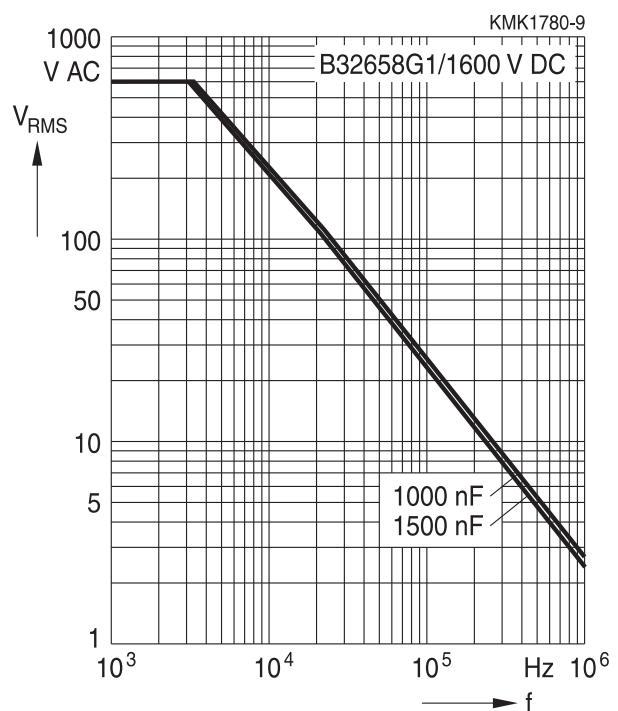

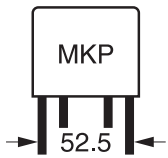

B32658

High pulse (wound)

Permissible AC voltage V_{RMS} versus frequency f (for sinusoidal waveforms, $T_A \leq 90^\circ\text{C}$)

For $T_A > 90^\circ\text{C}$, please refer to "General technical information", section 3.2.3.

Lead spacing 52.5 mm

2000 V DC/700 V AC, B32658G2

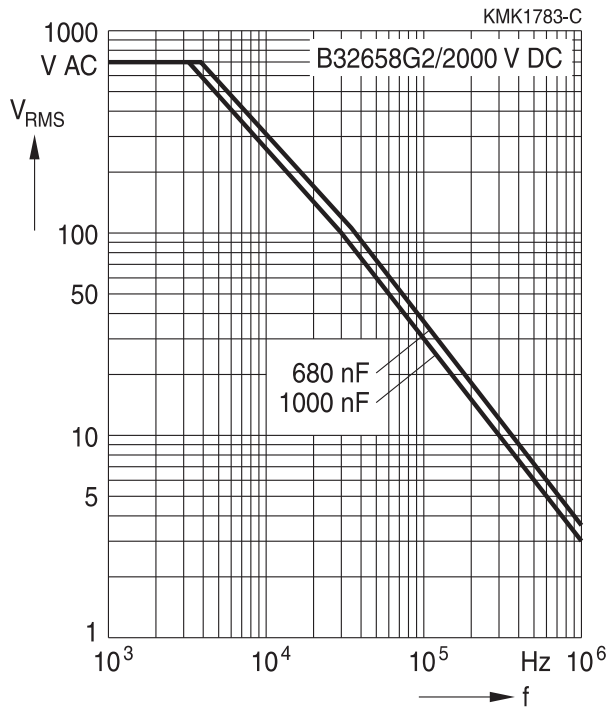



Mounting guidelines

1 Soldering

1.1 Solderability of leads

The solderability of terminal leads is tested to IEC 60068-2-20, test Ta, method 1.

Before a solderability test is carried out, terminals are subjected to accelerated ageing (to IEC 60068-2-2, test Ba: 4 h exposure to dry heat at 155 °C). Since the ageing temperature is far higher than the upper category temperature of the capacitors, the terminal wires should be cut off from the capacitor before the ageing procedure to prevent the solderability being impaired by the products of any capacitor decomposition that might occur.

Solder bath temperature	235 ±5 °C
Soldering time	2.0 ±0.5 s
Immersion depth	2.0 +0/−0.5 mm from capacitor body or seating plane
Evaluation criteria:	
Visual inspection	Wetting of wire surface by new solder ≥90%, free-flowing solder

1.2 Resistance to soldering heat

Resistance to soldering heat is tested to IEC 60068-2-20, test Tb, method 1A.

Conditions:

Series	Solder bath temperature	Soldering time
MKT boxed (except 2.5 × 6.5 × 7.2 mm) coated uncoated (lead spacing > 10 mm)	260 ±5 °C	10 ±1 s
MFP MKP (lead spacing > 7.5 mm)		
MKT boxed (case 2.5 × 6.5 × 7.2 mm)		5 ±1 s
MKP (lead spacing ≤ 7.5 mm)		< 4 s
MKT uncoated (lead spacing ≤ 10 mm) insulated (B32559)		recommended soldering profile for MKT uncoated (lead spacing ≤ 10 mm) and insulated (B32559)



B32651 ... B32658

High pulse (wound)

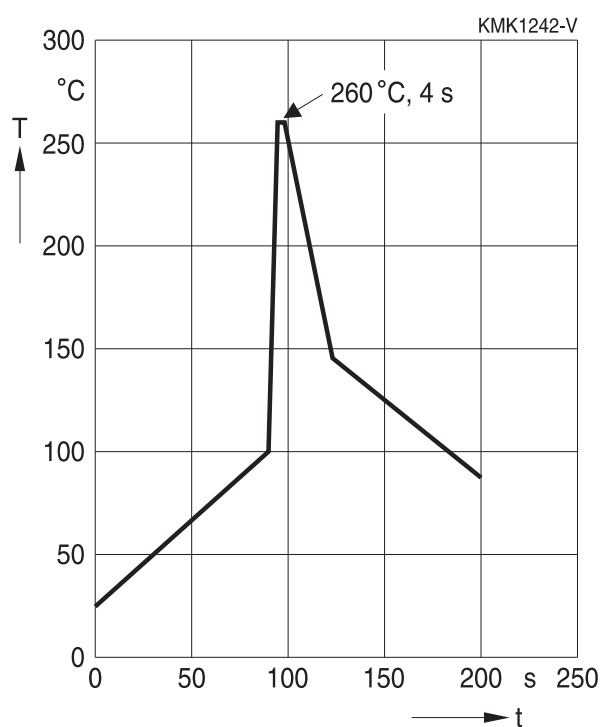

Immersion depth	2.0 +0/−0.5 mm from capacitor body or seating plane
Shield	Heat-absorbing board, (1.5 ±0.5) mm thick, between capacitor body and liquid solder
Evaluation criteria:	
Visual inspection	No visible damage
$\Delta C/C_0$	2% for MKT/MKP/MFP 5% for EMI suppression capacitors
$\tan \delta$	As specified in sectional specification



1.3 General notes on soldering

Permissible heat exposure loads on film capacitors are primarily characterized by the upper category temperature T_{max} . Long exposure to temperatures above this type-related temperature limit can lead to changes in the plastic dielectric and thus change irreversibly a capacitor's electrical characteristics. For short exposures (as in practical soldering processes) the heat load (and thus the possible effects on a capacitor) will also depend on other factors like:

- Pre-heating temperature and time
- Forced cooling immediately after soldering
- Terminal characteristics:
diameter, length, thermal resistance, special configurations (e.g. crimping)
- Height of capacitor above solder bath
- Shadowing by neighboring components
- Additional heating due to heat dissipation by neighboring components
- Use of solder-resist coatings

The overheating associated with some of these factors can usually be reduced by suitable countermeasures. For example, if a pre-heating step cannot be avoided, an additional or reinforced cooling process may possibly have to be included.

EPCOS recommendations

As a reference, the recommended wave soldering profile for our film capacitors is as follows:

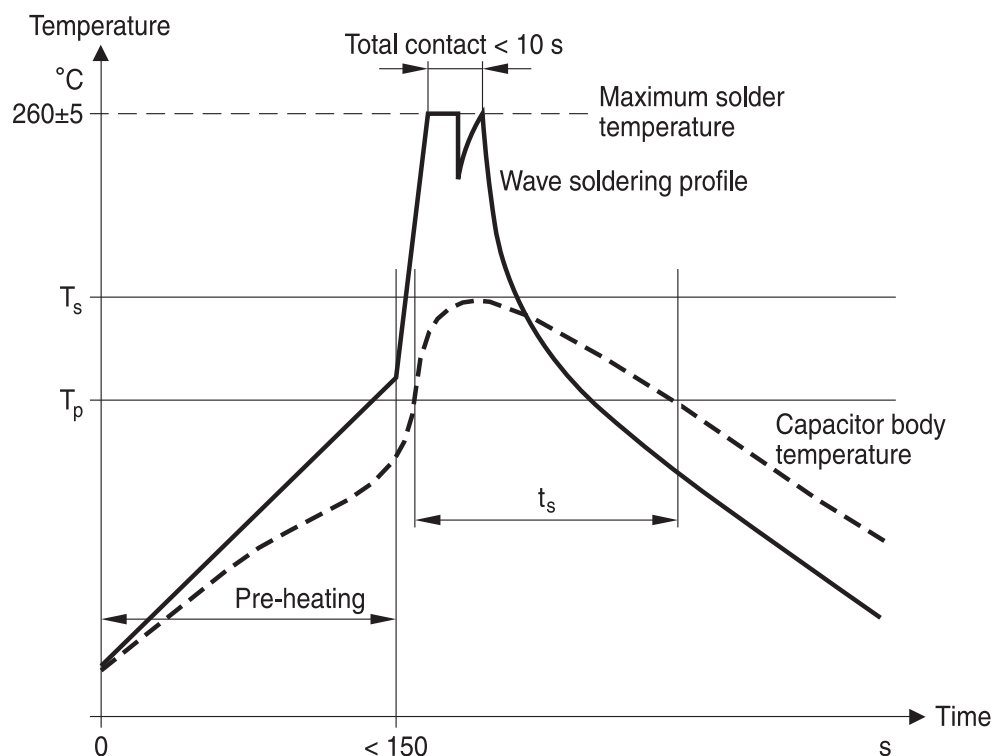

T_s : Capacitor body maximum temperature at wave soldering

T_p : Capacitor body maximum temperature at pre-heating

KMK1745-A-E



B32651 ... B32658

High pulse (wound)

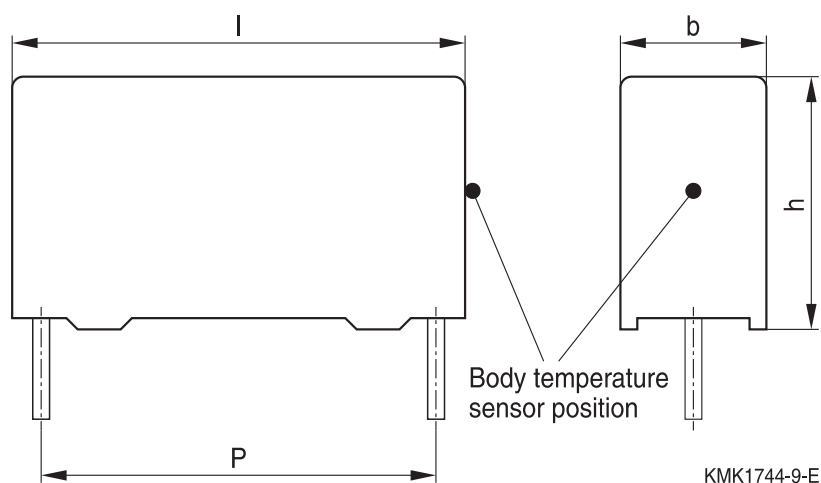

Body temperature should follow the description below:

- MKP capacitor
 - During pre-heating: $T_p \leq 110\text{ °C}$
 - During soldering: $T_s \leq 120\text{ °C}$, $t_s \leq 45\text{ s}$
- MKT capacitor
 - During pre-heating: $T_p \leq 125\text{ °C}$
 - During soldering: $T_s \leq 160\text{ °C}$, $t_s \leq 45\text{ s}$

When SMD components are used together with leaded ones, the film capacitors should not pass into the SMD adhesive curing oven. The leaded components should be assembled after the SMD curing step.

Leaded film capacitors are not suitable for reflow soldering.

In order to ensure proper conditions for manual or selective soldering, the body temperature of the capacitor (T_s) must be $\leq 120\text{ °C}$.

One recommended condition for manual soldering is that the tip of the soldering iron should be $< 360\text{ °C}$ and the soldering contact time should be no longer than 3 seconds.

For uncoated MKT capacitors with lead spacings $\leq 10\text{ mm}$ (B32560/B32561) the following measures are recommended:

- pre-heating to not more than 110 °C in the preheater phase
- rapid cooling after soldering

Please refer to EPCOS Film Capacitor Data Book in case more details are needed.



Cautions and warnings

- Do not exceed the upper category temperature (UCT).
- Do not apply any mechanical stress to the capacitor terminals.
- Avoid any compressive, tensile or flexural stress.
- Do not move the capacitor after it has been soldered to the PC board.
- Do not pick up the PC board by the soldered capacitor.
- Do not place the capacitor on a PC board whose PTH hole spacing differs from the specified lead spacing.
- Do not exceed the specified time or temperature limits during soldering.
- Avoid external energy inputs, such as fire or electricity.
- Avoid overload of the capacitors.

The table below summarizes the safety instructions that must always be observed. A detailed description can be found in the relevant sections of the chapters "General technical information" and "Mounting guidelines".

Topic	Safety information	Reference chapter "General technical information"
Storage conditions	Make sure that capacitors are stored within the specified range of time, temperature and humidity conditions.	4.5 "Storage conditions"
Flammability	Avoid external energy, such as fire or electricity (passive flammability), avoid overload of the capacitors (active flammability) and consider the flammability of materials.	5.3 "Flammability"
Resistance to vibration	Do not exceed the tested ability to withstand vibration. The capacitors are tested to IEC 60068-2-6. EPCOS offers film capacitors specially designed for operation under more severe vibration regimes such as those found in automotive applications. Consult our catalog "Film Capacitors for Automotive Electronics".	5.2 "Resistance to vibration"

Topic	Safety information	Reference chapter "Mounting guidelines"
Soldering	Do not exceed the specified time or temperature limits during soldering.	1 "Soldering"
Cleaning	Use only suitable solvents for cleaning capacitors.	2 "Cleaning"
Embedding of capacitors in finished assemblies	When embedding finished circuit assemblies in plastic resins, chemical and thermal influences must be taken into account. Caution: Consult us first, if you also wish to embed other uncoated component types!	3 "Embedding of capacitors in finished assemblies"



B32651 ... B32658

High pulse (wound)

Display of ordering codes for EPCOS products

The ordering code for one and the same product can be represented differently in data sheets, data books, other publications and the website of EPCOS, or in order-related documents such as shipping notes, order confirmations and product labels. **The varying representations of the ordering codes are due to different processes employed and do not affect the specifications of the respective products.**

Detailed information can be found on the Internet under www.epcos.com/orderingcodes.



Symbols and terms

Symbol	English	German
α	Heat transfer coefficient	Wärmeübergangszahl
α_C	Temperature coefficient of capacitance	Temperaturkoeffizient der Kapazität
A	Capacitor surface area	Kondensatoroberfläche
β_C	Humidity coefficient of capacitance	Feuchtekoeffizient der Kapazität
C	Capacitance	Kapazität
C_R	Rated capacitance	Nennkapazität
ΔC	Absolute capacitance change	Absolute Kapazitätsänderung
$\Delta C/C$	Relative capacitance change (relative deviation of actual value)	Relative Kapazitätsänderung (relative Abweichung vom Ist-Wert)
$\Delta C/C_R$	Capacitance tolerance (relative deviation from rated capacitance)	Kapazitätstoleranz (relative Abweichung vom Nennwert)
dt	Time differential	Differentielle Zeit
Δt	Time interval	Zeitintervall
ΔT	Absolute temperature change (self-heating)	Absolute Temperaturänderung (Selbsterwärmung)
$\Delta \tan \delta$	Absolute change of dissipation factor	Absolute Änderung des Verlustfaktors
ΔV	Absolute voltage change	Absolute Spannungsänderung
dV/dt	Time differential of voltage function (rate of voltage rise)	Differentielle Spannungsänderung (Spannungsflankensteilheit)
$\Delta V/\Delta t$	Voltage change per time interval	Spannungsänderung pro Zeitintervall
E	Activation energy for diffusion	Aktivierungsenergie zur Diffusion
ESL	Self-inductance	Eigeninduktivität
ESR	Equivalent series resistance	Ersatz-Serienwiderstand
f	Frequency	Frequenz
f_1	Frequency limit for reducing permissible AC voltage due to thermal limits	Grenzfrequenz für thermisch bedingte Reduzierung der zulässigen Wechselspannung
f_2	Frequency limit for reducing permissible AC voltage due to current limit	Grenzfrequenz für strombedingte Reduzierung der zulässigen Wechselspannung
f_r	Resonant frequency	Resonanzfrequenz
F_D	Thermal acceleration factor for diffusion	Therm. Beschleunigungsfaktor zur Diffusion
F_T	Derating factor	Deratingfaktor
i	Current (peak)	Stromspitze
I_C	Category current (max. continuous current)	Kategoriestrom (max. Dauerstrom)



B32651 ... B32658

High pulse (wound)

Symbol	English	German
I_{RMS}	(Sinusoidal) alternating current, root-mean-square value	(Sinusförmiger) Wechselstrom
i_z	Capacitance drift	Inkonstanz der Kapazität
k_0	Pulse characteristic	Impuls Kennwert
L_S	Series inductance	Serieninduktivität
λ	Failure rate	Ausfallrate
λ_0	Constant failure rate during useful service life	Konstante Ausfallrate in der Nutzungsphase
λ_{test}	Failure rate, determined by tests	Experimentell ermittelte Ausfallrate
P_{diss}	Dissipated power	Abgegebene Verlustleistung
P_{gen}	Generated power	Erzeugte Verlustleistung
Q	Heat energy	Wärmeenergie
ρ	Density of water vapor in air	Dichte von Wasserdampf in Luft
R	Universal molar constant for gases	Allg. Molarkonstante für Gas
R	Ohmic resistance of discharge circuit	Ohmscher Widerstand des Entladekreises
R_i	Internal resistance	Innenwiderstand
R_{ins}	Insulation resistance	Isolationswiderstand
R_P	Parallel resistance	Parallelwiderstand
R_S	Series resistance	Serienwiderstand
S	severity (humidity test)	Schärfegrad (Feuchtetest)
t	Time	Zeit
T	Temperature	Temperatur
τ	Time constant	Zeitkonstante
$\tan \delta$	Dissipation factor	Verlustfaktor
$\tan \delta_D$	Dielectric component of dissipation factor	Dielektrischer Anteil des Verlustfaktors
$\tan \delta_P$	Parallel component of dissipation factor	Parallelanteil des Verlustfaktors
$\tan \delta_S$	Series component of dissipation factor	Serienanteil des Verlustfaktors
T_A	Temperature of the air surrounding the component	Temperatur der Luft, die das Bauteil umgibt
T_{max}	Upper category temperature	Obere Kategorietemperatur
T_{min}	Lower category temperature	Untere Kategorietemperatur
t_{OL}	Operating life at operating temperature and voltage	Betriebszeit bei Betriebstemperatur und -spannung
T_{op}	Operating temperature, $T_A + \Delta T$	Betriebstemperatur, $T_A + \Delta T$
T_R	Rated temperature	Nenntemperatur
T_{ref}	Reference temperature	Referenztemperatur
t_{SL}	Reference service life	Referenz-Lebensdauer



Symbol	English	German
V_{AC}	AC voltage	Wechselspannung
V_C	Category voltage	Kategorie spannung
$V_{C,RMS}$	Category AC voltage	(Sinusförmige) Kategorie-Wechselspannung
V_{CD}	Corona-discharge onset voltage	Teilentlade-Einsatzspannung
V_{ch}	Charging voltage	Ladespannung
V_{DC}	DC voltage	Gleichspannung
V_{FB}	Fly-back capacitor voltage	Spannung (Flyback)
V_i	Input voltage	Eingangsspannung
V_o	Output voltage	Ausgangsspannung
V_{op}	Operating voltage	Betriebsspannung
V_p	Peak pulse voltage	Impuls-Spitzen spannung
V_{pp}	Peak-to-peak voltage Impedance	Spannungshub
V_R	Rated voltage	Nennspannung
\hat{V}_R	Amplitude of rated AC voltage	Amplitude der Nenn-Wechselspannung
V_{RMS}	(Sinusoidal) alternating voltage, root-mean-square value	(Sinusförmige) Wechselspannung
V_{SC}	S-correction voltage	Spannung bei Anwendung "S-correction"
V_{sn}	Snubber capacitor voltage	Spannung bei Anwendung "Beschaltung"
Z	Impedance	Scheinwiderstand
e	Lead spacing	Rastermaß

Important notes

The following applies to all products named in this publication:

1. Some parts of this publication contain **statements about the suitability of our products for certain areas of application**. These statements are based on our knowledge of typical requirements that are often placed on our products in the areas of application concerned. We nevertheless expressly point out **that such statements cannot be regarded as binding statements about the suitability of our products for a particular customer application**. As a rule, EPCOS is either unfamiliar with individual customer applications or less familiar with them than the customers themselves. For these reasons, it is always ultimately incumbent on the customer to check and decide whether an EPCOS product with the properties described in the product specification is suitable for use in a particular customer application.
2. We also point out that **in individual cases, a malfunction of electronic components or failure before the end of their usual service life cannot be completely ruled out in the current state of the art, even if they are operated as specified**. In customer applications requiring a very high level of operational safety and especially in customer applications in which the malfunction or failure of an electronic component could endanger human life or health (e.g. in accident prevention or lifesaving systems), it must therefore be ensured by means of suitable design of the customer application or other action taken by the customer (e.g. installation of protective circuitry or redundancy) that no injury or damage is sustained by third parties in the event of malfunction or failure of an electronic component.
3. **The warnings, cautions and product-specific notes must be observed.**
4. In order to satisfy certain technical requirements, **some of the products described in this publication may contain substances subject to restrictions in certain jurisdictions (e.g. because they are classed as hazardous)**. Useful information on this will be found in our Material Data Sheets on the Internet (www.epcos.com/material). Should you have any more detailed questions, please contact our sales offices.
5. We constantly strive to improve our products. Consequently, **the products described in this publication may change from time to time**. The same is true of the corresponding product specifications. Please check therefore to what extent product descriptions and specifications contained in this publication are still applicable before or when you place an order. We also **reserve the right to discontinue production and delivery of products**. Consequently, we cannot guarantee that all products named in this publication will always be available. The aforementioned does not apply in the case of individual agreements deviating from the foregoing for customer-specific products.
6. Unless otherwise agreed in individual contracts, **all orders are subject to the current version of the "General Terms of Delivery for Products and Services in the Electrical Industry" published by the German Electrical and Electronics Industry Association (ZVEI)**.

Important notes

7. The trade names EPCOS, CeraDiode, CeraLink, CeraPad, CeraPlas, CSMP, CTVS, DeltaCap, DigiSiMic, ExoCore, FilterCap, FormFit, LeaXield, MiniBlue, MiniCell, MKD, MKK, MotorCap, PCC, PhaseCap, PhaseCube, PhaseMod, PhiCap, PowerHap, PQSine, PQvar, SIFERRIT, SIFI, SIKOREL, SilverCap, SIMDAD, SiMic, SIMID, SineFormer, SIOV, ThermoFuse, WindCap are **trademarks registered or pending** in Europe and in other countries. Further information will be found on the Internet at www.epcos.com/trademarks.

X-ON Electronics

Largest Supplier of Electrical and Electronic Components

Click to view similar products for [Film Capacitors](#) category:

Click to view products by [EPCOS](#) manufacturer:

Other Similar products are found below :

[F339X134748MIP2T0](#) [F450KG153J250ALH0J](#) [750-1018](#) [FKP1-1500160010P15](#) [FKP1R031007D00JYSD](#) [FKP1R031507E00JYSD](#)
[FKP1U024707E00KYSD](#) [82DC4100CK60J](#) [82EC1100DQ50K](#) [PFR5101J100J11L16.5TA18](#) [PME261JB5220KR19T0](#) [A451GK223M040A](#)
[A561ED221M450A](#) [QXJ2E474KTPT](#) [QXL2B333KTPT](#) [R49AN347000A1K](#) [EEC2G505HQA406](#) [B25668A6676A375](#) [B25673A4282E140](#)
[BFC233868148](#) [BFC2370GC222](#) [C3B2AD44400B20K](#) [C4ASWBU3220A3EK](#) [CB027C0473J--](#) [CB177I0184J--](#) [CB182K0184J--](#) [23PW210](#)
[950CQW5H-F](#) [SBDC3470AA10J](#) [SCD105K122A3-22](#) [2N3155](#) [A571EH331M450A](#) [FKP1-2202KV5P15](#) [FKS3-680040010P10](#)
[QXL2E473KTPT](#) [445450-1](#) [B25669A3996J375](#) [46KI322000M1M](#) [46KR415050M1K](#) [4BSNBX4100ZBFJ](#) [MKP383510063JKP2T0](#)
[MKPY2-.02230020P15](#) [MKT 1813-368-015](#) [4055292001](#) [46KN410000N1K](#) [EEC2E106HQA405](#) [EEC2G205HQA402](#) [EEC2G805HQA415](#)
[P409CP224M250AH470](#) [82EC2150DQ50K](#)