

ENERGIZER NO. L91

Specifications

AA



Industry Standard Dimensions

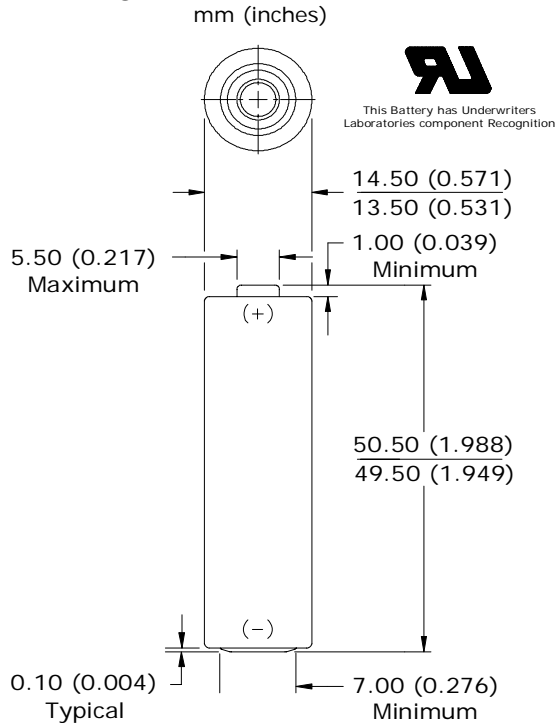

- Classification:** "Cylindrical Lithium"
Chemical System: Lithium/Iron Disulfide (Li/FeS₂)
Designation: ANSI 15-LF, IEC-FR6
Nominal Voltage: 1.5 Volts
Storage Temp: -40°C to 60°C (-40°F to 140°F)
Operating Temp: -40°C to 60°C (-40°F to 140°F)
Typical Capacity: 3000 mAh* (to 1.0 volts)
Capacity Test: 200 mA continuous drain (21°C)
 * Varies according to the applied load, temperature, and cutoff voltage.
Typical Weight: 14.5 grams (0.5 oz.)
Typical Volume: 8.0 cubic centimeters (0.5 cubic inch)
Max Discharge: 2.0 Amps Continuous
 3.0 Amps Pulse (2 sec on/8 sec off)
Typical Li Content: 0.98 grams (0.03 oz.)
UL Listed: MH29980
Shelf Life: 15 years at 21°C (90% of rated capacity)
Shipping: For complete details, please reference:
 Global (except US): Special Provision A45 of the International Air Transport Association Dangerous Goods Regulations
 United States: 49 CFR 173.185

Storage/Capacity Characteristics

Effects of Storage at Various Temperatures

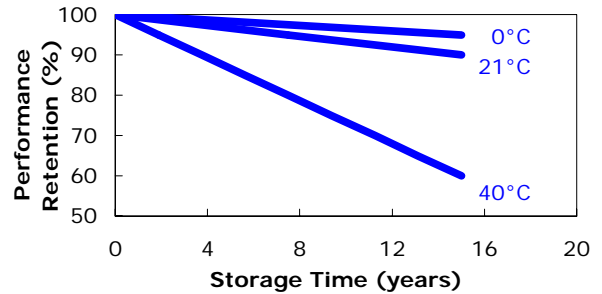

Constant Power Performance

Typical Characteristics to 1.0 Volts (21°C)

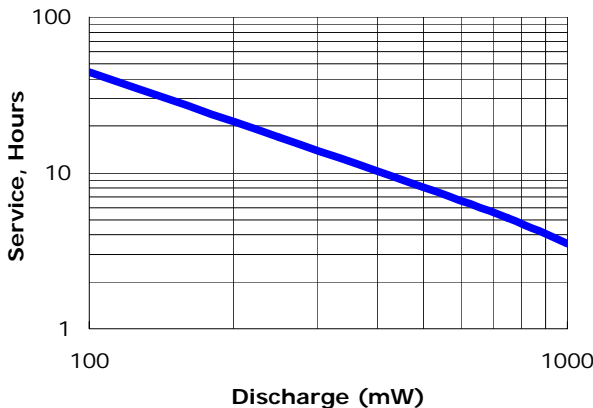

Constant Current Performance

Typical Characteristics to 0.9 Volts (21°C)

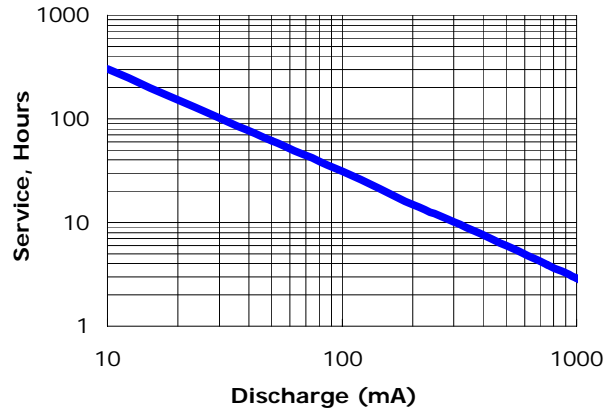

Important Notice

This data sheet contains typical information specific to batteries manufactured at the time of its publication.

Contents herein do not constitute a warranty.

©Energizer - All Rights Reserved

ENERGIZER NO. L91

Constant Power Performance

Typical Discharge Characteristics (21°C)

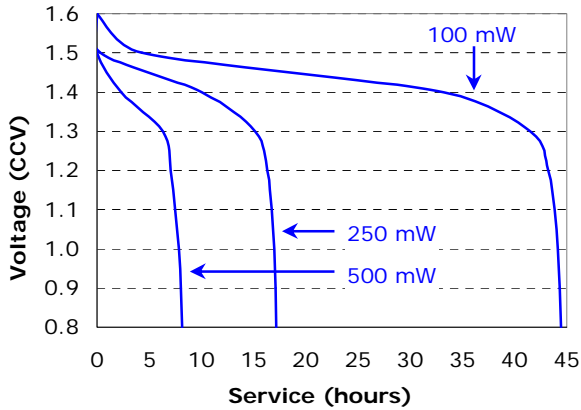

Constant Current Performance

Typical Discharge Characteristics (21°C / 0°C / -20°C)

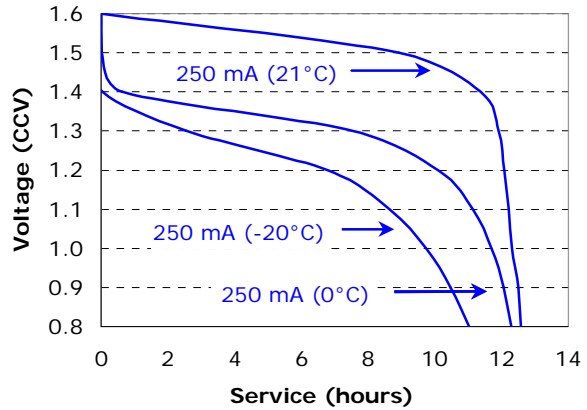

Industry Standard Tests (21°C)

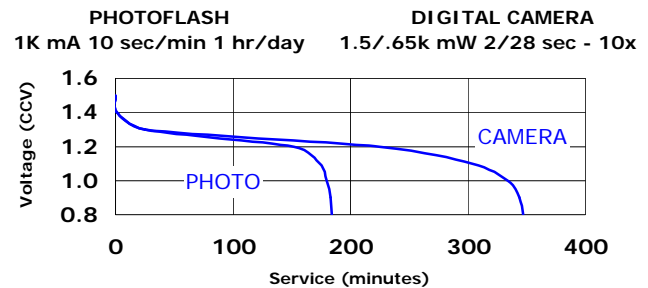
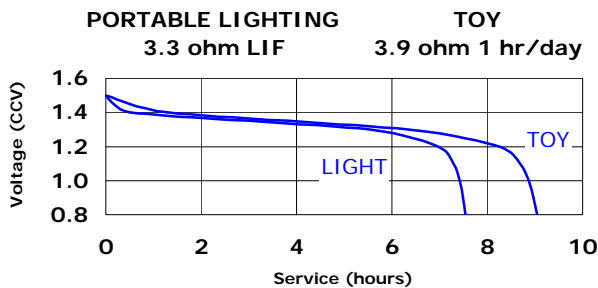
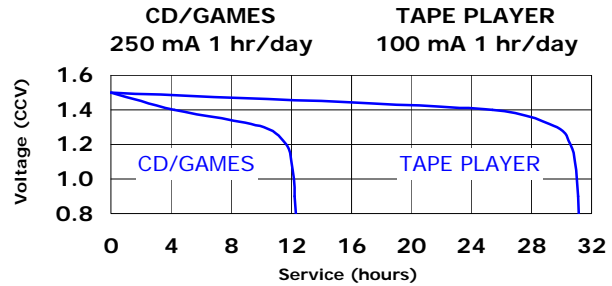
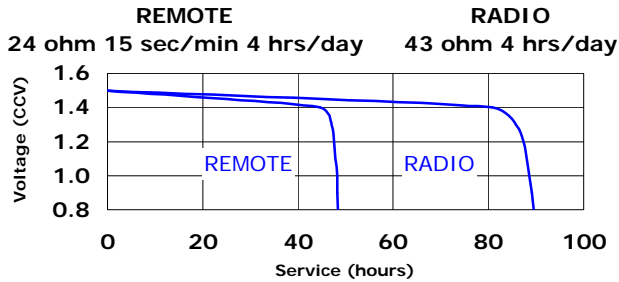

Important Notice

This data sheet contains typical information specific to batteries manufactured at the time of its publication.

Contents herein do not constitute a warranty.

©Energizer - All Rights Reserved

X-ON Electronics

Largest Supplier of Electrical and Electronic Components

Click to view similar products for [energizer manufacturer](#):

Other Similar products are found below :

[1215F2X3](#) [E11A B2](#) [LR43 186](#) [AC13](#) [AC675](#) [3LR12](#) [603298](#) [625302](#) [625304](#) [638006](#) [639830](#) [S9025](#) [7638900426687](#) [7638900414660](#)
[E92 MAX](#) [E91 MAX](#) [HARD CASE RECHARGEABLE](#) [HARD CASE PRO MULTI USE](#) [HCHD311](#) [S9029](#) [639826](#) [603386](#) [HARD CASE](#)
[PROFF 4AA](#) [HARDCASE PRO HEADLIGHT](#) [639618](#) [RCLINM2WR](#) [S8865](#) [S8707](#) [S8100](#) [7638900424478](#) [7638900313130](#) [626177](#)
[E300116200](#) [639838](#) [HARDCASE PRO WORK LIGHT](#) [603305](#) [E300280600](#) [METAL LED 6AA](#) [S8864](#) [HDD32E](#) [MS2AALED](#)
[ENERGIZERÂ® 2-IN-1 LANTERN HANDHELD](#) [E300124200](#) [E300171700](#) [ENFFL81E](#) [E300112600](#) [633474](#) [HDA32E](#) [7638900421422](#)
[HARD CASE PRO PIVOT](#)