

## ENERGIZER NO. X95

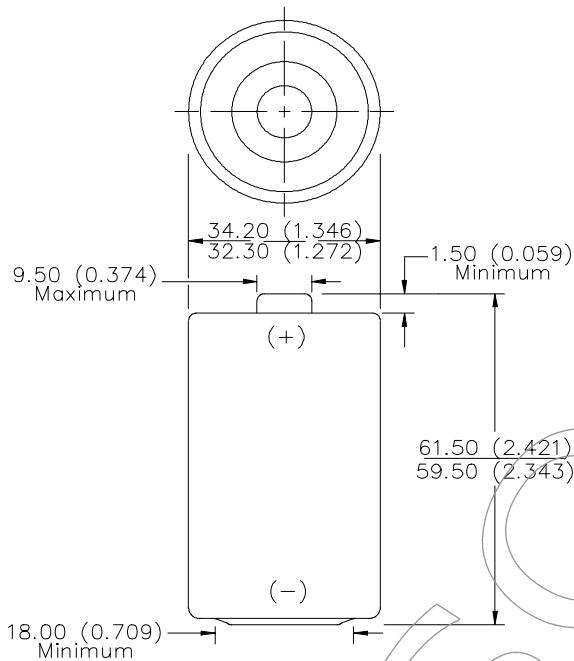

Industry Standard Dimensions in mm (inches)



**D**

**Chemical System:** Alkaline  
 Zinc-Manganese Dioxide (Zn/MnO<sub>2</sub>)  
 (No Added Mercury or Cadmium)

**Designation:** ANSI-13A, IEC-LR20

**Battery Voltage:** 1.5 Volts

**Internal Resistance:** 173 Milliohms (Fresh)

**Operating Temp:** -18°C to 55°C (0°F to 130°F)

**Average Capacity:** 21,500 mAh (to 0.8 volts)  
 (Rated capacity at 25 mA continuous drain)

**Average Weight:** 148.0 grams (5.2 oz.)

**Volume:** 55.9 cubic centimeters (3.4 cubic inch)

**Cell:** One No. X3-350 (size 'D')

**Jacket:** Plastic Label

**Shelf Life:** 7 years (80% of rated capacity)

### TEMPERATURE EFFECTS Typical Service to 0.8 Volts

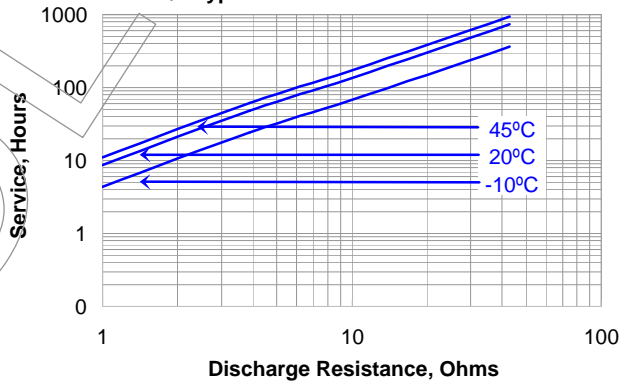

### CONSTANT RESISTANCE PERFORMANCE Typical Service

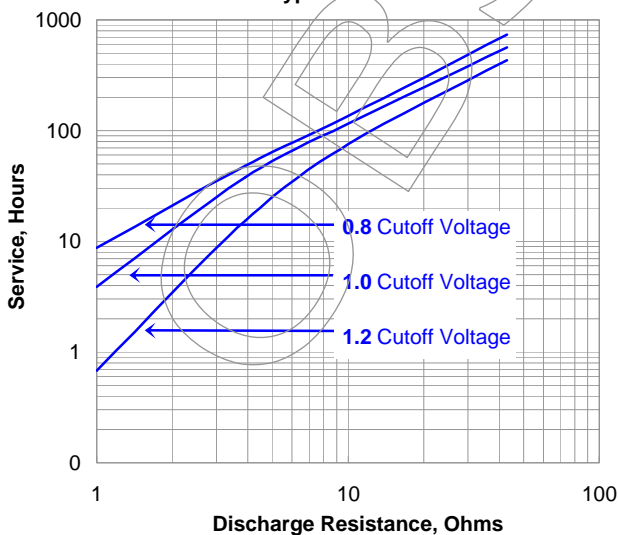

### CONSTANT CURRENT DISCHARGE Typical Service

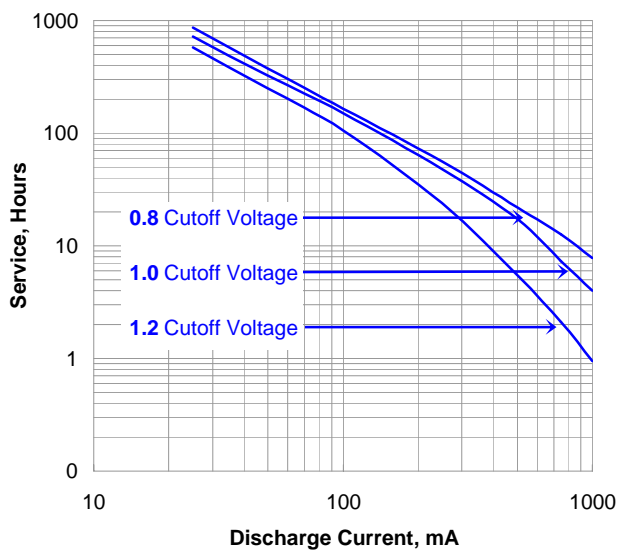

### Important Notice

This data sheet contains information specific to batteries manufactured at the time of its publication.

**Contents herein do not constitute a warranty.**

Copyright © Eveready Battery Co. - All rights reserved

## ENERGIZER NO. X95

### Industry Standard Tests @ 20° C

PORTABLE LIGHTING  
1.5 ohm - HIF

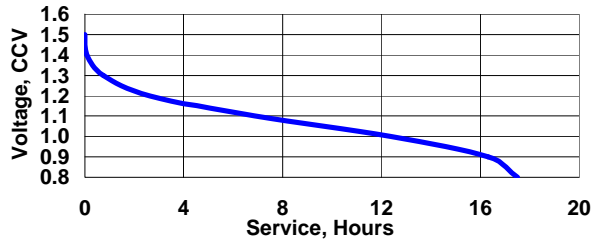

TOY  
2.2 ohm - 1hr/day

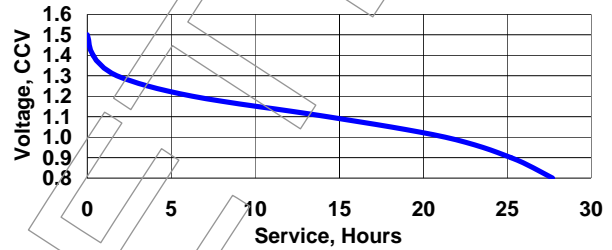

PORTABLE STEREO  
600 mA - 2 hr/day

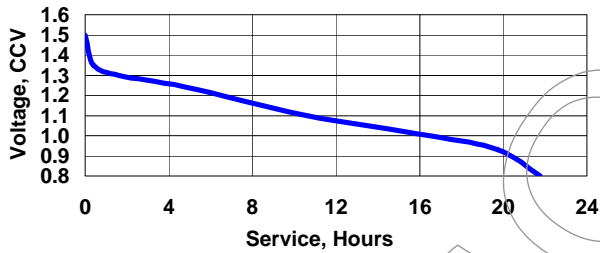

PORTABLE LIGHTING  
2.2 ohm - LIF

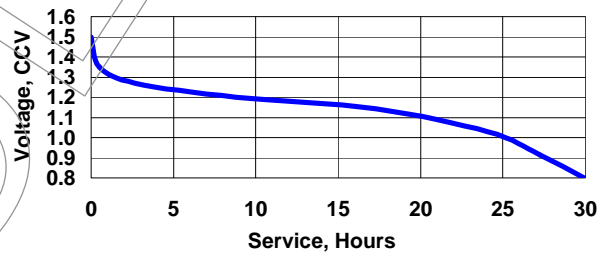

RADIO  
10 ohm - 4 hr/day

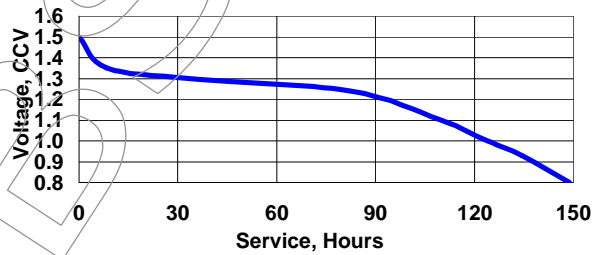

### Important Notice

This data sheet contains information specific to batteries manufactured at the time of its publication.

**Contents herein do not constitute a warranty.**

Copyright © Eveready Battery Co. - All rights reserved

## X-ON Electronics

Largest Supplier of Electrical and Electronic Components

*Click to view similar products for [energizer manufacturer](#):*

Other Similar products are found below :

[1215F2X3](#) [E11A B2](#) [LR43 186](#) [AC13](#) [AC675](#) [3LR12](#) [603298](#) [625302](#) [625304](#) [638006](#) [639830](#) [S9025](#) [7638900426687](#) [7638900414660](#)  
[E92 MAX](#) [E91 MAX](#) [HARD CASE RECHARGEABLE](#) [HARD CASE PRO MULTI USE](#) [HCHD311](#) [S9029](#) [639826](#) [603386](#) [HARD CASE](#)  
[PROFF 4AA](#) [HARDCASE PRO HEADLIGHT](#) [639618](#) [RCLINM2WR](#) [S8865](#) [S8707](#) [S8100](#) [7638900424478](#) [7638900313130](#) [626177](#)  
[E300116200](#) [639838](#) [HARDCASE PRO WORK LIGHT](#) [603305](#) [E300280600](#) [METAL LED 6AA](#) [S8864](#) [HDD32E](#) [MS2AALED](#)  
[ENERGIZERÂ® 2-IN-1 LANTERN HANDHELD](#) [E300124200](#) [E300171700](#) [ENFFL81E](#) [E300112600](#) [633474](#) [HDA32E](#) [7638900421422](#)  
[HARD CASE PRO PIVOT](#)