

62 GB- Series Plugs

Miniature Bayonet Lock Connectors
Complies with MIL-C-26482

CE-2Pa

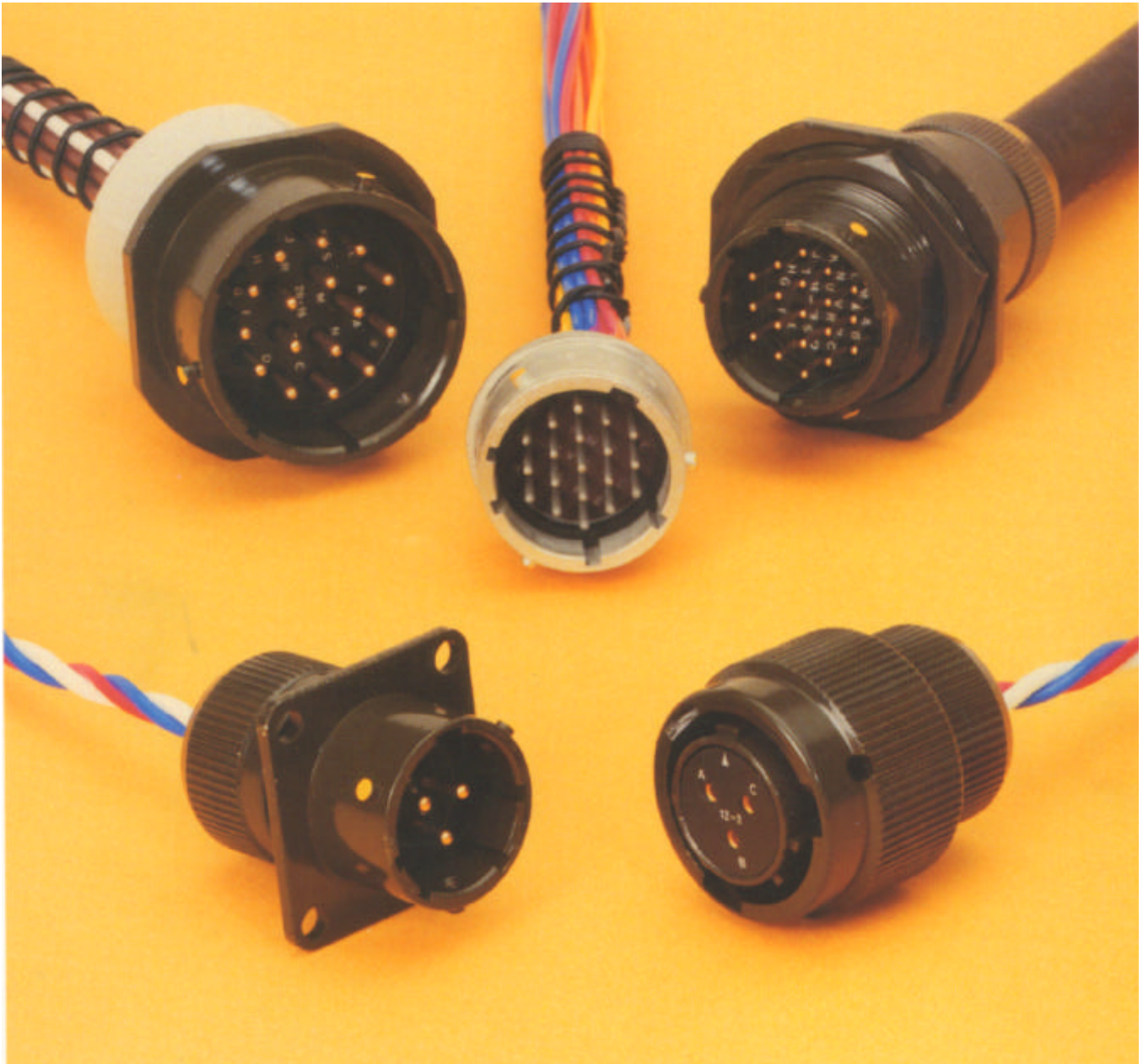

This miniature bayonet lock connector series offers designers important features not found in any other range of connectors.

They are developed and manufactured entirely in the U.K. by AMPHENOL Ltd., and have full qualification approval to British Standards Specification BS 9522 F0017 and British Defence Specification DEF STAN 59-35 (Part 3) Sec. 7.

This catalogue to be used in conjunction with Catalogues:
CE-2Ra – 62GB Series Receptacles
CE-2Aa – 62GB Series Accessories

Amphenol

62GB and Pattern 608 New Planforms

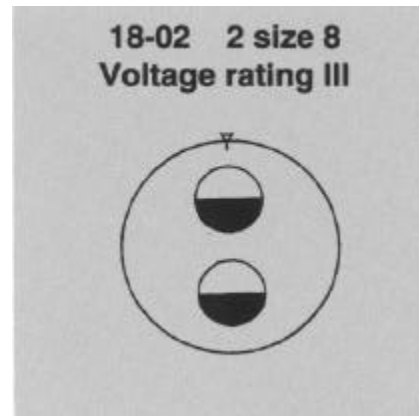
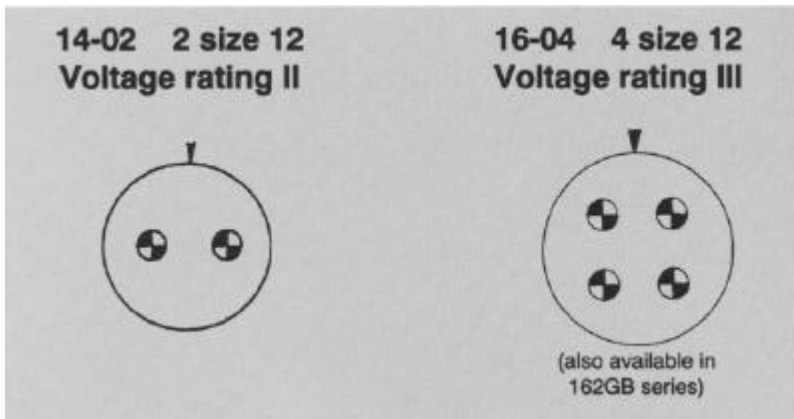

Current:

- (a) Maximum current per individual contact (in isolation)* at ambient temperature of 85°C
Contact size 12: 23 A
- (b) Maximum current per contact through all contacts simultaneously at an ambient temperature of 85°C
Contact size 12: 20 A

Current:

- (a) Maximum current per individual contact (in isolation)* at ambient temperature of 85°C
Contact size 8: 45 A
- (b) Maximum current per contact through all contacts simultaneously at an ambient temperature of 85°C
Contact size 8: 40 A

	Sea level 1013 mbar á			8500m (27,900ft) 320 mbar			21,340m (70,000ft) 44 mbar		
	I	II	III	I	II	III	I	II	III
Voltage rating Working voltages ** (nominal)	700	1200	1500	550	650	800	330	380	450
d.c. or a.c. peak Voltage proof d.c. or a.c. peak	2100	3000	3000	1100	1300	1300	660	760	750

* i.e. when only one contact per connector is electrically loaded.

á 1 mbar=10² N/m²=100 Pa

** Establishment of electrical safety factors is the responsibility of the user

CONTENTS

Page

Amphenol 62GB Solder Connectors	4
Schedule of Tests	5-6
Connector Styles Available	7
Insert Availability	8
Ordering 62GB Series Connectors	10-11
Plugs - Table of Styles	12-13
Plugs	14-19
Insert Orientations	20
Key/Keyway Orientations	21

Amphenol® 62GB solder connectors

This catalogue to be used in conjunction with Catalogues:
CE-2Ra – 62GB Series Receptacles
CE-2Aa – 62GB Series Accessories

This miniature bayonet lock connector series offers designers important features not found in any other range of connectors. The range has full qualification approval to British Standards Specification BS 9522 FOO 17 and British Defence Specification DEF STAN 59-35 (Part 3) Sec. 7.

62GB Series connectors - developed and manufactured entirely in the United Kingdom by Amphenol Limited. They are the first and only British connectors to have achieved this. A doubly strong position which Amphenol are well geared to handle. The manufacturing facilities of the Whitstable plant have been cited as exemplary in Europe. Certainly the layout is extensive and extremely efficient; safety awards have been attained every time returns have been submitted to the British Safety Council.

62GB Series connectors have been well established with Government authorities on an international scale and users can be found in Sweden, Denmark, Norway, Finland, Germany, Spain, Holland, India, Canada and Italy.

Derating

Connectors must be derated under the following operating conditions:

1. At elevated ambient temperatures, the current ratings are reduced so that total maximum hot spot temperature of 125°C is not exceeded.
2. At high altitudes, revised voltage ratings become effective as shown on page 7.
3. When connectors to different specifications are intermated (e.g. BS 9522 FOO 17 and MIL-C26482), the combination must not be operated under conditions more severe than the less stringent clause of either specification.

Amphenol 62GB connectors are designed to meet the most stringent requirements of both specifications.

Military Specifications

British Standards Specification BS 9522 FOO 17 closely corresponds to the United States Military Specification MIL-C-26482 solder terminations. Certain differences exist between the schedules which can be seen on pages 2 and 3.

Approved gauges are used to check interchangeability of 62GB series with other connectors manufactured to BS 9522 FOO 17 or MIL-C-26482.

Basic Construction

Connector shells are machined from solid aluminium bar stock - not forged or extruded as in competitive designs. Machining has inherent advantages in terms of strength and adaptability. 62GB Series can be supplied in brass or stainless steel, for instance.

The normal shell finish used, which has a high resistance to corrosion, is zinc cobalt olive drab. Other finishes may be supplied to special order, such as cadmium plate which is available by adding deviation (714) to the end of part number.

Inserts are of polychloroprene rubber compounded to an Amphenol specification. Operating temperature range is -55°C to 125°C, and the connectors have gold-plated contacts designed for soldered connections. Configurations for size 20 contacts range between 2 contacts in the size 8 12.7mm (0.5in diameter) shell up to a maximum of 61 contacts in the size 2436.1 mm (1.5in diameter) shell. Intermediate sizes, and contact data for heavier current ratings are shown in the insert availability chart on page 6 and 7.

Hermetic connectors with glass sealed dielectric are manufactured with mild steel shells and nickel iron contacts plated tin over copper.

* Other finishes are available on request.

Protection Against Mis-Mating or Cross-Plugging

In BS 9522 FOO 17 positive shell-to-shell keying is provided with keys and keyways in a choice of either the normal (N) or any of the four preferred alternate positions: B, C, E and F. This prevents mismating between shells of different orientations and overcomes the difficulties associated with rotated inserts and a standard key-keyway orientation. In the latter system, damage to the inserts or contacts can result if excessive force is used to engage non-mating pairs.

Rotated inserts are, however, permissible in BS 9522 FOO 17 connectors if required to mate with or replace units to MIL-C-26482 mounted in existing equipment. Connectors have normal orientations manufactured to BS 9522 FOO 17 or MIL-C-26482 are fully intermateable as also are connectors with inserts in positions W, X, Y or Z.

Schedule of Tests Required for Qualification Approval

Tests	Brief Description
Visual Examination	
Dimensions, outline mass(including contacts) Compatability Gauging procedure	
Polarization	
Engaging and separating force, connector	Engagement max: 0,90 Nm (8.0 lbf.in.) to 4,97 Nm (44 lbf.in.) according to shell size. Separation min: 0,22 Nm (2.0 lbf.in.) to 1,58 Nm (14.0 lbf.in.) according to shell size.
Contact Holding Force	0,21 N (0.047 lbf) min.size 20 0,56 N (0.126 lbf)min. size 16
Sealing (air pressure)	Max leakage 28,53 uNm/s (1 cm3/h), 1 bar (14.5 p.s.i.) differential.
Sealing Hermetic	Hermetic receptacles have a max leak of 0.1 micron cubic foot per hour (1 x 10-6Cm3/s)
Contact Resistance	5 milliohms max.
Housing (Shell) Continuity	200 milliohms max. 5 milliohms max. grounding spring styles.
Insulation Resistance	5,000 Megaohms at 500 - 50 V d.c.
Voltage Proof	See page 7. Duration 1 minute
Soldering	As BS 9520: 1974, Clause 1.2.6.6, Method 2.
Bumping	As BS 9520: 1974, Clause 1.2.6.1. 4,000 -10 bumps / 390m / s2 (40 gn).
Vibration	As BS 9520: 1974, Clause 1.2.6.2.1. Procedure A. 10 Hz to 5000 Hz, 0.75 mm / 10 gn.
Shock	As BS 9520: 1974, Clause 1.2.6.3. 981 m/s2 (100 g n).
Acceleration (Steady State)	As BS 9520: 1974, Clause 1.2.6.4. 490 m/s2 (50 gn).
Rapid Change of Temperature	As BS 9520: 1974, Clause 1.2.6.7. -550 C to - 1250 C.
Climatic Sequence	As BS 9520: 1974, Clause 1.2.6.11. Severity 55/125/56.
Flammability	As BS 9520: 1974, Clause 1.2.6.8. Direct flame applied, duration 1 minute.
Damp Heat (Steady State)	As BS 9520: 1974, Clause 1.2.6.14. Severity 56 days.

Schedule of Tests Required for Qualification Approval

Tests	Brief Description
Immersion (at low air pressure)	3 cycles at 30 mins each cycle, total immersion in water at pressure 44 m bar.
Mechanical Endurance	500 operations minimum
High Temperature Endurance	Long term: 1,000 hrs. at 850 C ambient carrying the specified current. Short term: 250 hrs at 1250 C, no current.
Mould Growth	As BS 9520: 1974, Clause 1.2.6.15. 28 days duration.
Salt Mist	As BS 9520: 1974, Clause 1.2.6.16. Severity 1.
Dust	As BS 9520: 1974, Clause 1.2.6.17. Exposure 30 minutes.
Robustness of Terminations	44,5 N (101bf) size 16 22,2 N (5 lbf) size 20
Contact Retention (in insert)	67,0 N (15 lbf) min. size 20 112,0 N (25 lbf) min. size 16
Insert Retention (in shell)	517 KN1m2 (751bf/in2) min.
Test Prod Damage	Moment: 0,056 Nm (0.5 lbf in) size 20 0,225 Nm (2 lbf in) size 16
Impact	Five impacts, drop height 1 m (3ft.3 in.).
Grounding Spring Holding Force Plugs with grounding springs only.	1,17 N (0.263 lbf) to 2,74 N (0.616 lbf) according to size.
Fluid Resistance	Immersion in 4 solvents and 9 fluids including aircraft fuels, lubricating oils and hydraulic fluids.
Compass Safe Distance	As BS 9520: 1974, Clause 1.2.5.11. 127 mm (5.0 in) min.

Connector Styles Available

Plugs

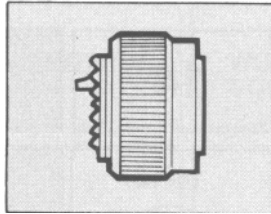

Straight Plug
See Pages 14-17

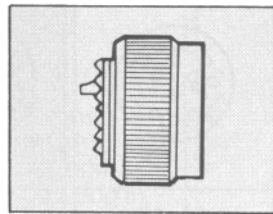

Grounded Plug
See Page 14

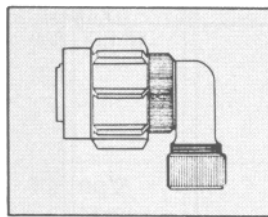

Audio Plug
See Page 18

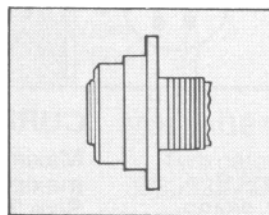





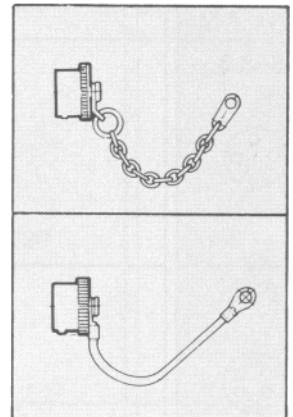















Push on - Pull off
See Page 19

Accessories
See Catalogue CE-2Aa



Insert Availability

8	10	12	14	16	18	20
8-2* 	10-6 	12-10 	14-12† 	16-23* 	18-32 	20-41 
8-3* 	10-7 		14-15 	16-26 		
8-3 3 			14-19 			
8-4* 						
8-98 	10-2 	12-3 	14-5 	16-8 	18-11 	20-16 

NOTES

* This insert arrangement is not included in B.S. spec., but is available and listed in MIL-C-26482.

† Due to the arrangement of contacts in the 14-12 insert arrangement it is classified, for current derating, in the shell size range 18-24.

Lettering of inserts shown above corresponds to view of front (mating surface of pin inserts or rear face (cable accessory end) of socket inserts.

KEY ● No 16 size contacts
○ No 20 size contacts

CURRENT RATING

Maximum current per individual contact (in isolation) at a maximum ambient temperature of 85°C: Size 20 contact 7.5A Size 16 contact 13-OA The performance of 62GB Series connectors at all times exceeds the maximum continuous bunched rating of the appropriate size wire, or cable of equivalent temperature rating. This bunched rating is therefore the determining factor. In the case of mixed loadings, the greatest individual load shall be the bunched loading. In any combination of ambient temperature plus temperature rise due to current flow through the contacts, the maximum connector internal hot spot temperature of 125°C must not be exceeded.

That is, when only one contact per connector is loaded.

Insert Availability

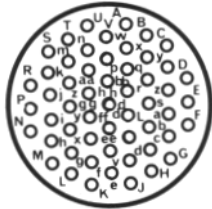
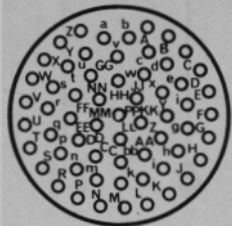
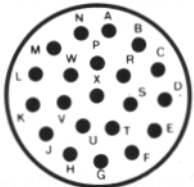
		VOLTAGE RATINGS			
22	24	ALTITUDE	D.C. WORKING VOLTAGE	A.C. WORKING VOLTAGE R.M.S.	PROOF VOLTAGE D.C. OR A.C. PEAK
<p>22-55</p> 	<p>24-61</p> 	<p>Rating 1 Sea level</p> <p>300 mb at 20°C 8,500m (27,800 ft)</p> <p>44 mb at 20°C 20,000m (66,000 ft)</p>	700	500	2100
<p>22-21</p>  <p>† Available to special order only</p>		<p>Rating 2 Sea level 300 mb at 20°C 8,500m (27,800 ft) 44 mb at 20°C 20,000m (66,000 ft)</p>	120	850	3000
			650	460	1300
			380	270	760

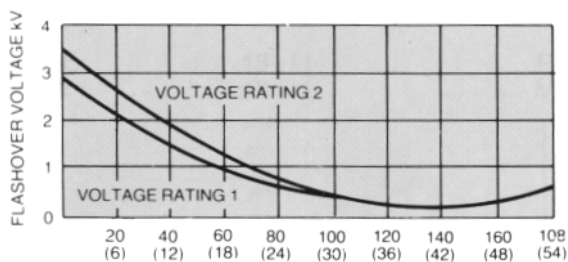

ALTITUDE-THOUSANDS OF FEET (METRES)
Relationship between flashover voltage and altitude for each voltage rating

VOLTAGE RATINGS

Two categories of voltage rating are specified in BS9522 F0017, F0038 and N0001.

Rating 1 (700V d.c. working at sea-level) Applicable to the high contact density inserts shown in the upper section of the insert availability diagram above.

Rating 2 (1200V d.c. working at sea-level) Applicable to the inserts shown in the lower section of the insert availability diagram.

Altitude derating. Information on voltage derating for operation at altitudes above sea-level can be obtained from the flashover voltage altitude curves on the left.

Ordering 62GB Series Connectors

To obtain the specific connector required write down the connector number from the typical example below. Only inserts shown in the availability chart on p. 10&11 can be specified. All connectors are delivered with protective dust covers

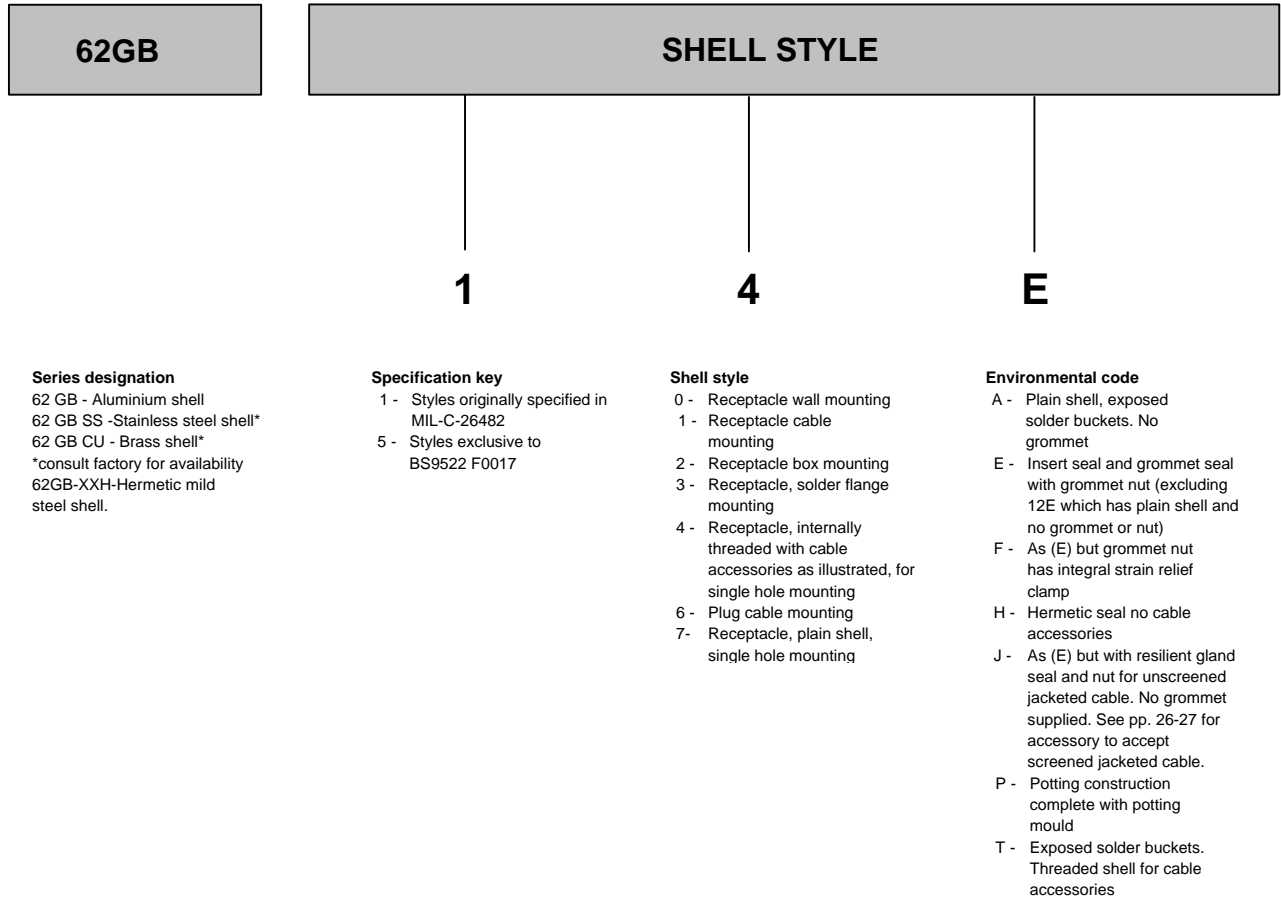

HOW TO ORDER FROM MS CONNECTOR NUMBERS

Connector numbers in the AMPHENOL and MS numbering systems. Only alternative insert orientations are specified in MIL-C-26482 which does not include alternative key/keyway orientations.

MS31	-	14	E	18 -11	P	X
62GB	-	14	E	18 -11	P	X

Ordering 62GB Series Connectors

INSERT ARRANGEMENT

18

11

P

B

(044)

Shell size (in sixteenths of an inch) 8, 10, 12, 14, 16
18,20,22,24

Number of contacts
2, 3, 4, 5, 6, 7, 8, 10, 11, 12,
16, 19, 21, 23, 26, 32, 41, 55,
61
* consult factory for availability

Contact Style
P - Pins
S - Sockets For hermetic connectors. P3 denotes pin contacts with solder bucket terminations. (Standard range). P2 denotes pin contacts with flattened and pierced terminations. (Special order).

Orientation
(Omit if normal orientation)
Keys/Keyways: A', B, C, D', E, F, (see p. 31)
Inserts: W,X,Y,Z.(see p56/57)
*Inactive for new designs

Deviations
(044) Rough grip heavy duty coupling ring.
(046) Box mounting plug.
(214) Fitted with extension back shell and strain relief clamp without grommet on F types only
(218) Lever coupling ring
(219) Contacts for flexible punted wrung (57A and 12E only)
(639) Bright cadmium plated shells
(345) Contacts for flexible punted wiring 12H,13H 17H only
(276) Hermetics with gold plated contacts.
(608) Black anodise.
(416) Electroless nickel
(714) Cadmium plate olive drab

HOW TO ORDER FROM B.S. CONNECTOR NUMBERS

Select the connector style by reference to BS9522 F0017 using the code below for identification. Note that the B.S. Specification includes only certain connectors from the table of styles as shown on pp. 8 & 9. Alternative key/keyway orientations are preferred in the BS9522 F0017 Specification to prevent mis-mating. However, rotated inserts are permissible where connectors are required to mate with or replace items to MIL-C-26482 on existing equipment.

62GB - 14E
C2098

18-11
18 11

P
M

B
B

O

Style

Insert Arrangement, see above

M - Pin contacts
F - Socket contacts



Alternative Key/Key way Orientation

Variant.
O - Standard connector

Plugs

Table of Styles

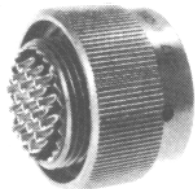
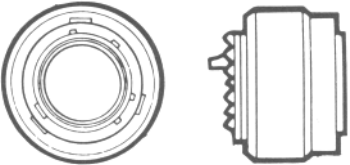
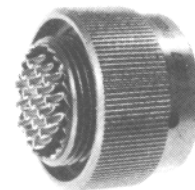
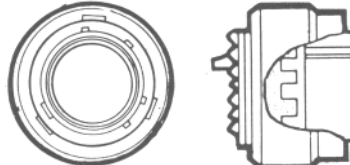
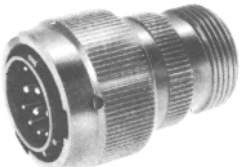
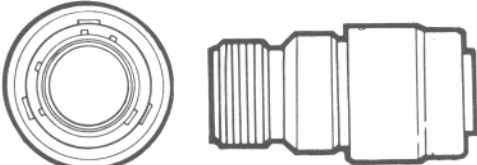
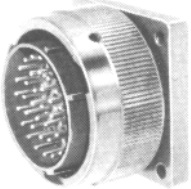
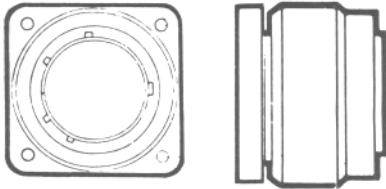
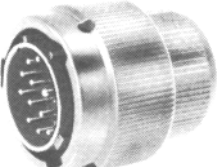
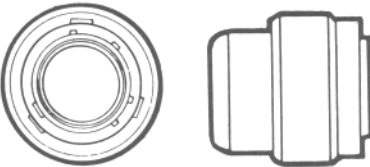
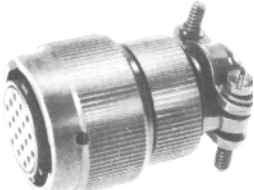
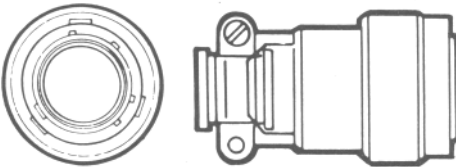
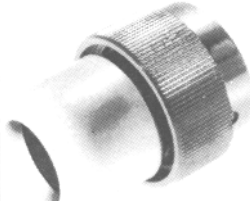

Page No.

62GB-56T			14
62GB-56TG			14
62GB-16A			15
62GB-56T (046)			15
62GB-16E			16
62GB-16F			16
62GB-16P			17

Plugs

Table of Styles

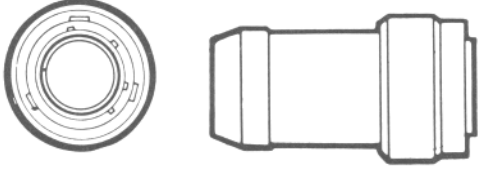
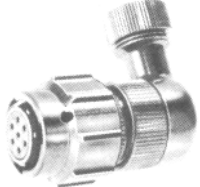
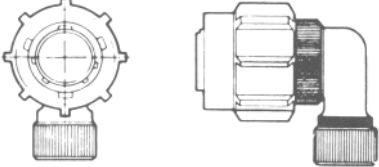
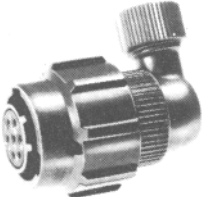
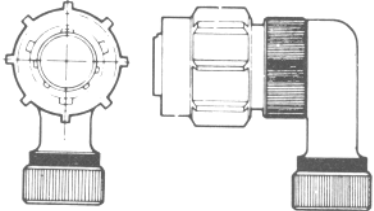
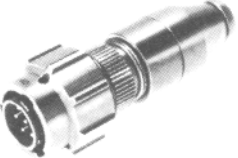
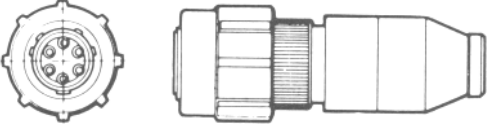
Page No.

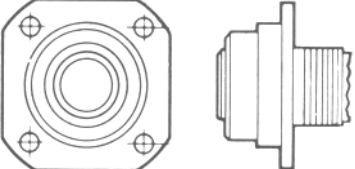
62GB-16J			17
62GB-5039-10			18
62GB-5055-10			18
62GB-5056-10			18
62GB-5074			19

Plugs

56T

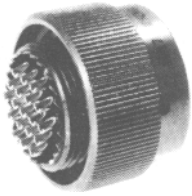

62GB-56T
BS9522 F0017 C2092

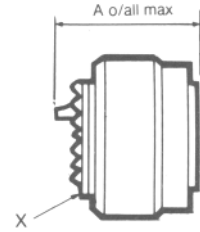
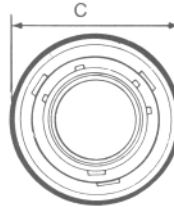

Basic plug with threaded shell to accept standard cable accessories

Shell Size	A Max	C max	X Thread
08	0.976	0.750	7/16 - 28 UNEF
	24.79	19.05	
10	0.976	0.859	9/16 - 24 NEF
	24.79	21.82	
12	0.976	1.031	11/16 - 24NEF
	24.79	26.19	
14	0.976	1.156	13/16 - 20 UNEF
	24.79	29.36	
16	0.976	1.281	15/16 - 20 UNEF
	24.79	32.54	
18	0.976	1.391	1.1 /16 - 18 NEF
	24.79	35.33	
20	0.976	1.531	1.3/16 - 18 NEF
	24.79	38.89	
22	0.976	1.656	1.5/16 - 18 NEF
	24.79	42.06	
24	0.976	1.777	1.7/16 - 18 NEF
	24.79	45.14	

56TG

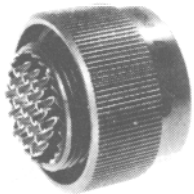

62GB-56TG
BS9522 F0017 C2093

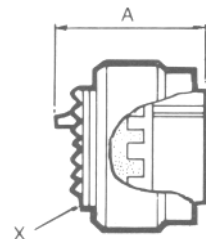
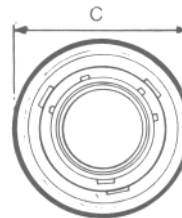

Basic plug with threaded shell to accept standard cable accessories. Has shell grounding spring fingers

Shell Size	A max	C max	X Thread
08	0.976	0.750	7/16 - 28 UNEF
	24.79	19.05	
10	0.976	0.859	9/16 - 24 NEF
	24.79	21.82	
12	0.976	1.031	11/16 - 24 NEF
	24.79	26.19	
14	0.976	1.156	13/16 - 20 UNEF
	24.79	29.36	
16	0.976	1.281	15/16 - 20 UNEF
	24.79	32.54	
18	0.976	1.391	1.1 /16 - 18 NEF
	24.79	35.33	
20	0.976	1.531	1.3/16 - 18 NEF
	24.79	38.89	
22	0.976	1.656	1.5/16 - 18 NEF
	24.79	42.06	
24	0.976	1.777	11/16 - 18 NEF
	24.79	45.14	

Plugs

16A



62GB-1 6A

Plug with general duty back shell.
No grommet provided.

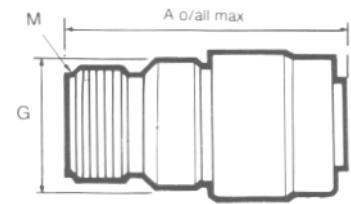

Shell Size	A max	C max	G max	M Thread
08	1.614	0.750	0.561	1/2 - 28 UNEF
	41.00	19.05	14.25	
10	1.614	0.859	0.686	5/8 - 24 NEF
	41.00	21.82	17.43	
12	1.614	1.031	0.811	3/4 - 20 UNEF
	41.00	26.19	20.60	
14	1.614	1.156	0.936	7/8 - 20 UNEF
	41.00	29.36	23.78	
16	1.614	1.281	1.061	1 - 20 UNEF
	41.00	32.54	26.95	
18	1.614	1.391	1.186	1.3/16 - 18 NEF
	41.00	35.33	30.13	
20	1.614	1.531	1.311	1.3/16 - 18 NEF
	41.00	38-89	33.30	
22	1.614	1.656	1.436	1.7/16 - 18 NEF
	41.00	42.06	36.75	
24	1.658	1.777	1.561	1.7116 - 18 NEF
	42.11	45.14	39.65	

56T



62GB-56T(046)

Box-mounting plug. Available for shell size 16:
other sizes to special order. Cable accessories
cannot be fitted.

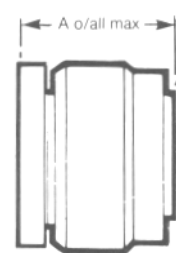
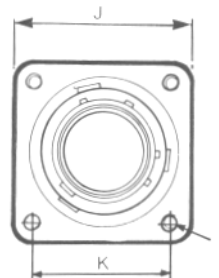

Shell Size	A max	J max	K	L
16	1.042	1.317	1.000	6.32 NC
	26.47	33.45	25.40	
20	1.042	1.625	1.250	6.32 NC
	26.47	41.28	31.75	
22	1.042	1.625	1.250	6.32 NC
	26.47	41.28	31.75	

Plugs

16E

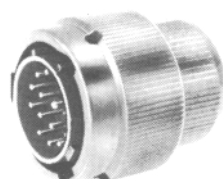

62GB-16E

MIL - C26482 MS3116E

Plug with grommet and grommet nut

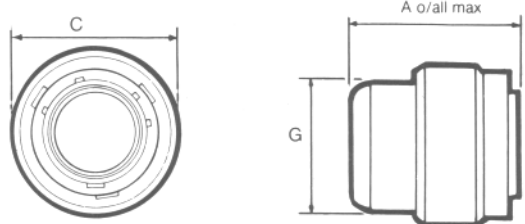

Shell Size	A max	C max	G max
08	1.281	0.750	0.561
	32.54	1.05	14.25
10	1.281	0.859	0.686
	32.54	21.82	17.431
12	1.281	1.031	0.811
	32.54	26.19	20.60
14	1.281	1.156	0.936 l
	32.54	29.36	23.78
16	1.281	1.281	1.061
	32.54	32.54	26.95
18	1.281	1.391	1.186
	32.54	35.33	30.13
20	1.281	1.531	1.311
	32.54	38.89	33.30
22	1.281	1.656	1.436
	32.54	42.06	36.75
24	1.281	1.777	1.561
	32.54	45.14	39.65

16F



62GB-16F

MIL - C26482 MS3116F

Plug with grommet and grommet nut fitted with integral strain relief clamp.

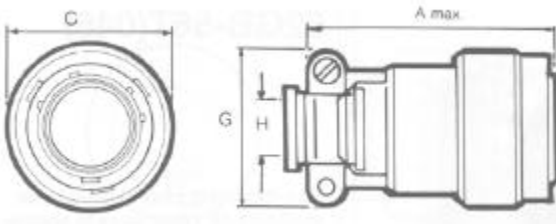

Shell Size	A max	C dia max	G dia max	H ± 0.005 (± 0.13)
08	1.752	0.750	0.828	0.156
	44.50	19.05	21.03	3.96
10	1.752	0.859	0.891	0.188
	44.50	21.82	22.63	4.78
12	1.752	1.031	1.016	0.312
	44.50	26.19	25.81	7.93
14	1.726	1.156	1.141	0.375
	43.84	29.36	28.97	9.53
16	1.866	1.281	1.203	0.500
	47.40	32.54	30.56	12.70
18	1.866	1.391	1.426	0.625
	47.40	35.33	36.22	15.88
20	2.040	1.531	1.426	0.625
	51.81	38.89	36.22	15.88
22	2.040	1.656	1.567	0.750
	51.81	42.06	39.80	19.05
24	2.178	1.777	1.735	0.800
	55.32	45.14	44.07	20.32

Plugs

16P

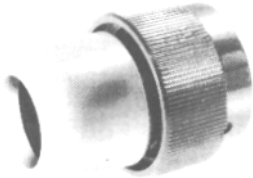

62GB-16P
MIL-C26482 MS3116P

For potted seal. Supplied complete with detachable potting mould and location ring.

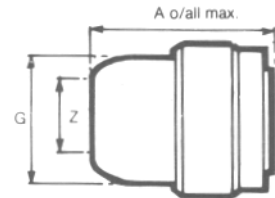

Shell Size	A max	C max	G max	Z min
08	1.306 33.17	0.750 19.05	0.572 14.53	0.260 6.60
10	1.415 35.94	0.859 21.82	0.666 16.92	0.463 11.76
12	1.384 35.15	1.031 26.19	0.822 20.88	0.557 14.14
14	1.384 35.15	1.156 29.36	0.907 23.04	0.590 14.99
16	1.384 35.15	1.281 32.54	1.040 26.41	0.713 18.11
18	1.384 35.15	1.391 35.33	1.165 29.59	0.835 22.21
20	1.539 39.09	1.531 38.89	1.285 32.64	1.015 25.78
22	1.539 39.09	1.656 42.06	1.400 35.56	1.015 25.78
24	1.602 40.69	1.777 45.14	1.540 39.12	1.265 32.13

16J

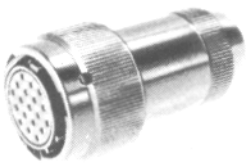

62GB - 16J

Plug with cable clamp for unscreened jacketed cable. No grommet supplied.

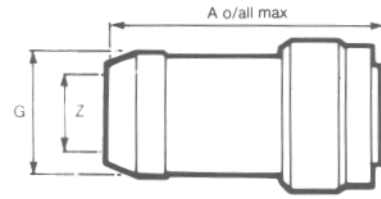
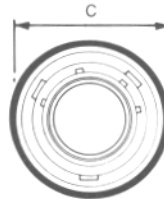

Shell Size	A max	C max	G max	Z min	Z max
08	1.836 46.64	0.750 19.05	0.561 14.25	0.168 4.28	0.230 5.84
10	1.836 46.64	0.859 21.82	0.686 17.43	0.205 5.21	0.312 7.93
12	1.937 49.20	1.031 26.19	0.811 20.60	0.388 8.59	0.442 11.23
14	2.137 54.28	1.156 29.36	0.936 23.78	0.416 10.57	0.539 13.69
16	2.337 59.36	1.281 32.54	1.061 26.95	0.550 13.97	0.616 15.65
18	2.537 64.45	1.391 35.33	1.186 30.13	0.600 15.24	0.672 17.07
20	2.758 70.05	1.531 38.89	1.311 33.30	0.635 16.13	0.747 18.98
22	2.958 75.13	1.656 42.06	1.436 36.75	0.670 17.02	0.846 21.49
24	3.002 76.25	1.777 45.14	1.561 39.65	0.740 18.80	0.894 22.71

Plugs

5039



62GB-5039-10

SD/C 235 155 - X
SD/C 235 156 - X

Low profile, solder termination plug with 90° screened cable outlet.

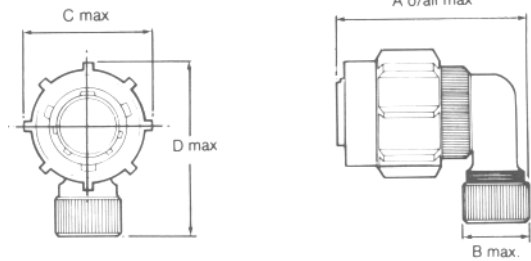

Shell Size	A max	B max	C max	D max
10	1.473 37.41	0.500 12.70	0.980 24.89	1.500 38.10

5055

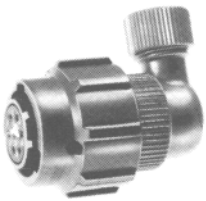

62GB-5055-10

SD/2 235 193 - X

Low profile solder termination plug with size 12 90° screened cable outlet.

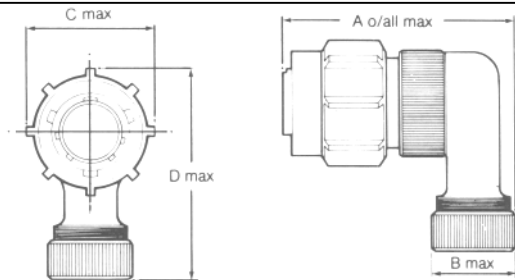

Shell Size	A max	B max	C max	D max
10	1.800 45.72	0.655 16.64	0.980 24.89	1.800 45.72

5056



62GB-5056-10

Audio plug with solder termination

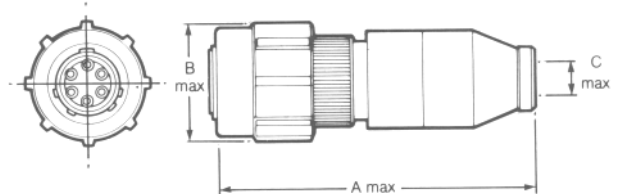

Shell Size	A max	B max	C max
10	2.375 60.33	0.979 / 0.969 24.87 / 24.61	0.310 7.87

Plugs

5074

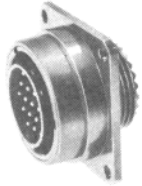

62GB-5074

Flange mounting push/pull plug with threaded shell to accept standard cable accessories.

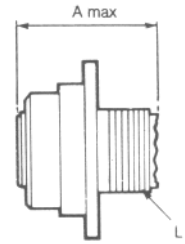
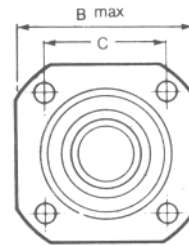

Shell Size	A max	B max	C	L
10	0.912 23.17	1.125 28.57	0.866 22.00	9/16 - 24 NEF
12	0.912 23.17	1.218 30.93	0.969 24.61	9/16 - 24 NEF
14	0.912 23.17	1.312 33.32	1.062 26.97	9/16 - 24 NEF

Insert Orientations

For M I L-C-26482 and for replacement purposes in BS9522 FOO 17

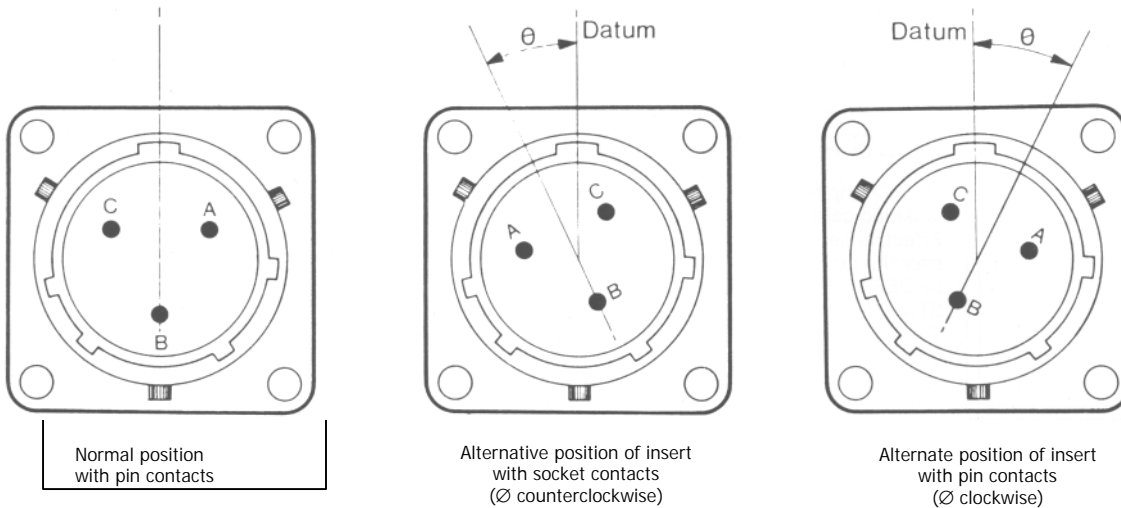

Each diagram shows mating face of insert.

Insert Arrangement	Normal	Orientation θ (degrees)			
		W	X	Y	Z
8-2	0	58	122	-	-
8-3	0	60	210	-	-
8-33	0	90	-	-	-
8-4	0	45	-	-	-
8-98	0	-	-	-	-
10-2	0	-	-	-	-
10-6	0	90	-	-	-
10-7	0	-	-	-	-
12-3	0	-	-	180	-
12-10	0	60	155	270	295
14-5	0	40	92	184	273
14-12	0	43	90	-	-
14-15	0	17	110	155	234
14-19	0	30	165	315	-
16-18	0	54	152	180	331
16-23	0	158	270	-	-
16-26	0	60	-	275	338
18-11	0	62	119	241	340
18-32	0	85	138	222	265
20-16	0	238	318	333	347
20-41	0	45	126	225	-
22-21	0	16	135	175	349
22-55	0	30	142	226	314
24-61	0	90	180	270	324

Key/Keyway Orientations

For BS9522 F0017

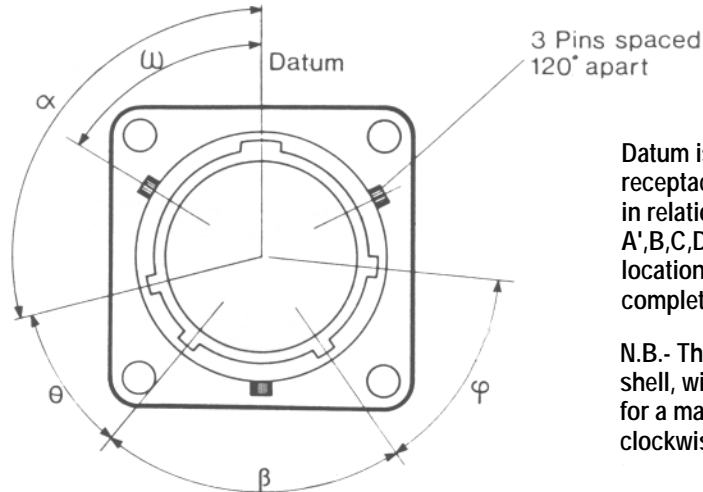

Datum is always taken from major key or keyway. In receptacles the major keyway always remains fixed in relation to the mounting flange. For the A',B,C,D',E and F orientations, the three bayonet locations and associated minor keyways are rotated complete, in accordance with the table below.

N.B.- The accompanying diagram shows a receptacle shell, with keyways. Corresponding key orientations for a mating plug shell are therefore always clockwise.

Shell Size	Values for ω (degrees)							Values for θ (degrees)						Values for β (degrees)							
	N	A*	B	C	D*	E	F	N	A*	B	C	D*	E	F	N	A*	B	C	D*	E	F
8	105	92	-	-	118	118	82	35	35	-	-	35	30	50	75	75'	-	-	75	100	75
10	105	95	85	125	115	115	85	35	35	35	35	35	30	50	75	75	75	75	75	100	75
12	105	97	89	121	113	115	85	35	35	35	35	35	30	50	75	75	75	75	75	100	75
14	105	98	91	119	112	75	120	35	35	35	35	35	30	50	75	75	75	75	75	100	75
16	105	99	93	117	111	75	120	35	35	35	35	35	30	50	75	75	75	75	75	100	75
18	105	100	95	115	110	75	120	35	35	35	35	35	30	50	75	75	75	75	75	100	75
20	105	100	95	115	110	75	120	35	35	35	35	35	30	50	75	75	75	75	75	100	75
22	105	101	97	113	109	75	120	35	35	35	35	35	30	50	75	75	75	100	75	75	75
24	105	101	97	113	109	75	120	35	35	35	35	35	30	50	75	75	75	75	75	100	75

Shell Size	Values for φ (degrees) Orientation							Values for ω (degrees) Orientation						
	N	A*	B	C	D*	E	F	N	A*	B	C	D*	E	F
8	50	50	50	50	50	30	45	60	47	-	-	73	73	47
10	50	50	50	50	50	30	45	60	50	40	80	70	70	50
12	50	50	50	50	50	30	45	60	52	44	76	68	70	50
14	50	50	50	50	50	30	35	60	53	46	74	67	30	75
16	50	50	50	50	50	30	35	60	54	48	72	66	30	75
18	50	50	50	50	50	30	35	60	55	50	70	65	30	75
20	50	50	50	50	50	30	35	60	55	50	70	65	30	75
22	50	50	50	50	50	30	35	60	56	52	68	64	30	75
24	50	50	50	50	50	30	35	60	56	52	68	64	30	75

* now inactive for new designs but available for replacement purposes. Superseded in BS9522 F0017 by orientations E and F.

X-ON Electronics

Largest Supplier of Electrical and Electronic Components

Click to view similar products for [amphenol manufacturer](#):

Other Similar products are found below :

[10-507142-843](#) [GTS02R20-15P-025-116](#) [ACC02E28-51S-003-B30-LC](#) [TV06RL-13-35SD-LC](#) [TV06RL-13-35SD](#) [TV06RL-13-98SD-LC](#)
[TV06RL-13-98SD](#) [TVP00RW-23-53AD](#) [100-007-213-002-001](#) [TV06RW-25-90AE](#) [97-3108B16S-5PW-417](#) [PT06J20-24SW](#) [97-3108B16S-4PY-417](#) [97-3108B16S-4PX-417](#) [97-3108B16S-5PY-417](#) [97-3108B16S-4PW-417](#) [CS-DSDMDB37MF-025](#) [97-3108B16S-5PZ-417](#)
[TV06RW-25-46AE](#) [TVS07RF-21-16AA](#) [TVS07RF-21-39BA](#) [GTC02R32-17S-025-RDS](#) [GTC06-22-13SW](#) [GTC06-22-13SX-025-B30](#)
[GTC06-22-13SW-025-B30](#) [GTC06-22-13SW-025-B30-LC](#) [GTC06-22-13SX-025-LC](#) [GTC06-22-13SY-025-B30-LC](#) [GTC06-22-13SY-025-LC](#) [97-3101A20-21P-958](#) [97-3106A18-3PX-958](#) [97-3106A18-3PY-958](#) [GTC06-36-7S-LC](#) [GTS08-36-22PZ-025-B30](#) [CTV07RW-11-99AD](#)
[PT00SP2241P](#) [GTS01-16-10S-116](#) [TVS07RF-25-43AB](#) [GTS030A20-4S-025-116](#) [GTS030A20-4SW-025-116](#) [GTS030A20-4SX-025-116](#)
[LJT06RT-15-35PB\(023\)](#) [LJT06RT-15-68PB-023](#) [GTS030A20-4SY-025-116](#) [JTP02RE-16-55P\(023\)](#) [TVS07RF-21-11BA](#) [PT06A14-4S-005](#)
[TVS06RF-17-99BD](#) [97-3106A-22-9S\(621\)](#) [GTC06-22-13S-025-B30-LC](#)