



Custom High Performance Cooling Solutions w/ maxiGRIP™ Attachment

ATS PART # ATS-59006-C2-R0

Features & Benefits

- » Designed for flip-chip processors such as Freescale MPCs
- » maxiGRIP™ attachment applies steady, even pressure to the component and does not require holes in the PCB
- » Comes preassembled with high performance, phase changing, thermal interface material

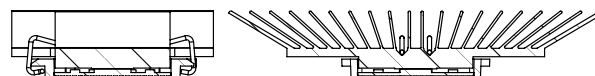
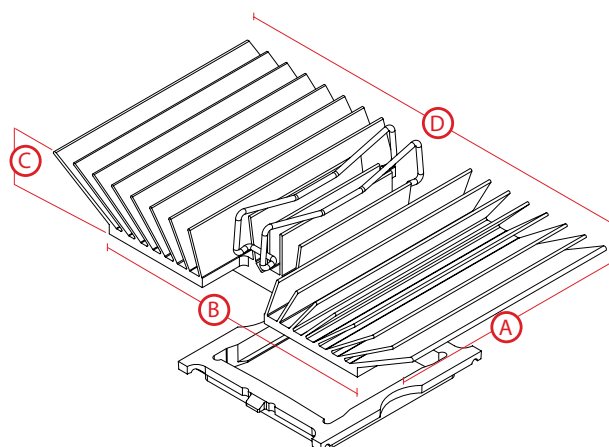

**Image above is for illustration purposes only.*

Thermal Performance

AIR VELOCITY

THERMAL RESISTANCE

FT/MIN	M/S	°C/W (UNDUCTED FLOW)	°C/W (DUCTED FLOW)
200	1.0	6.2	3.8
300	1.5	4.9	
400	2.0	4.2	
500	2.5	3.7	
600	3.0	3.3	
700	3.5	3	
800	4.0	2.8	

Product Details

DIMENSION A	DIMENSION B	DIMENSION C	DIMENSION D	INTERFACE MATERIAL	FINISH
29 mm	37 mm	11 mm	54 mm	SAINT-GOBAIN C1100F	BLACK-ANODIZED

NOTES:

- 1) Dimension C = heat sink height from bottom of the base to the top of the fin field.
- 2) ATS-59006-C1-R0 is a substitute item available utilizing an equivalent phase change material (Chomerics T766).
- 3) Thermal performance data are provided for reference only. Actual performance may vary by application.
- 4) ATS reserves the right to update or change its products without notice to improve the design or performance.
- 5) Contact ATS to learn about custom options available.



ATS ADVANCED THERMAL SOLUTIONS, INC.
Innovations in Thermal Management®

For more information, to find a distributor or to place an order, visit www.qats.com or call: 781.769.2800 (North America); +31 (0) 3569 84715 (Europe).

X-ON Electronics

Largest Supplier of Electrical and Electronic Components

Click to view similar products for advanced thermal solutions manufacturer:

Other Similar products are found below :

[ATS-52300B-C2-R0](#) [MGT270](#) [CS-12SHSS-A](#) [ATS-HP-F5L100S30W-031](#) [CS-95SHS-A](#) [TLC-100-DIST](#) [PTM-1000-030](#) [ATS-FM-66](#)
[tvLYT](#) [ATVS-2020-8](#) [eATVS-4](#) [MGT350](#) [MGT310](#) [ATS-58000-C1-R0](#) [eATVS-8](#) [ATS-EXL70-300-R0](#) [ATS-X50425G-C1-R0](#) [ATS-](#)
[EXL105-300-R0](#) [ATS-EXL100-300-R0](#) [ATS-TMDK-96](#) [ATS-CP-1003](#) [ATS-EXL62-1220-R0](#) [ATS-EXL60-1220-R0](#) [CS-9S6SS-A](#) [ATS-](#)
[EXL63-300-R0](#) [ATS-TCP-1002](#) [MGT290](#) [ATS-EXL110-1220-R0](#) [ATS-EXL105-1220-R0](#) [ATS-EXL2-254-R0](#) [ATS-EXL312-300-R0](#) [ATS-](#)
[EXL113-300-R0](#) [ATS-EXL119-300-R0](#) [ATS-TCP-1000](#) [MIC 1000-20](#) [ATS-EXL103-300-R0](#) [ATS-1039-C3-R0](#) [ATS-EXL100-1220-R0](#)
[ATS-EXL75-1220-R0](#) [ATS-EXL66-1220-R0](#) [ATS-FM-22](#) [MGT450](#) [ATS-EXL58-1220-R0](#) [ATS-EXL65-1220-R0](#) [ATS-EXL99-1220-R0](#)
[MGT425](#) [ATS-1040-C1-R0](#) [ATS-54325R-C1-R0](#) [MGT400](#) [ATSEU-077D-C1-R0](#)