

MDSTB 2,5/ 8-G1-5,08

Order No.: 1762431

The figure shows a 10-position version of the product

<http://eshop.phoenixcontact.net/phoenix/treeViewClick.do?UID=1762431>Header, Nominal current: 10 A, Nom. voltage: 250 V, Pitch: 5.08 mm,
Number of positions: 8, Color: green, Assembly: Soldering

Commercial data

EAN	4017918031039
Pack	50 pcs.
Customs tariff	85366990
Weight/Piece	0.014236 KG
Catalog page information	Page 261 (CC-2009)

Product notes

WEEE/RoHS-compliant since:
01/01/2003

<http://www.download.phoenixcontact.com>
Please note that the data given here has been taken from the online catalog. For comprehensive information and data, please refer to the user documentation. The General Terms and Conditions of Use apply to Internet downloads.

Technical data

Dimensions / positions

Pitch	5.08 mm
Dimension a	35.56 mm
Number of positions	8
Pin dimensions	1 x 1 mm
Hole diameter	1.4 mm

Technical data

Insulating material group	I
Rated surge voltage (III/3)	4 kV
Rated surge voltage (III/2)	4 kV
Rated surge voltage (II/2)	4 kV
Rated voltage (III/2)	320 V
Rated voltage (II/2)	630 V
Connection in acc. with standard	EN-VDE
Nominal current I_N	10 A
Nominal voltage U_N	250 V
Maximum load current	10 A (per position)
Insulating material	PA
Inflammability class acc. to UL 94	V0

Certificates / Approvals



Certification CB, CSA, CUL, GOST, UL, VDE-PZI

CSA

Nominal voltage U_N	300 V
Nominal current I_N	10 A

CUL

Nominal voltage U_N	300 V
Nominal current I_N	10 A

UL

Nominal voltage U_N	300 V
Nominal current I_N	10 A

Accessories

Item	Designation	Description
Assembly		
1755477	MSTB-BL	Keying cap, for forming sections, plugs onto header pin, green insulating material
Marking		
0804293	SK 5,08/3,8:FORTL.ZAHLEN	Marker card, printed horizontally, self-adhesive, 12 identical decades marked 1-10, 11-20 etc. up to 91-(99)100, sufficient for 120 terminal blocks
Plug/Adapter		
1734401	CR-MSTB	Coding section, inserted into the recess in the header or the inverted plug, red insulating material

Additional products

Item	Designation	Description
General		
1872758	A-ICV 2,5/ 8-G-5,08	Base strip, Nominal current: 12 A, Nominal voltage: 250 V, Mounting type: DIN rail mounting, Number of positions: 8, Pitch: 5.08 mm, Color: green
1873113	FKC 2,5/ 8-ST-5,08	Plug component, Nominal current: 12 A, Nom. voltage: 250 V, Pitch: 5.08 mm, Number of positions: 8, Connection type: Spring-cage conn., Color: green
1902178	FKCT 2,5/ 8-ST-5,08	Plug component, Nominal current: 12 A, Nom. voltage: 250 V, Pitch: 5.08 mm, Number of positions: 8, Connection type: Spring-cage conn., Color: green
1874015	FKCVR 2,5/ 8-ST-5,08	Plug component, Nominal current: 12 A, Nom. voltage: 250 V, Pitch: 5.08 mm, Number of positions: 8, Connection type: Spring-cage conn., Color: green
1873715	FKCVW 2,5/ 8-ST-5,08	Plug component, Nominal current: 12 A, Nom. voltage: 250 V, Pitch: 5.08 mm, Number of positions: 8, Connection type: Spring-cage conn., Color: green
1777345	FRONT-MSTB 2,5/ 8-ST-5,08	Plug component, Nominal current: 12 A, Nom. voltage: 250 V, Pitch: 5.08 mm, Number of positions: 8, Connection type: Screw connection, Color: green
1786462	IC 2,5/ 8-G-5,08	Header, Nominal current: 12 A, Nom. voltage: 320 V, Pitch: 5.08 mm, Number of positions: 8, Color: green, Assembly: Soldering
1786006	ICV 2,5/ 8-G-5,08	Header, Nominal current: 12 A, Nom. voltage: 320 V, Pitch: 5.08 mm, Number of positions: 8, Color: green, Assembly: Soldering

1757077	MSTB 2,5/ 8-ST-5,08	Plug component, Nominal current: 12 A, Nom. voltage: 250 V, Pitch: 5.08 mm, Number of positions: 8, Connection type: Screw connection, Color: green
1764235	MSTB 2,5/ 8-STZ-5,08	Plug component, Nominal current: 12 A, Nom. voltage: 250 V, Pitch: 5.08 mm, Number of positions: 8, Connection type: Screw connection, Color: green
1808874	MSTBC 2,5/ 8-ST-5,08	Plug component, Nominal current: 12 A, Nom. voltage: 320 V, Pitch: 5.08 mm, Number of positions: 8, Connection type: Crimp connection, Color: green
1809569	MSTBC 2,5/ 8-STZ-5,08	Plug component, Nominal current: 12 A, Nom. voltage: 320 V, Pitch: 5.08 mm, Number of positions: 8, Connection type: Crimp connection, Color: green
1769078	MSTBP 2,5/ 8-ST-5,08	Plug component, Nominal current: 12 A, Nom. voltage: 250 V, Pitch: 5.08 mm, Number of positions: 8, Connection type: Screw connection, Color: green
1781043	MSTBT 2,5/ 8-ST-5,08	Plug component, Nominal current: 12 A, Nom. voltage: 250 V, Pitch: 5.08 mm, Number of positions: 8, Connection type: Screw connection, Color: green
1792304	MVSTBR 2,5/ 8-ST-5,08	Plug component, Nominal current: 12 A, Nom. voltage: 250 V, Pitch: 5.08 mm, Number of positions: 8, Connection type: Screw connection, Color: green
1792812	MVSTBW 2,5/ 8-ST-5,08	Plug component, Nominal current: 12 A, Nom. voltage: 250 V, Pitch: 5.08 mm, Number of positions: 8, Connection type: Screw connection, Color: green
1883310	QC 1/ 8-ST-5,08	Plug component, Nominal current: 10 A, Nom. voltage: 500 V, Pitch: 5.08 mm, Number of positions: 8, Connection type: Insulation displacement connection QUICKON, Color: green
1826348	SMSTB 2,5/ 8-ST-5,08	Plug component, Nominal current: 12 A, Nom. voltage: 250 V, Pitch: 5.08 mm, Number of positions: 8, Connection type: Screw connection, Color: green
1853078	TMSTBP 2,5/ 8-ST-5,08	Plug component, Nominal current: 12 A, Nom. voltage: 250 V, Pitch: 5.08 mm, Number of positions: 8, Connection type: Screw connection, Color: green

Diagrams/Drawings

Drilling plan/solder pad geometry

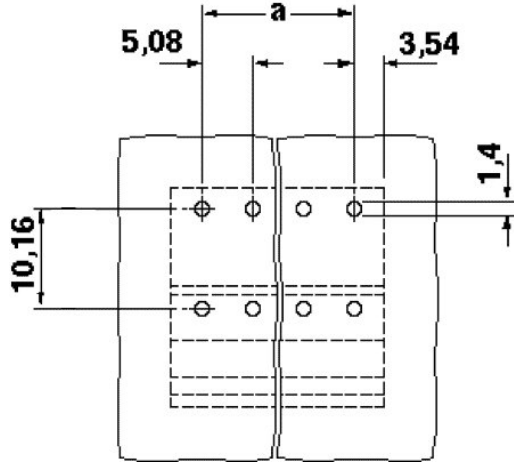

Dimensioned drawing

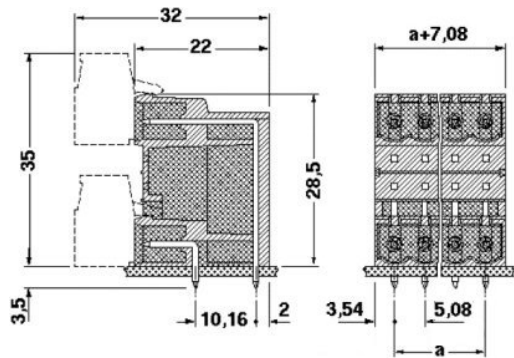

Address

PHOENIX CONTACT GmbH & Co. KG
Flachsmarktstr. 8
32825 Blomberg, Germany
Phone +49 5235 3 00
Fax +49 5235 3 41200
<http://www.phoenixcontact.com>



© 2010 Phoenix Contact
Technical modifications reserved;

X-ON Electronics

Largest Supplier of Electrical and Electronic Components

Click to view similar products for [FFC & FPC Connectors](#) category:

Click to view products by [Phoenix Contact](#) manufacturer:

Other Similar products are found below :

[HFW11R-1STE1H1LF](#) [FH29B-100S-0.2SHW\(99\)](#) [FA5S008HP1](#) [FH29B-120S-0.2SHW\(99\)](#) [FH29B-80S-0.2SHW\(99\)](#) [FHS-16](#) [FPH-2022G](#)
[52610-1075](#) [52610-1275](#) [52610-1934](#) [XF3M\(1\)-1415-1B-R100](#) [501864-3091-TR225](#) [0525594033](#) [086210010340800](#) [086222026001800](#)
[52271-2869-CUT-TAPE](#) [62674-201121DLF](#) [62684-36210E9ALF](#) [52610-1675](#) [52746-1671-TR250](#) [10051922-2810EHLF](#) [6-520415-9](#)
[BD021-09A-A1-0350-0200-0550-LD](#) [SFV6R-1STE9HLF](#) [XF3M-2915-1B-R100](#) [1658549-1](#) [62674-221121ALF](#) [46214008010800](#)
[046298003000883](#) [151660622](#) [842-816-2630-035](#) [AYF530665TA](#) [AYF351525](#) [046296011930846+](#) [AYF352325A](#) [046254020000800+](#)
[FH19C-13S-0.5SH\(99\)](#) [FH39J-51S-0.3SHW\(99\)](#) [AYF355125A](#) [AYF530365TA](#) [FH29B-44S-0.2SHW\(99\)](#) [SFW5R-2STAE9LF](#) [AYF351125A](#)
[AYF350725A](#) [62684-502100AHLF](#) [FH39-61S-0.3SHW\(99\)](#) [AYF414035A](#) [10064555-172520HLF](#) [AYF212335A](#) [504754-2500](#)