

## SPTA 1/ 4-3,5

Order No.: 1752120

The illustration shows the 10-position version

<http://eshop.phoenixcontact.net/phoenix/treeViewClick.do?UID=1752120>

PC terminal block, Nominal current: 9 A, Nom. voltage: 160 V, Pitch: 3.5 mm, Number of positions: 4, Type of connection: Spring-cage conn., Assembly: Soldering, Conductor/PCB connection direction: 45 °, Color: green

### Commercial data

EAN	4046356320979
Pack	50 pcs.
Customs tariff	85369010
Weight/Piece	0.00426 KG
Catalog page information	Page 105 (CC-2009)

### Product notes

WEEE/RoHS-compliant since:  
10/02/2007

<http://www.download.phoenixcontact.com>  
Please note that the data given here has been taken from the online catalog. For comprehensive information and data, please refer to the user documentation. The General Terms and Conditions of Use apply to Internet downloads.

### Technical data

#### Dimensions / positions

Length	10 mm
Pitch	3.5 mm
Dimension a	10.5 mm

Number of positions	4
Pin dimensions	0,6 x 1,0 mm
Pin spacing	3.5 mm
Hole diameter	1.1 mm

**Technical data**

Insulating material group	I
Rated surge voltage (III/3)	2.5 kV
Rated surge voltage (III/2)	2.5 kV
Rated surge voltage (II/2)	2.5 kV
Rated voltage (III/2)	200 V
Rated voltage (II/2)	400 V
Connection in acc. with standard	EN-VDE
Nominal current $I_N$	9 A
Nominal voltage $U_N$	160 V
Nominal cross section	1 mm <sup>2</sup>
Maximum load current	9 A
Insulating material	PA
Inflammability class acc. to UL 94	V0
Stripping length	8 mm

**Connection data**

Conductor cross section solid min.	0.2 mm <sup>2</sup>
Conductor cross section solid max.	1.5 mm <sup>2</sup>
Conductor cross section stranded min.	0.2 mm <sup>2</sup>
Conductor cross section stranded max.	1 mm <sup>2</sup>
Conductor cross section stranded, with ferrule without plastic sleeve min.	0.25 mm <sup>2</sup>
Conductor cross section stranded, with ferrule without plastic sleeve max.	0.75 mm <sup>2</sup>
Conductor cross section stranded, with ferrule with plastic sleeve min.	0.25 mm <sup>2</sup>
Conductor cross section stranded, with ferrule with plastic sleeve max.	0.75 mm <sup>2</sup>
Conductor cross section AWG/kcmil min.	24
Conductor cross section AWG/kcmil max	16

**Certificates / Approvals**



Certification CUL, UL

**CUL**

Nominal voltage $U_N$	300 V
Nominal current $I_N$	10 A
AWG/kcmil	26-16

**UL**

Nominal voltage $U_N$	300 V
Nominal current $I_N$	10 A
AWG/kcmil	26-16

**Diagrams/Drawings**

Drilling plan/solder pad geometry

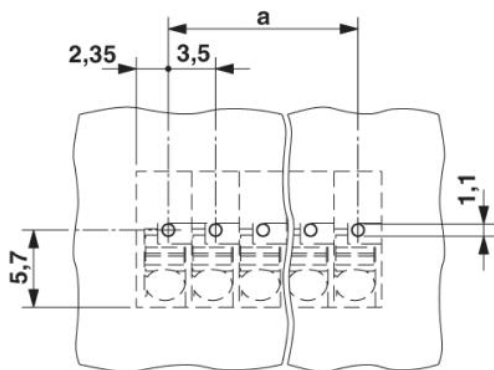

Dimensioned drawing

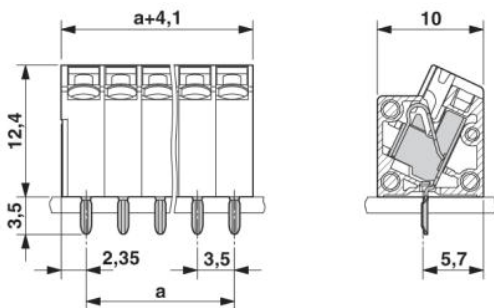

**Address**

PHOENIX CONTACT GmbH & Co. KG  
Flachsmarktstr. 8  
32825 Blomberg, Germany  
Phone +49 5235 3 00  
Fax +49 5235 3 41200  
<http://www.phoenixcontact.com>



© 2010 Phoenix Contact  
Technical modifications reserved;

## X-ON Electronics

Largest Supplier of Electrical and Electronic Components

*Click to view similar products for [phoenix contact manufacturer](#):*

Other Similar products are found below :

[1203259](#) [3240366](#) [1893300](#) [1623633](#) [2814605](#) [3240098](#) [0201391](#) [CRIMPFOX 16 S](#) [CRIMPSET 25](#) [7001438](#) [ETD-BL-1T-F-300S](#) [MCR-1CLP-I-I-00](#) [MCR-4CLP-I-I-00](#) [MCR-DAC 8-I- 4-BUS](#) [FL EPA WMS](#) [FLK 50/EZ-DR/ 400/KONFEK/S](#) [FLS PB M12 DO 8 M12-2A](#) [PPS CD BLADE](#) [PSI-MOS-DNET CAN/FO 660/BM](#) [PSM-ME-RS232/RS232-P](#) [PSM PTK-4](#) [PSM-SET-FSMA/4-KT](#) [PSR-SCP-24DC/TS/SDI8/SDIO](#) [PSR-SCP- 24DC/URD3/4X1/2X2](#) [PT 2X2- 5DC-ST](#) [1202580](#) [1203534](#) [1205985](#) [1206308](#) [1207420](#) [QUINT-BAT/24DC/12AH](#) [1204038](#) [1212041](#) [1212096](#) [1212162](#) [1212171](#) [1212202](#) [1212250](#) [1212304](#) [1212380](#) [1212480](#) [1212485](#) [1212488](#) [1212500](#) [1212511](#) [1212578](#) [1212584](#) [1212585](#) [1212592](#) [1212646](#)